

MOTOPLASTIC, S.A.

Molí de la sal, 1 - 08400 Granollers (Barcelona) SPAIN

Tel. 34 93 849 06 33 - Fax 34 93 849 09 88

info@motoplastic.com







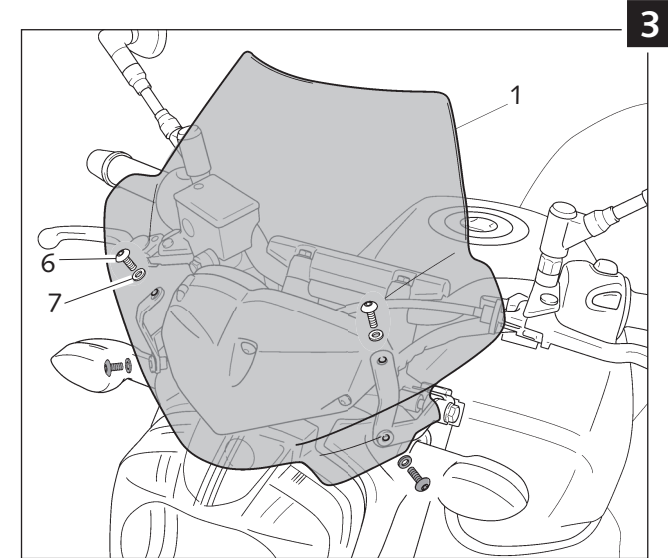
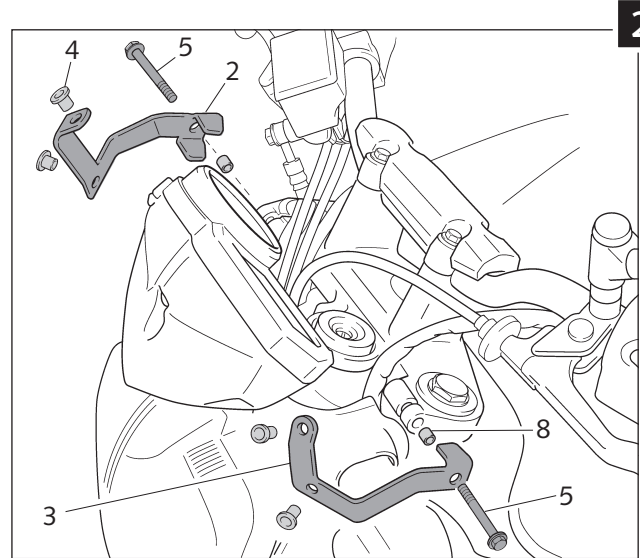
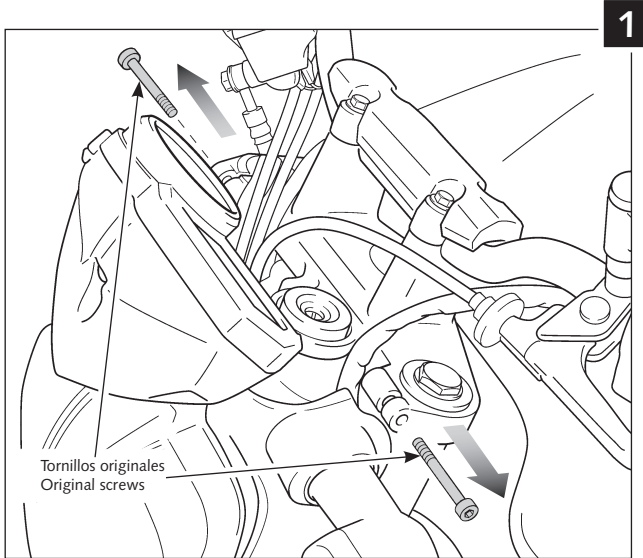

www.puig.tv

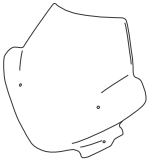
INSTRUCCIONES DE MONTAJE - MOUNTING INSTRUCTIONS

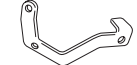
CARENABRÍS ADAPTABLE A - WINDSHIELD ADAPTABLE TO YAMAHA FZ6 S2 09'-10'

Ref.: 4511



ID.	DESCRIPCIÓN	DESCRIPTION	QTY.
1	 Pantalla	Screen	1
2	 Soporte derecho INOX	Right INOX bracket	1
3	 Soporte izquierdo INOX	Left INOX bracket	1
4	 Tuerca M5 con silemblock incorporado	M5 nut incorporated well nut	4
5	 Tornillo M8x40 DIN931	M8x40 DIN931 allen screw	2
6	 Tornillo M5x16 ISO 7380	M5x16 ISO 7380 screw	4
7	 Arandela nylon Ø5	Nylon washer Ø5	4
8	 Casquillo Ø ext. 14 x Ø int. 8.5 x 12	Metal arrowhead Ø outer 14 x Ø inner 8.5 x 12	2