



MODEL YAMAHA YZF R125
YAMAHA MT 125
LINE FULL SYSTEM

YEAR 2014-2016
2015-2016
MUFFLER GP

SCHEMATIC

ELENCO PARTI / PARTS LIST

#	QTÀ / QTY	DESCRIZIONE / DESCRIPTION	CODICE / CODE
1	1	DB killer / DB killer	50.DK.096.0
2	1	Silenziatore / Muffler	GP
3	1	Protezione per staffa / Protection for bracket	50.73.040.1
4	1	Staffa / Bracket	50.SS.032.0
5	2	Vite M6 x 16 / Screw M6 x 16	50.73.175.1
6	4	Rondella M6 / Washer M6	50.72.027.1
7	2	Dado M6 autobloccante / M6 locknut	50.73.112.1
8	1	Vite M8x45 / Screw M8x45	50.73.602.1
9	1	Rondella in alluminio / Aluminium washer	50.73.063.1
10	1	Distanziale in alluminio / Aluminium spacer	50.SS.143.1
11	4	Dado M8 flangiato / Flanged nut M8	50.73.393.1
12	1	Vite M8x16 / Screw M8x16	50.73.006.1
13	1	Rondella M8 / Washer M8	50.73.270.1
14	1	Tubo di raccordo / Link pipe	9773Y047S2B
15	1	Tubo di raccordo / Link pipe	9773Y047S2A
16	2	Tubo in gomma per molla / Rubber pipe for spring	50.73.210.1
17	1	Molla lunga / Long spring	50.71.080.1
18	1	Molla media / Middle spring	50.73.359.1

Catalytic Converter
Cod. ACC.033.A1
Optional for Y.047.L2S - Y.047.L6S - Y.047.LXB
Included in Y.047.K2S - Y.047.K6S - Y.047.KXB

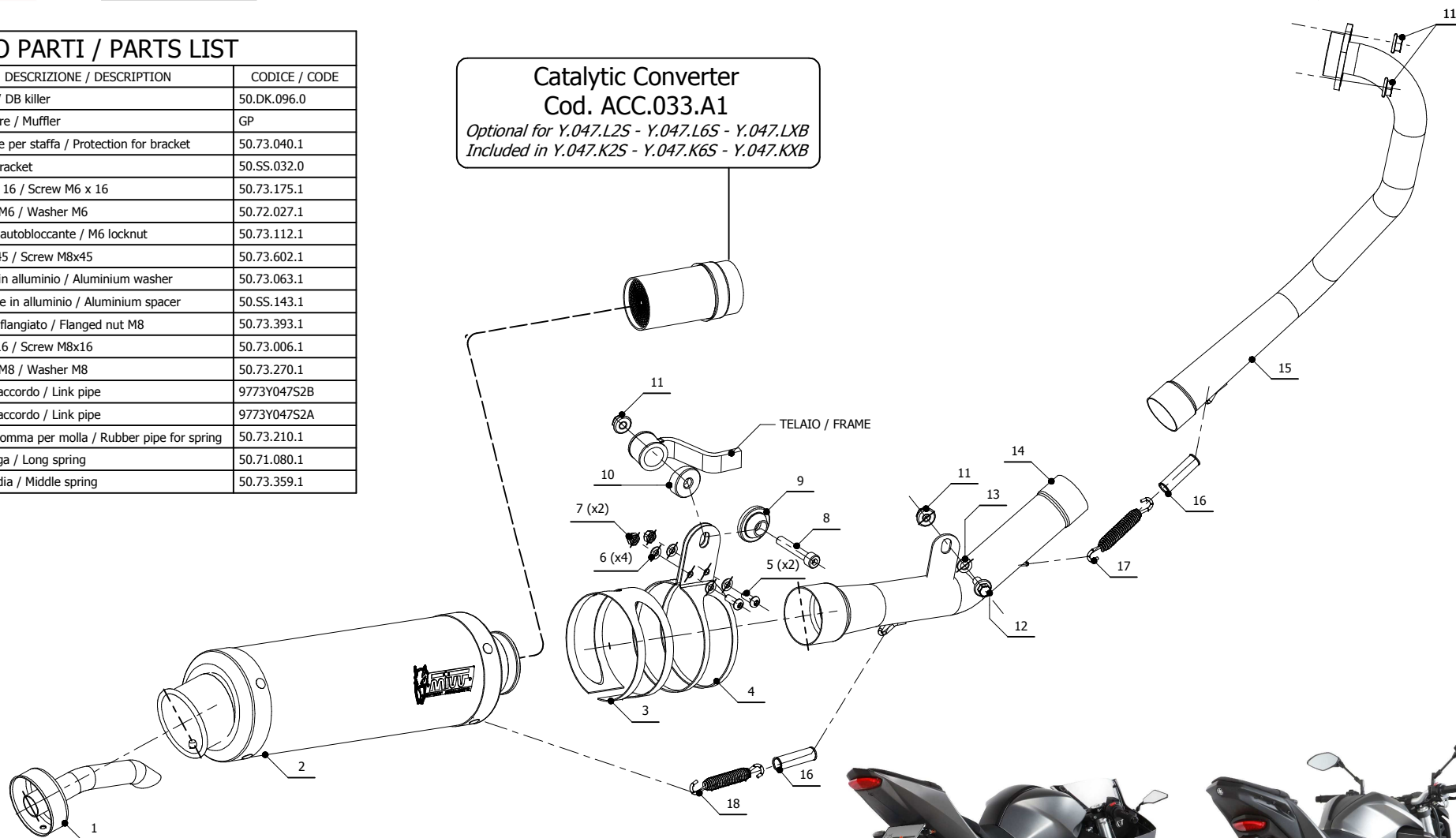

APPLICAZIONI / APPLICATIONS

CODICE / CODE	SILENZIATORE / MUFFLER	TUBO / PIPE	FASCETTA / CLAMP	NOTE
Y.047.L2S	CARBONIO / CARBON FIBER	INOX / ST. STEEL	INOX / ST. STEEL	CATALYTIC CONVERTER NOT INCLUDED
Y.047.L6S	TITANIO / TITANIUM			
Y.047.LXB	STEEL BLACK			
Y.047.K2S	CARBONIO / CARBON FIBER	INOX / ST. STEEL	INOX / ST. STEEL	CATALYTIC CONVERTER INCLUDED
Y.047.K6S	TITANIO / TITANIUM			
Y.047.KXB	STEEL BLACK			

