

BMW R NINE T

M O U N T I N G I N S T R U C T I O N S











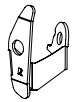

REF 9167

**ABS
FRONT PLATE**

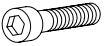
REF 9798

**ALUMINUM
FRONT PLATE**



ID.	PIEZA / PART	DESCRIPCIÓN	DESCRIPTION	QTY.	REF.:
1		Placa frontal ABS	ABS front plate	1	10526J/CM3
		Placa frontal ALUMINIO	ALUMINUM front plate		9807P/N
2		Soporte metálico derecho	Right metal support	1	SOPOR-2P-2-9167
3		Soporte metálico izquierdo	Left metal support	1	SOPOR-2P-2-9167
4		Silentblock M5	M5 silentblock	2	SILENBTM5-046/1
5		Casquillo Øint 8,5 x Øext 14x7,5	Øint 8,5 x Øext 14x7,5 arrowhead	2	CASQUI8147-0193
6		Tornillo M8x35 DIN912	M8x35 DIN912 screw	2	TORNI-AD912-196
7		Tornillo allen M5x16 Ø11 ISO 7380	M5x16 Ø11 ISO 7380 allen screw	2	TORNI-I7380-493
8		Arandela nylon M5x1	M5x1 nylon washer	2	ARNV0000000245
9		Tapón tornillo M5 ISO7380	M5 ISO7380 screw cap	2	TAPON-----85
10		Tornillo allen M5x16 Ø11 ISO 7380 (INOX)	M5x16 Ø11 ISO 7380 allen screw (INOX)	2	TORNI-IA----423
11		Separador de silicona Ø8x2 (Se suministra montado en ID2 y ID3)	Ø8x2 mm silicone tear (Supplied already mounted on item ID2 & ID3)	4	ADHESI-GT-D8---
12		Ribete autoadhesivo longitud de 190mm 6,2mmx2,6mm	Selft-autoadhesive trim lenght 190mm 6,2x2,6mm	1	PERFIL-PVC-1048
13		Kit adhesivos https://www.youtube.com/watch?v=lxEcdLZ58qg	Stickers set https://www.youtube.com/watch?v=lxEcdLZ58qg	1	10535

BMW R NINE T

INSTRUCCIONES DE MONTAJE - MOUNTING INSTRUCTIONS - MONTAGEANLEITUNG

1

**DISASSEMBLY
DESMONTAJE**

A Tornillería original
Original screws

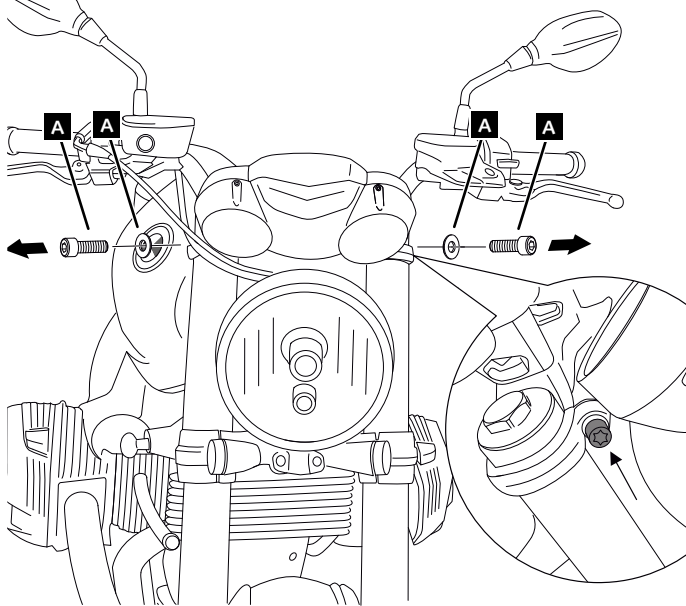

2

**ASSEMBLY
MONTAJE**

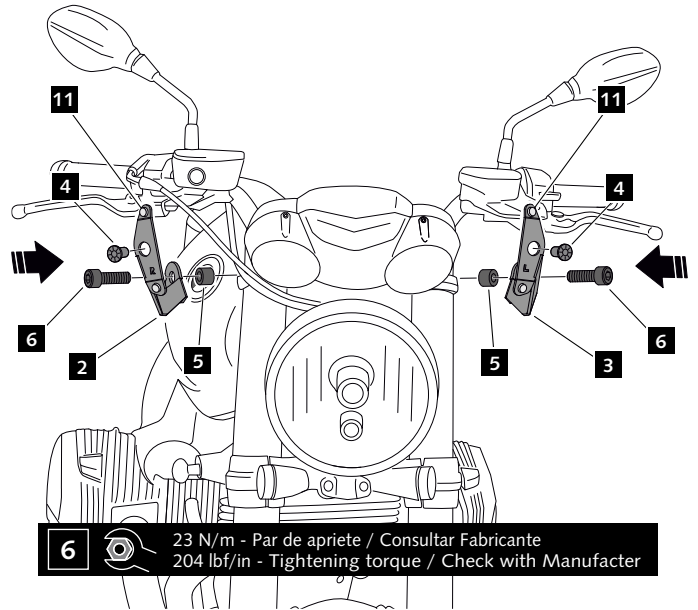

3

ALUMINUM

**ASSEMBLY
MONTAJE**

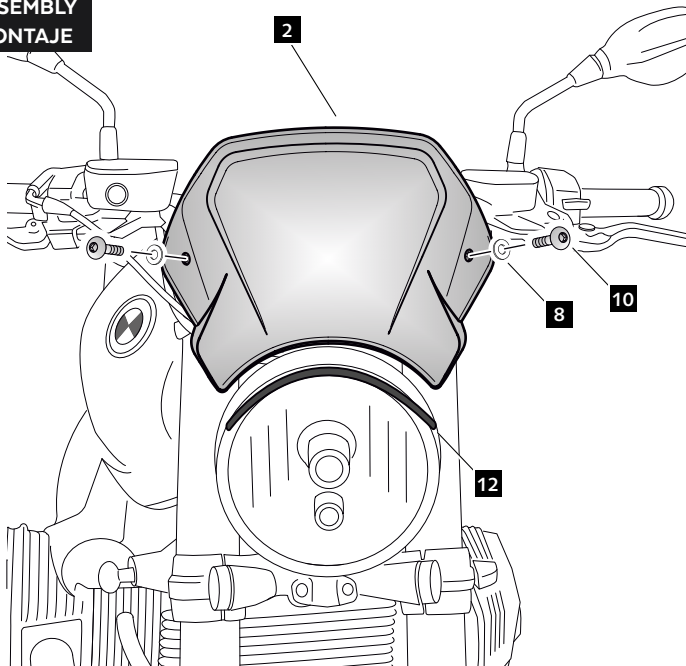

ABS

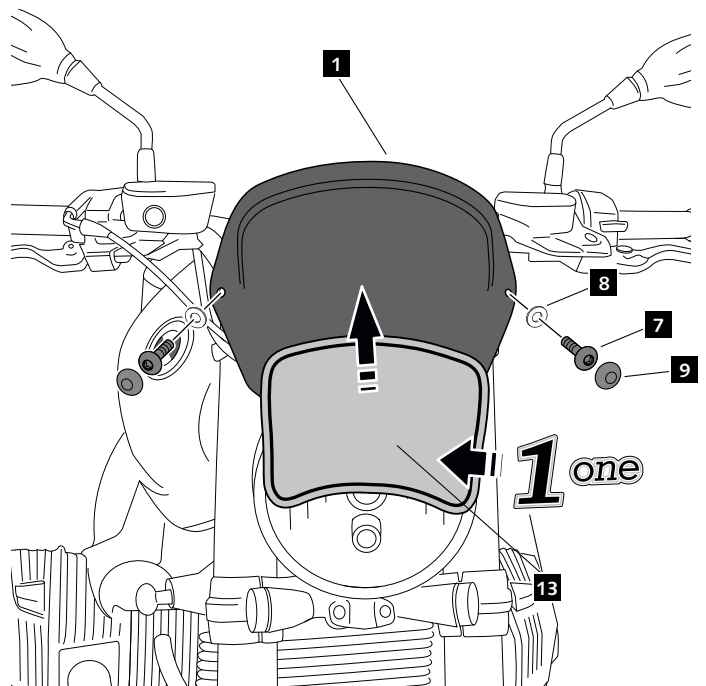

ID13 SOLO SE SUMINISTRA CON PLACA FRONTAL ABS
ONLY SUPPLIED WITH ABS FRONT PLATE