



EVOTECH®
P E R F O R M A N C E

www.evotech-performance.com

Triumph Tiger 900 Garmin Sat Nav Mount Installation Instructions



Kit Contents PRN014566-014925

- (A) 1 x Main Plate
- (B) 1 x Pivot Plate
- (C) 1 x Sub Mounting Bracket
- (D) 2 x M5 x 8mm Black Button Head Bolts
- (E) 2 x P-clips (No.1)
- (F) 2 x P-clips (No.2)
- (G) 2 x P-clips (No.3)
- (H) 2 x P-clips (No.4)
- (I) 2 x Lobe Screw
- (J) 2 x M5 Black Washer
- (K) 2 x Locking Washer
- (L) 2 x M4 x 5mm Black Button Head Bolts
- (M) 4 x M4 x 10mm Black Button Head Bolts
- Sub Kit
- (N) 2 x M5 x 35mm Caphead Bolt

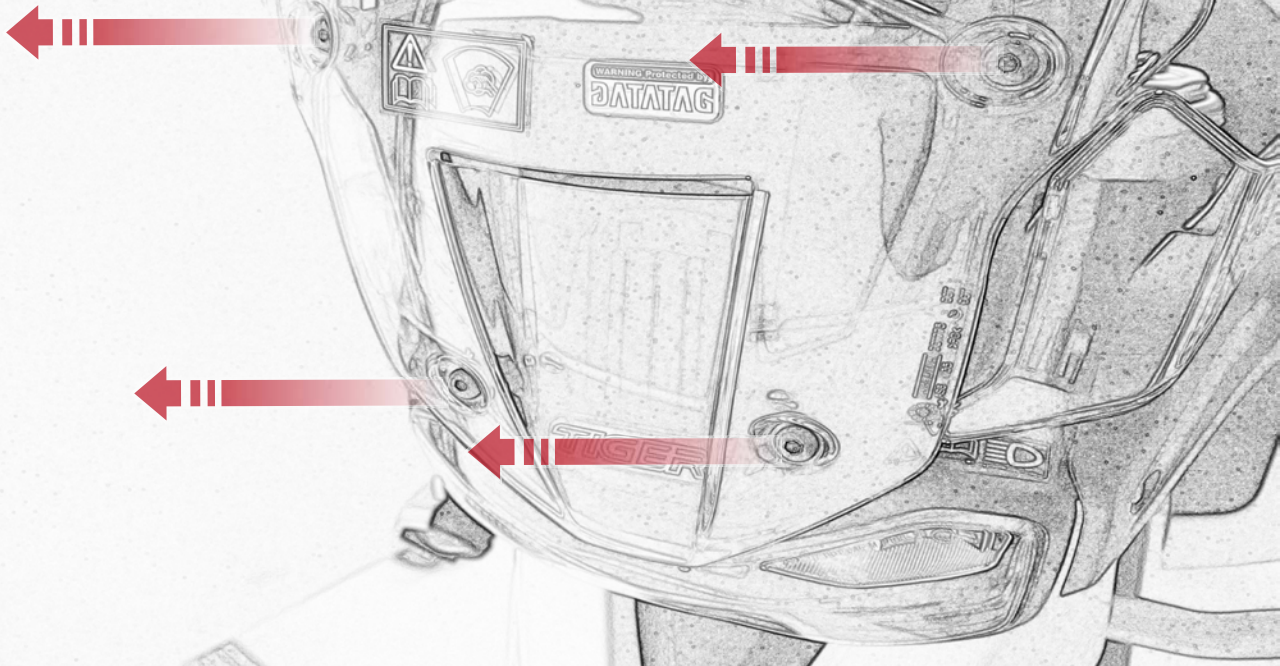

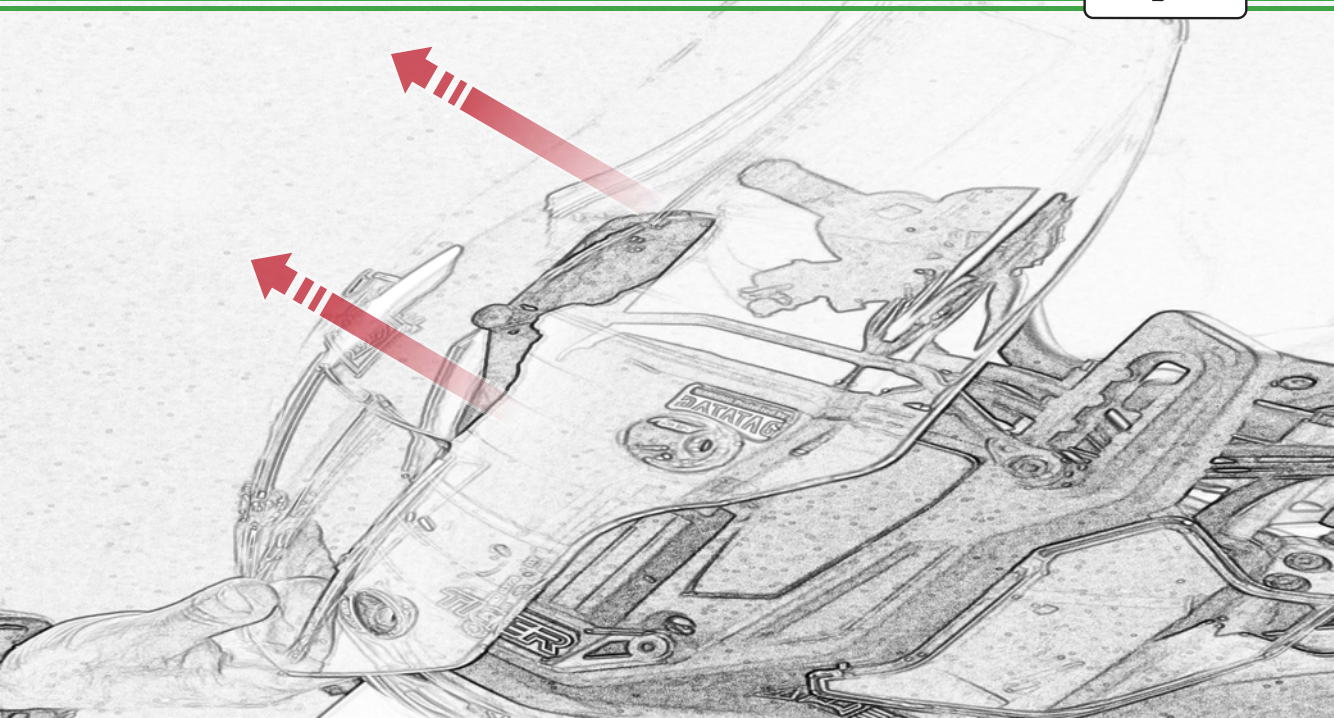

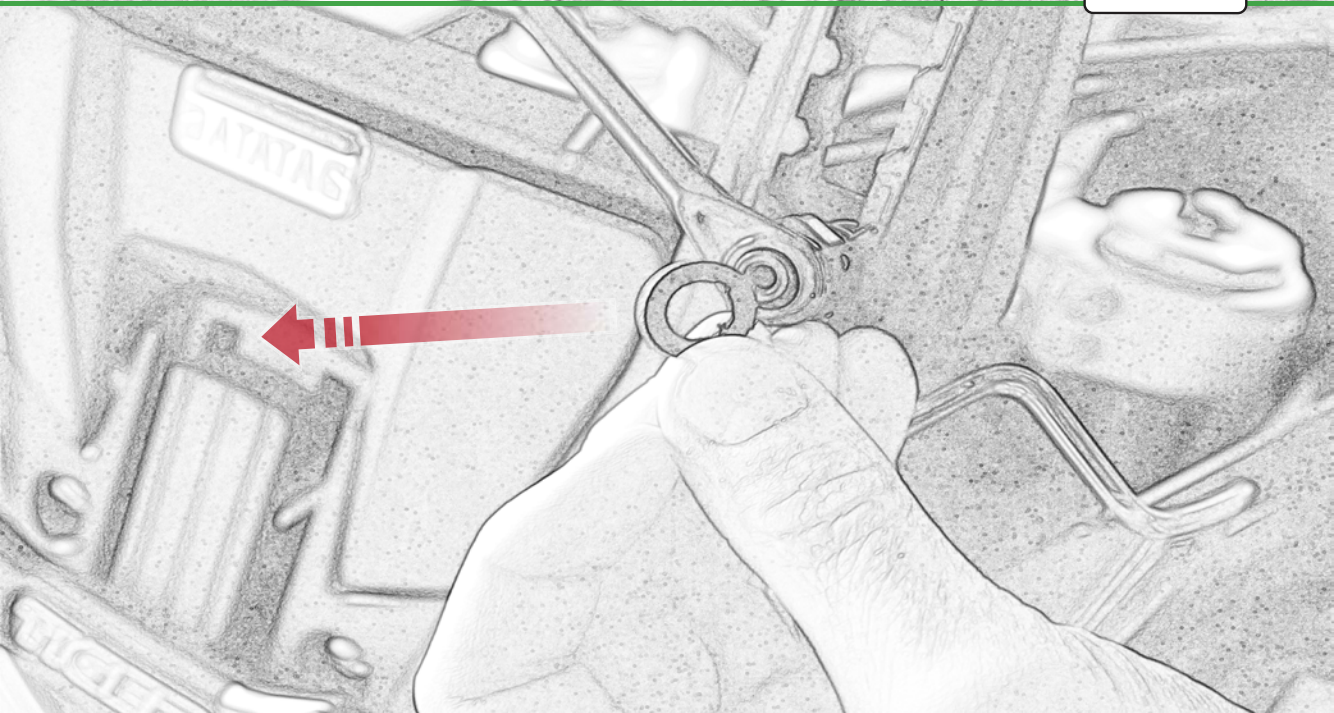



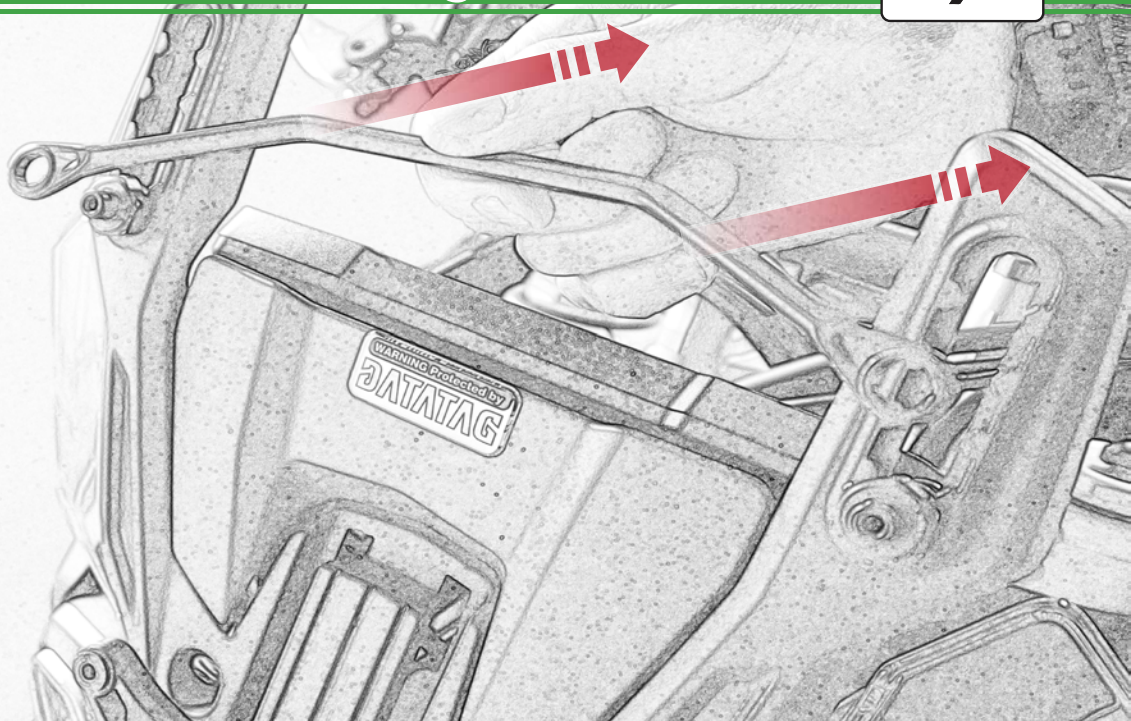

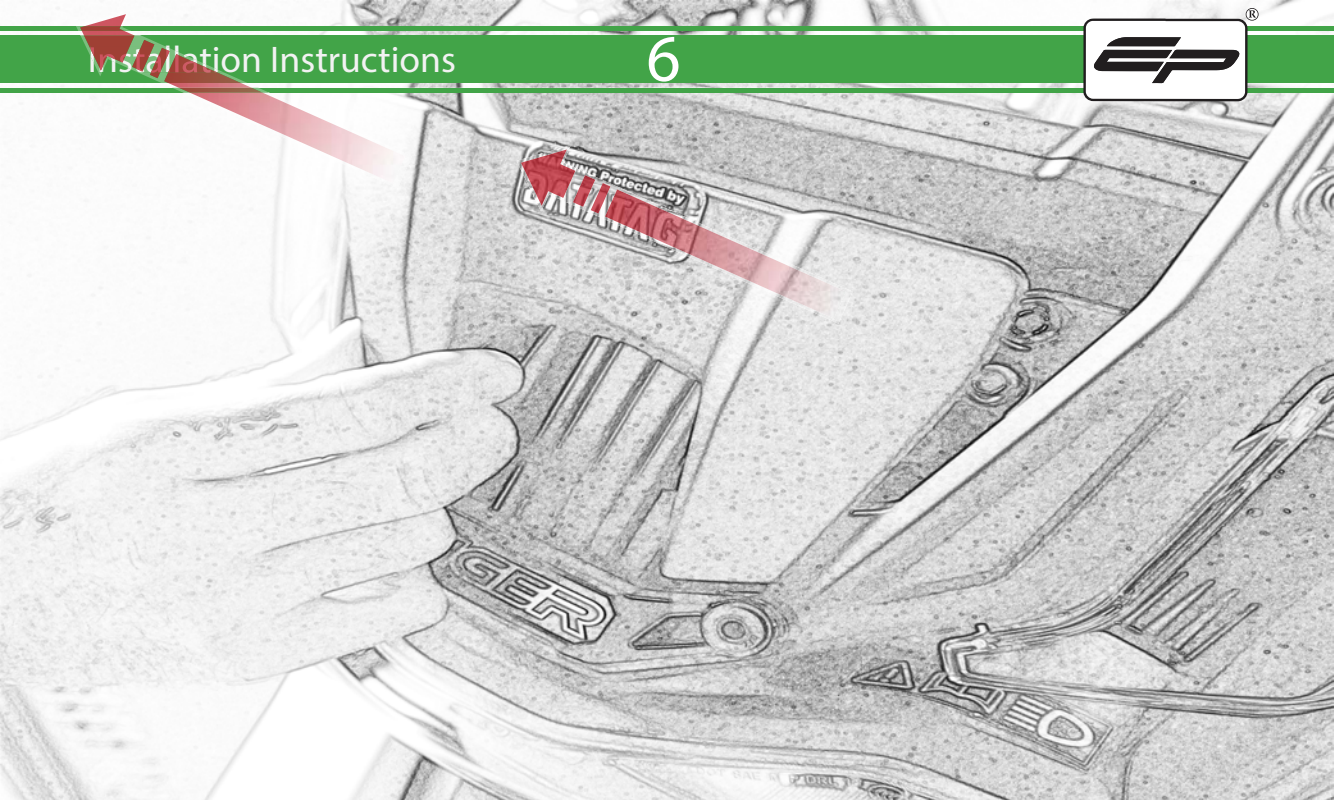

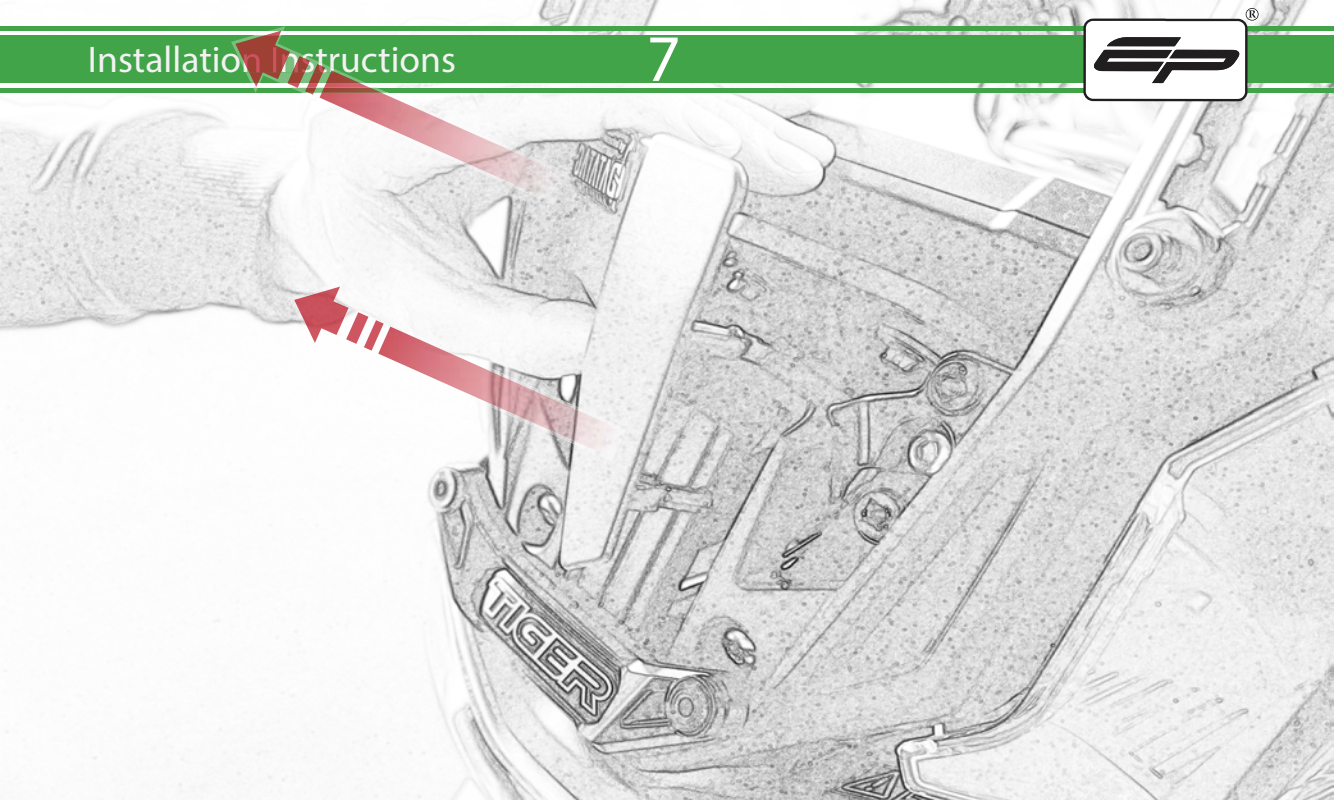

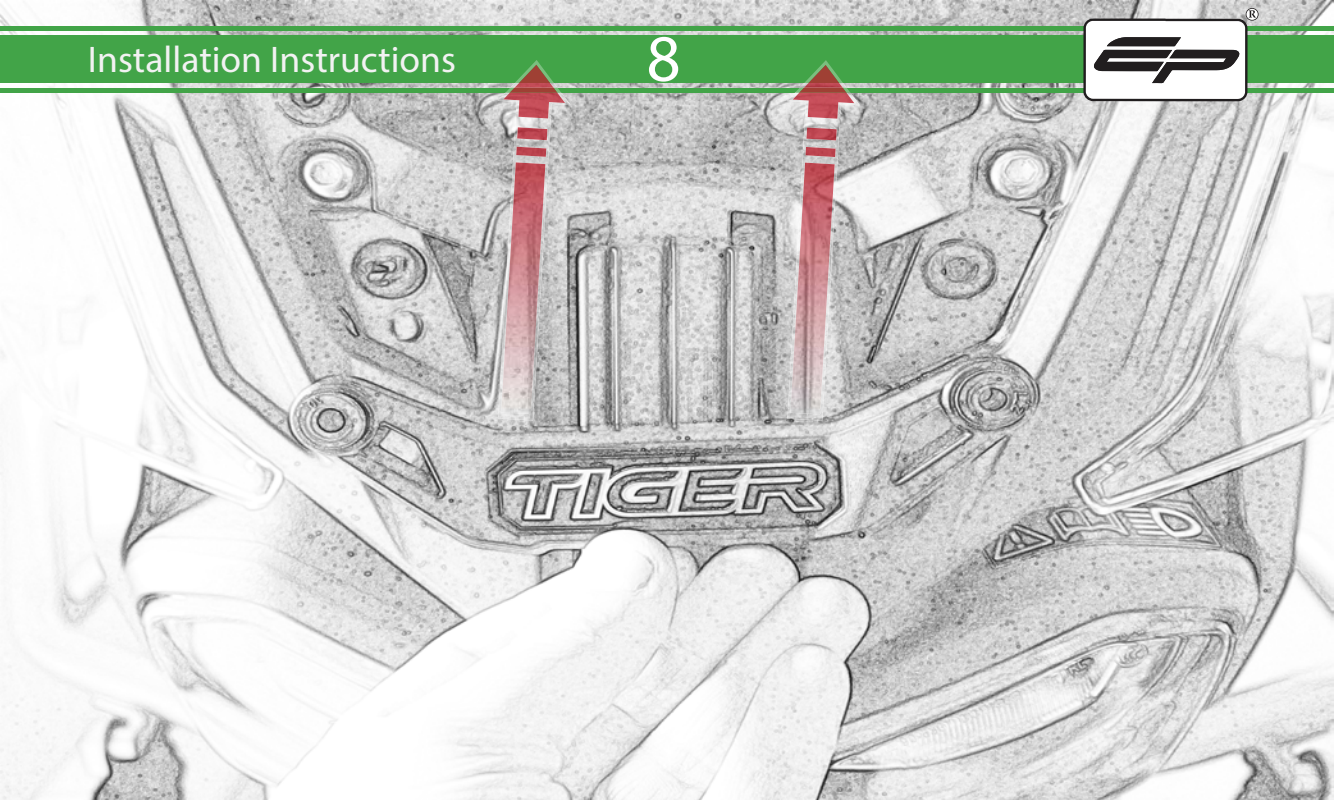



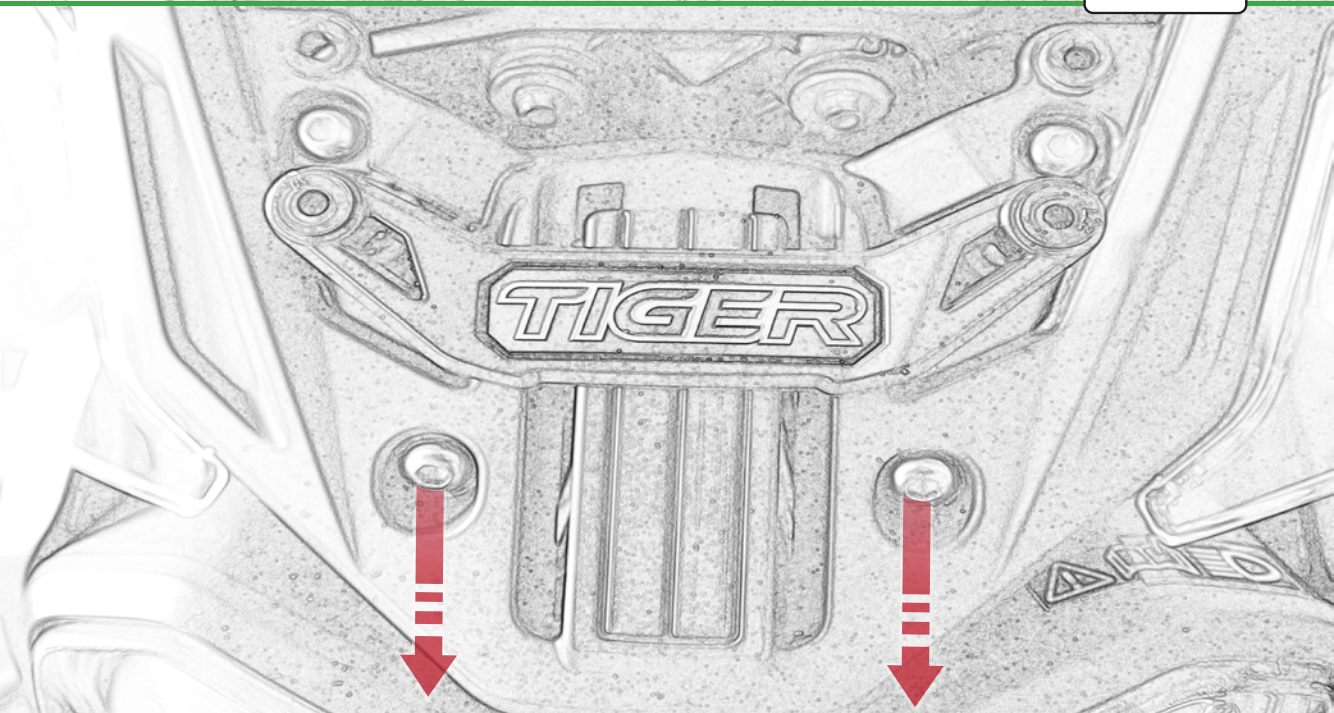

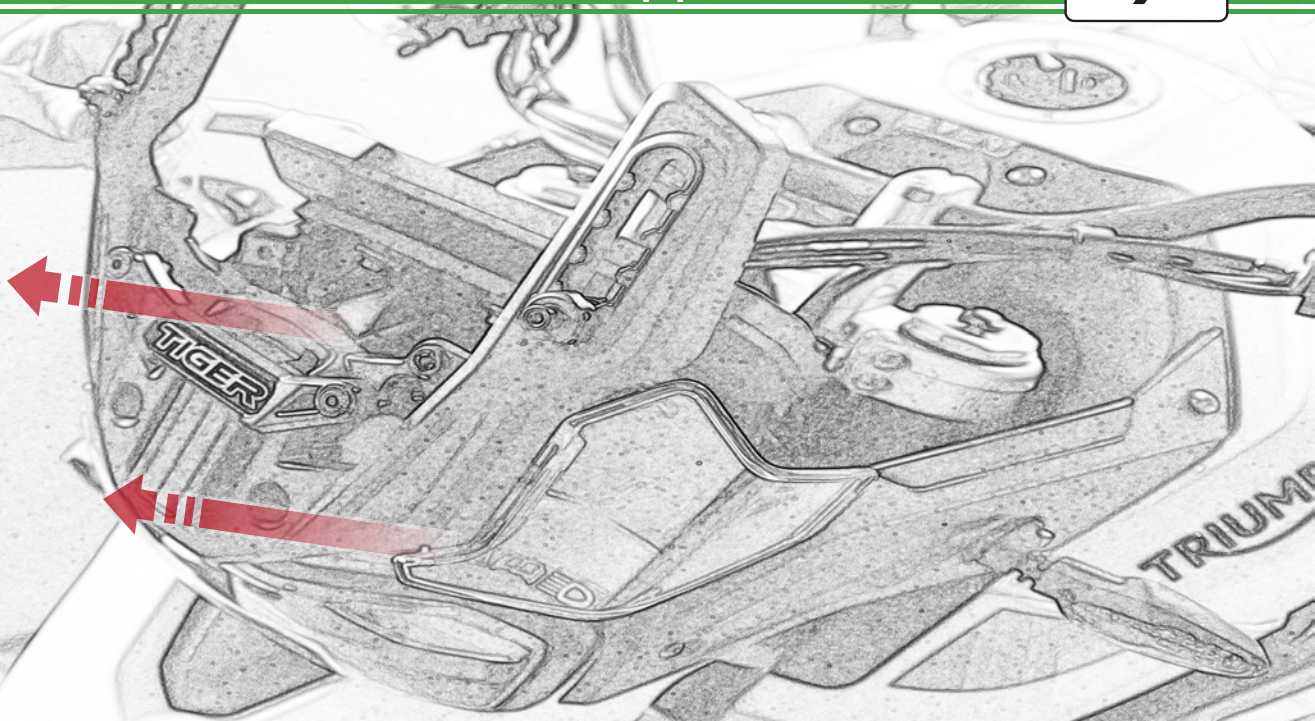

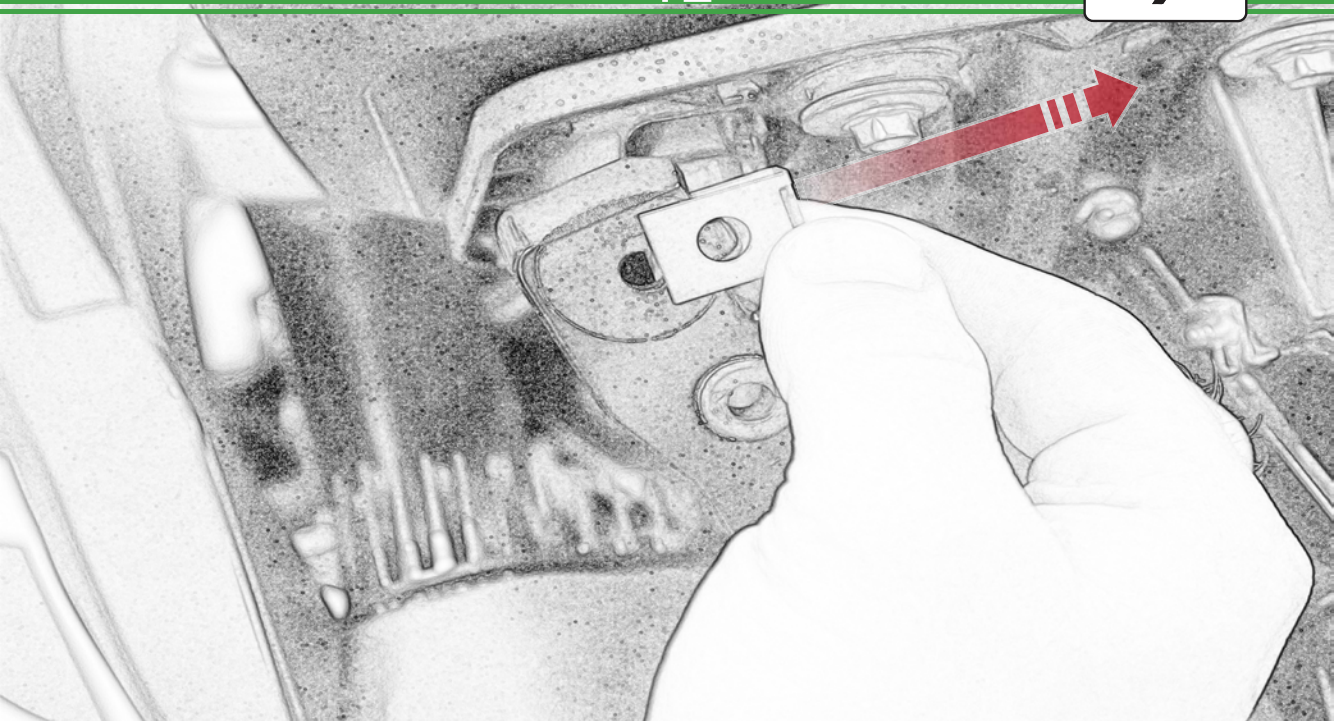

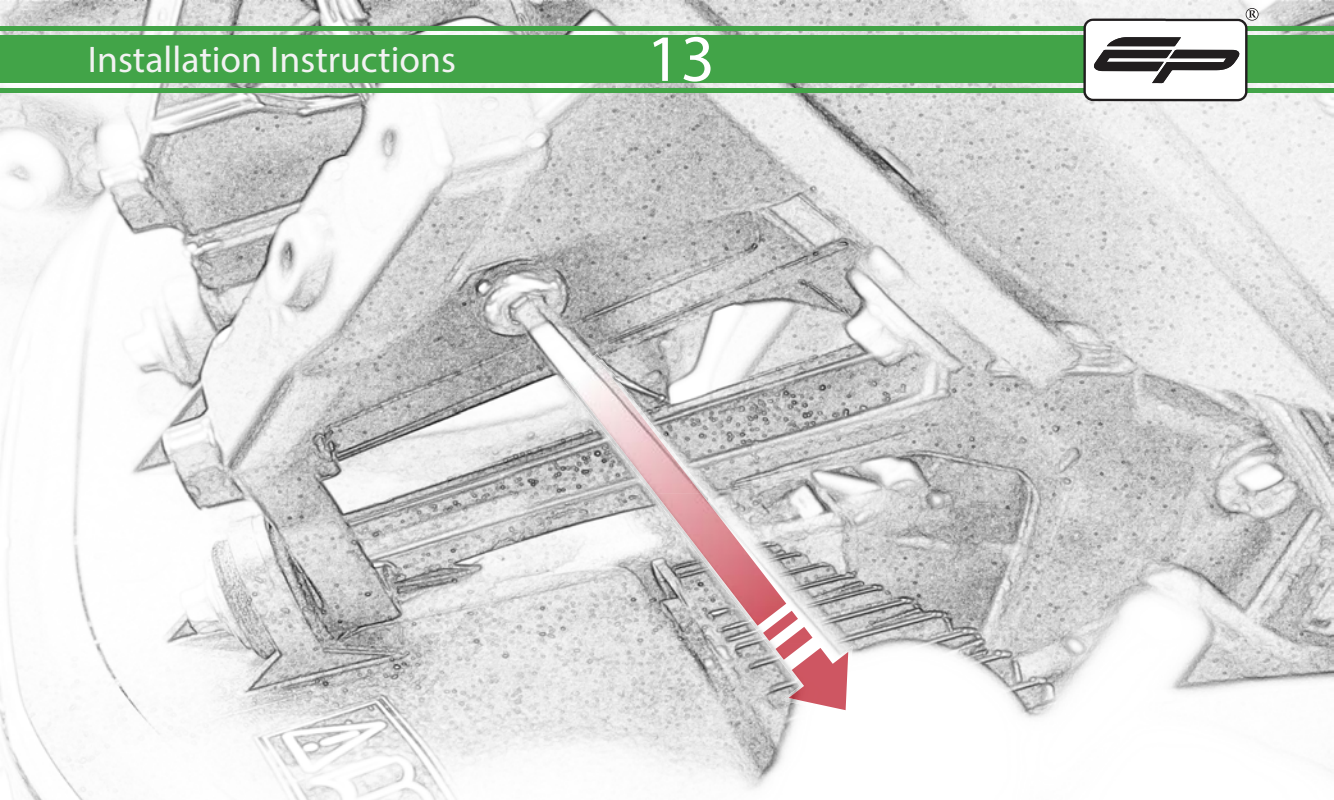

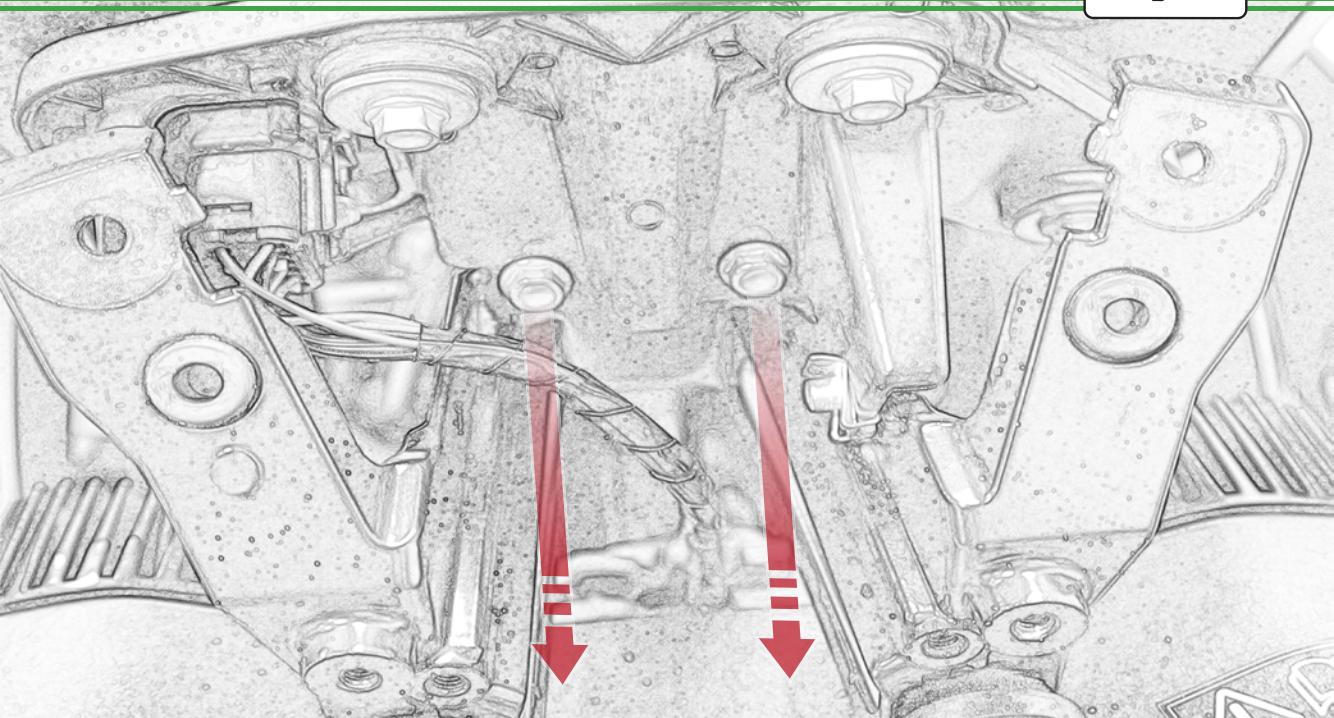

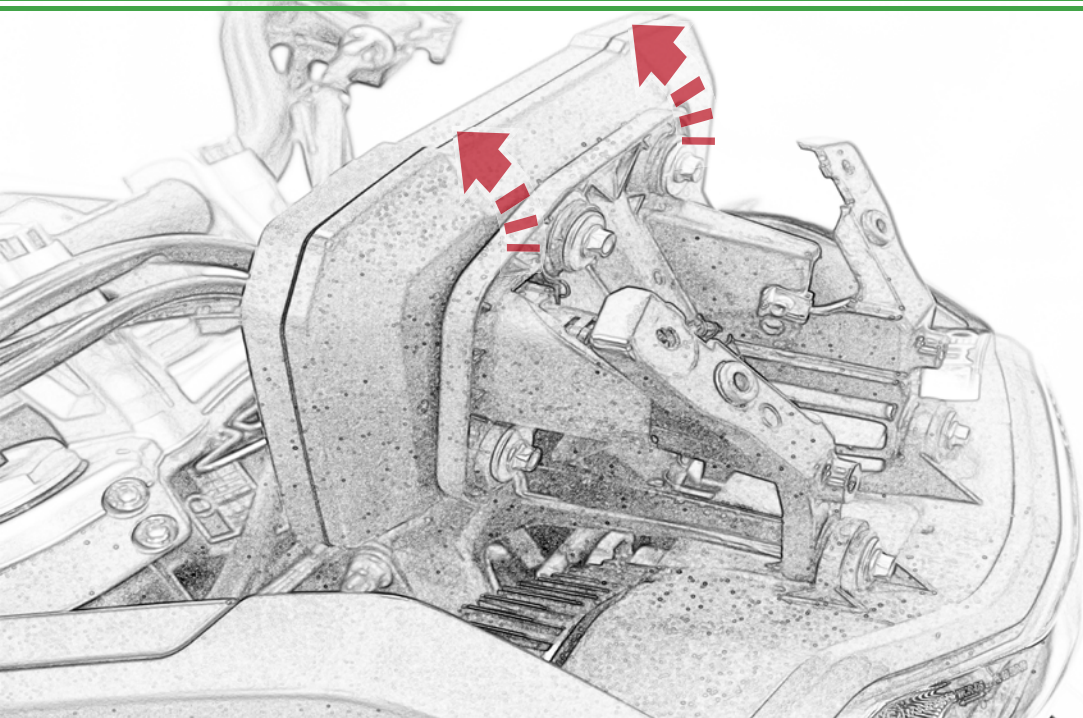

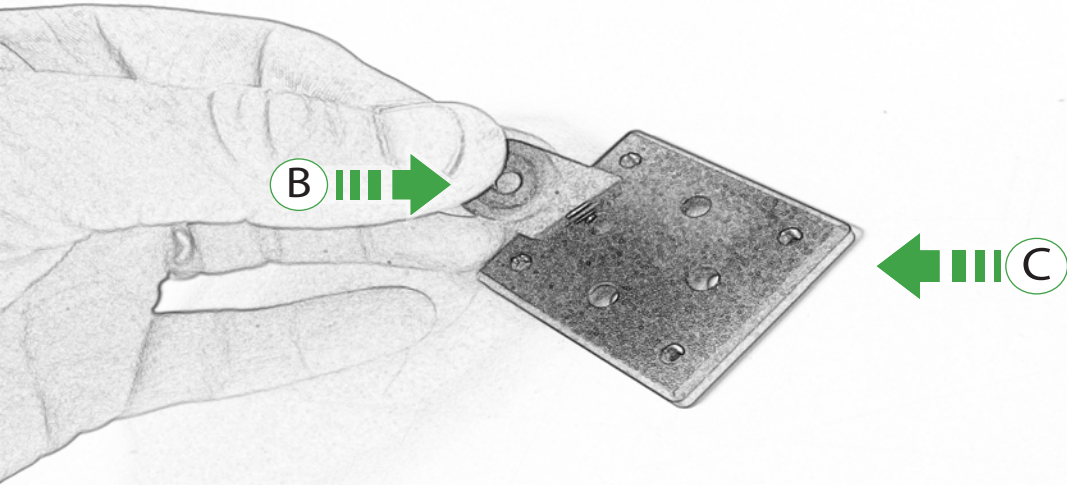

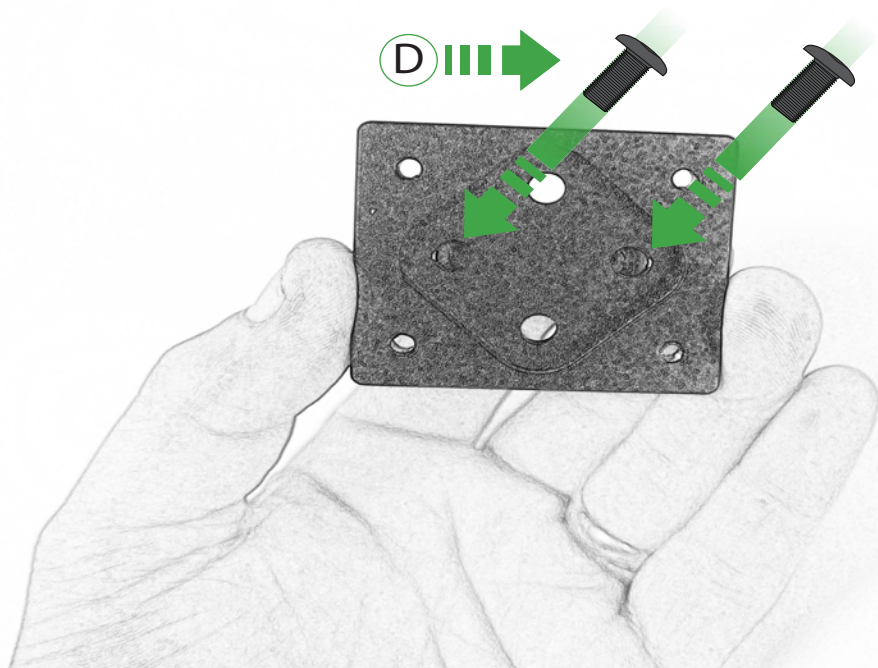

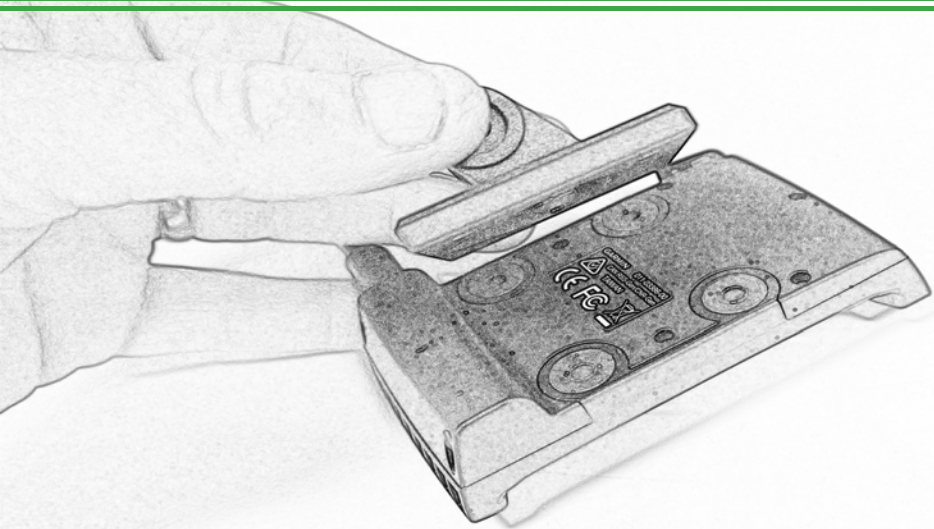

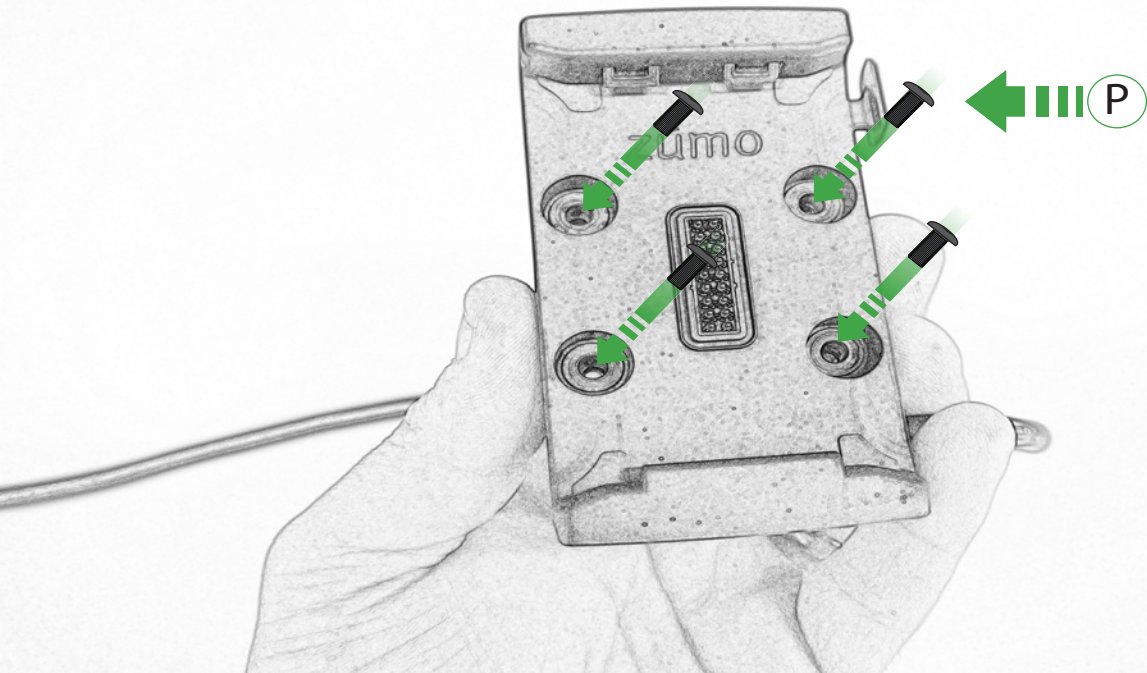

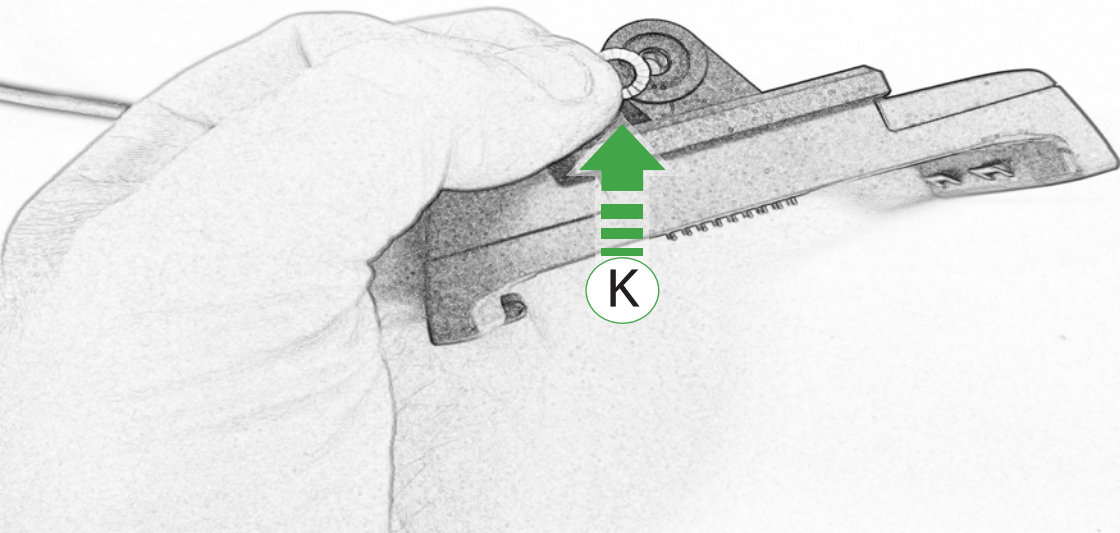

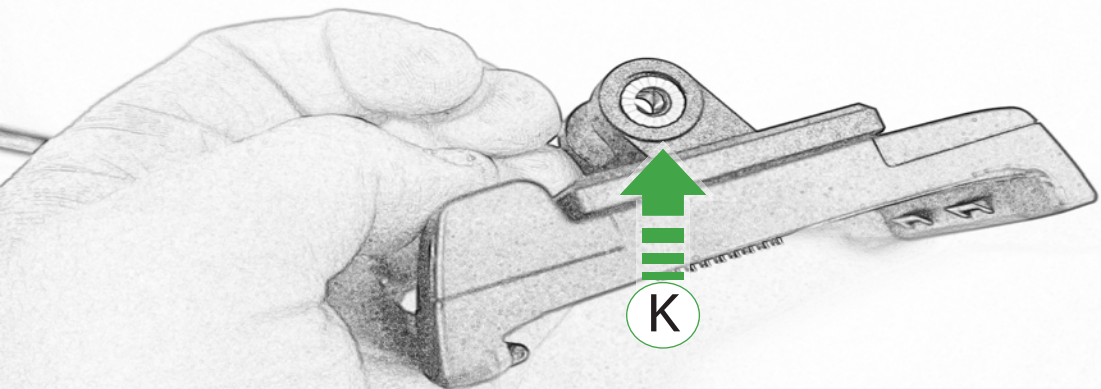

Repeat
Both Sides

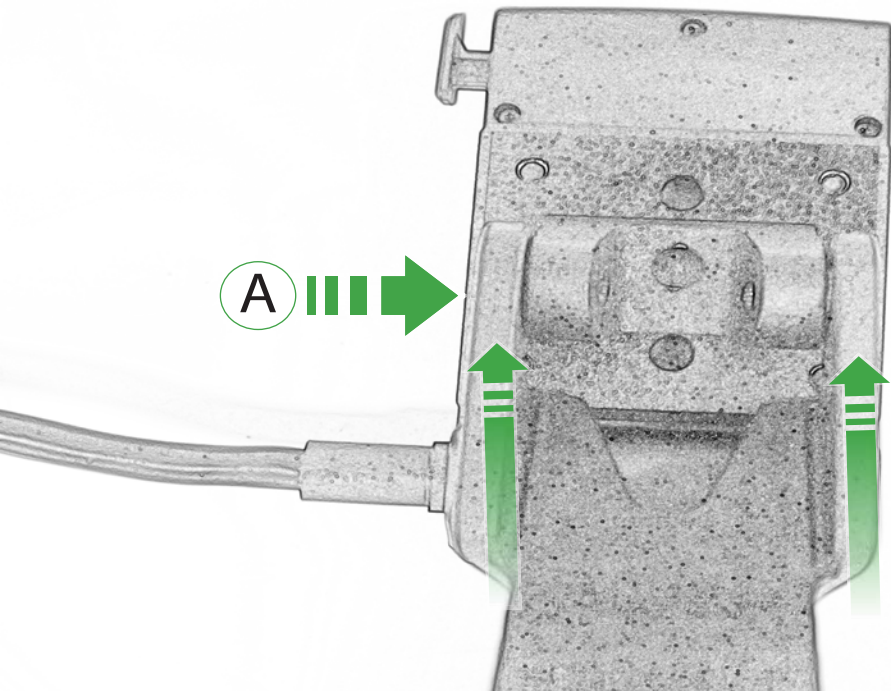

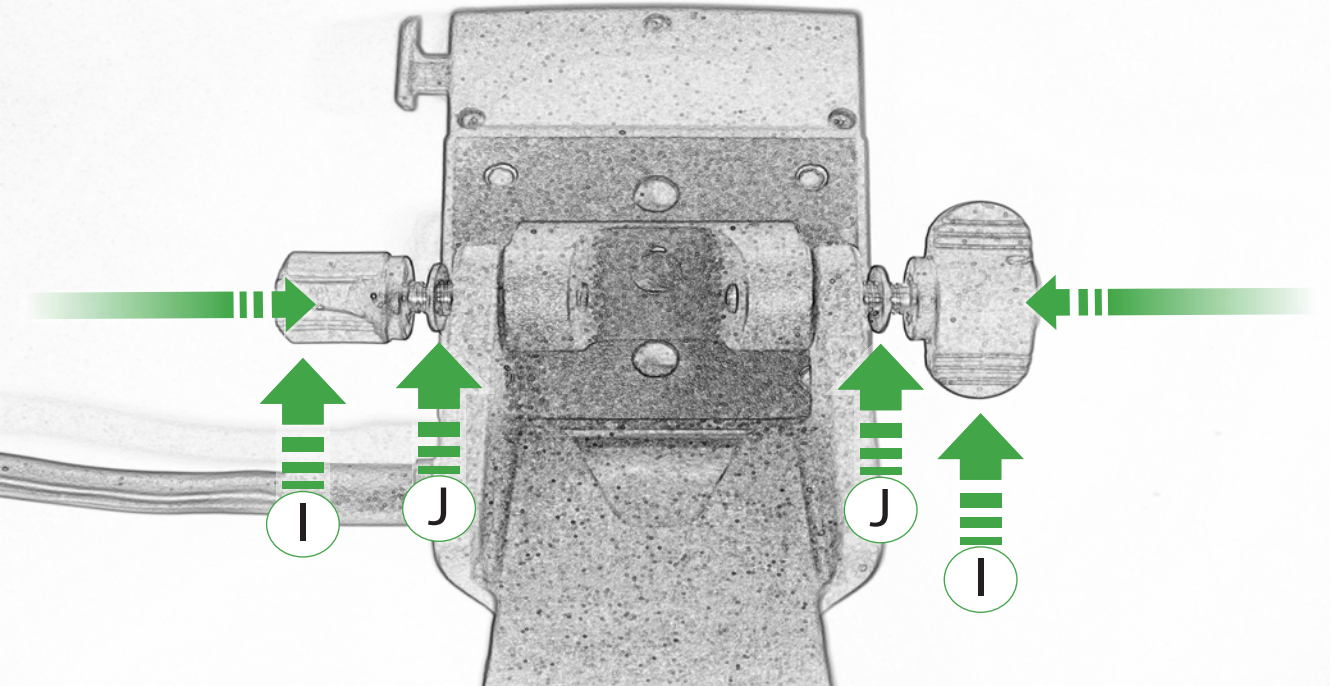

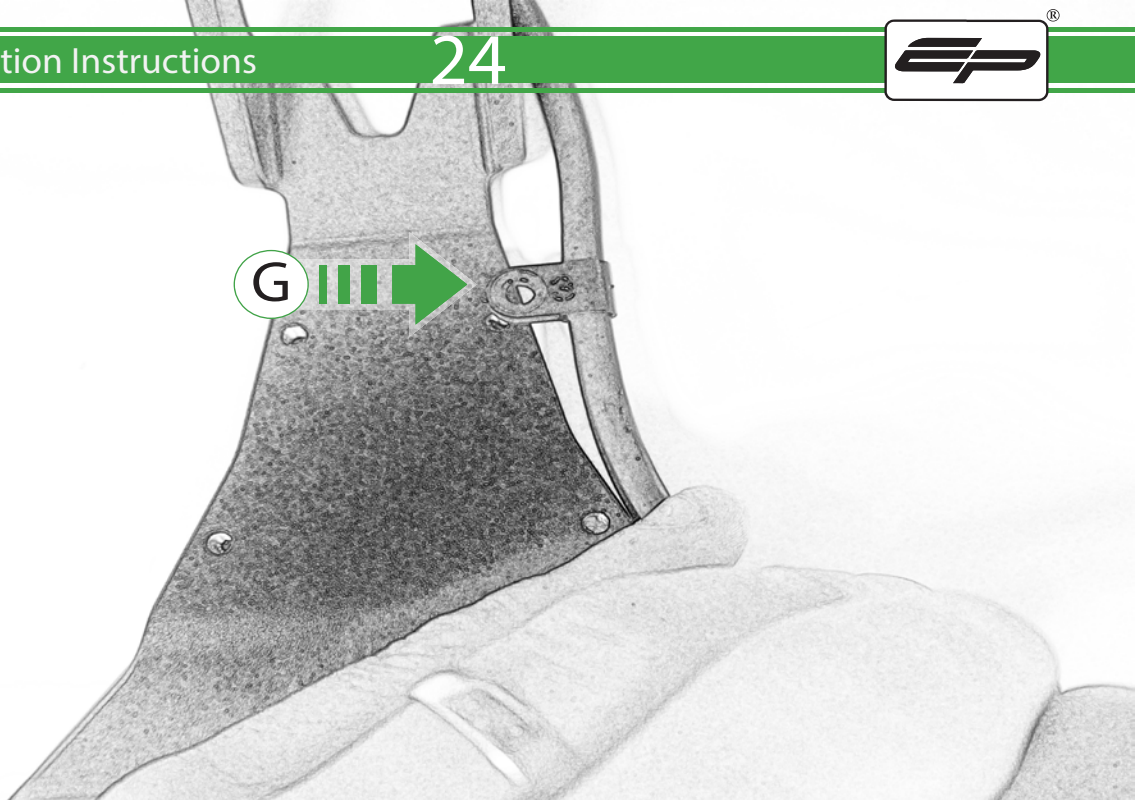

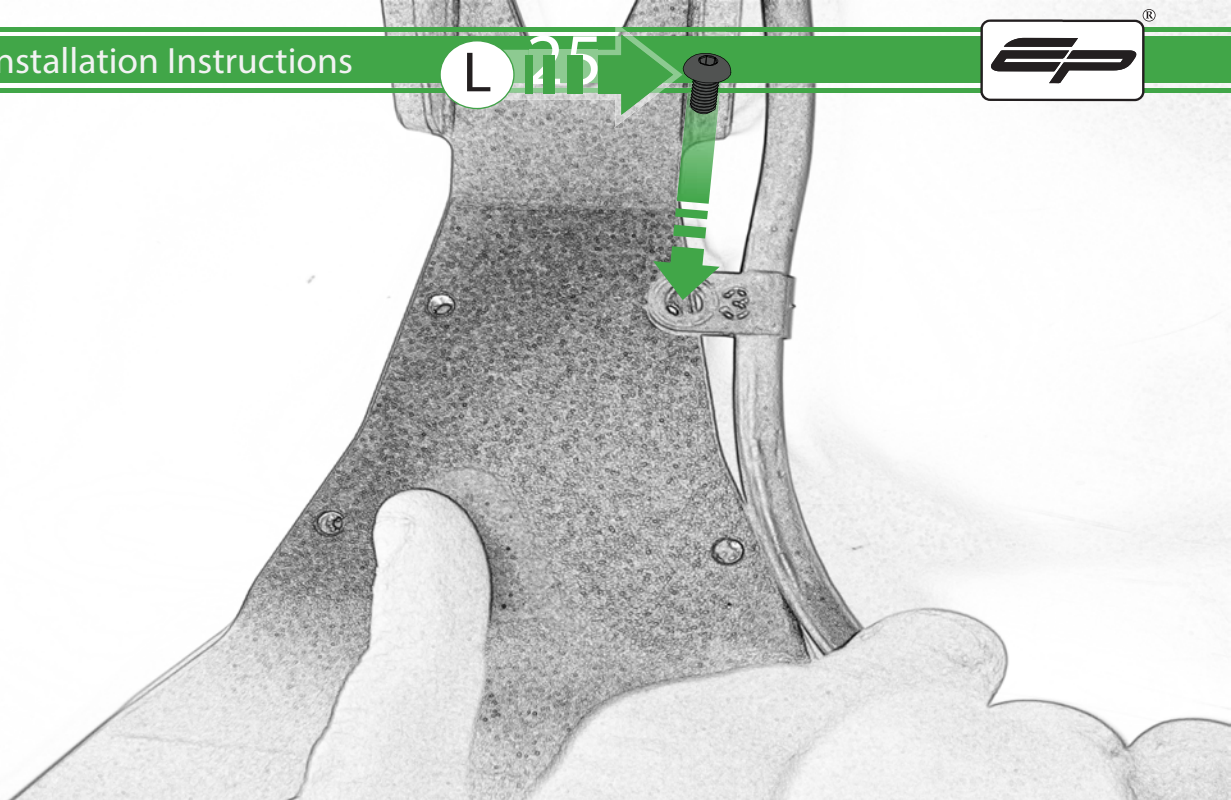

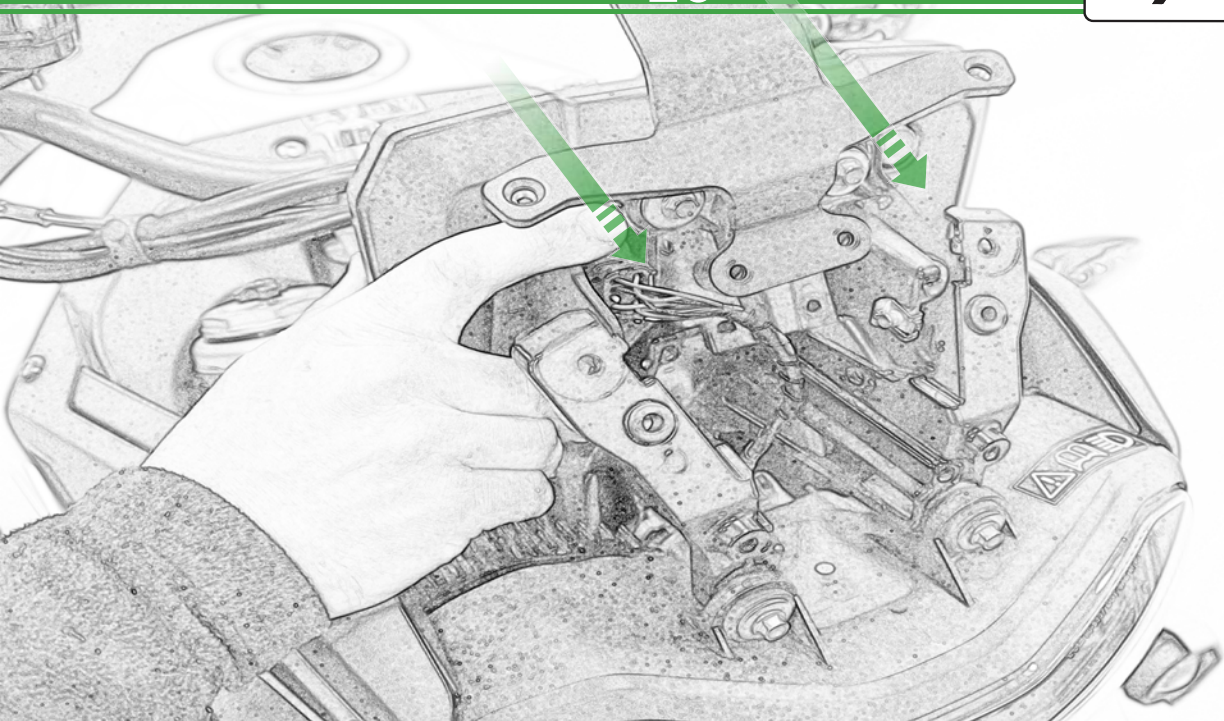

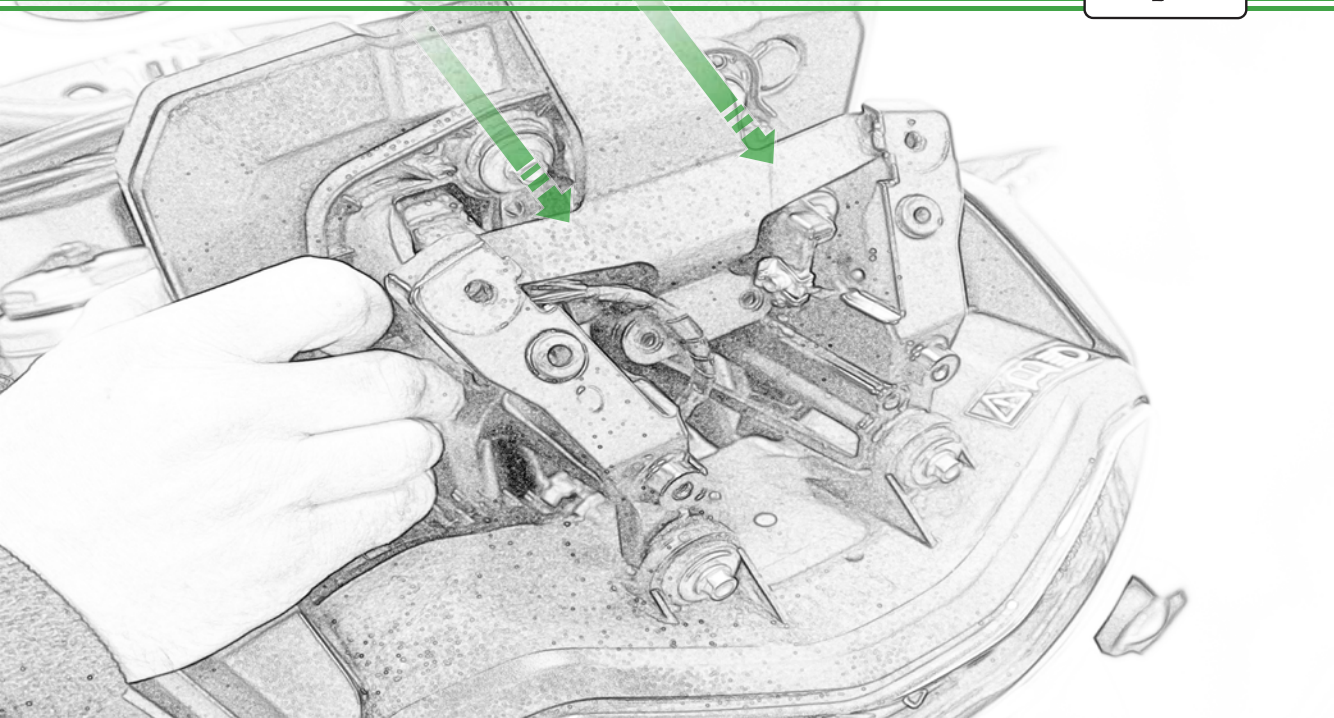

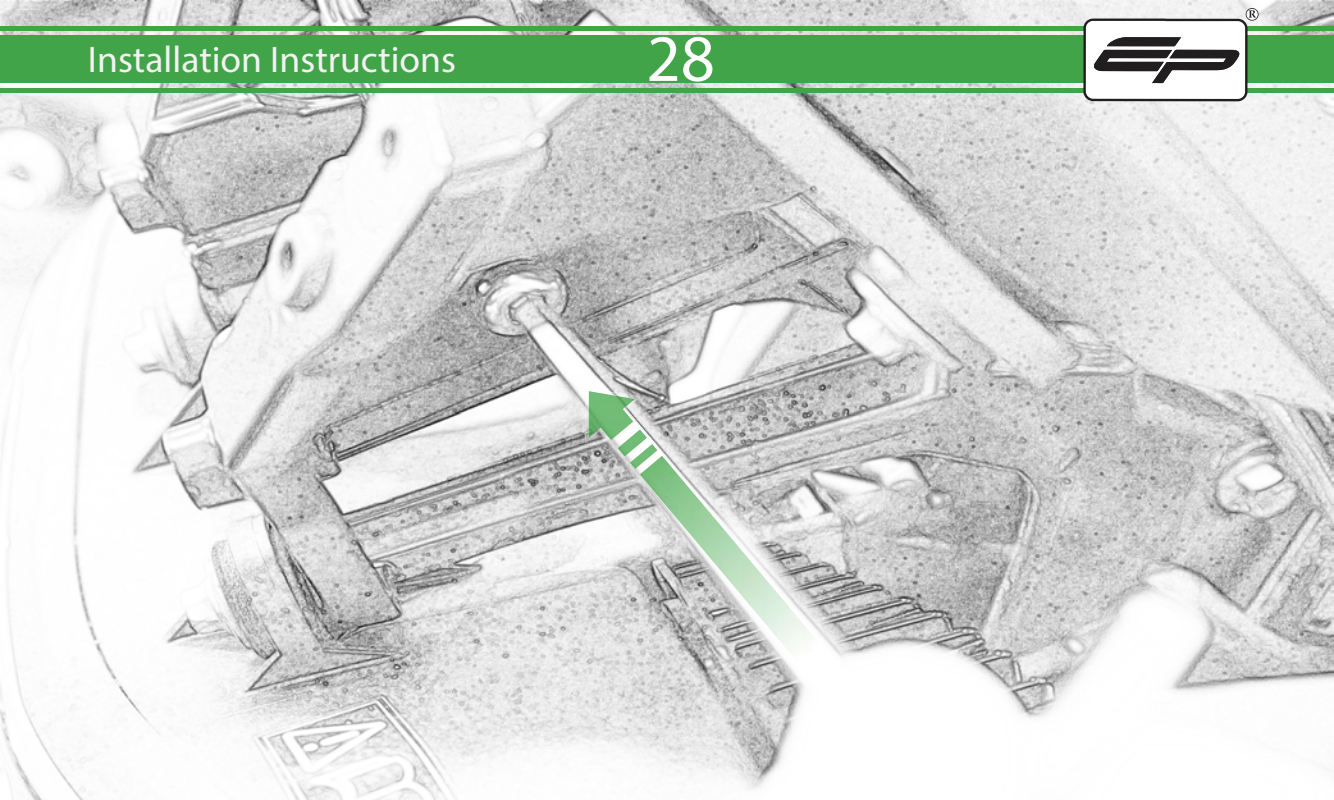

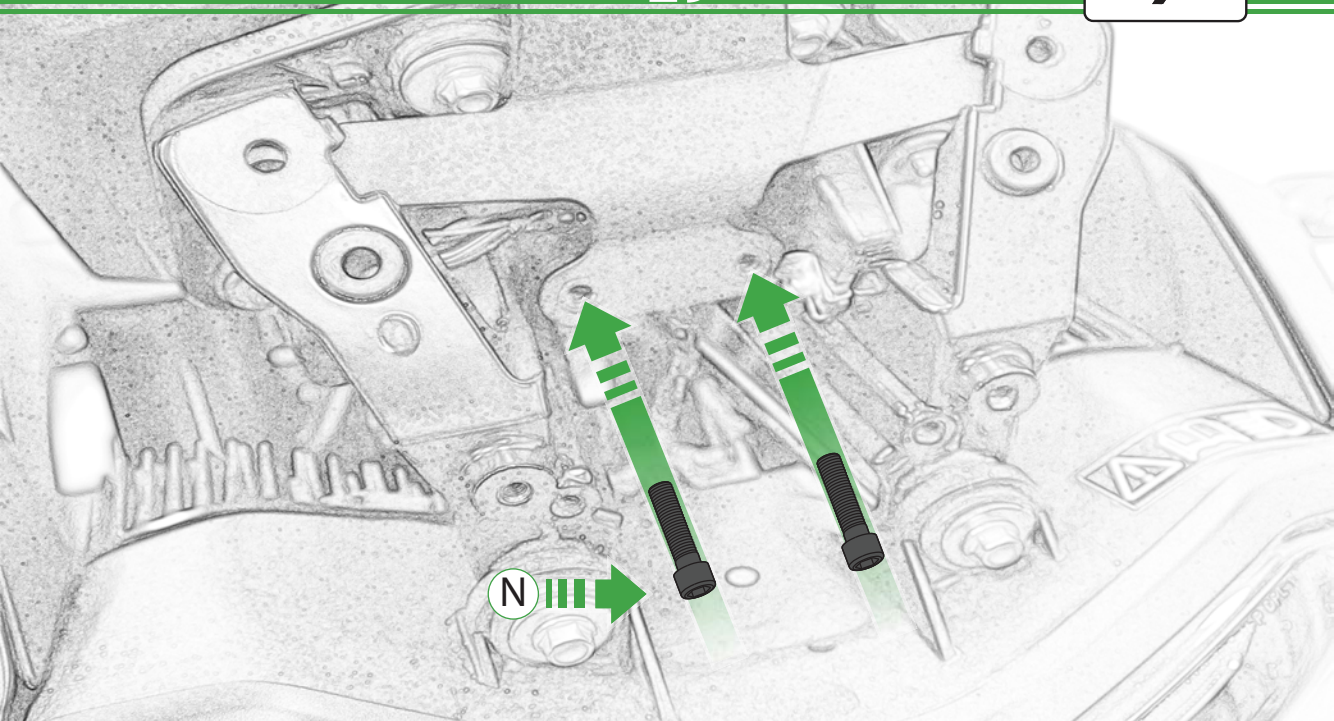

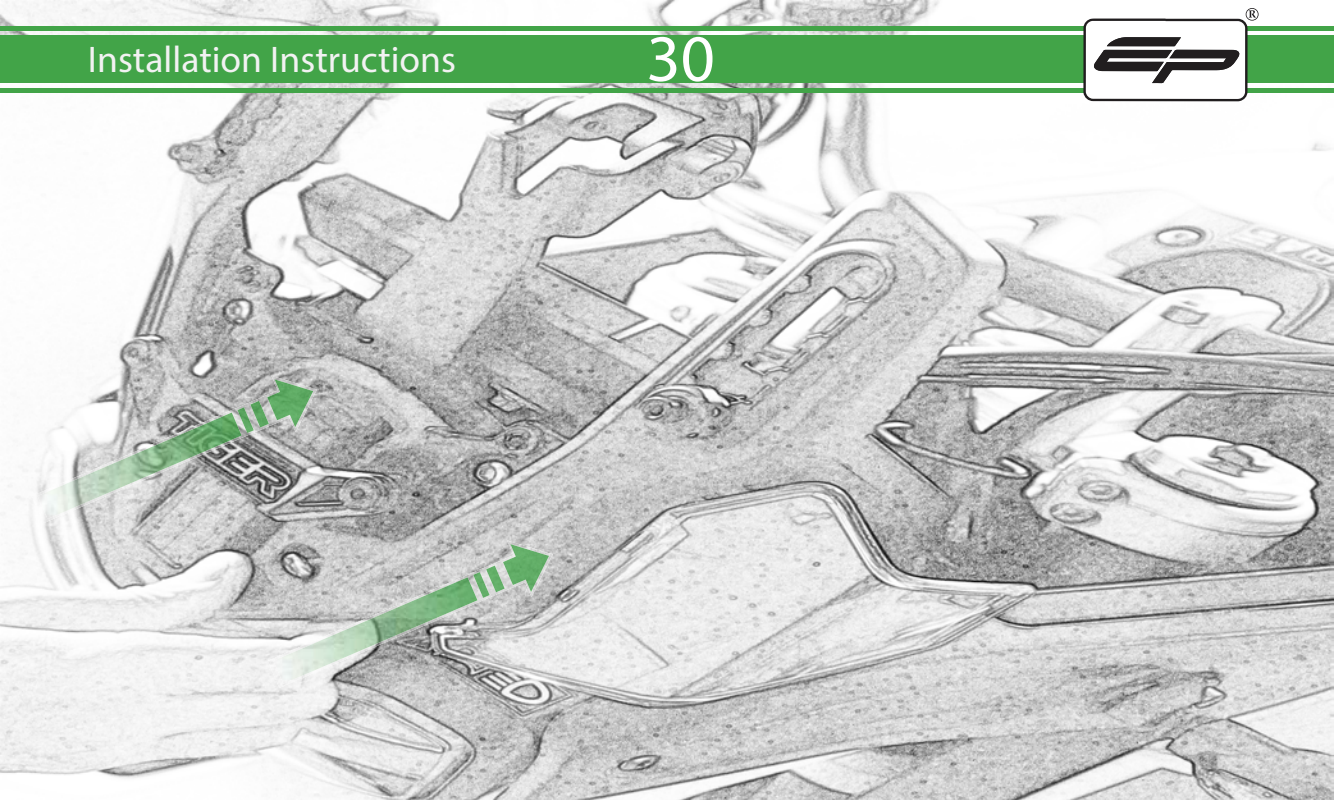

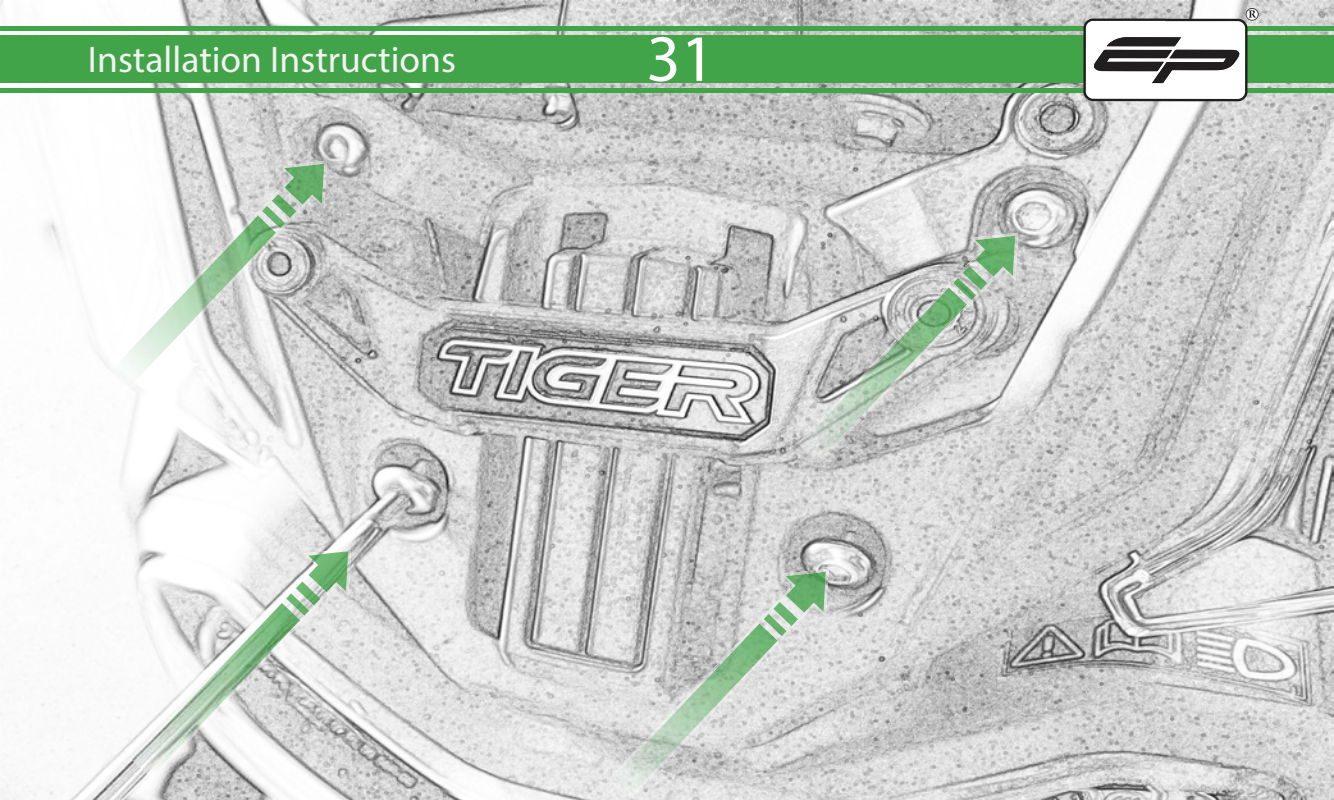

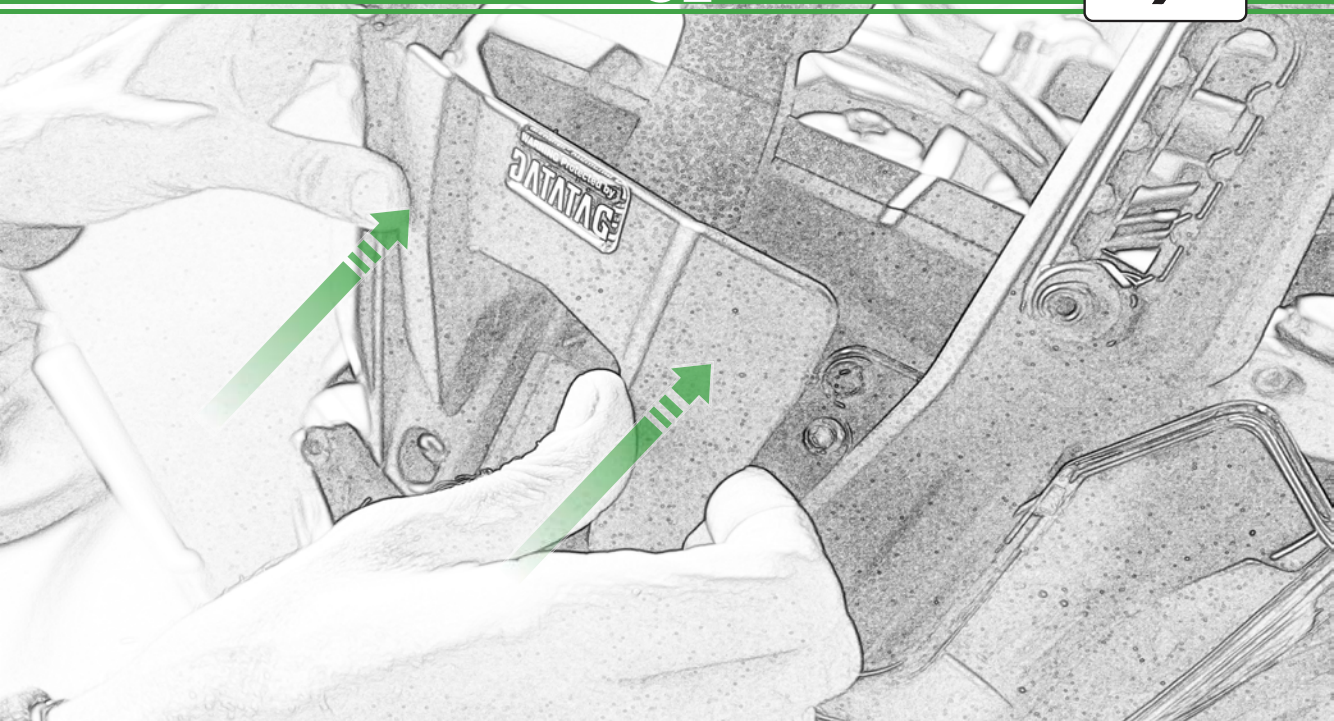

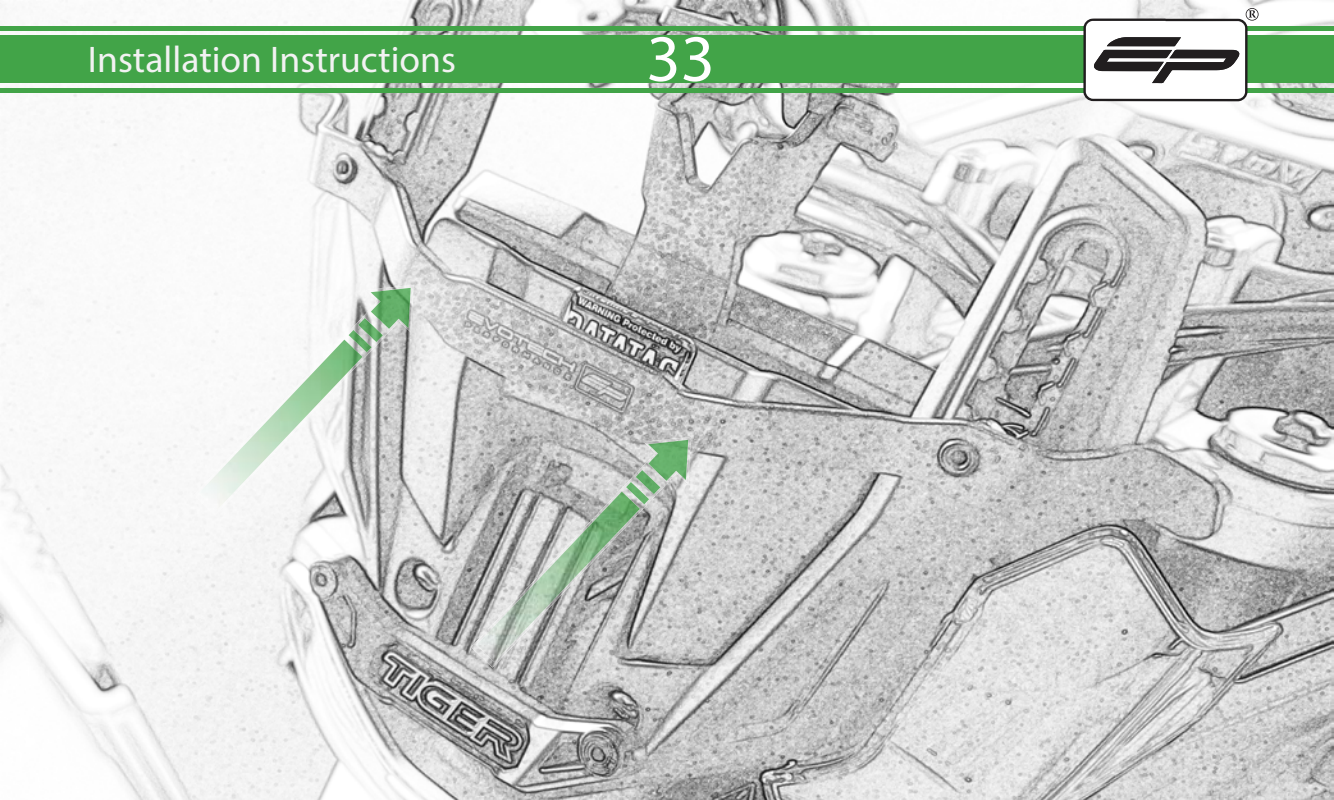

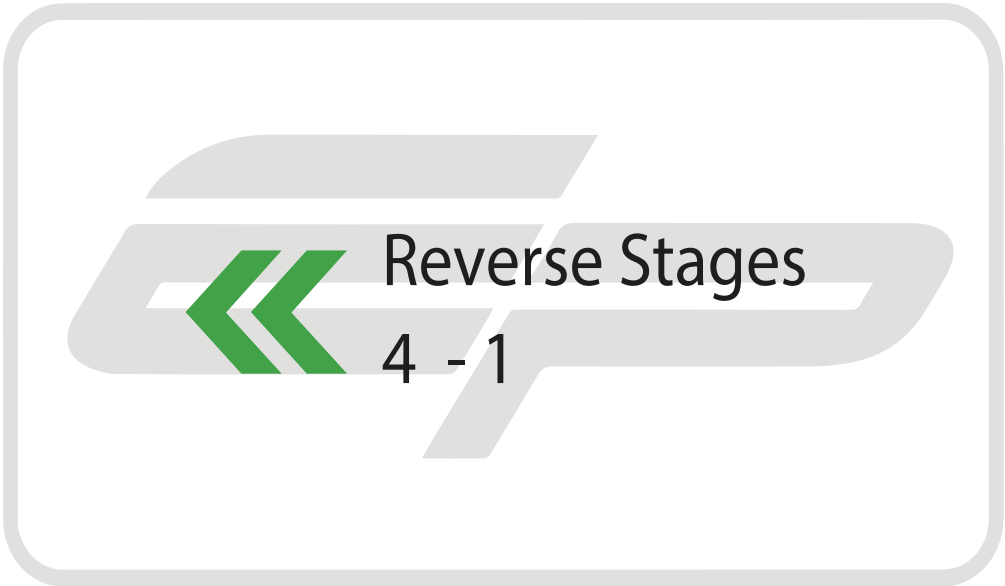



EVOTECH®
P E R F O R M A N C E

www.evotech-performance.com