



Lexan® Hardcoated Polycarbonate
 VStream® Windscreen
 N20054, Short Dark Tint
 N20055, Mid Size Light Tint
 N20056, Tall Clear
 for Honda® CB500F

Thank you for purchasing a National Cycle product. Read these instructions carefully and thoroughly before beginning work. Dealers, if installing this windscreen for a customer, please give them this manual. It contains information needed to properly maintain and use this product.



Attention:

Special notes and cautionary measures which can prevent damage to the accessory or motorcycle.



Note:

Tips for facilitation of operation, control and adjustment, as well as maintenance work.

CONTENTS OF KIT

Item	Description	Part No.	Qty.	Notes
1	VStream® Windscreen		1	
2	Bracket, Left		1	
3	Bracket, Right		1	
Bag#1130				
4	Grommet	44-447304-000	4	
5	Cap, Aluminum, Black	34-346037-000	4	
6	Screw, Flat, M6 x 12	51-514212-000	4	
7	Screw, Hex, M8 x 1.25	51-515749-000	4	
8	Washer, Flat	49-490317-000	4	

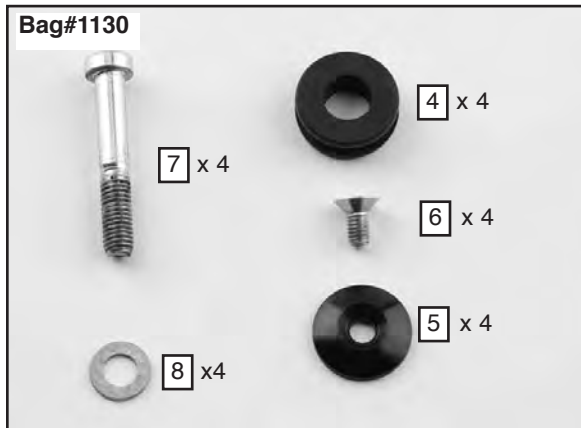
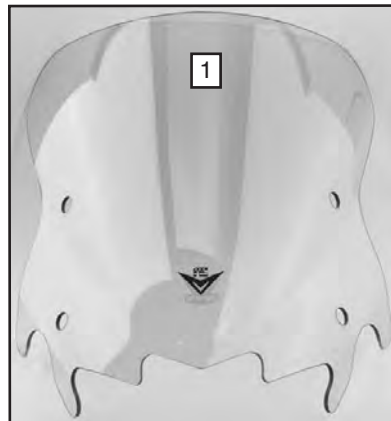
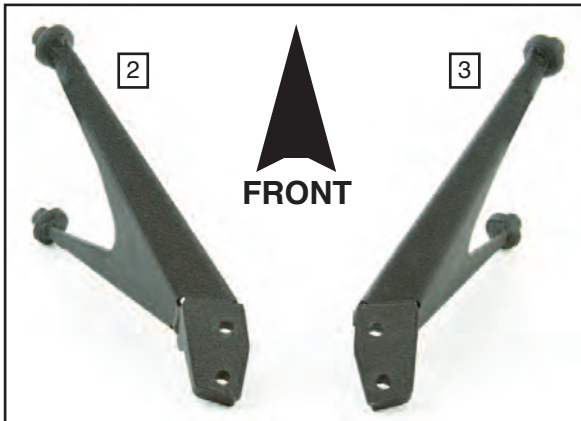

TOOLS

- 12mm Socket with Handle (removal of stock bolts)
- 5mm and 4mm Hex Wrench
- Torque Wrench
- Medium Strength Thread Lock (Loctite® 243)

National Cycle, Inc. PO Box 158 Maywood, IL 60153-0158 USA

708-343-0400 / Fax: 708-343-0625 / www.nationalcycle.com / e-mail: info@nationalcycle.com

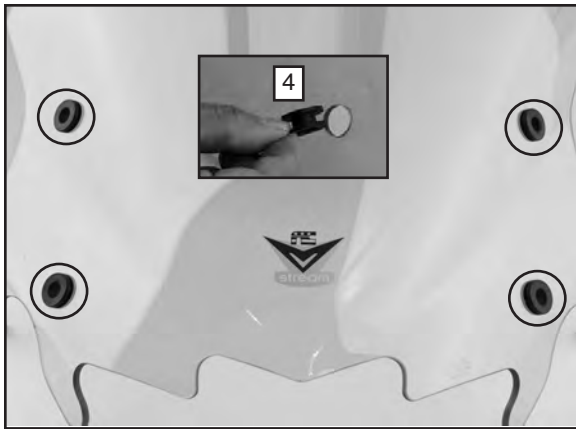

Figure 1



Figure 2

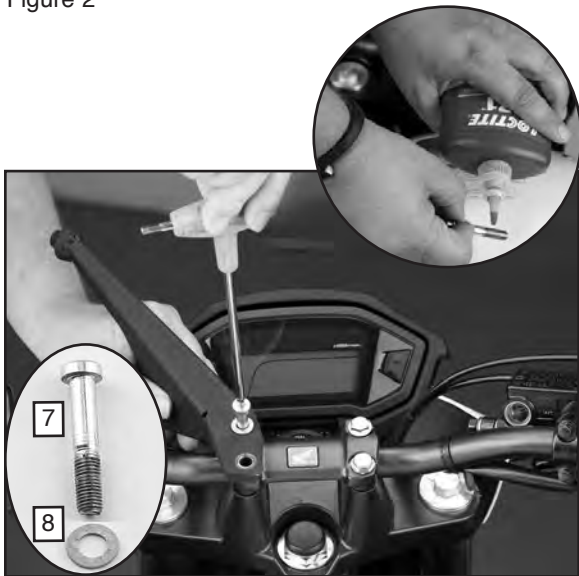

Figure 3

PREPARATION

1. Position motorcycle securely on its side stand.

INSTALLATION

1. Install one Grommet (4) into each hole on windshield. **Figure 1.**



Install Left Bracket

Work on one side of the bar clamp at a time.

2. Remove the stock handlebar clamp bolts from the LEFT side. **(12mm Socket) Figure 2**



Stock hardware will not be re-used.

3. Apply a small amount of thread locker on a M8 Screw (7). **(Thread Lock) Figure 3**

4. Use a Washer (8) and M8 Screw (7) to install Bracket (2) onto handlebar clamp. Repeat procedure at lower hole. **(5mm Hex Wrench) Figure 3**



Figure 4

Install Right Bracket

5. Remove the stock handlebar clamp bolts from the RIGHT side. (12mm Socket) **Figure 4**

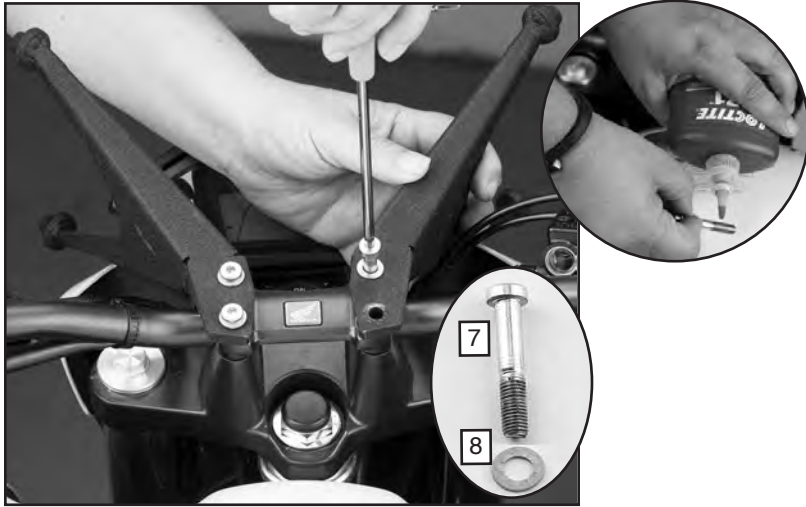

Figure 5

6. Apply a small amount of thread locker on a M8 Screw (7). (Thread Lock) **Figure 5**

7. Use a Washer (8) and M8 Screw (7) to install Bracket (3) onto handlebar clamp. Repeat procedure at lower hole. (5mm Hex Wrench) **Figure 5**

8. Torque the four M8 Screws (7) to 18 ft-lbs (24 Nm) (Torque Wrench and 5mm Hex) **Figure 6**



Figure 6

9. Use one M6 Flat Screw (6) and Cap (5) to attach windscreen to mounts. Repeat procedure at all 4 holes. Tighten screws firmly. **Figure 7.** (4mm Hex Key)

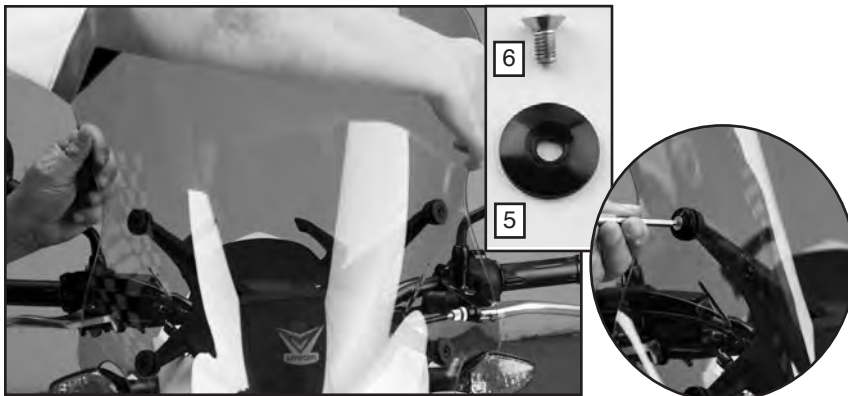

Figure 7



Ask for Shield Wash™ and RainZip® at your local dealer or visit www.nationalcycle.com.

CLEANING AND MAINTENANCE

To clean the screen, wash with a clean soft cloth, plenty of warm water and if necessary, a non-abrasive soap such as dishwashing liquid. Flannel or soft chamois make good cleaning cloths. **Paint, glue residue or grease removal:** Moisten cotton with naphtha or turpentine followed by a wash as above. National Cycle **Shield Wash™** (N1401-01) makes a good daily cleaner and comes with a handy travel size bottle. Shield Wash is safe for all windshields and helmet visors.

Do not clean polycarbonate in hot sun or high temperatures. Do not clean the screen with glass cleaners.

Do not allow brake fluid, alcohol, or strong solvents to contact the screen.

RAIN REPELLENT

Do not use rain protective products made for glass. We recommend National Cycle's **RainZip®** (N1410-01) to keep your windshield clear in rainy weather.



Register your windshield online at www.nationalcycle.com

National Cycle 3-Year Limited Warranty

National Cycle hereby warrants to the original registered owner of a National Cycle polycarbonate windshield for a period of three years from the date of purchase against breakage. This limited warranty is expressly limited to the replacement of the polycarbonate windshield. This limited warranty does not include scratches, coating failure, cosmetic wear and tear, replacement of hardware, or any consequential damages or expenses including labor cost of installation, removal and/or replacement, inconvenience, inbound freight expenses or damage to any other component of the motorcycle or any other accessories. Certain chemicals, generally known as acidic hydrocarbons, are known to cause polycarbonate damage and will not be covered under this limited warranty. Please refer to the cleaning instructions supplied with all National Cycle windshields.

Visit www.nationalcycle.com for further details, or call or write National Cycle

! WARNING

Never ride your motorcycle with loose accessory mounting hardware. Check the hardware for tightness regularly.

Today's motorcycles are built with enough frame rigidity to withstand the moderate loads imposed on them by the foreseeable addition of an accessory(ies). If an accessory(ies) adversely affects your motorcycle's stability, immediately remove the accessory(ies). Do not ride a motorcycle that exhibits unsafe handling traits.

Have experienced service personnel correct any problem before riding with the accessory(ies) installed. For further questions concerning handling problems associated with an accessory(ies), contact your dealer, motorcycle manufacturer, or accessory manufacturer.

Sunlight reflected off the inside curvature of the windshield can, at certain times of day, cause extreme heat buildup on the motorcycle instruments and possibly even melt them. Exercise care in parking to avoid this. Park your motorcycle facing the sun or place an opaque object over this area.

VStream® windshield patent no. 7,387,328

National Cycle, Inc. PO Box 158 Maywood, IL 60153-0158 USA

708-343-0400 / Fax: 708-343-0625 / www.nationalcycle.com / e-mail: info@nationalcycle.com