



EVOTECH®
P E R F O R M A N C E

Installation Instructions



YAMAHA MT-09 2013 PILLION FOOTREST REMOVAL KIT

Product Reference - 11284

Kit Contents

- Ⓐ 1 x RH Blanking Plate
- Ⓑ 1 x LH Blanking Plate
- Ⓒ 4 x M8 x 16 Black Socket Button Head Screws

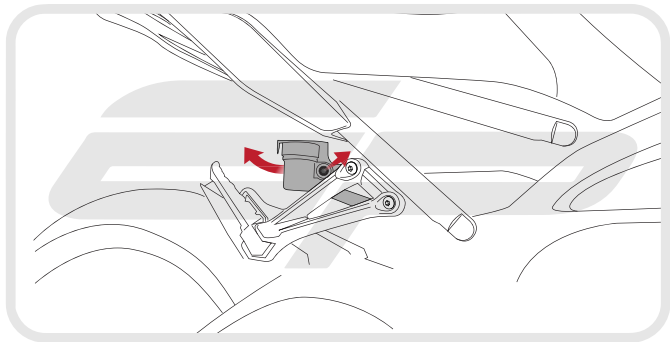

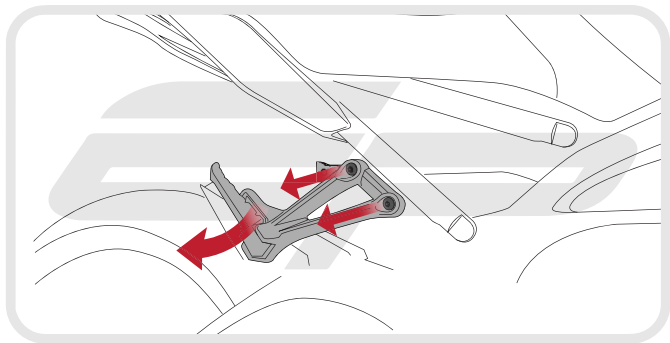

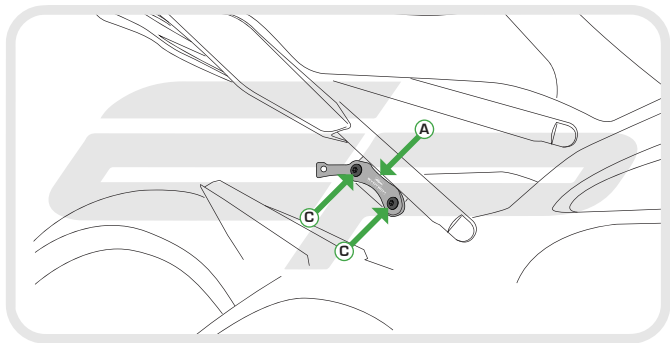

EVOTECH[®]
P E R F O R M A N C E

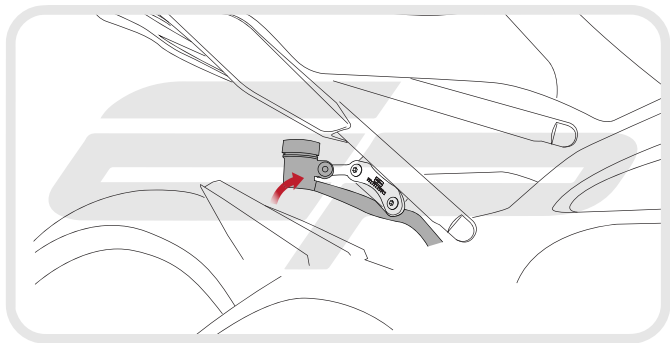

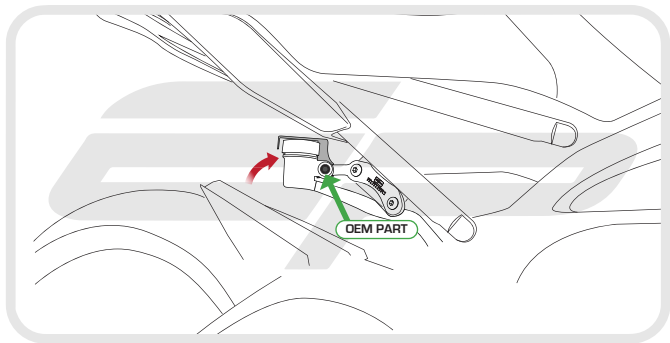

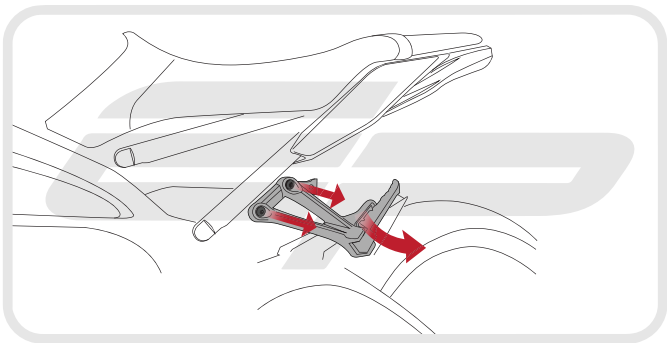

EVOTECH[®]
P E R F O R M A N C E

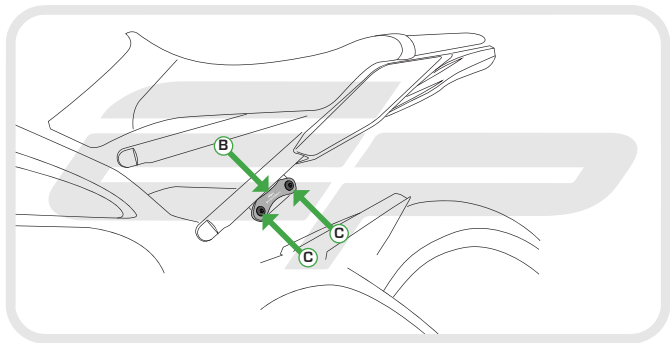



EVOTECH®
P E R F O R M A N C E

www.evotech-performance.com