



**EVOTECH**®  
P E R F O R M A N C E

**Yamaha MT-09**

**Tail Tidy**

**Installation Instructions**



## Kit Contents PRN013753

- |                                    |                                       |
|------------------------------------|---------------------------------------|
| <b>A</b> 1 x Main Bracket          | <b>M</b> 2 x M5 x 20 Button Head Bolt |
| <b>B</b> 1 x Lower Bracket         | <b>N</b> 2 x O-Rings                  |
| <b>C</b> 1 x Main Tail Tidy        | <b>O</b> 2 x Vinyl Caps               |
| <b>D</b> 1 x Upper Tail Tidy       | <b>P</b> 2 x Indicator Retainer       |
| <b>E</b> 1 x Axle Block R/H        | <b>Q</b> 2 x Indicator Extensions     |
| <b>F</b> 1 x Axle Block L/H        | <b>R</b> 4 x M6 x 16 Button Head Bolt |
| <b>G</b> 1 x Reflector Kit         | <b>S</b> 6 x M4 x 8 Button Head Bolt  |
| <b>H</b> 1 x Retro Light           |                                       |
| <b>I</b> 1 x Rear Light Connector  |                                       |
| <b>J</b> 1 x Light Mount           |                                       |
| <b>K</b> 2 x Indicator Mount Upper |                                       |
| <b>L</b> 2 x Indicator Mount Lower |                                       |

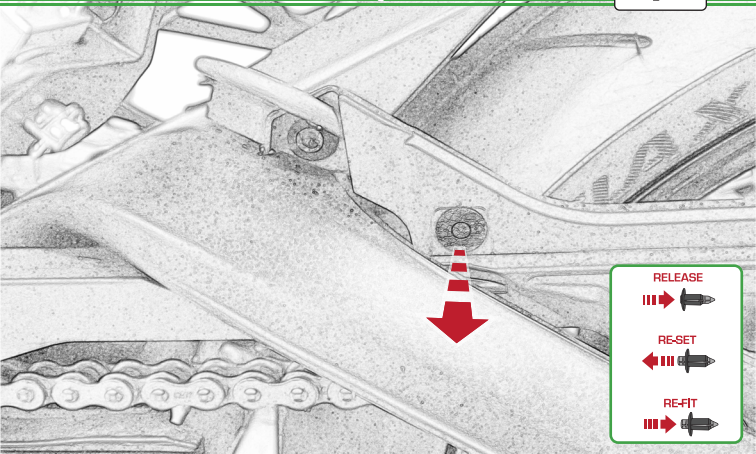

**RELEASE**

**RE-SET**

**RE-FIT**

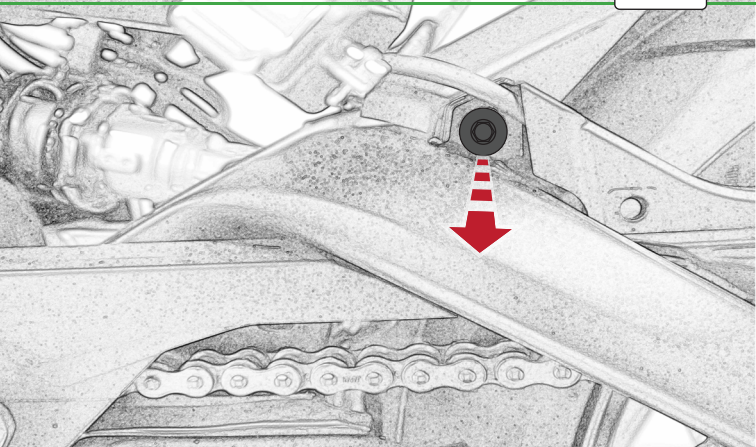

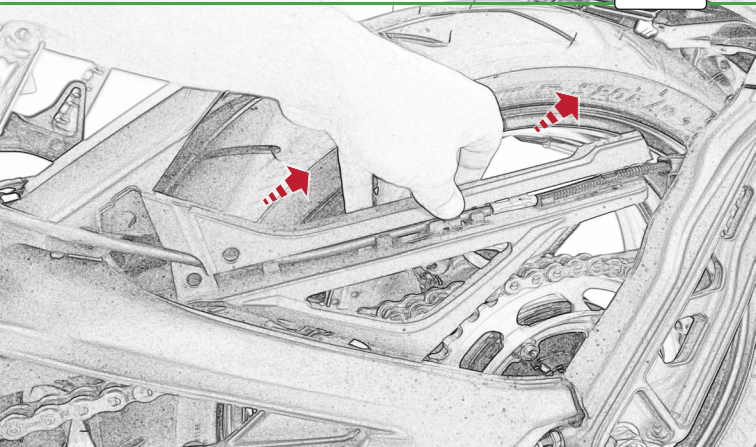

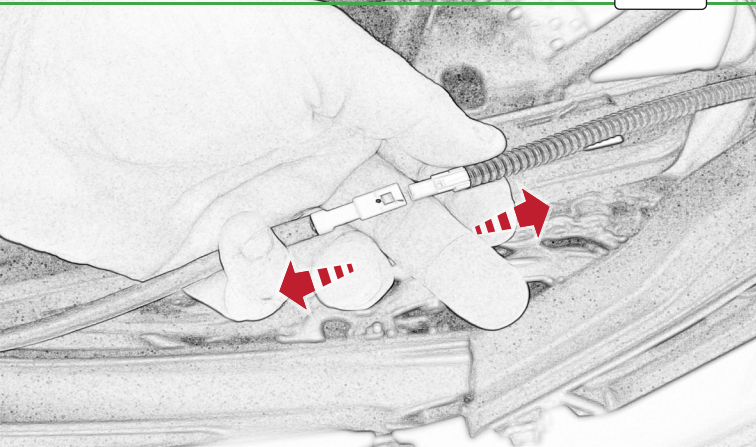



Reverse Stages

3 - 1

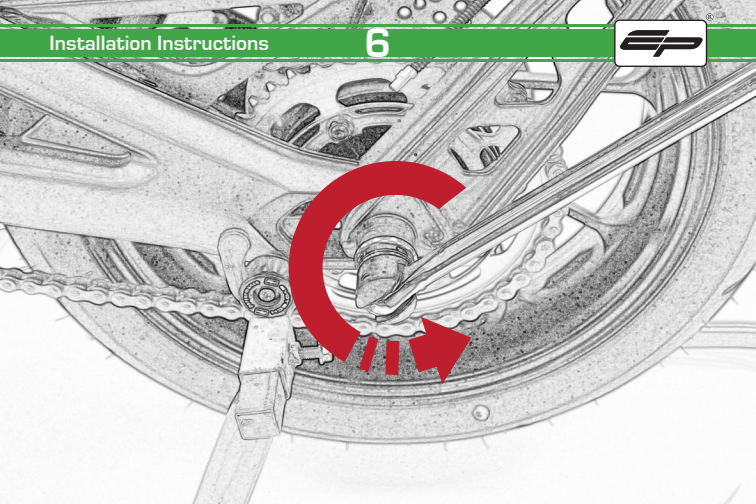



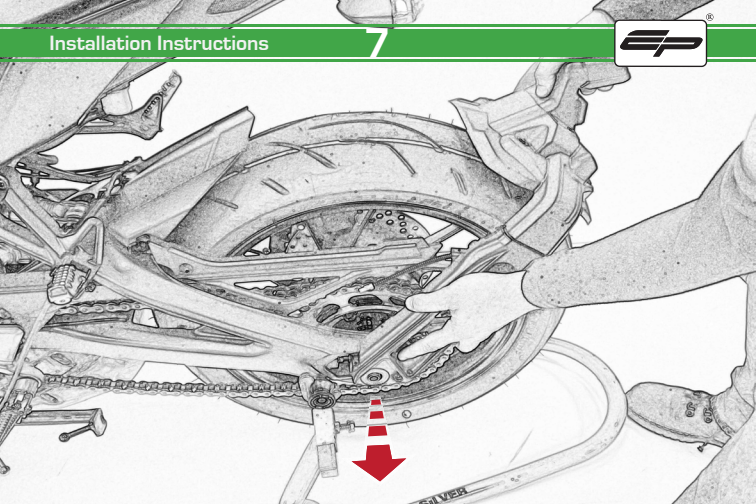

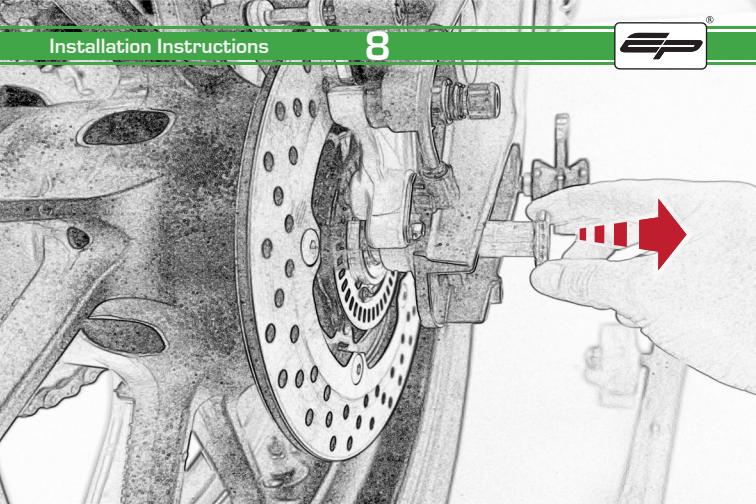

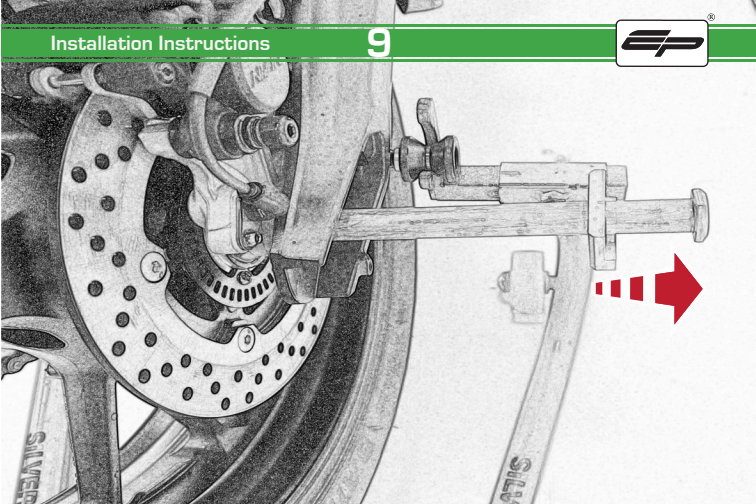

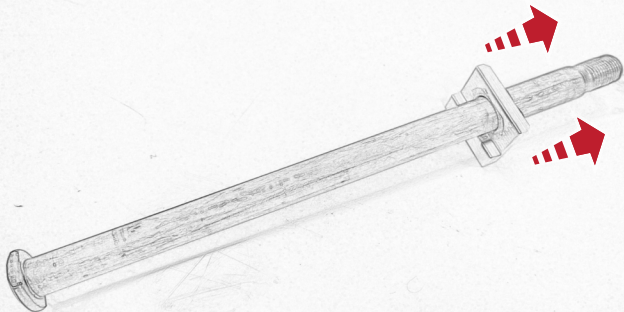

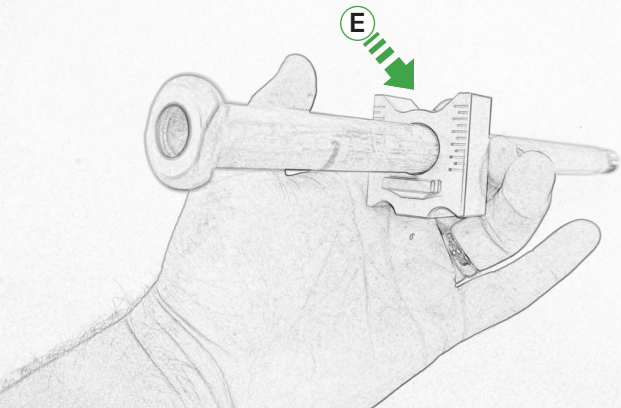

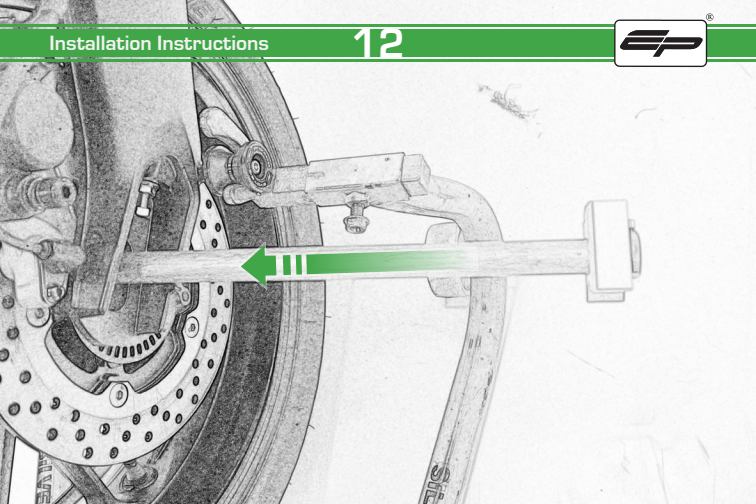

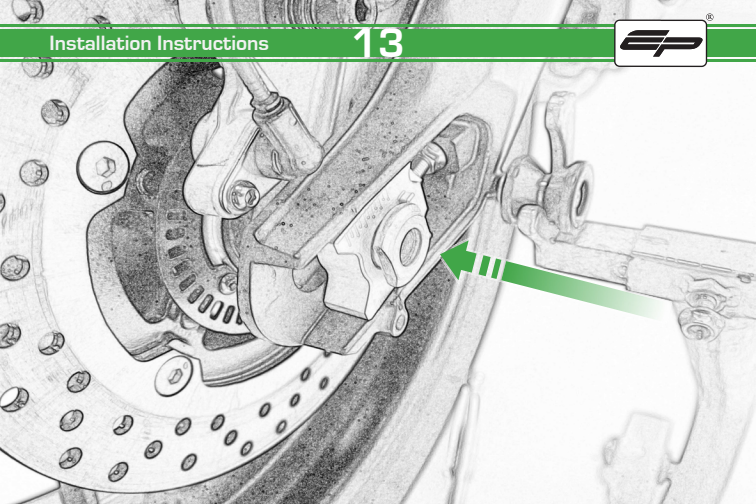

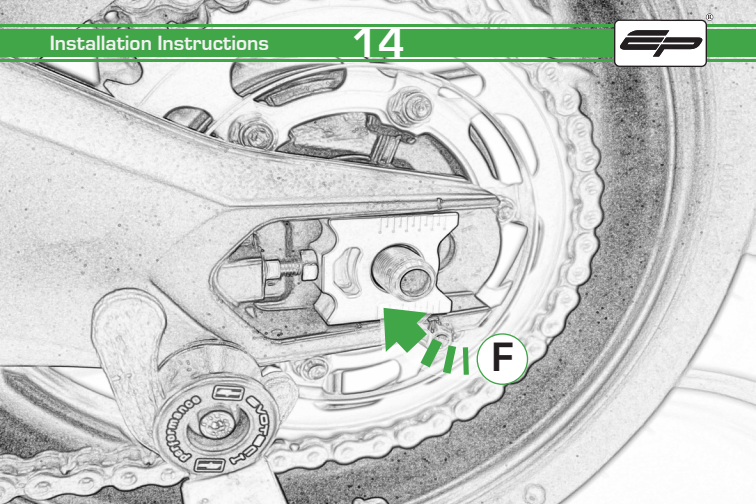



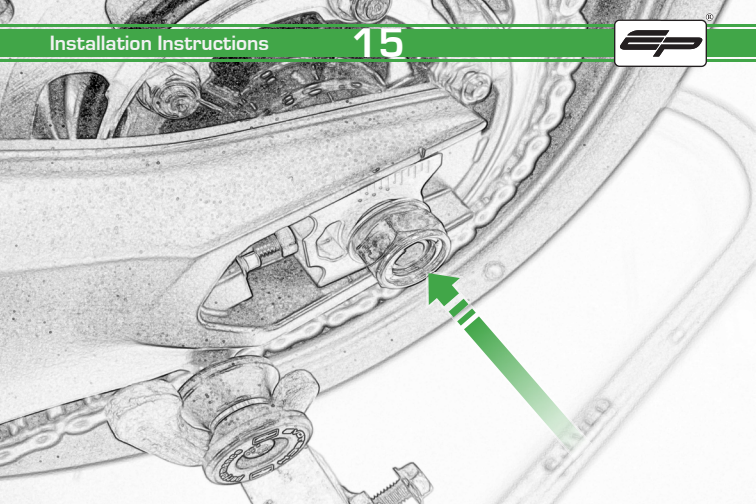

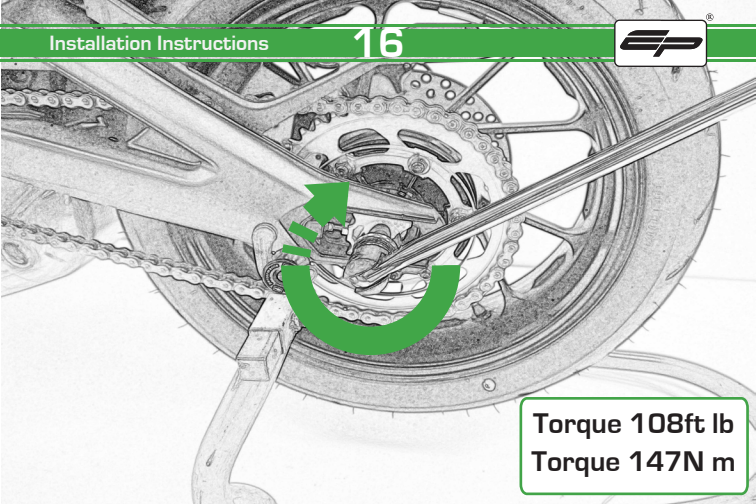

**Torque 108ft lb**  
**Torque 147N m**

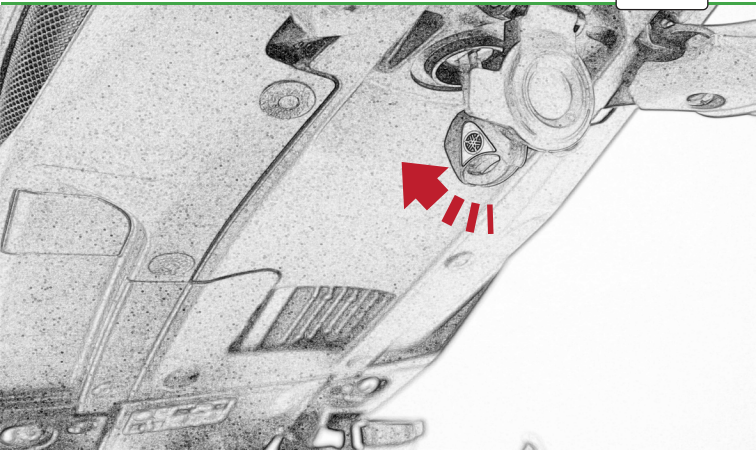

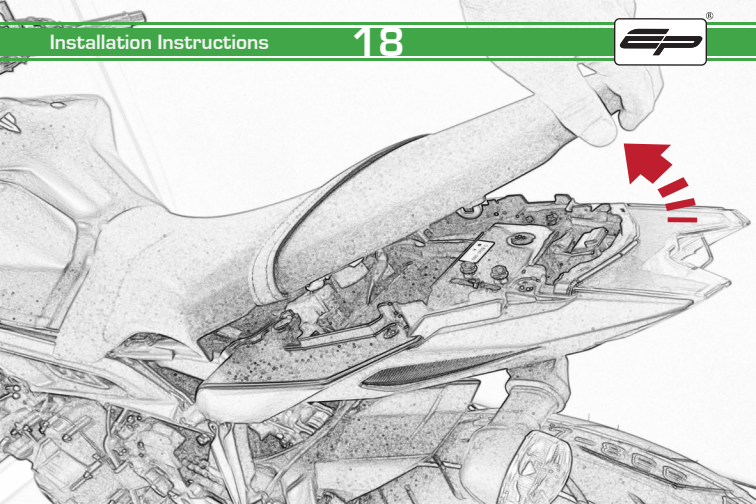

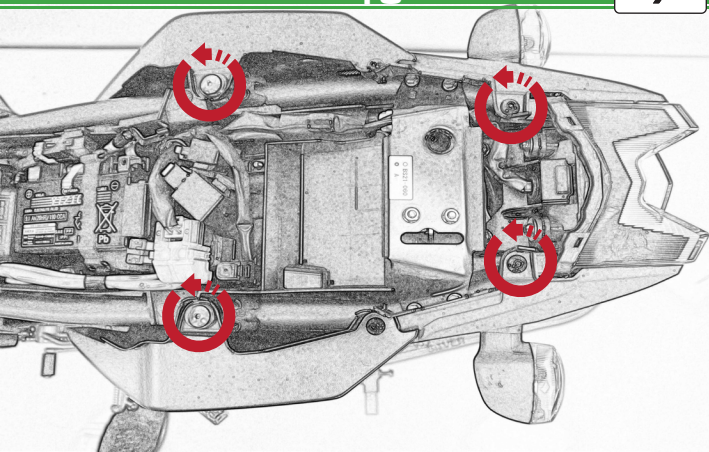



RELEASE



RE-SET



RE-FIT



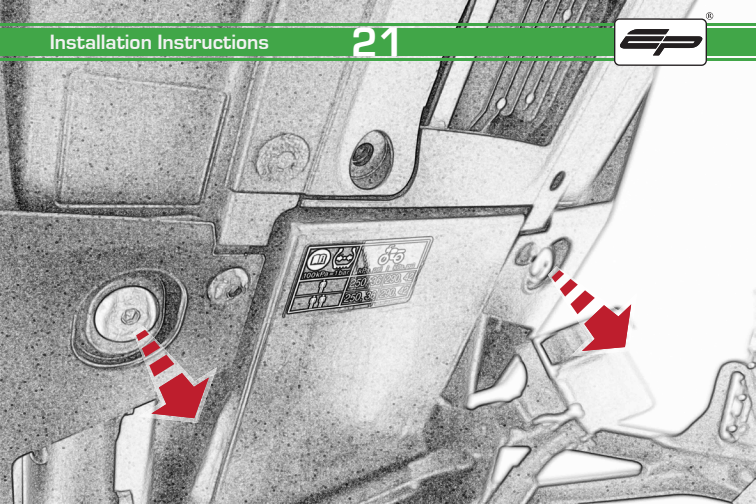

1000/110 - 1.6m	250/30/220 G	250/30/220 G

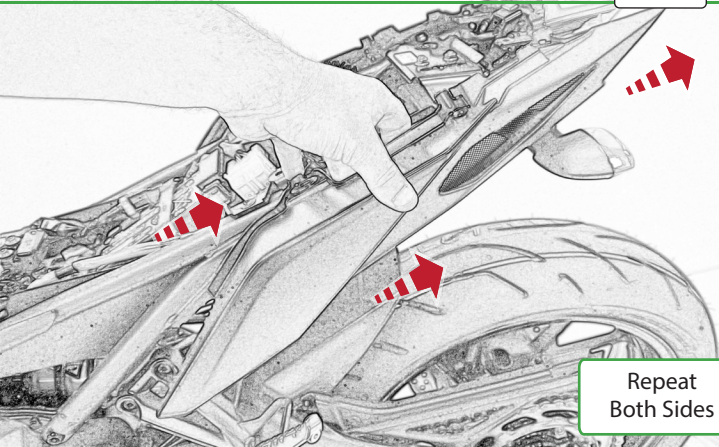

Repeat  
Both Sides



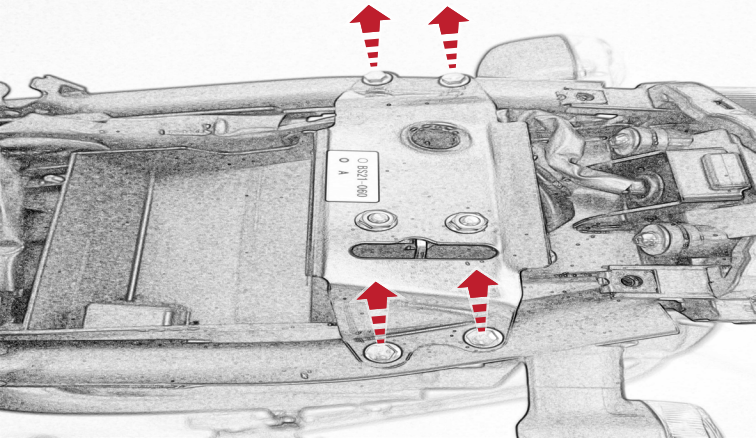

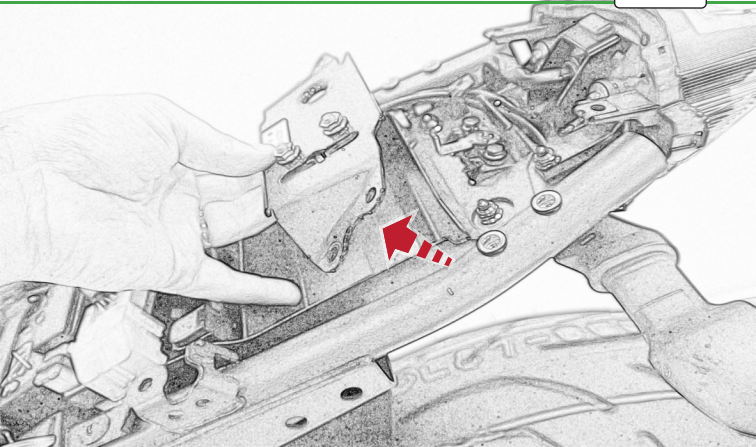

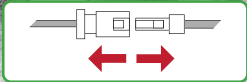
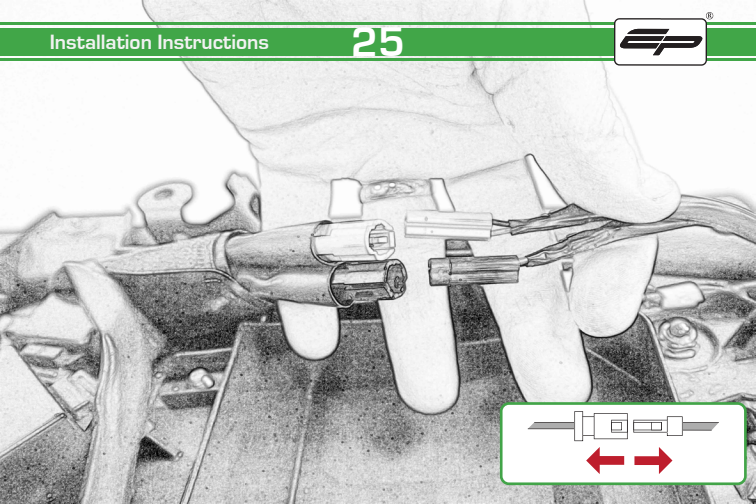

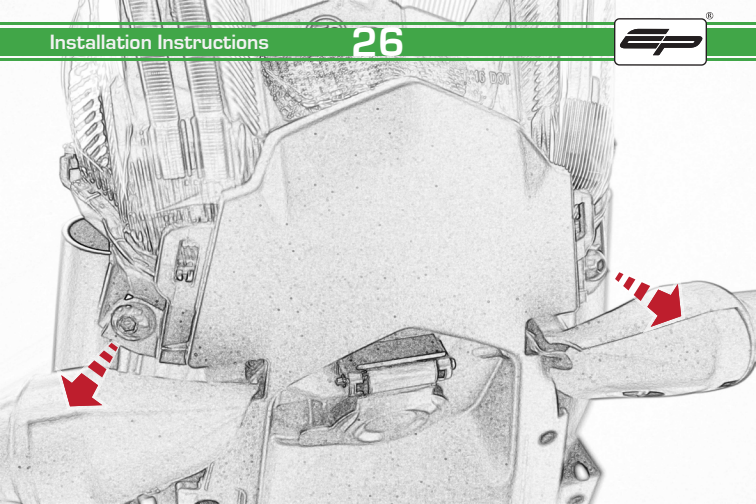

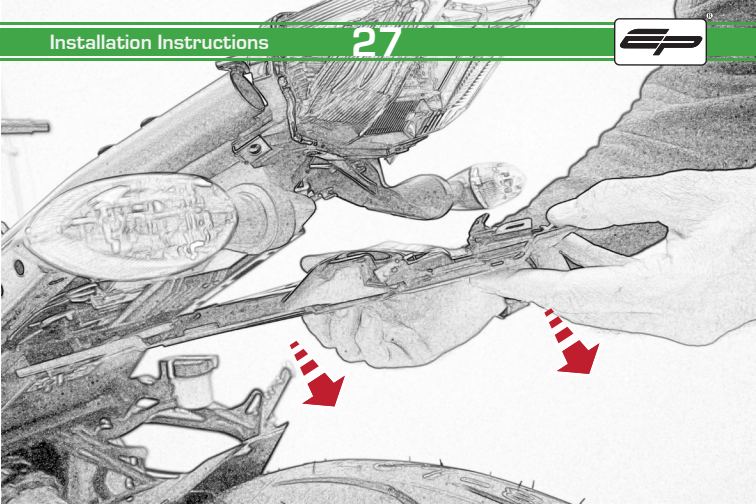

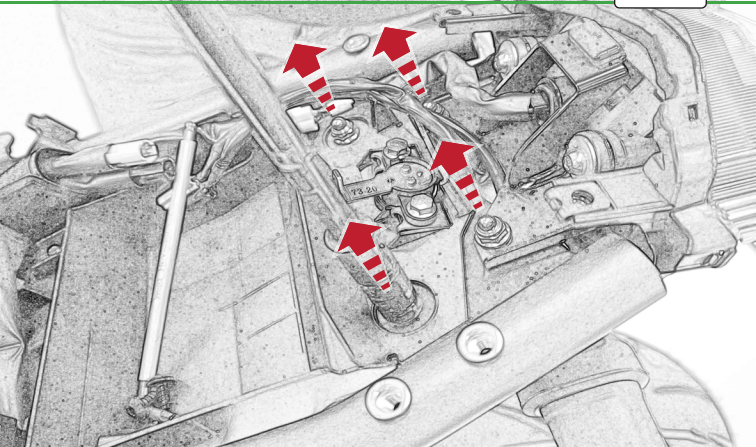

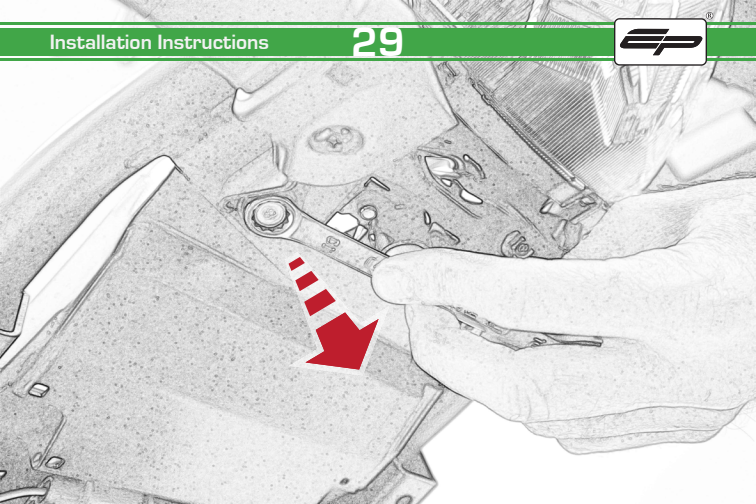

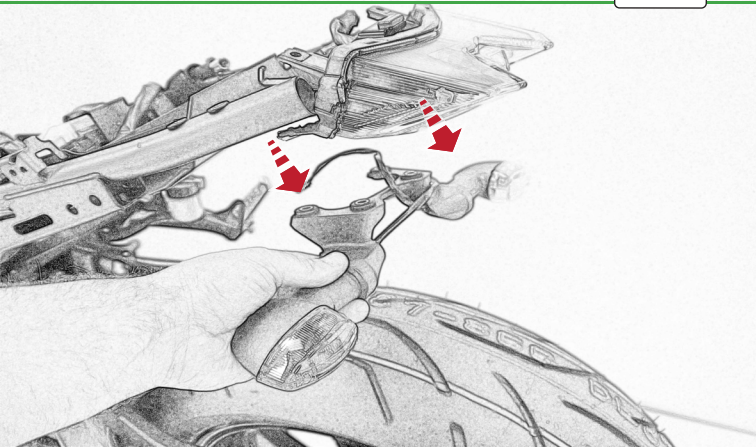



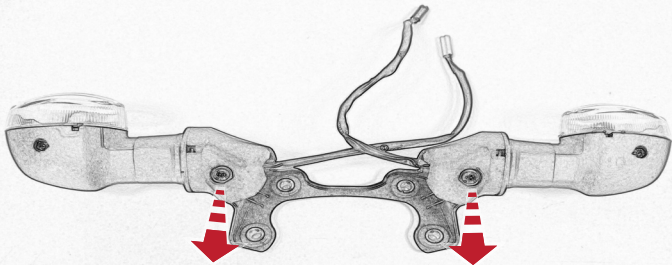

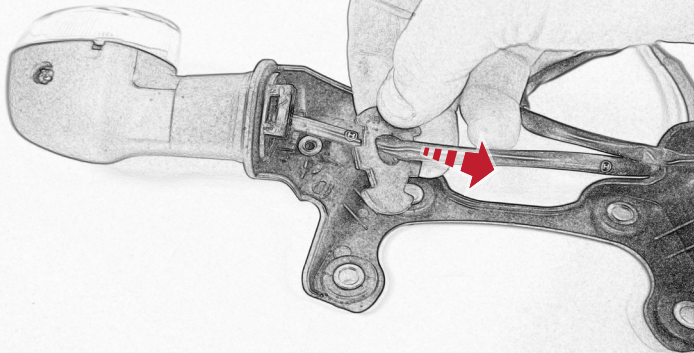

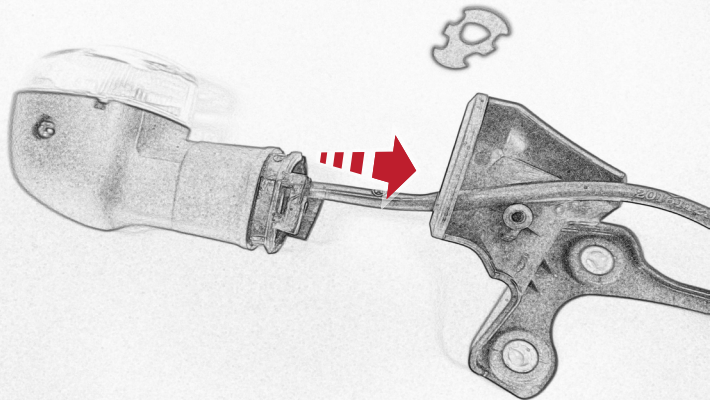

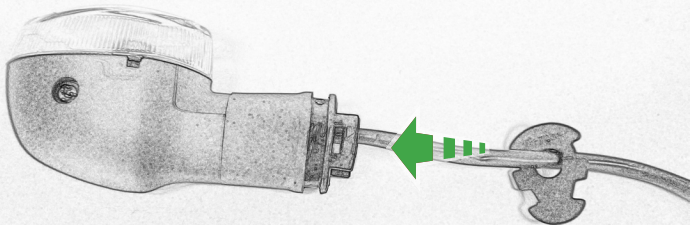

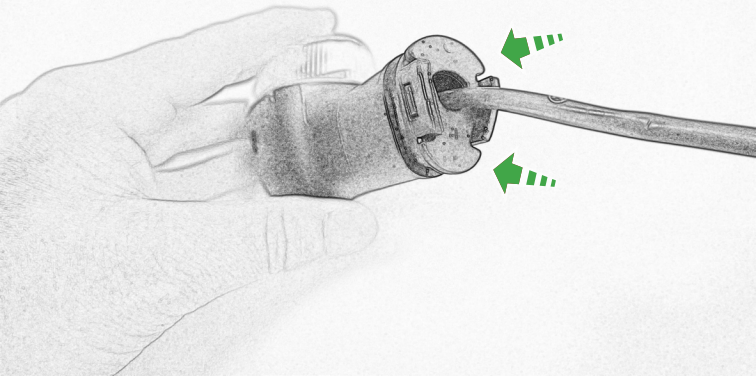

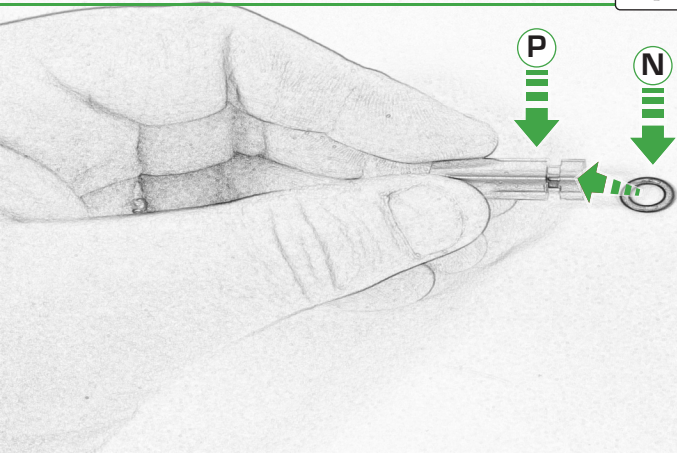

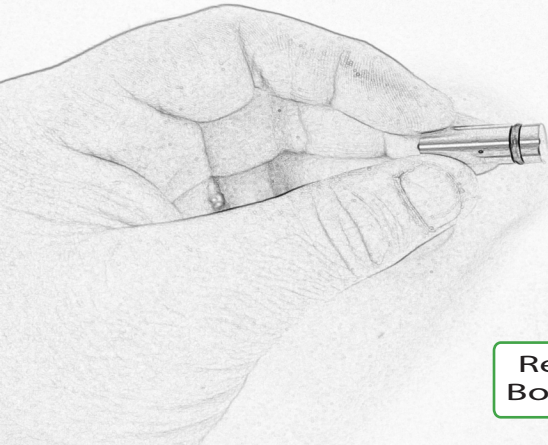

**Repeat For  
Both O-rings**

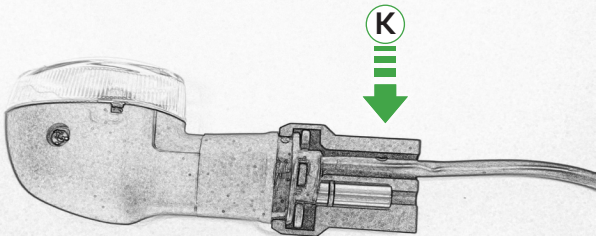

Repeat For  
Both Indicators



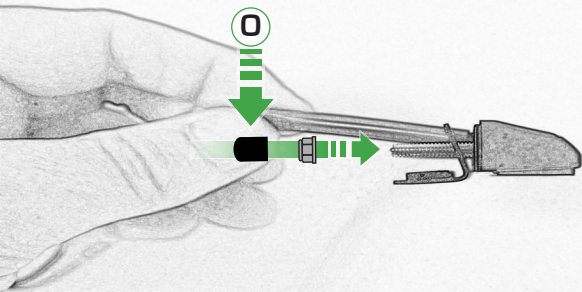

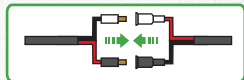
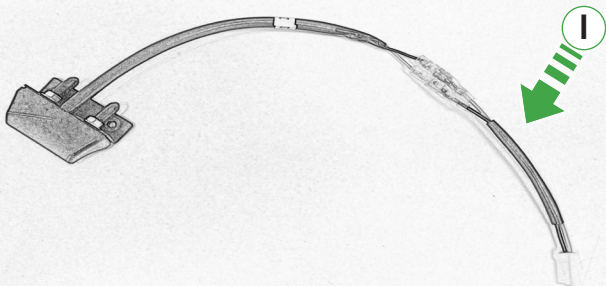

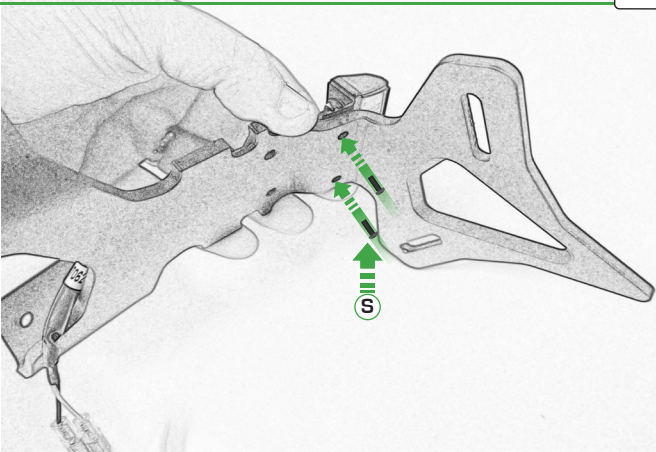

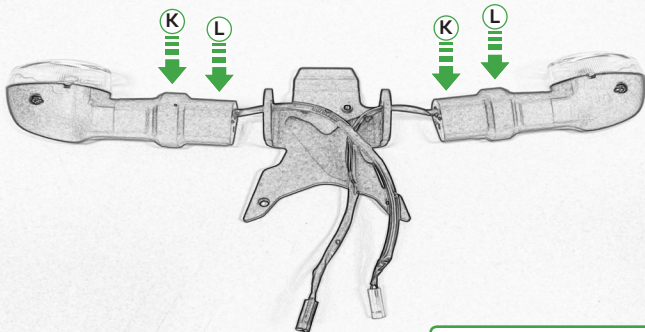

Caution

Ensure indicators are installed  
on the correct sides - drain  
holes should face down

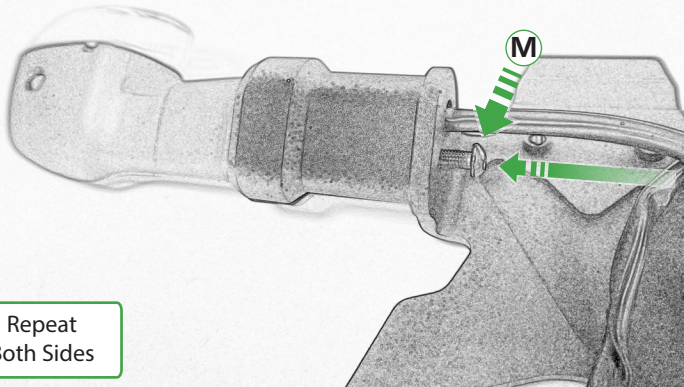

Repeat  
Both Sides

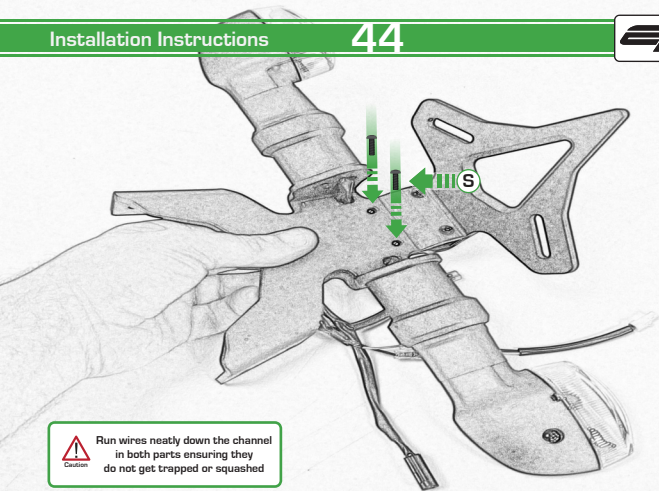

Run wires neatly down the channel  
in both parts ensuring they  
do not get trapped or squashed

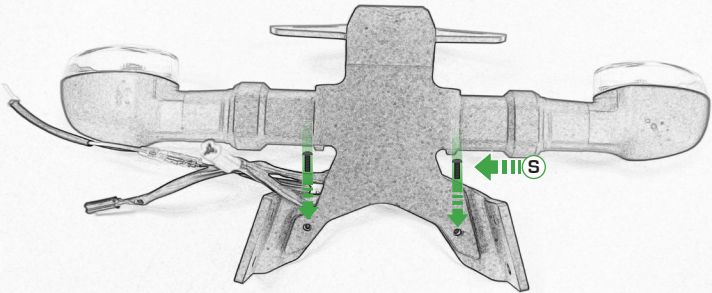

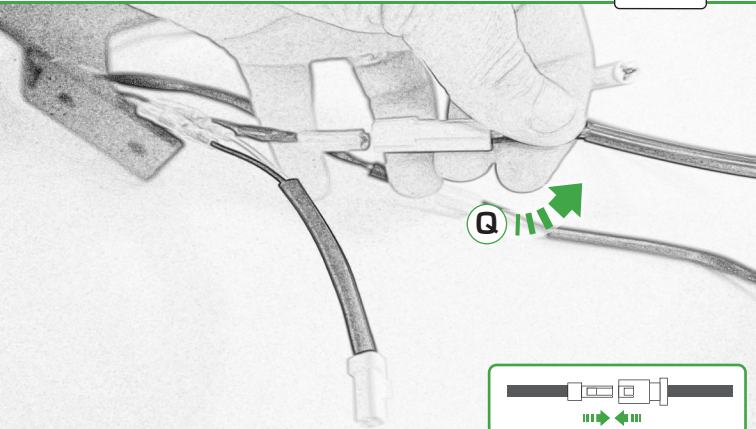



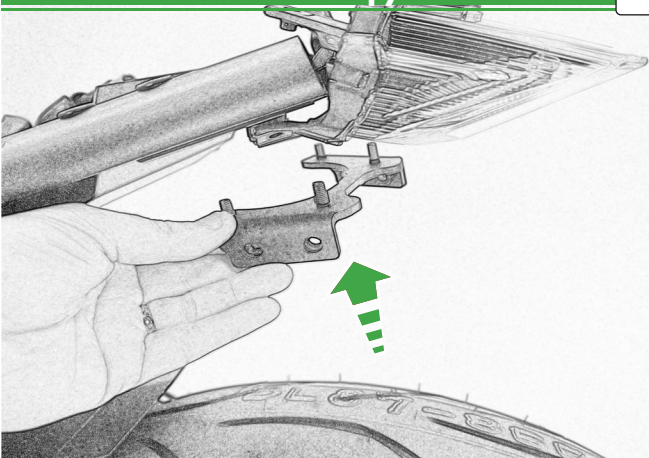

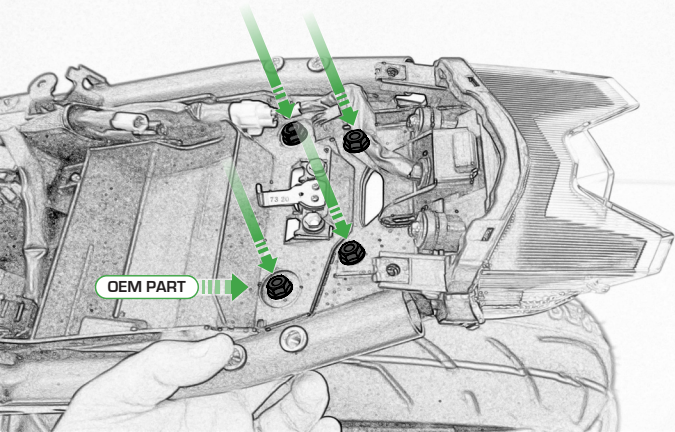

OEM PART

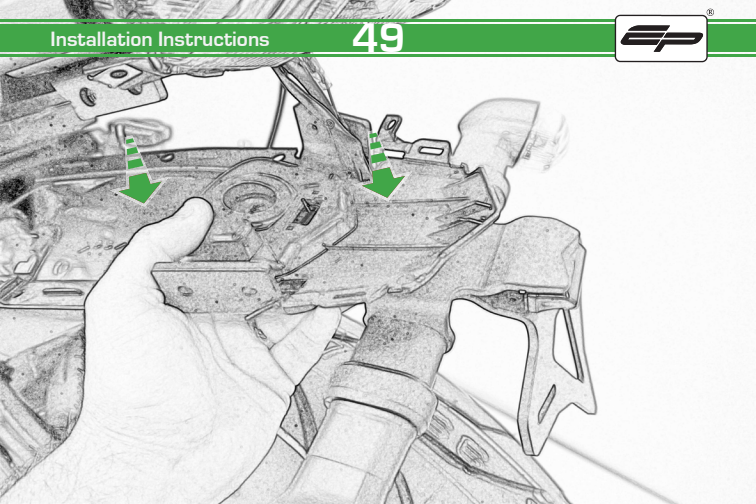

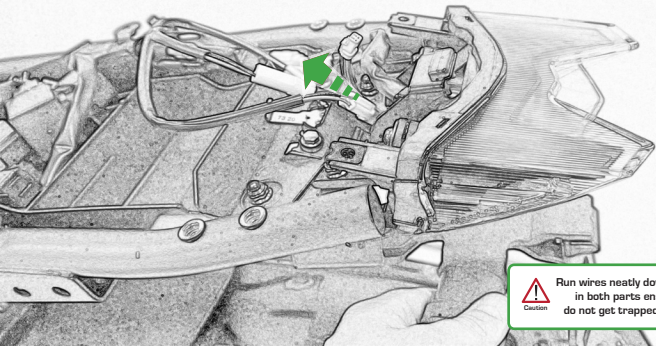

Caution

Run wires neatly down the channel  
in both parts ensuring they  
do not get trapped or squashed

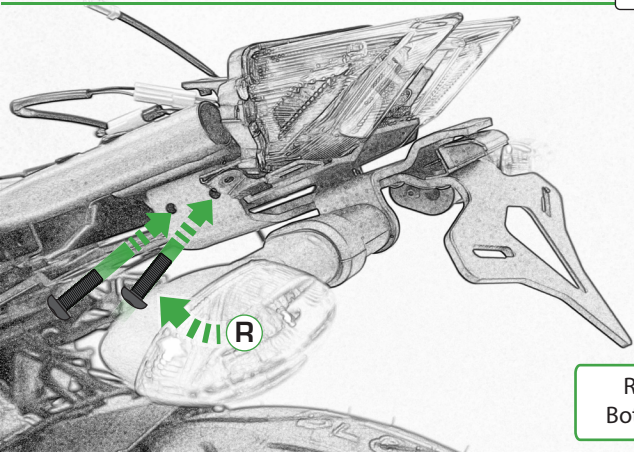

Repeat  
Both Sides



OEM PART



Repeat  
Both Sides

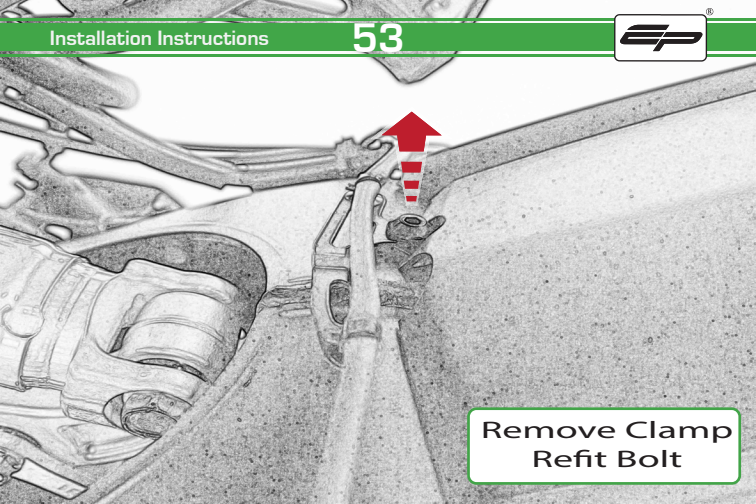

Remove Clamp  
Refit Bolt





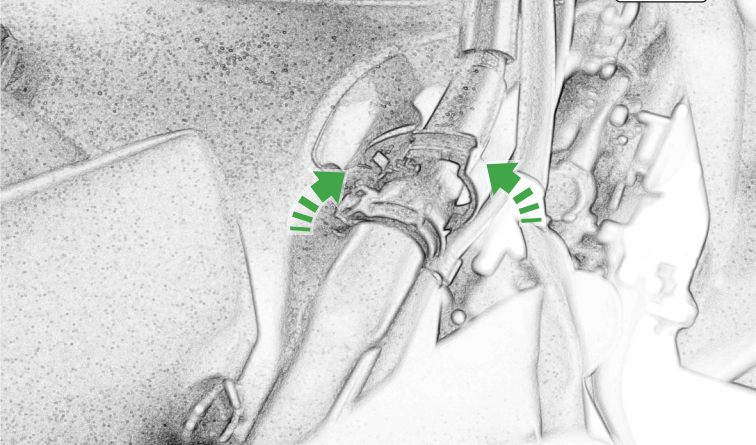

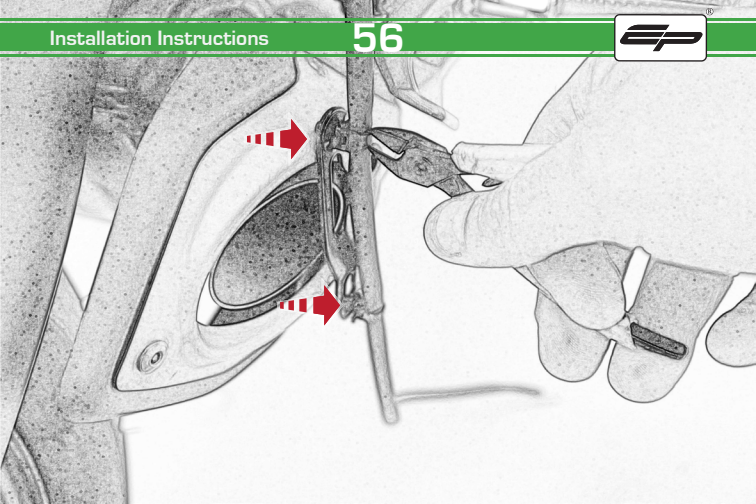

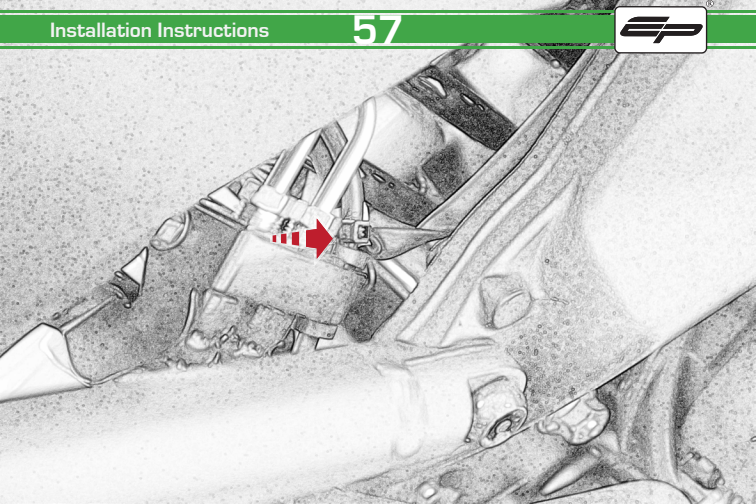

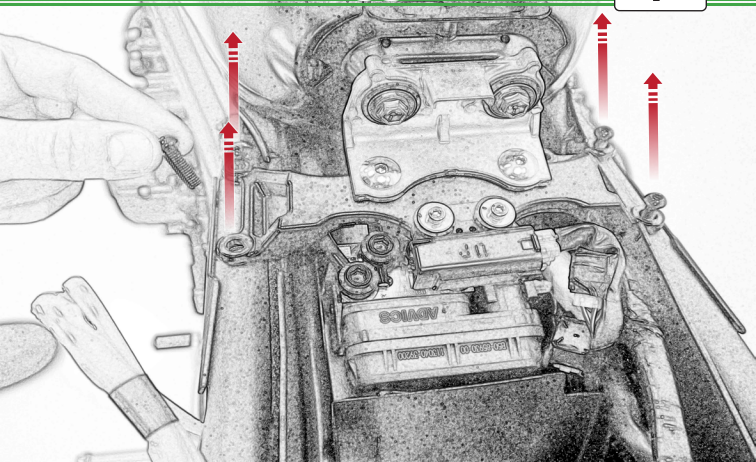

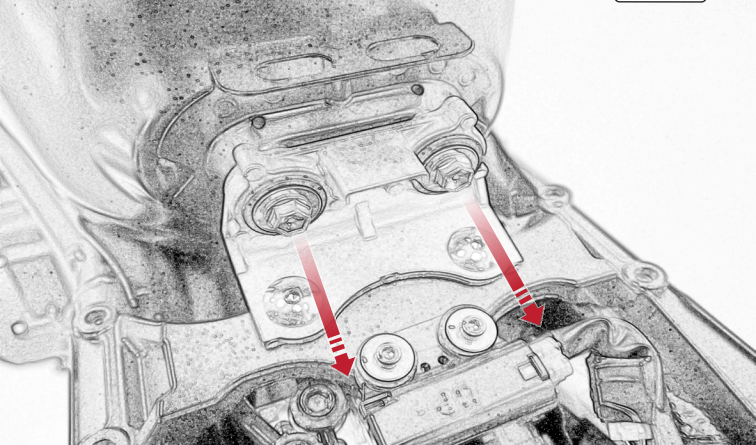

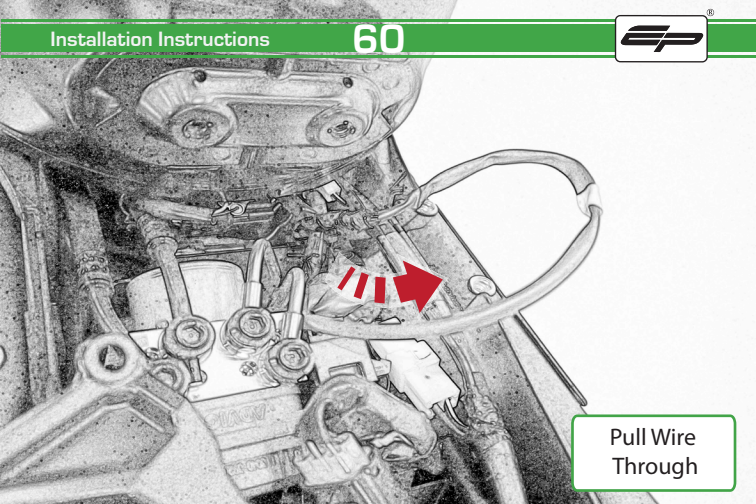

Pull Wire  
Through

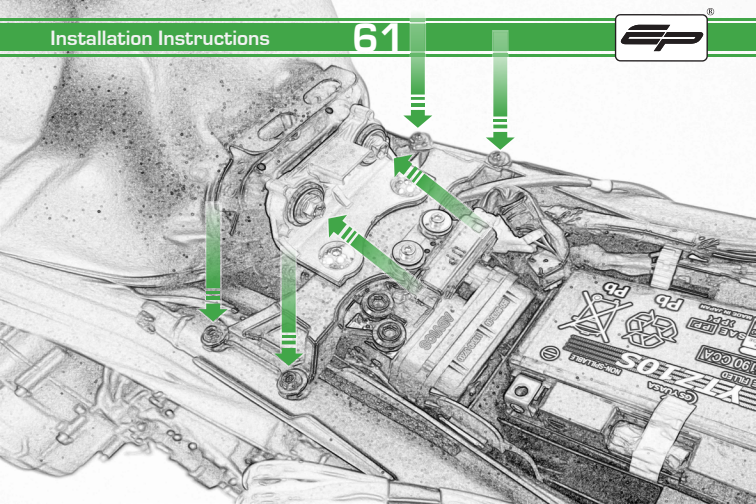

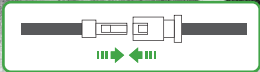
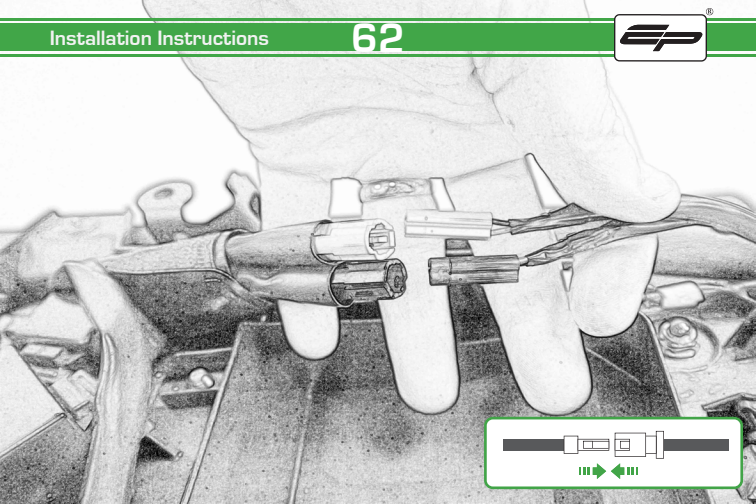





Reverse Stages

24 - 18

