

**EVOTECH**®  
P E R F O R M A N C E

[www.evotech-performance.com](http://www.evotech-performance.com)

Ducati Streetfighter Tail Tidy

Installation Instructions



## Kit Contents

- (A) 1 x Reflector Kit
- (B) 1 x Con 10
- (C) 1 x Retro Light
- (D) 1 x M3 x 10 Button Head Bolt
- (E) 2 x M4 Nuts
- (F) 2 x M5 x 12 Button Head Bolt
- (G) 2 x M6 x 16 Button Head Bolt
- (H) 2 x M5 x 16 Button Head Bolt
- (I) 2 x M5 x 65 Caphead Bolt (Double Stem Version)
- (J) 2 x M5 x 45 Caphead Bolt (Single Stem Version)
- (K) 2 x Indicator Adaptors
- (L) 4 x Indicator Stems
- (M) 4 x Indicator Clamps

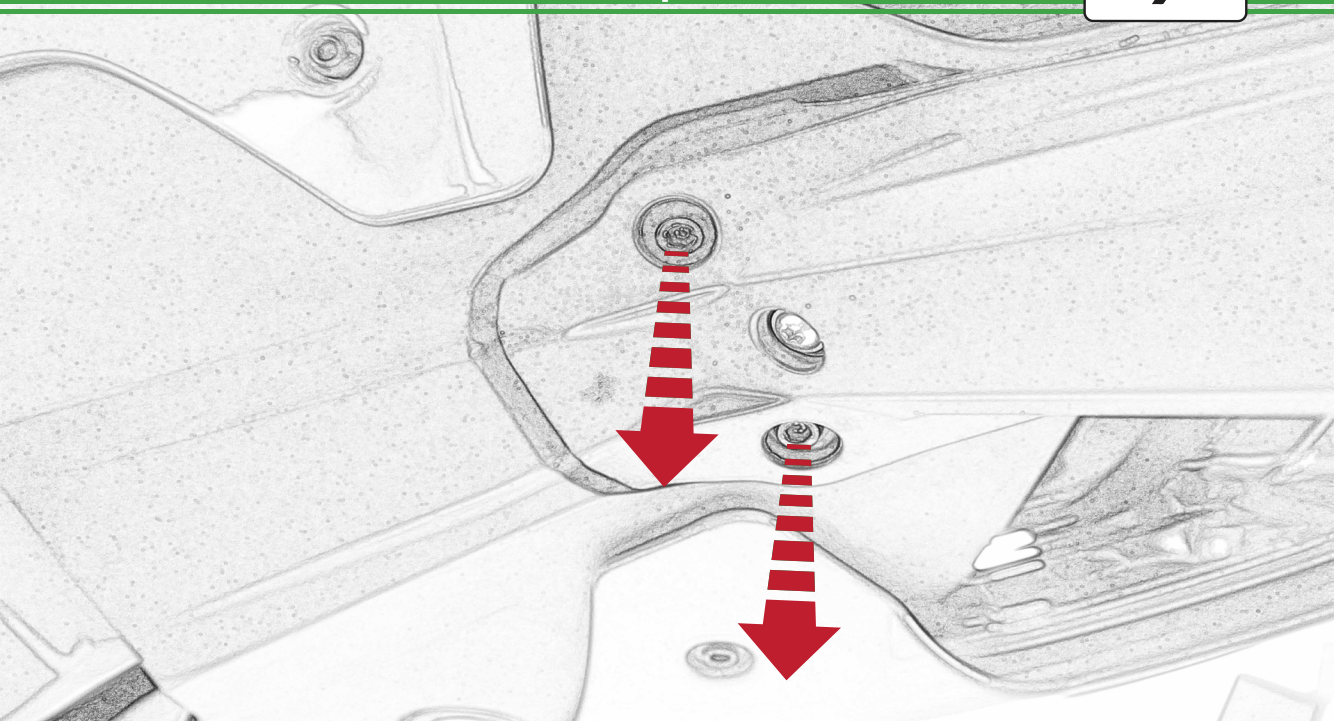

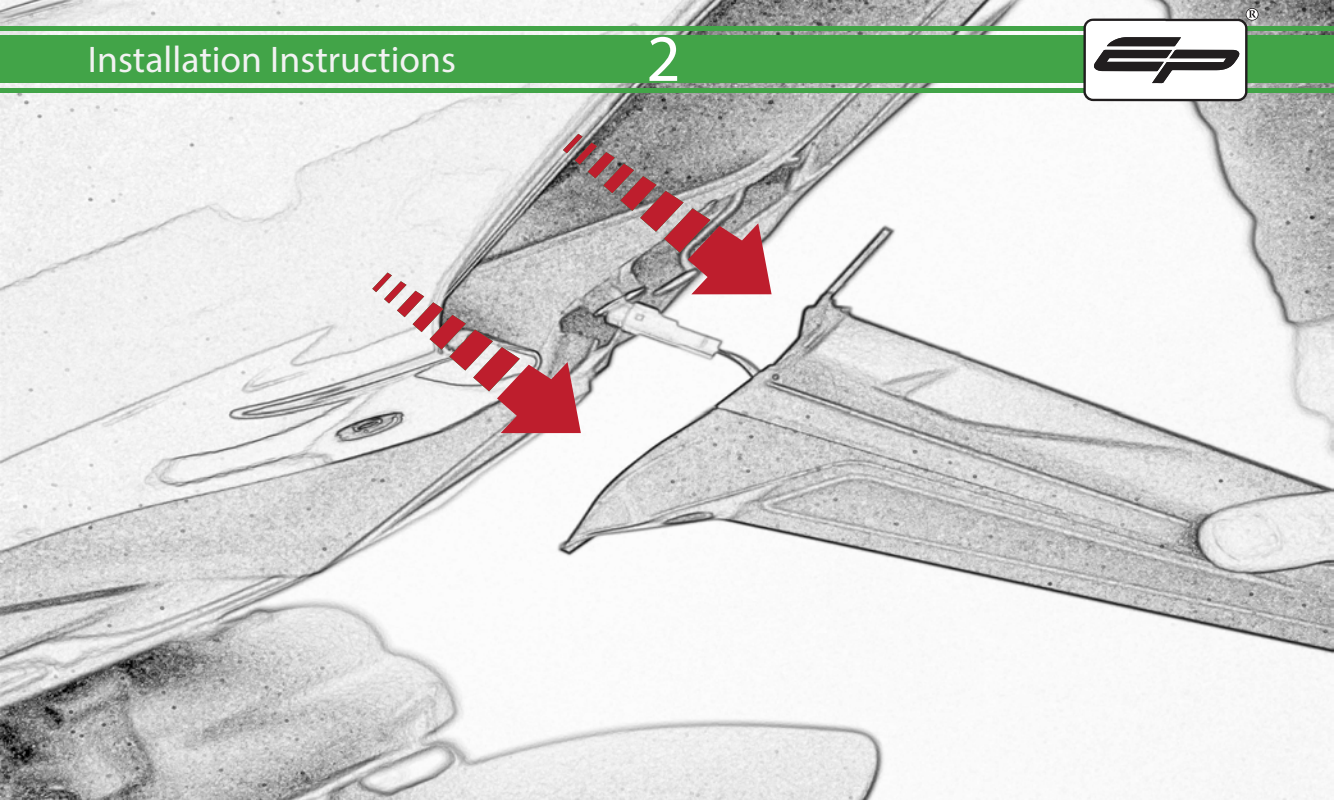



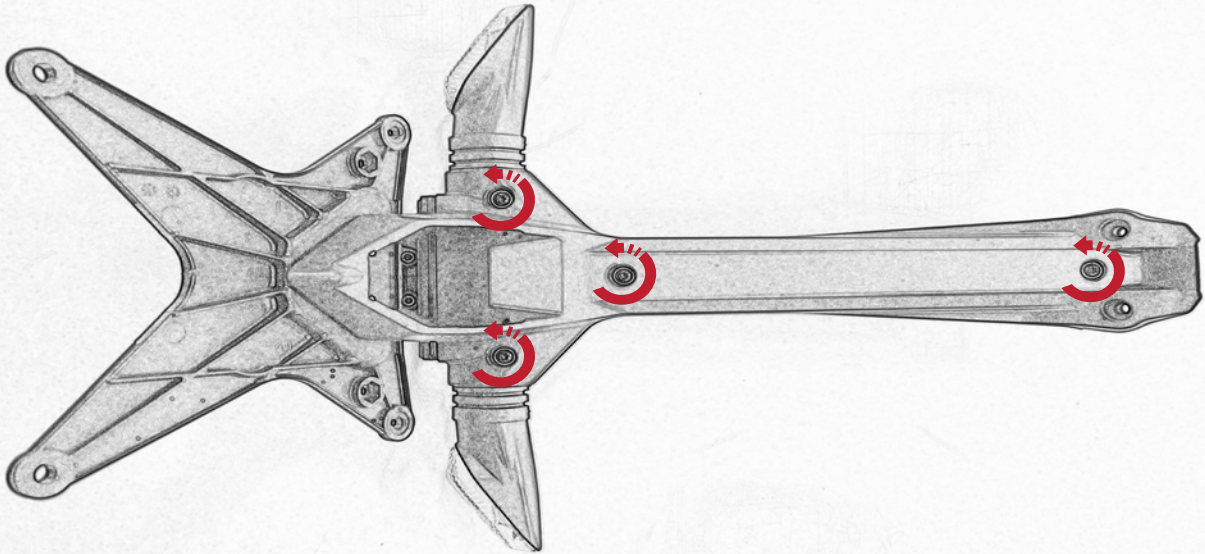

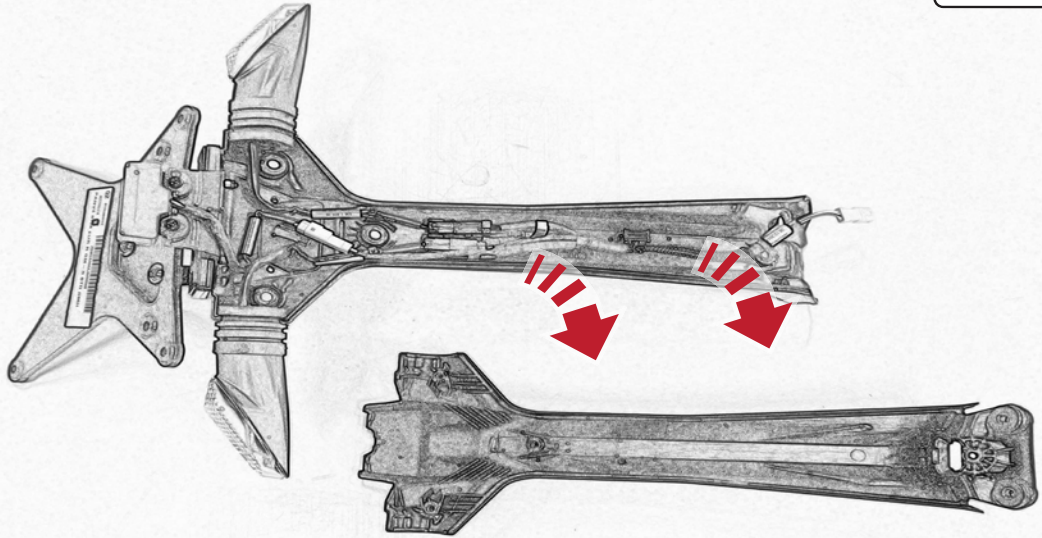

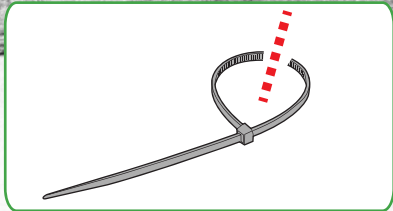
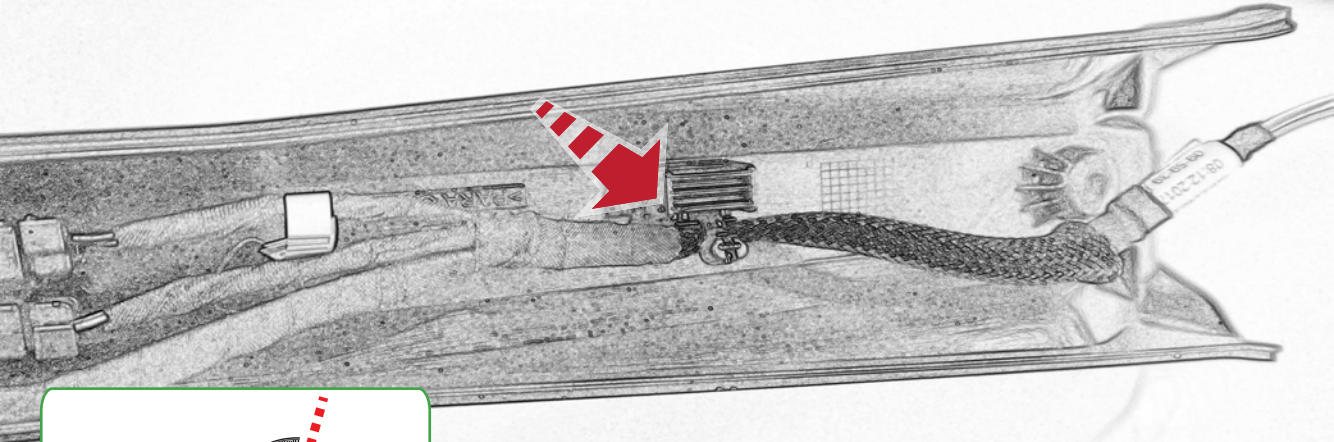

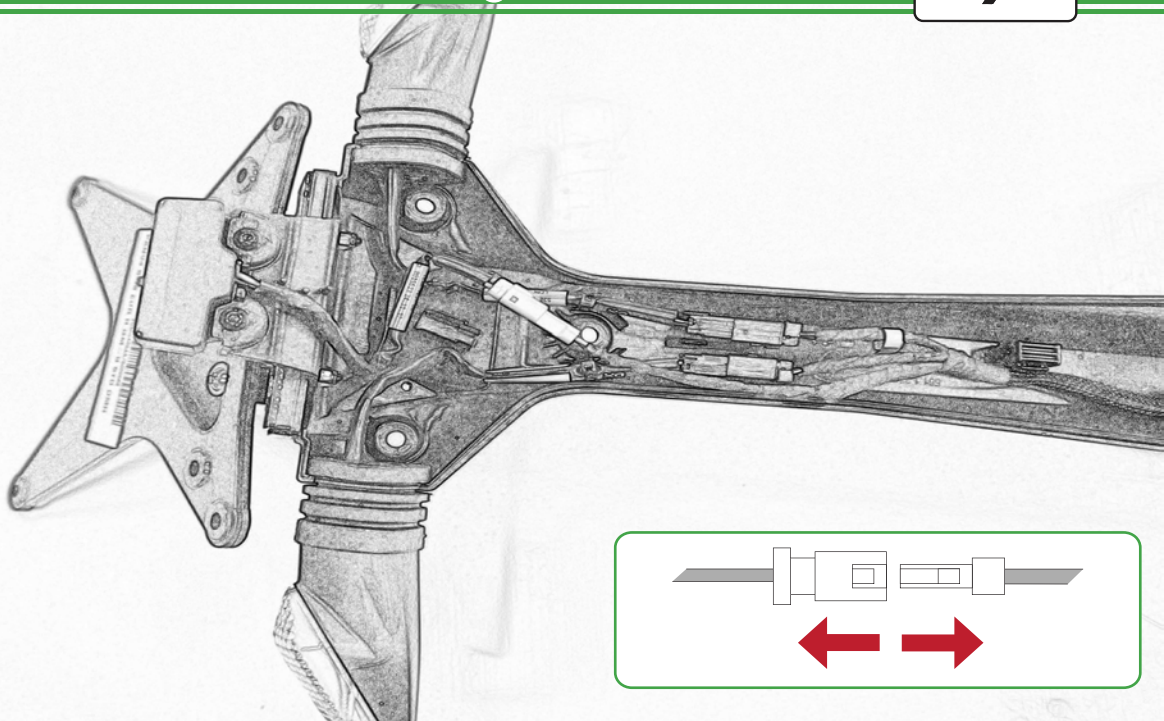

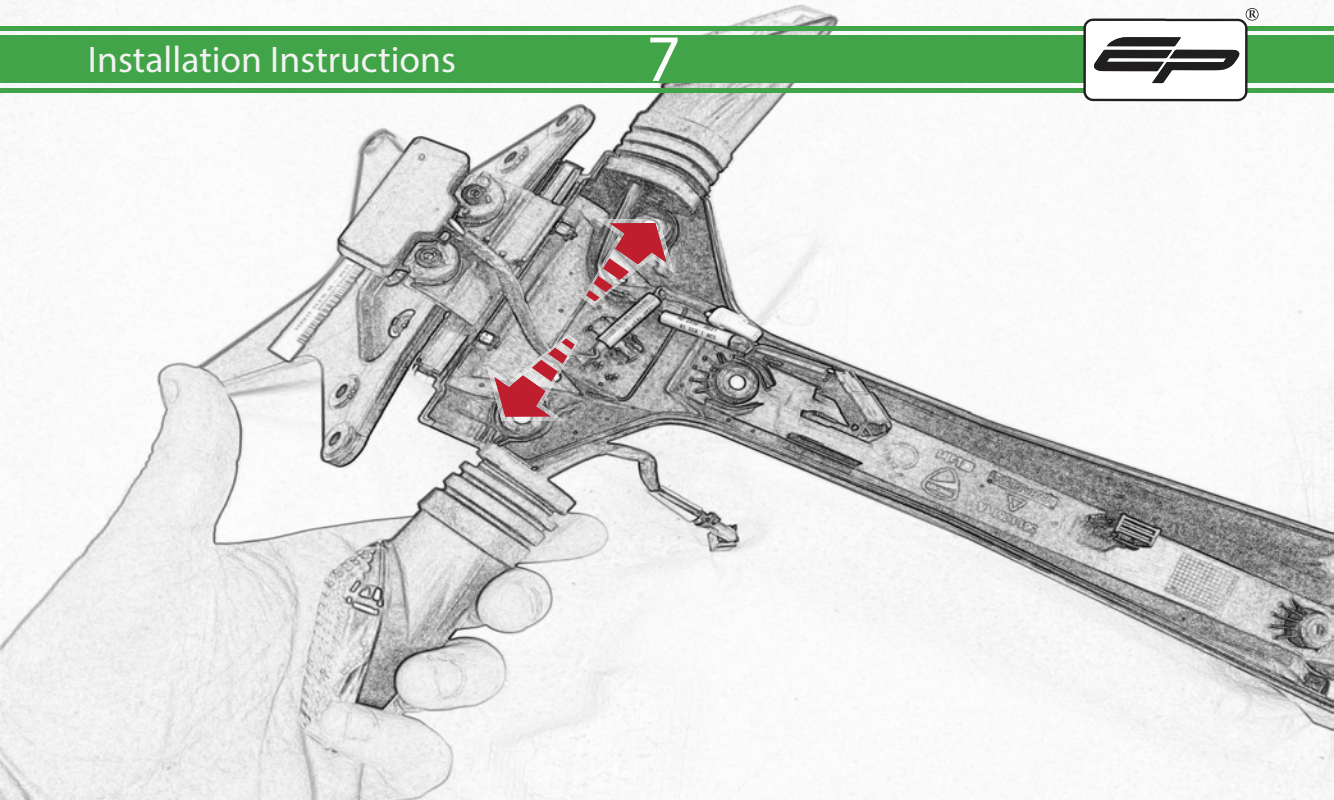



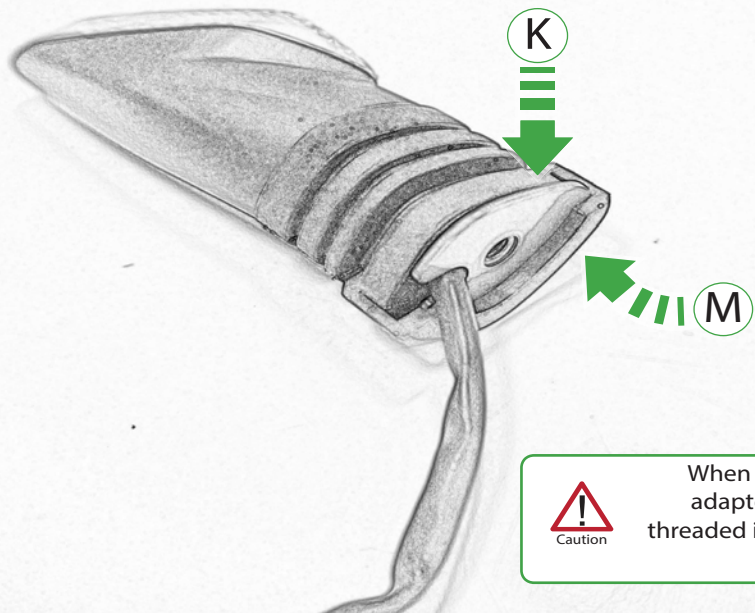



Repeat  
Both Sides

 Caution

When fitting the indicator adaptor plate ensure the threaded insert is facing towards the indicator

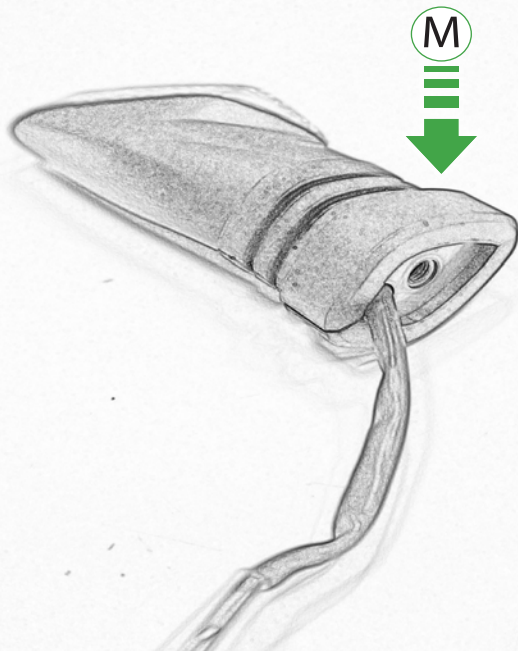

Repeat  
Both Sides



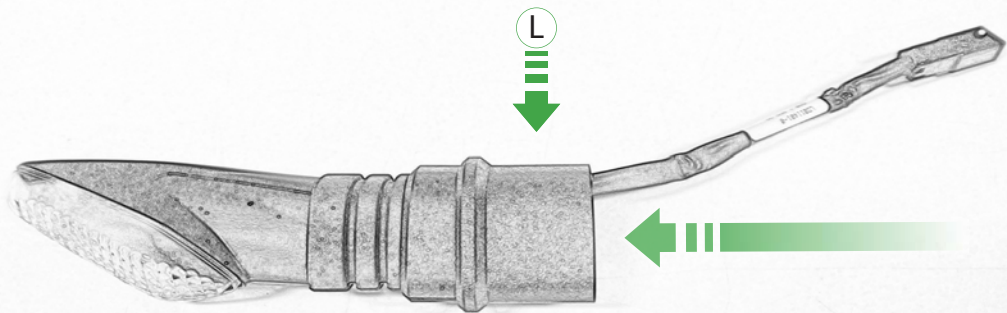

Repeat  
Both Sides

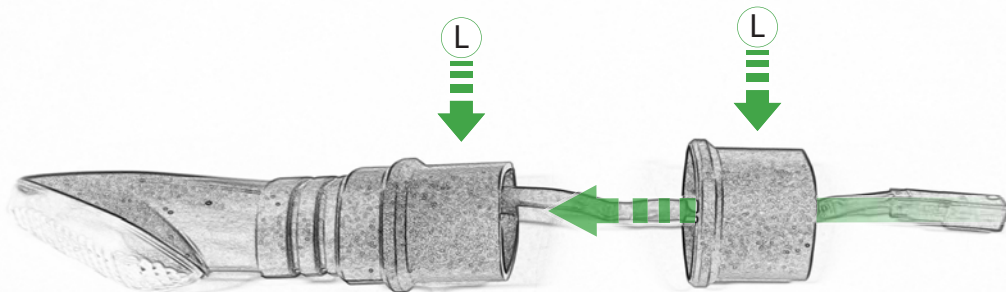

Repeat  
Both Sides



Second stem only required  
for large numberplates

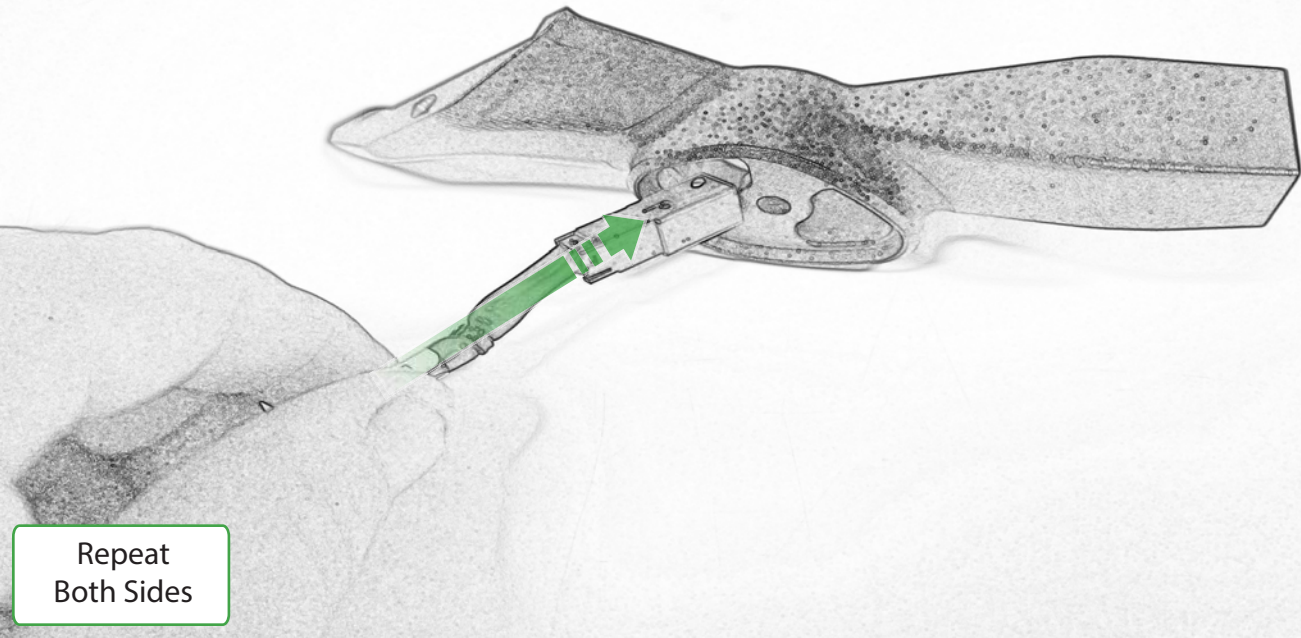

Repeat  
Both Sides

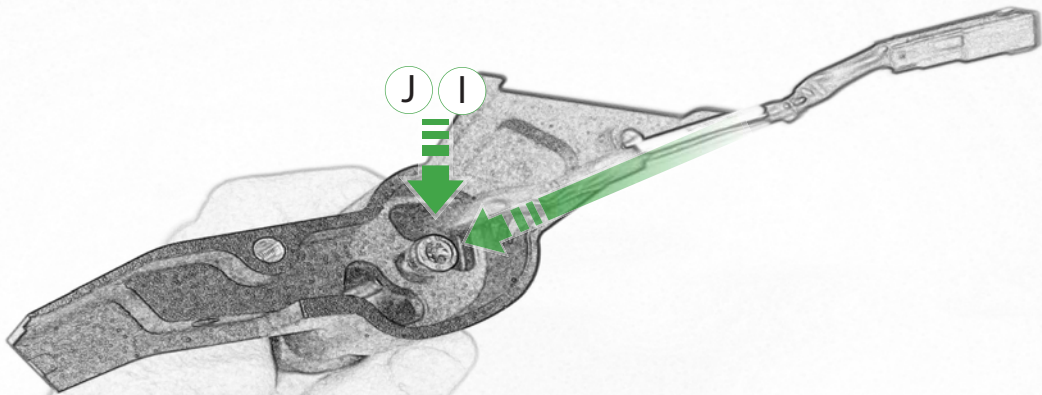

Repeat  
Both Sides

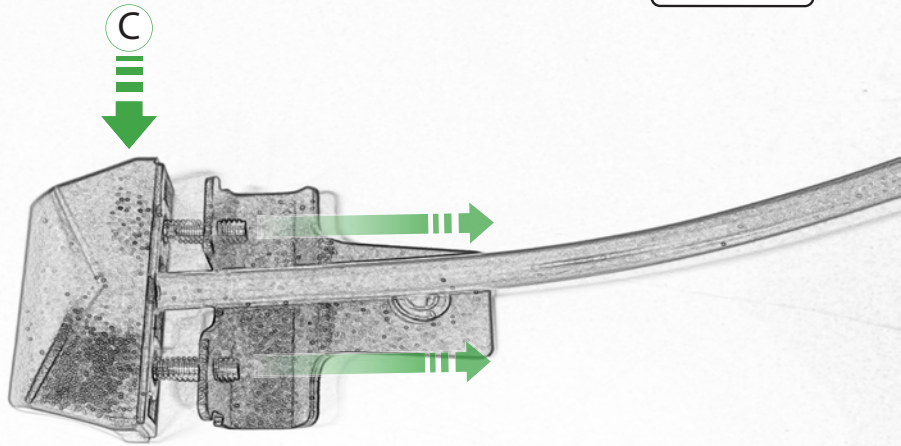

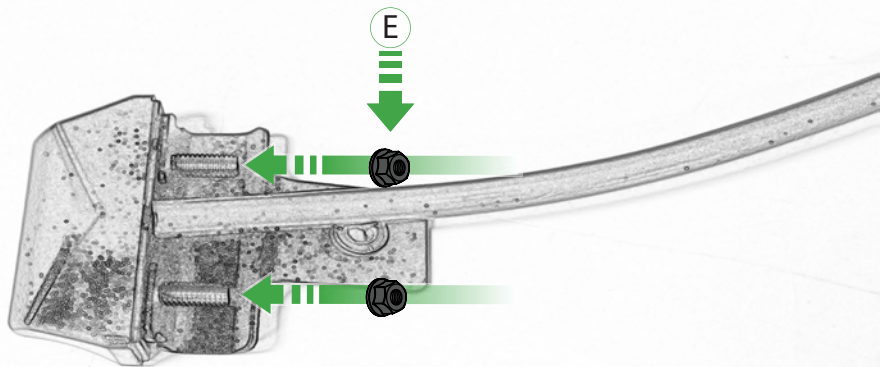

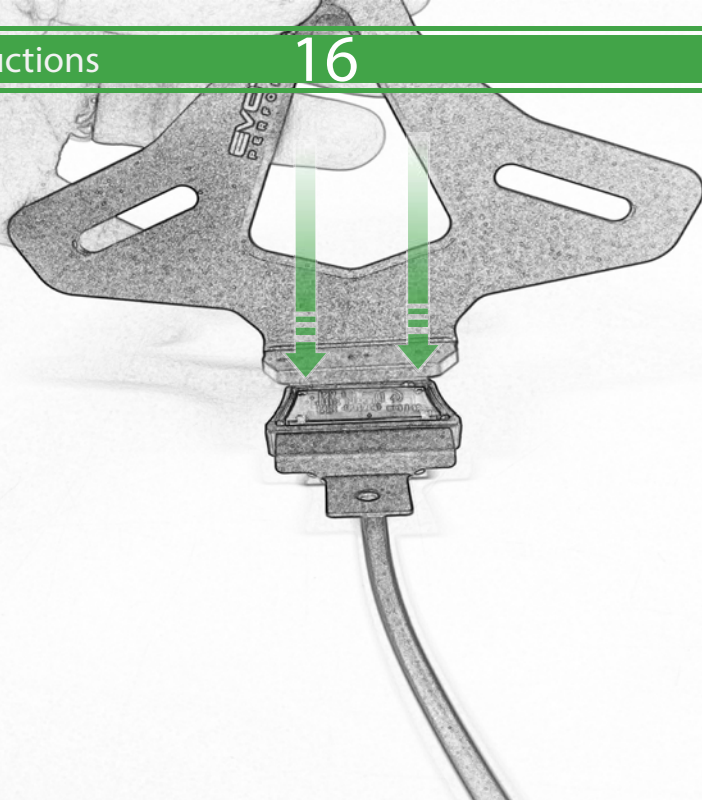



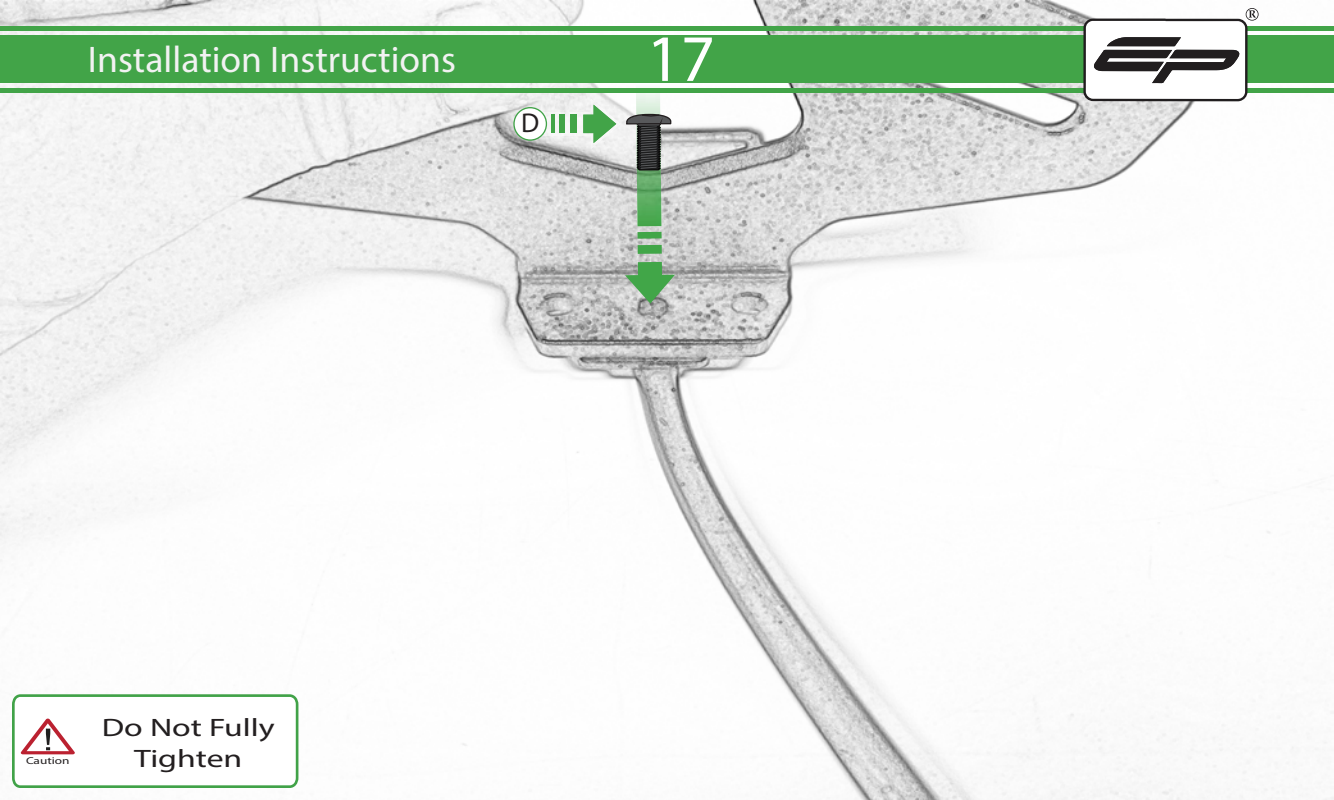

Caution

Do Not Fully Tighten

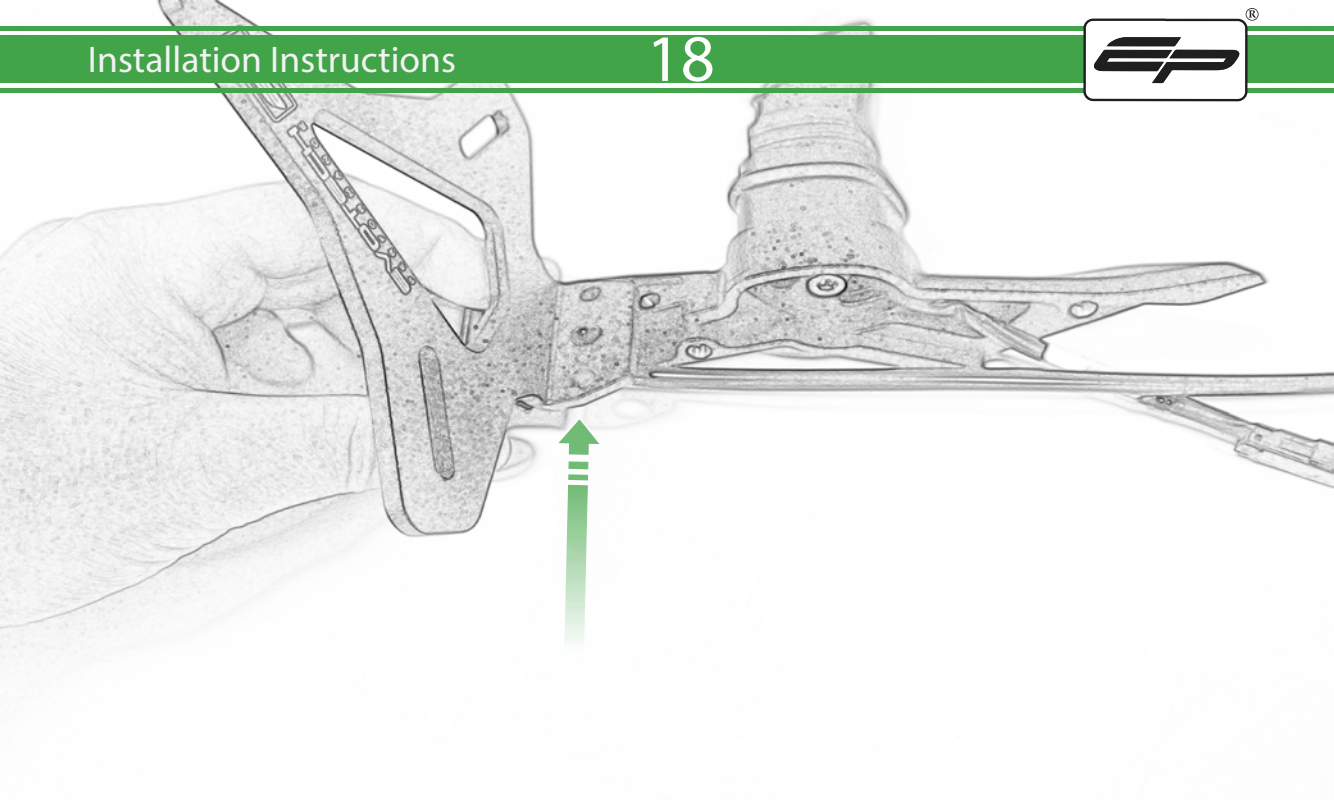

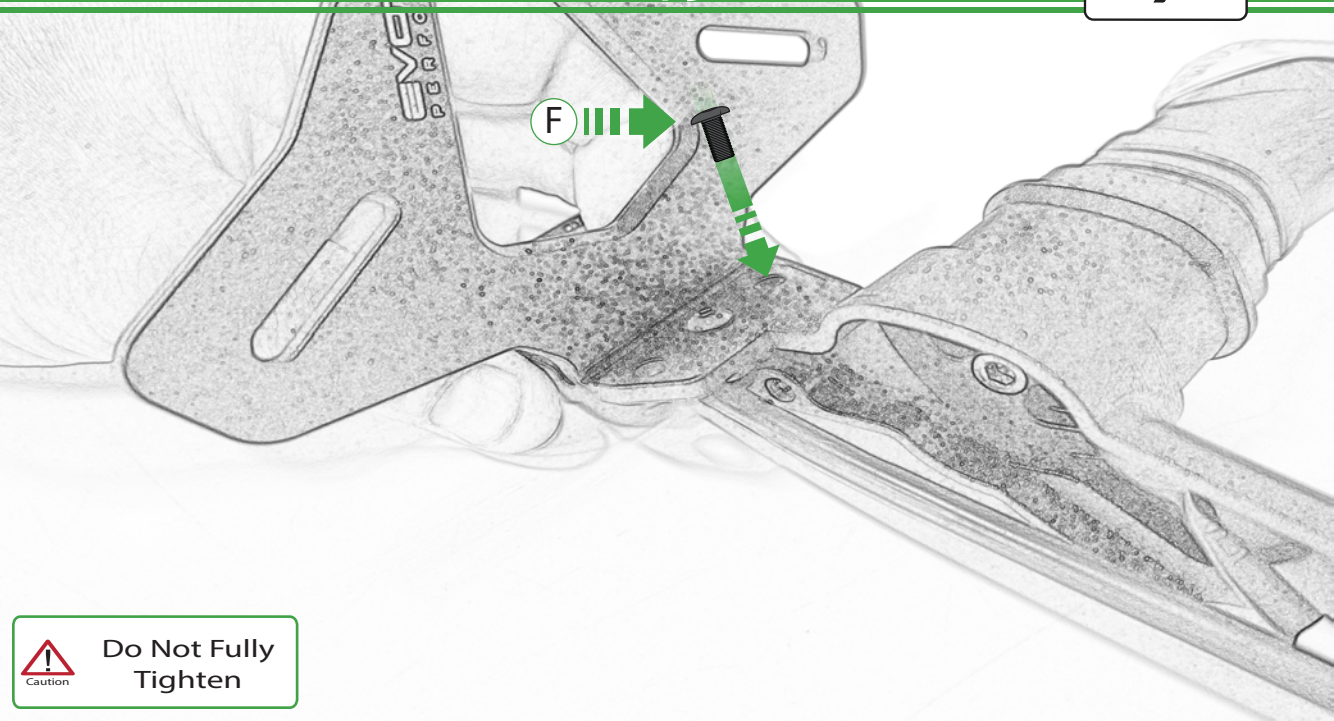

Caution

Do Not Fully  
Tighten

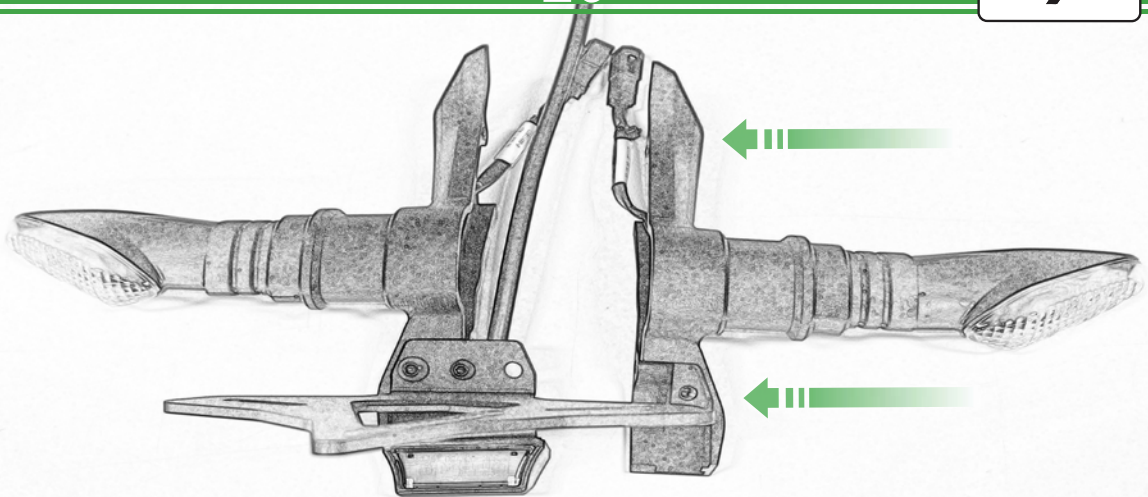

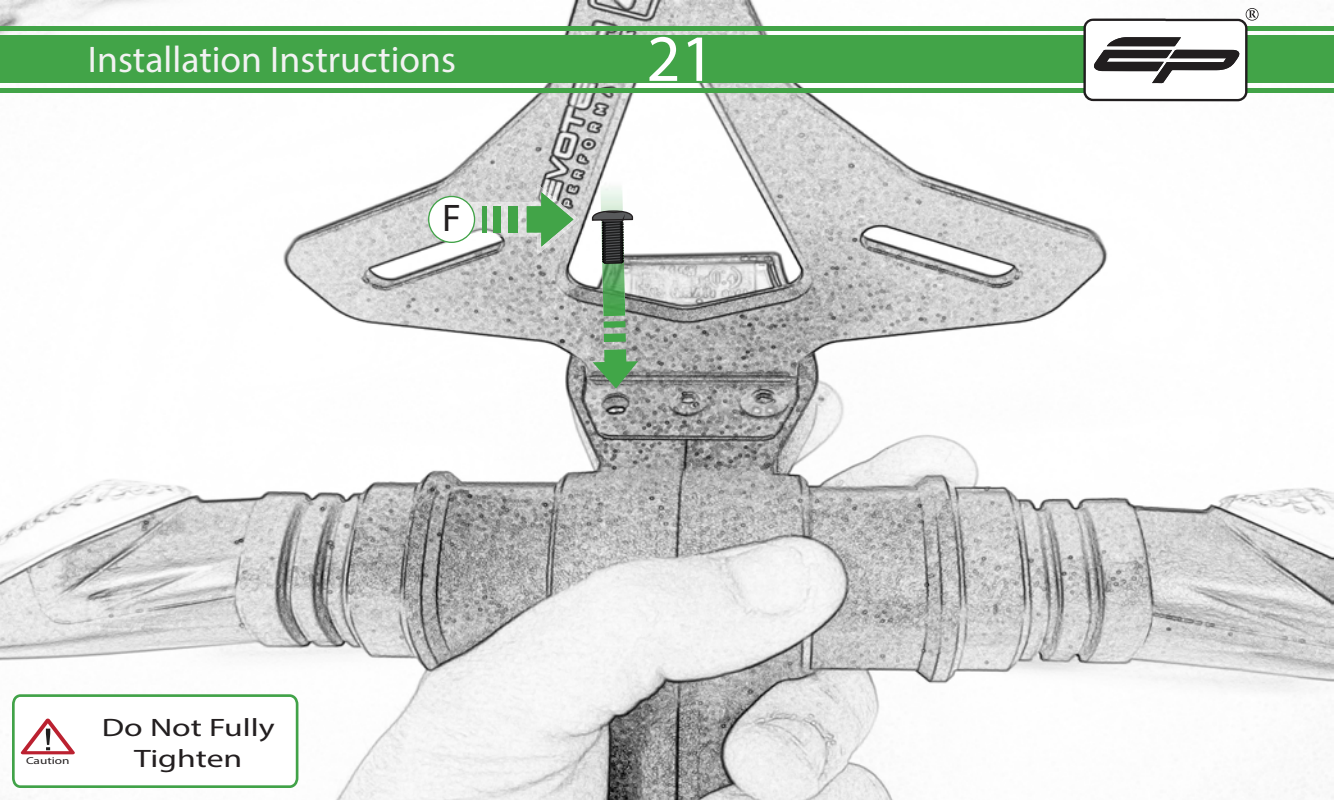

Do Not Fully Tighten

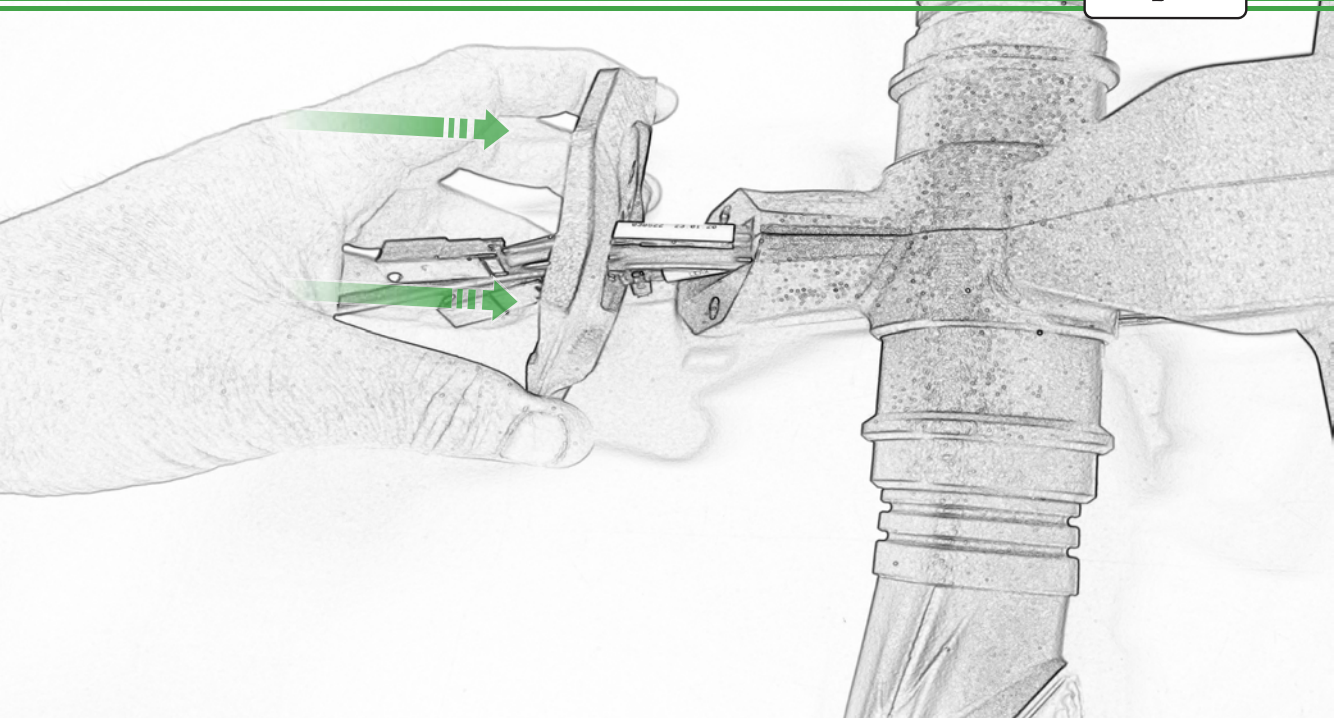



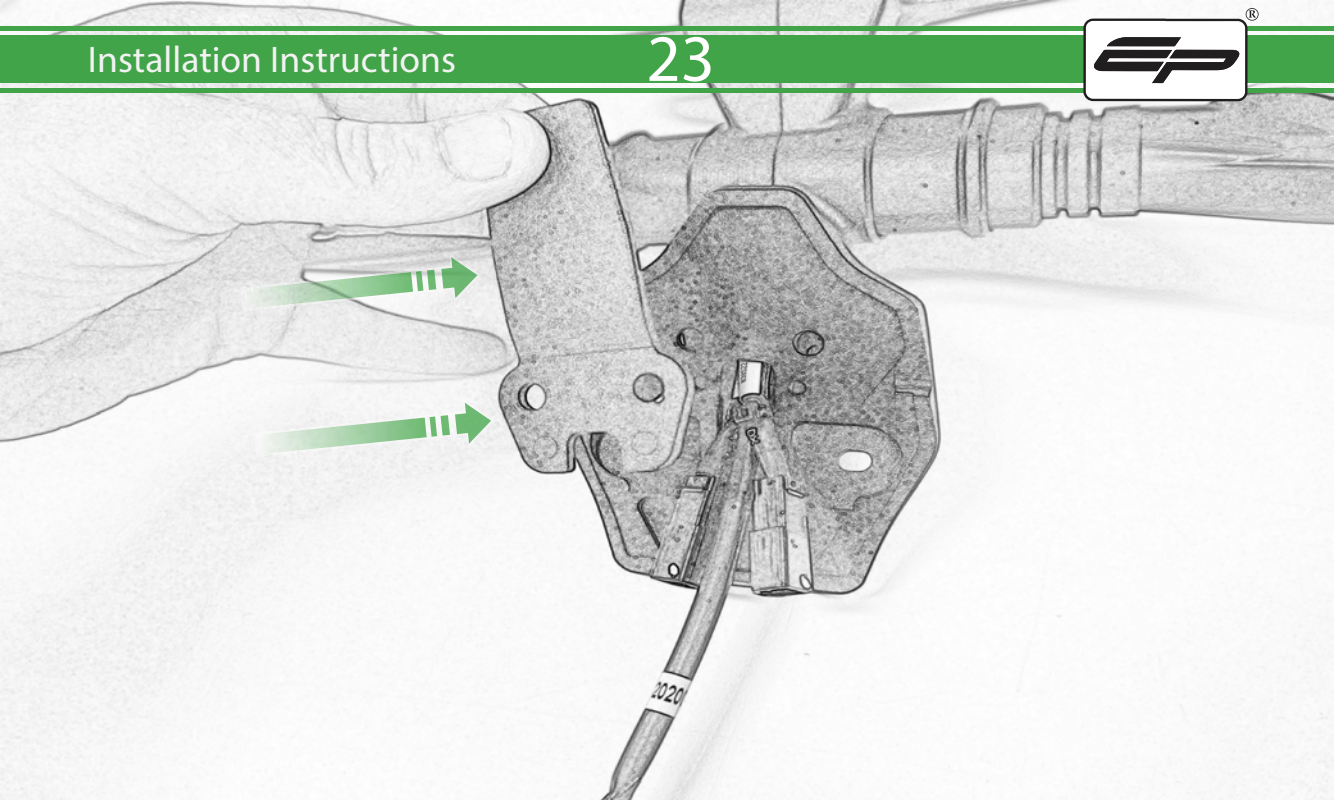



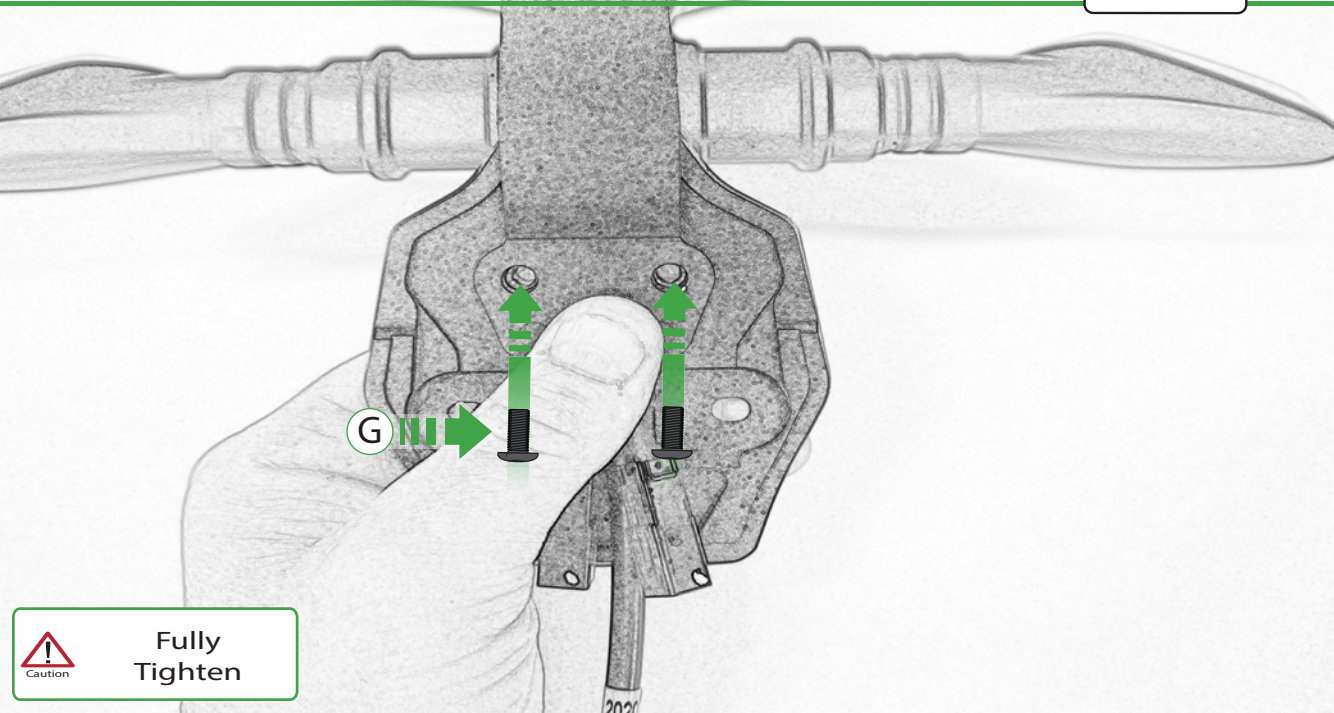

G



Caution

Fully  
Tighten

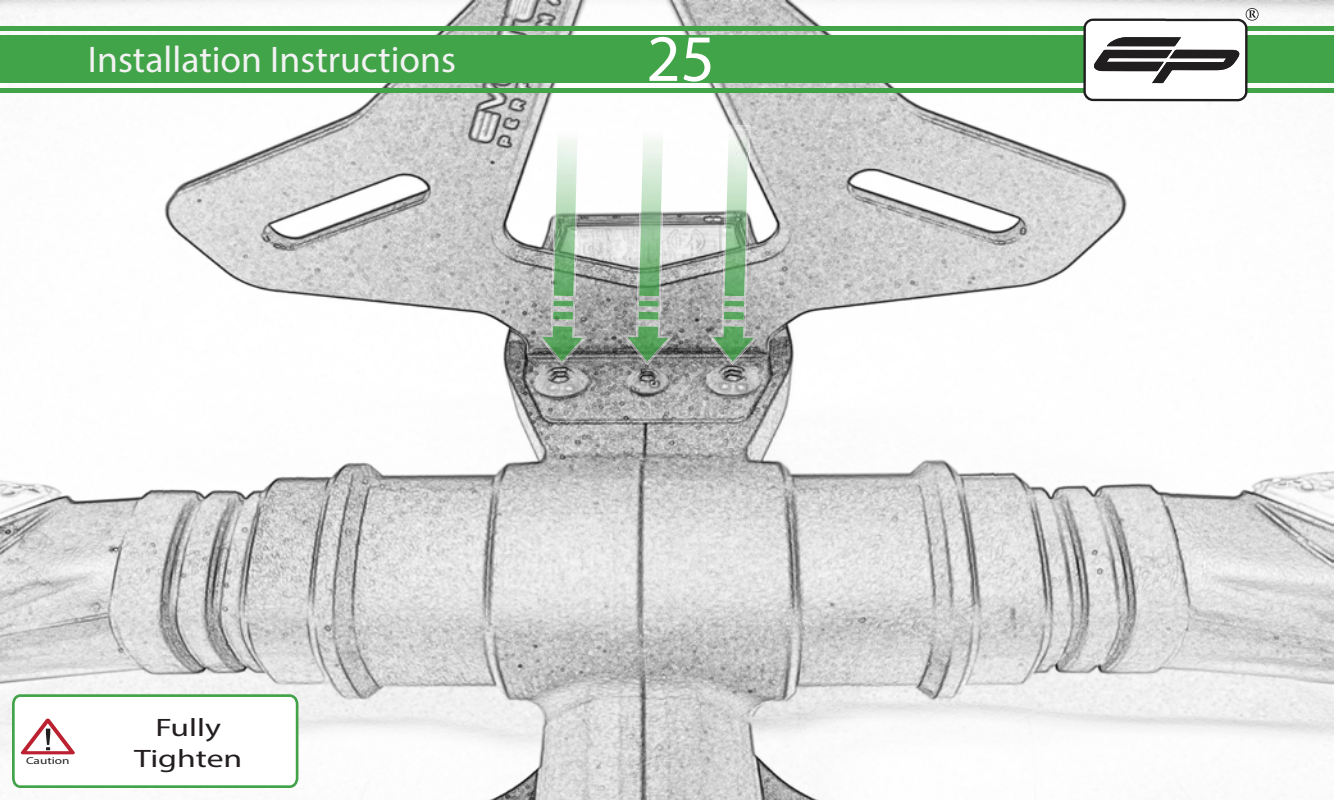

Caution

Fully  
Tighten

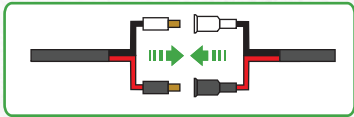
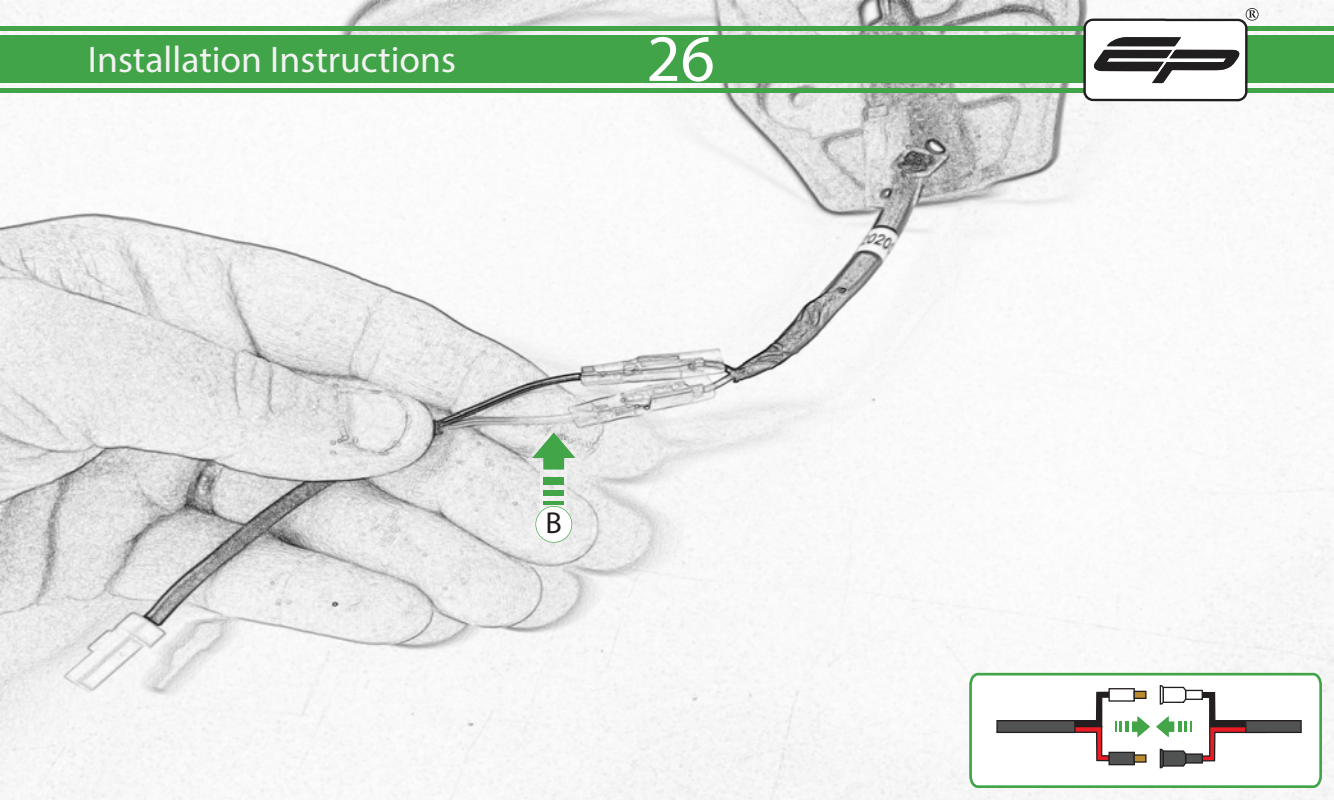

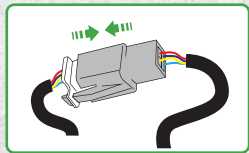
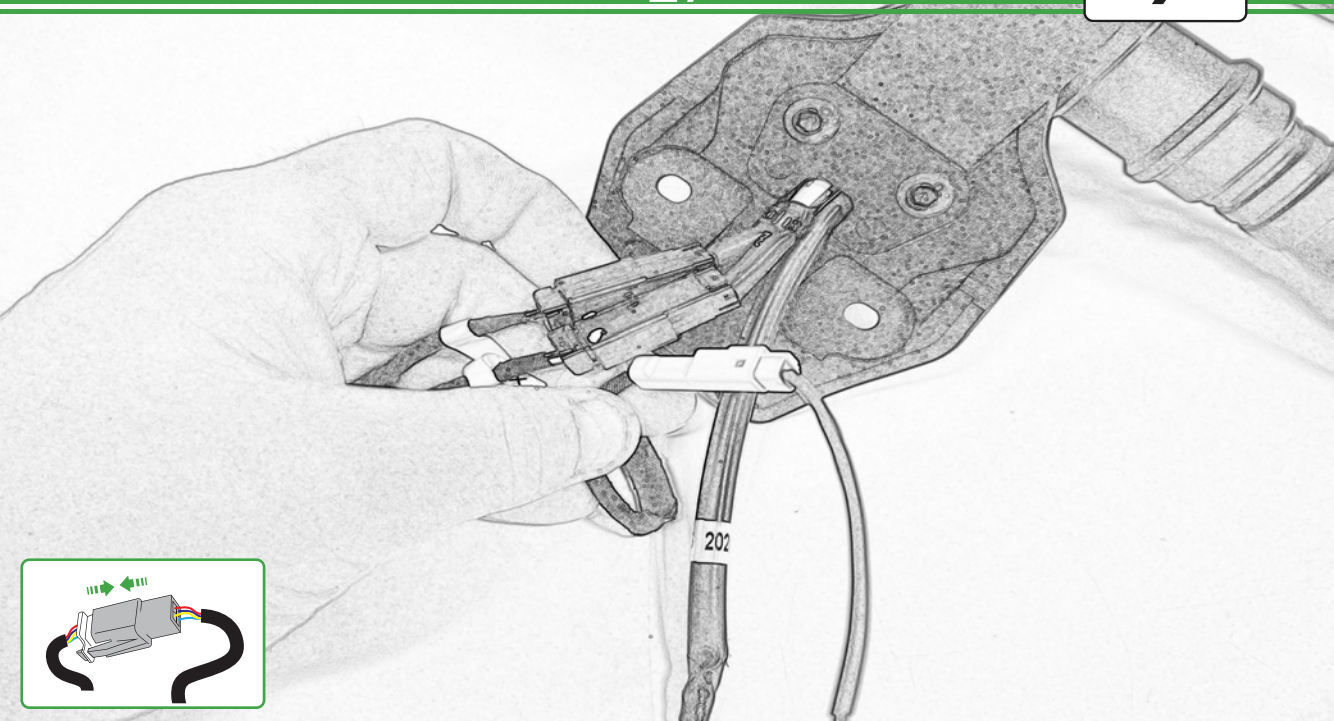

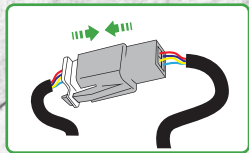
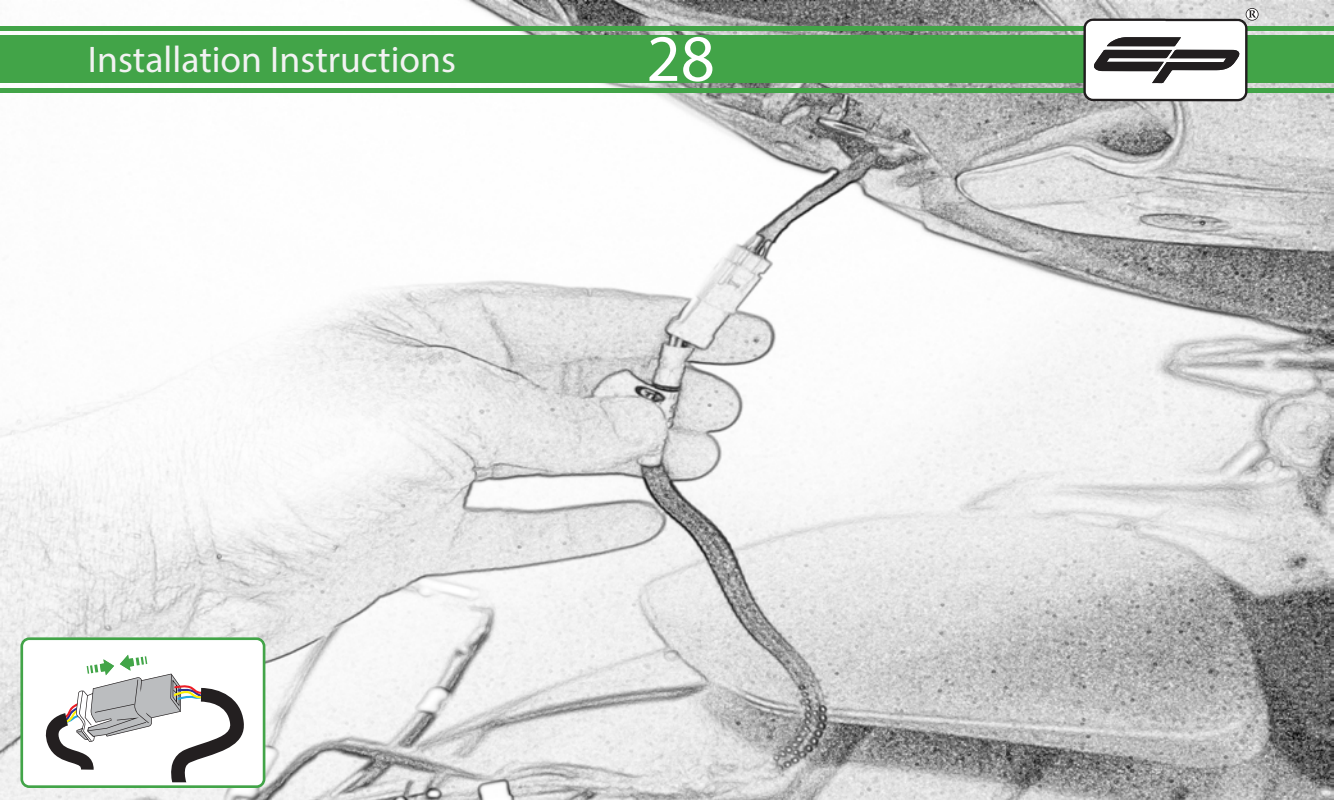



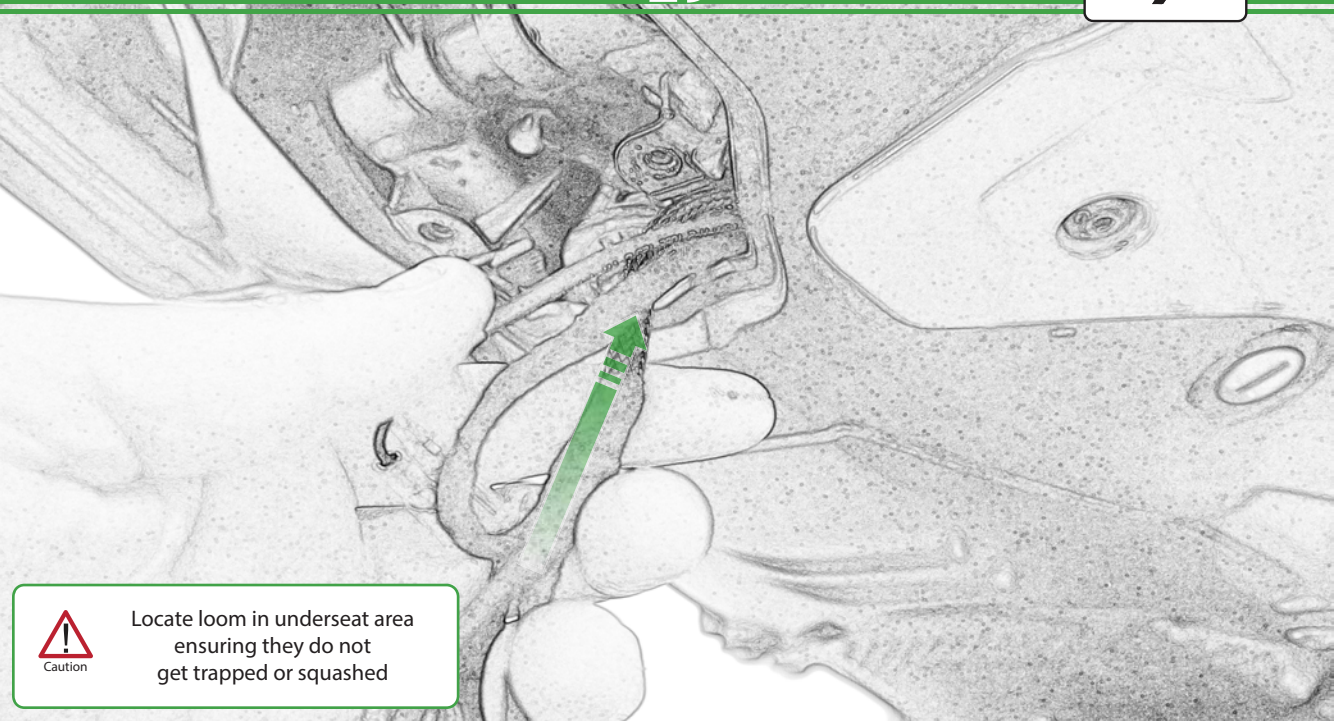

Caution

Locate loom in underseat area ensuring they do not get trapped or squashed

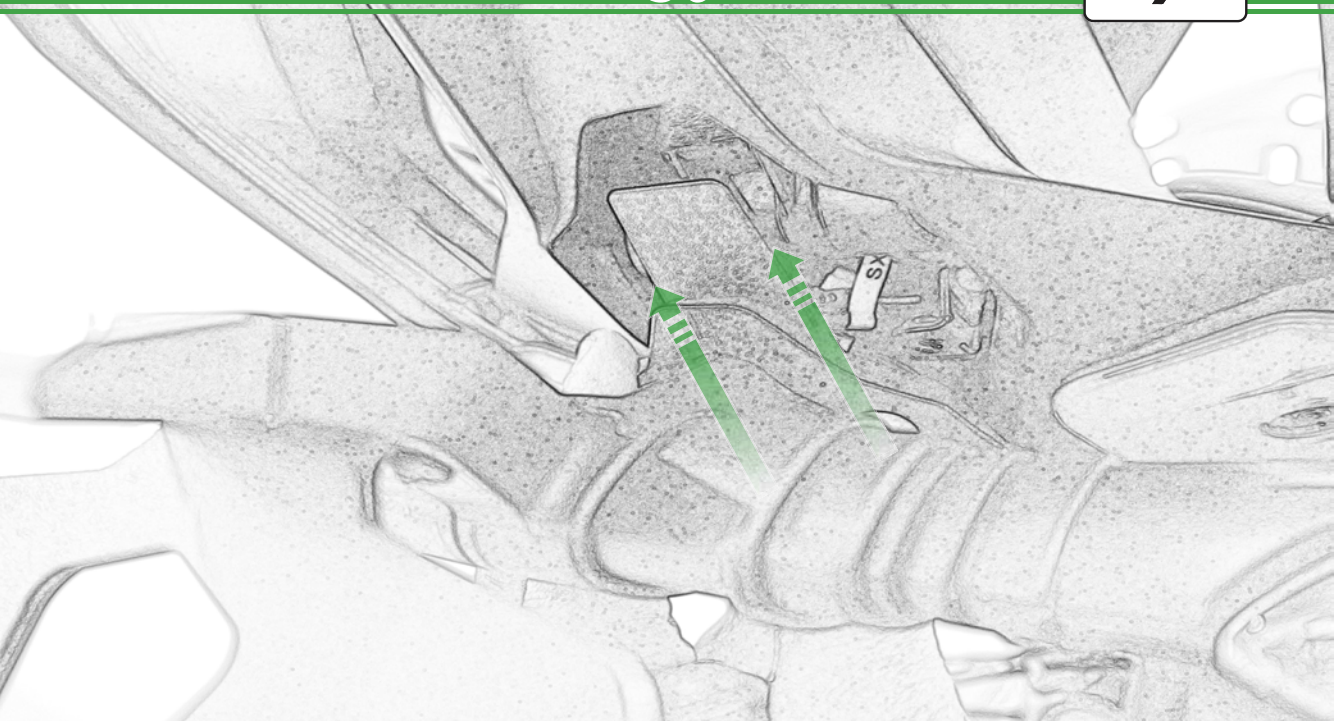



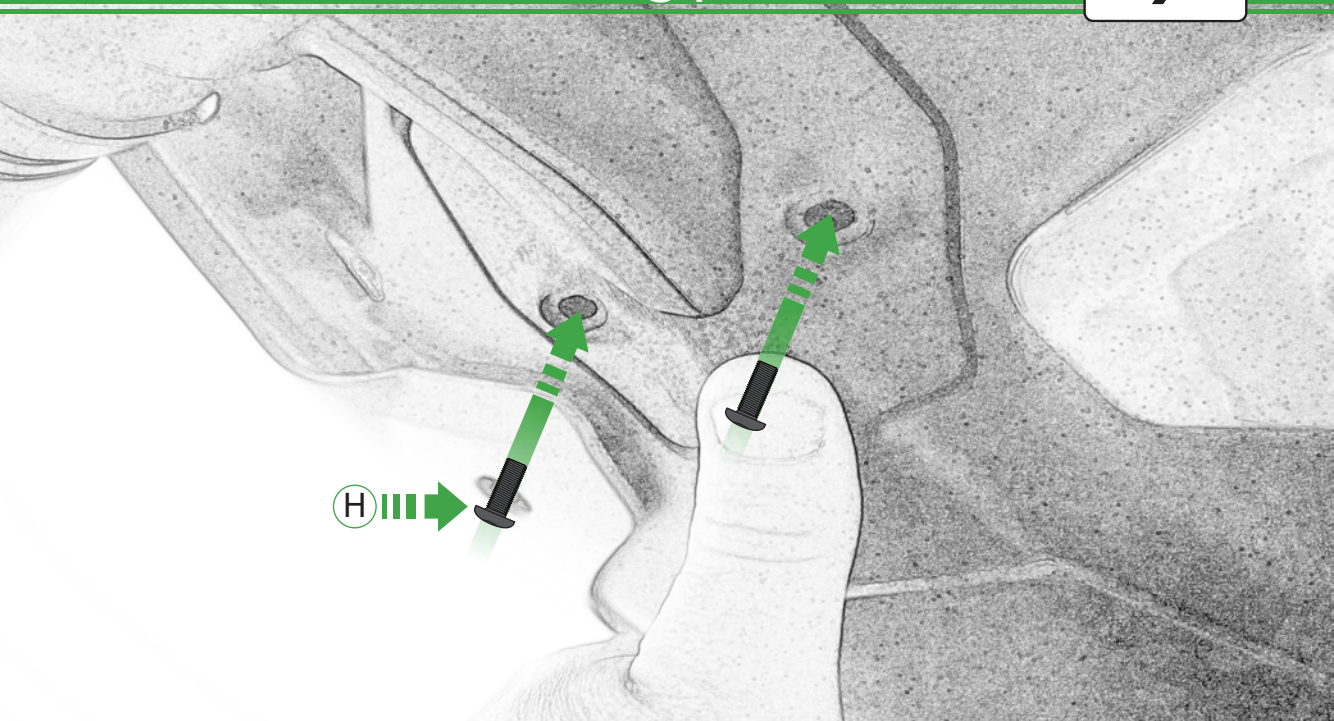

H

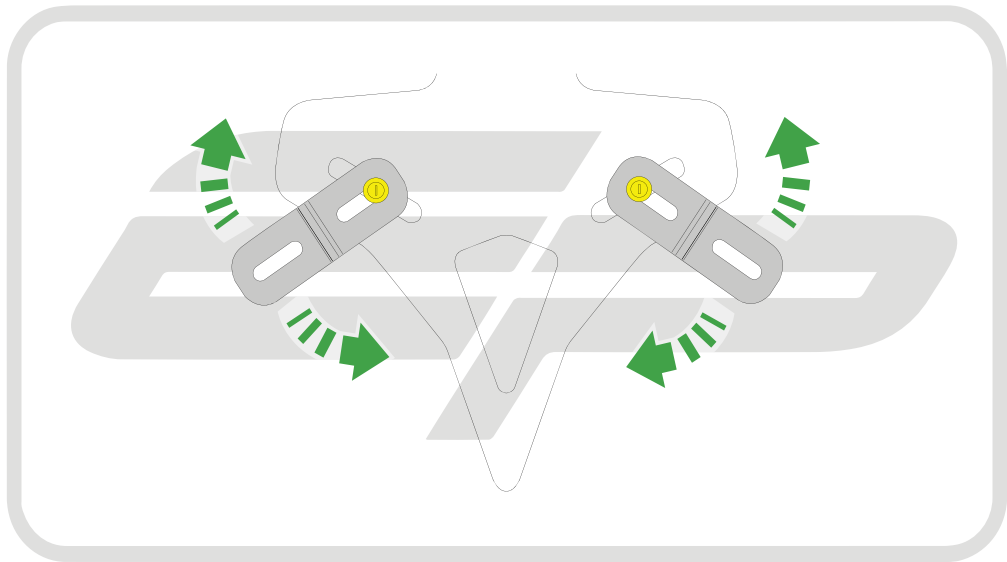

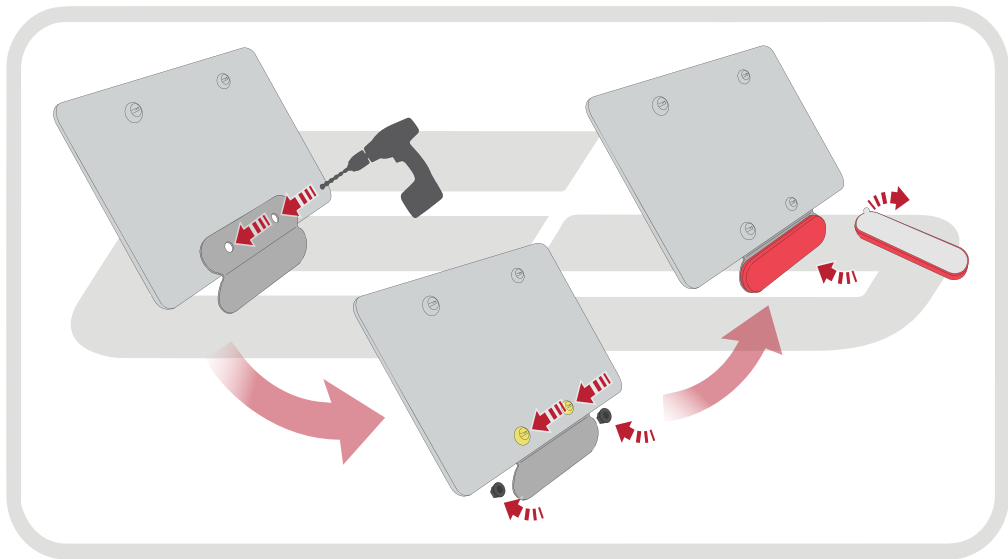

## **ESSENTIAL CHECKS**

After installation of your tail tidy ensure that the licence plate does not contact the rear tyre when suspension is fully compressed.

Ensure all electrics including indicators, tail light, brake light and licence plate light lights are working correctly before riding the motorcycle.

It is recommended that periodic inspections are made to ensure that all fixings are fully tightend.

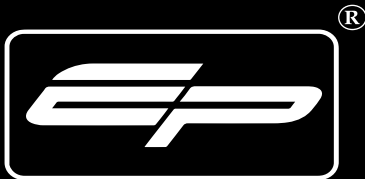

**EVOTECH**®  
P E R F O R M A N C E

[www.evotech-performance.com](http://www.evotech-performance.com)