



EVOTECH®
P E R F O R M A N C E

www.evotech-performance.com

Triumph Trident Tail Tidy
Installation Instructions



Kit Contents PRN015578

- (A) 1 x M8 x 20mm Button Head Bolt
- (B) 1 x M5 x 16mm Button Head Bolt
- (C) 1 x M5 Washer
- (D) 1 x Back Spacer
- (E) 1 x Front Spacer
- (F) 2 x M6 x 16 Black Button Head Bolt
- (G) 2 x M6 Flange Nut
- (H) 2 x M4 x 6 Black Button Head Bolt
- (I) 2 x P-Clip (No.2)
- (J) 4 x Undertray Spacer
- (K) 4 x Grub Screw
- (L) 4 x M5 x 35 Black Button Head Bolt
- (M) 6 x M4 x 8 Black Button Head Bolt

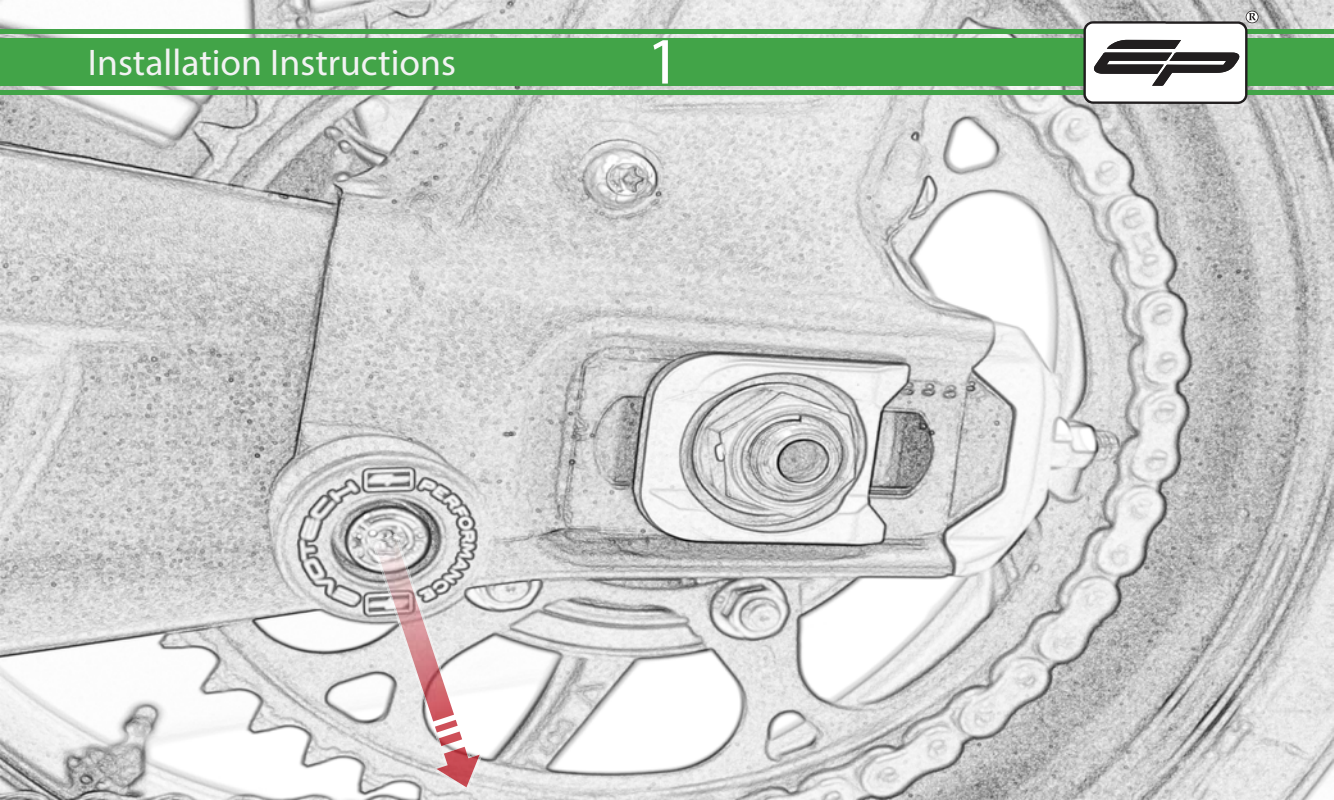

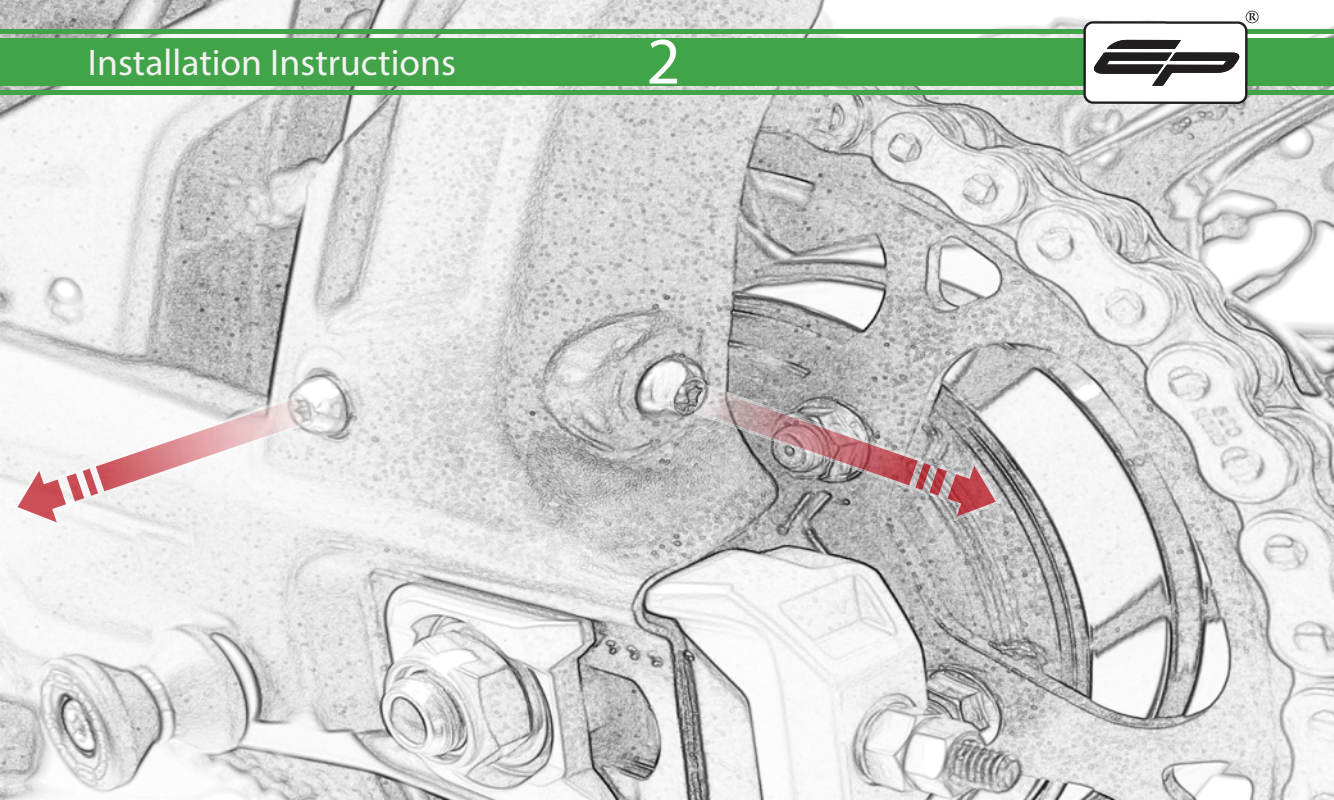



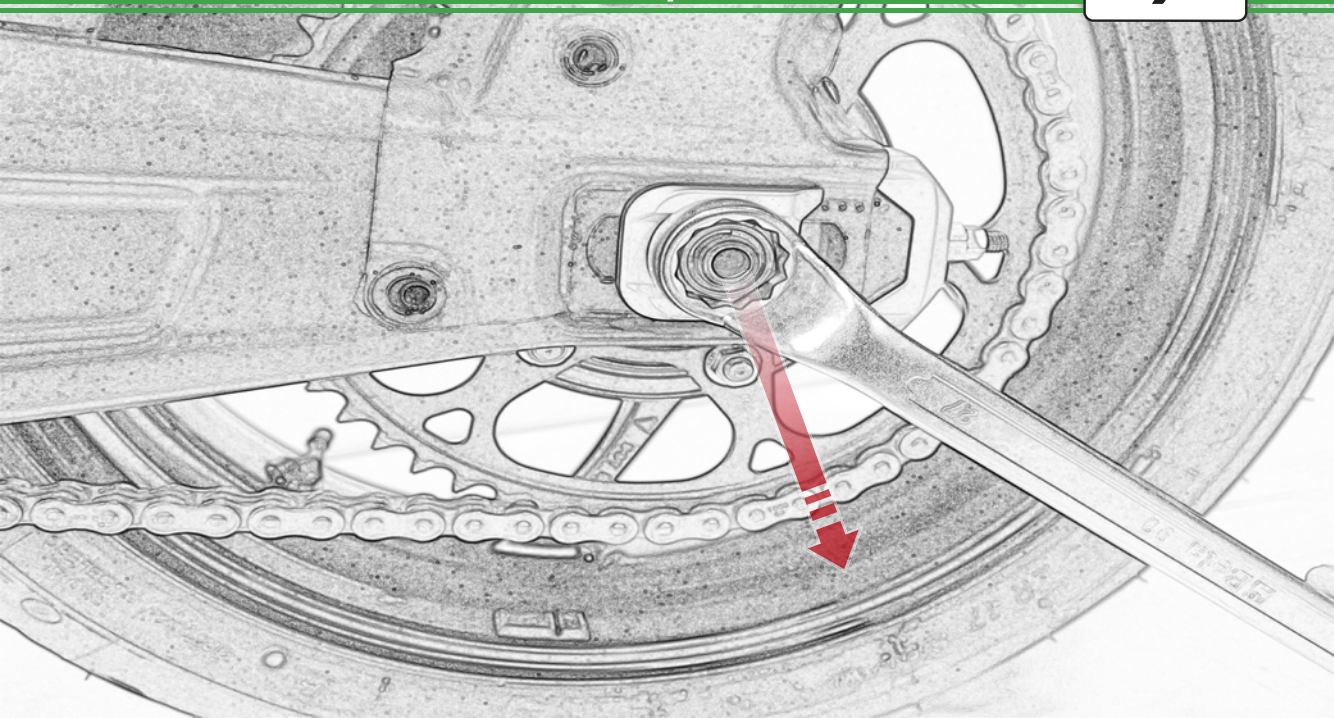

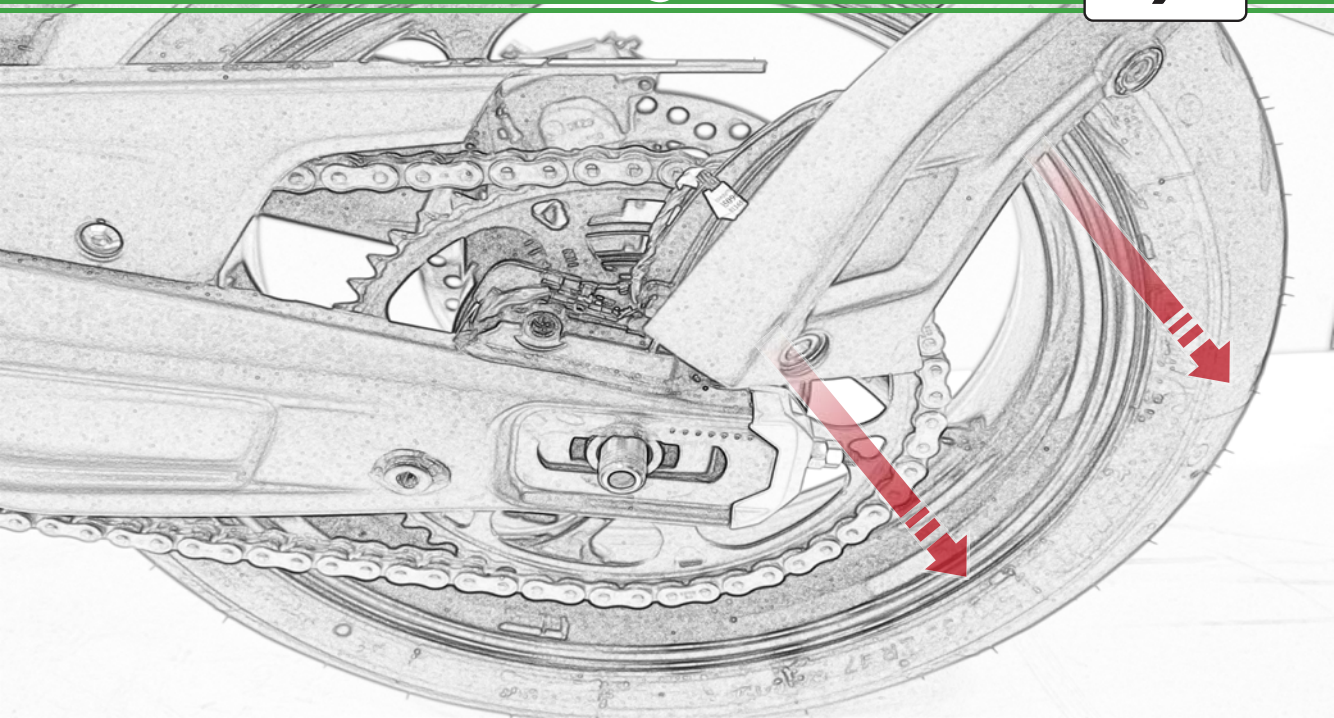

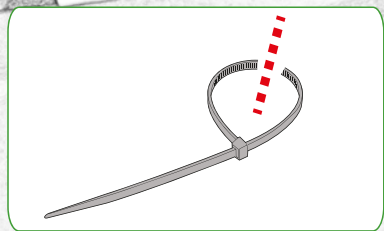
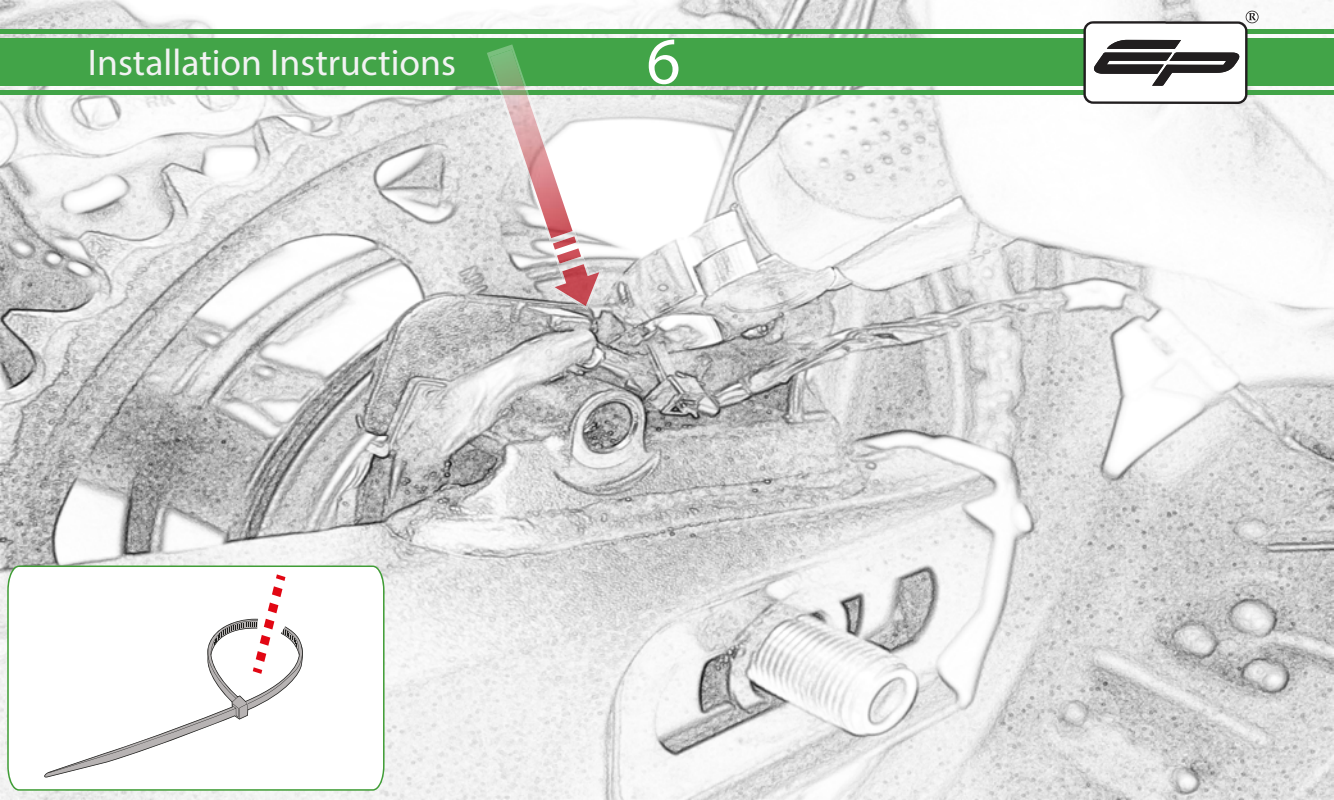

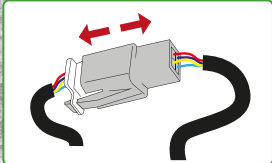
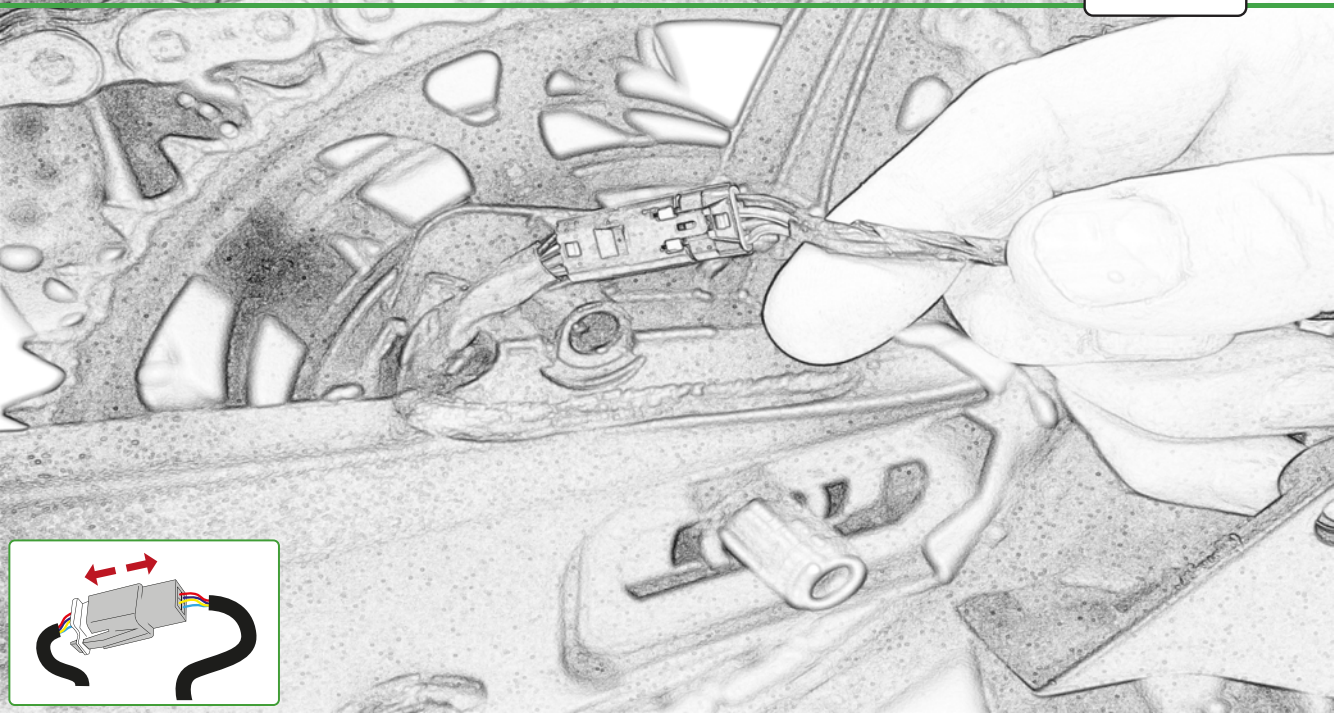

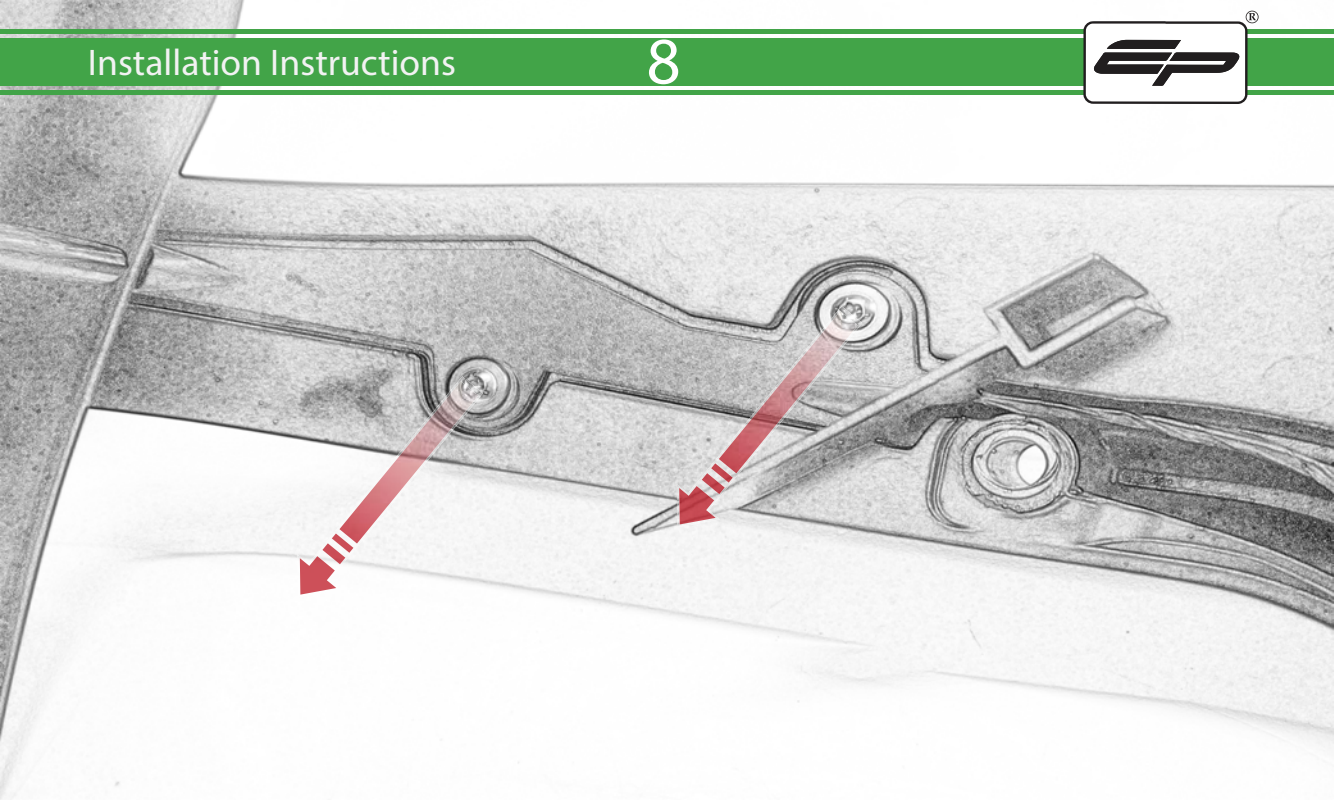

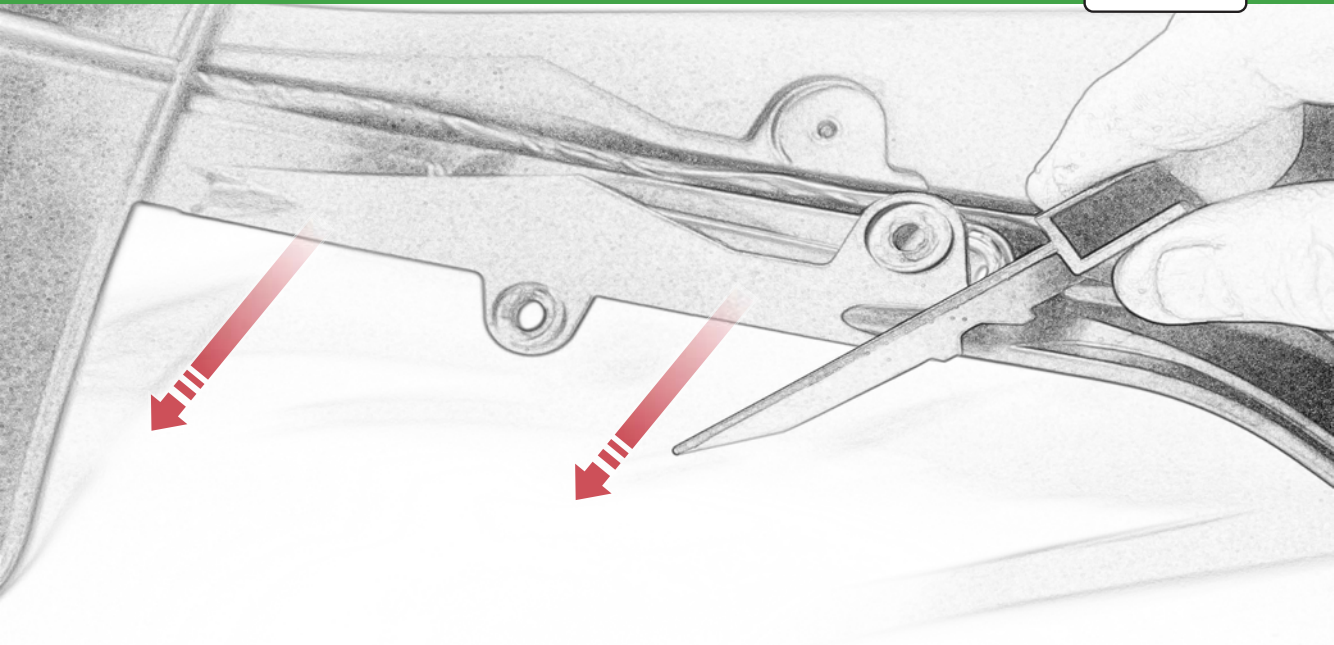

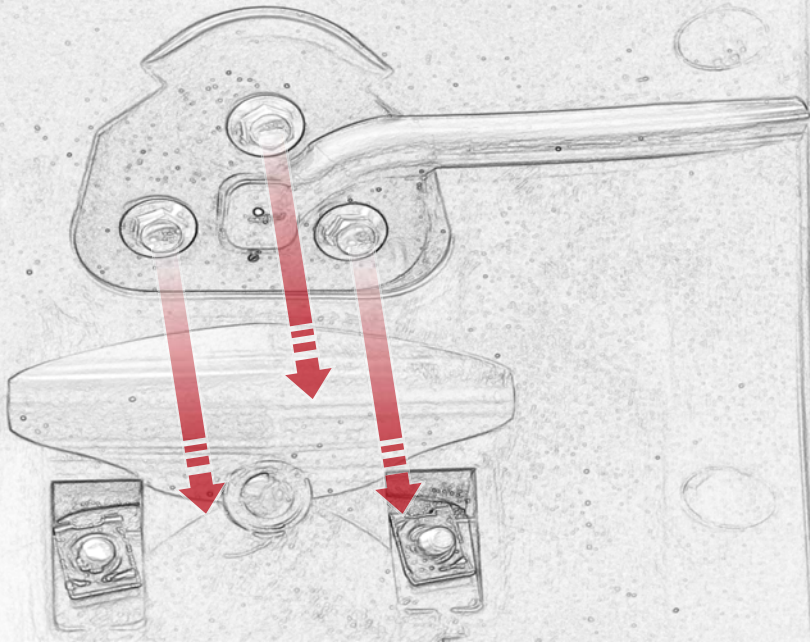

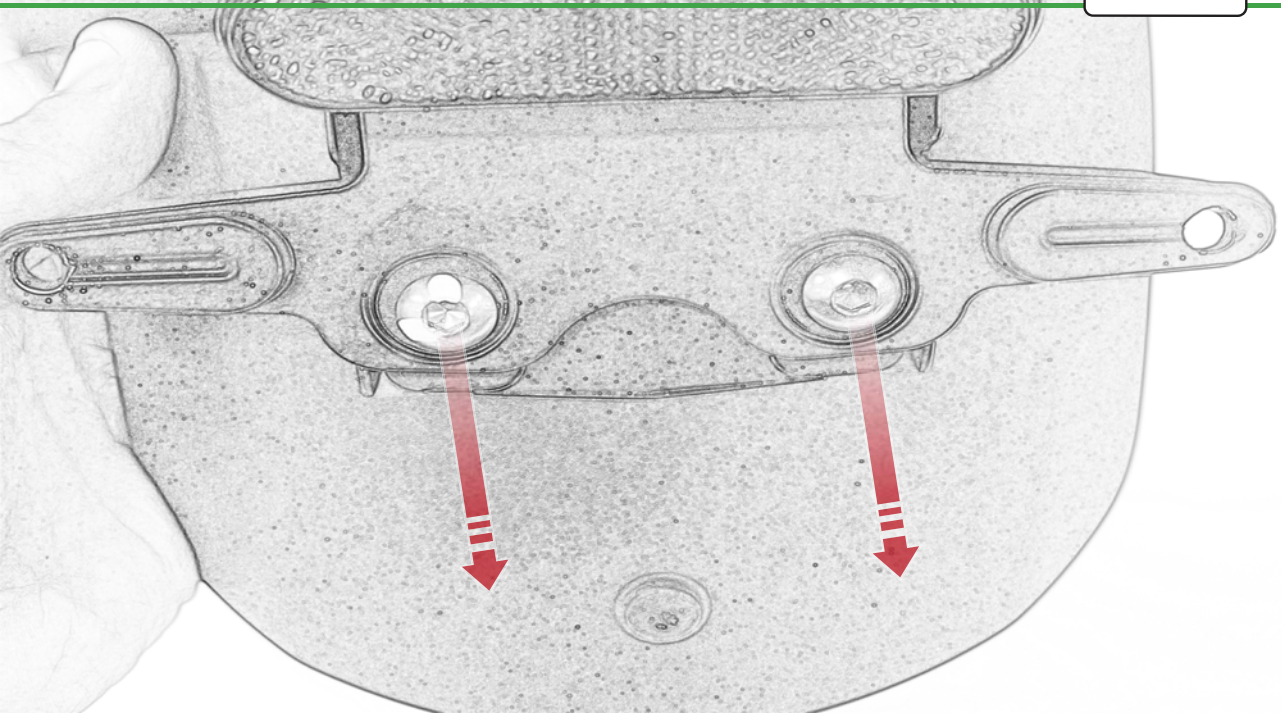

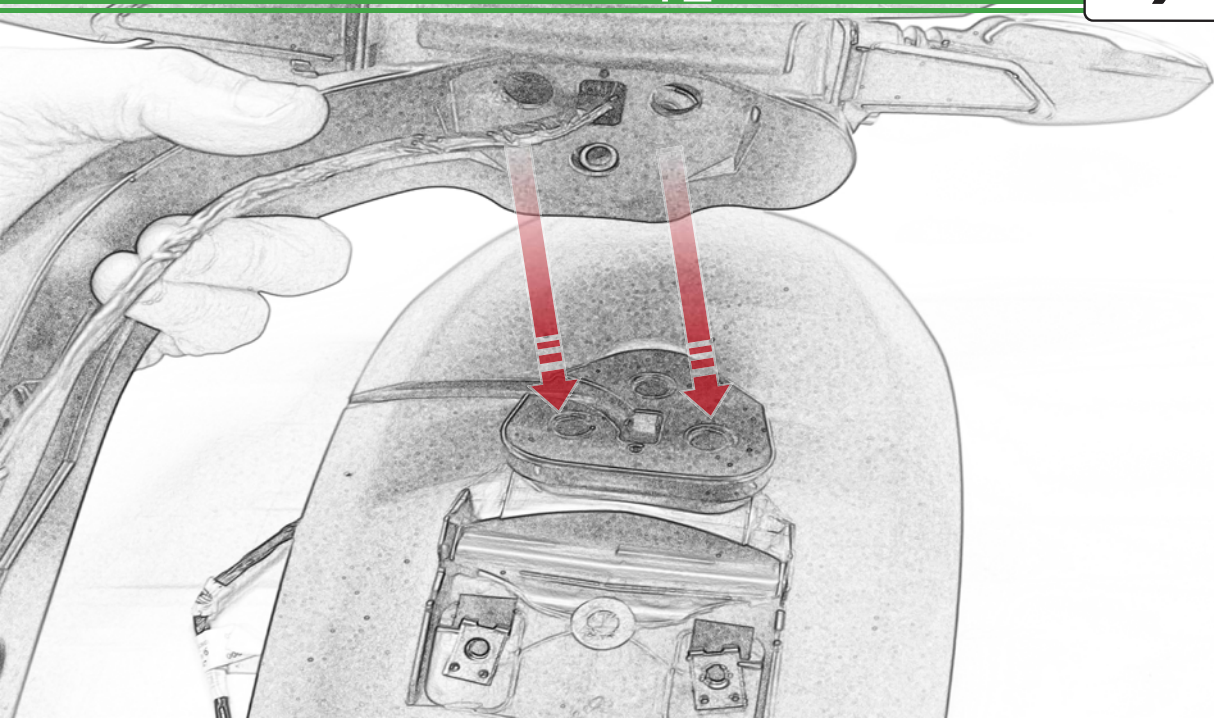

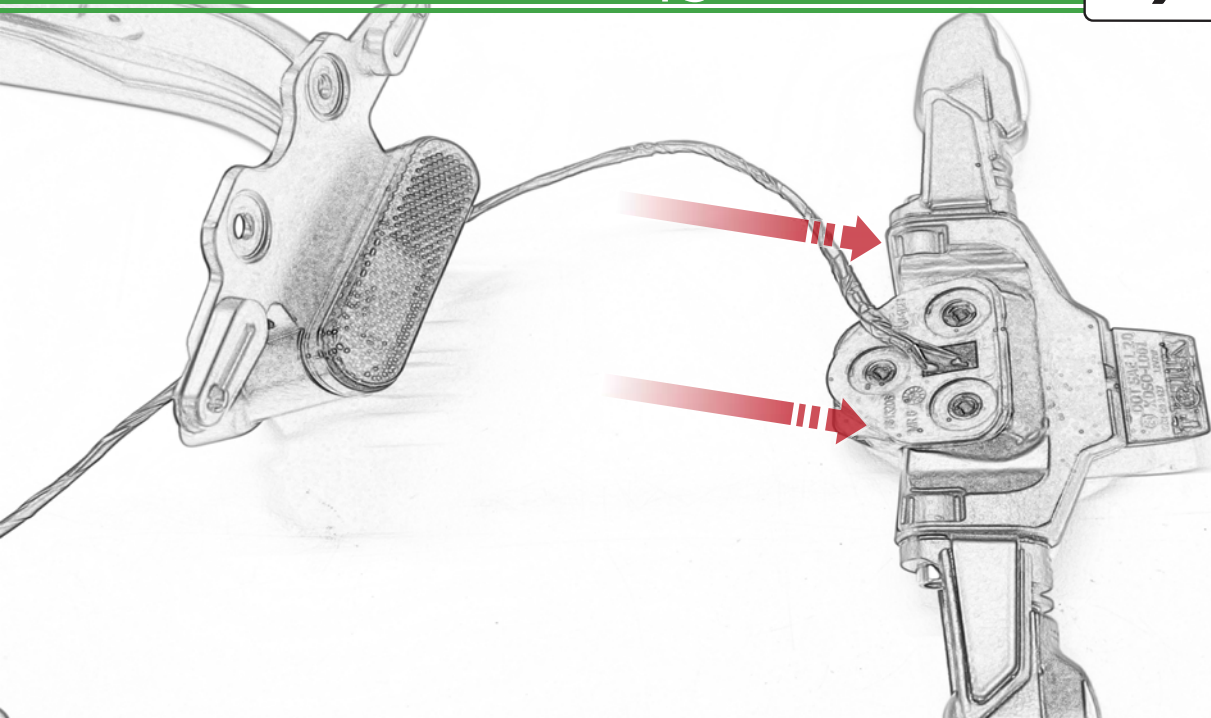

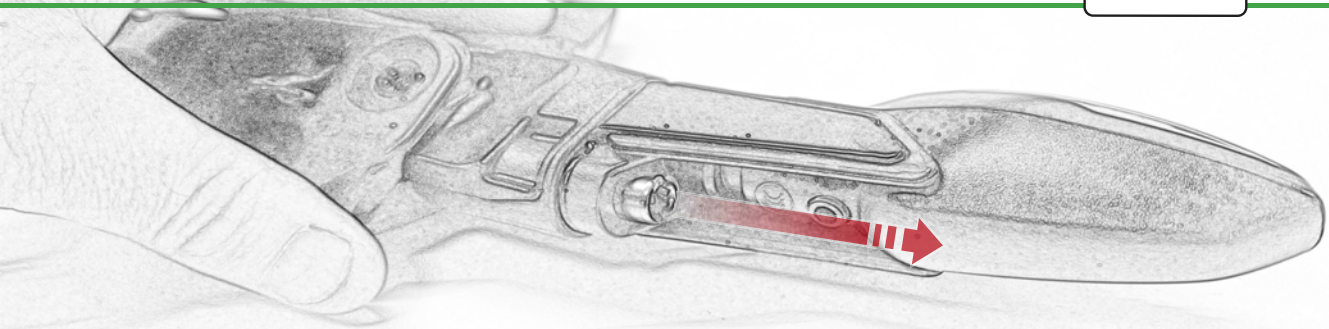

Repeat
Both Sides

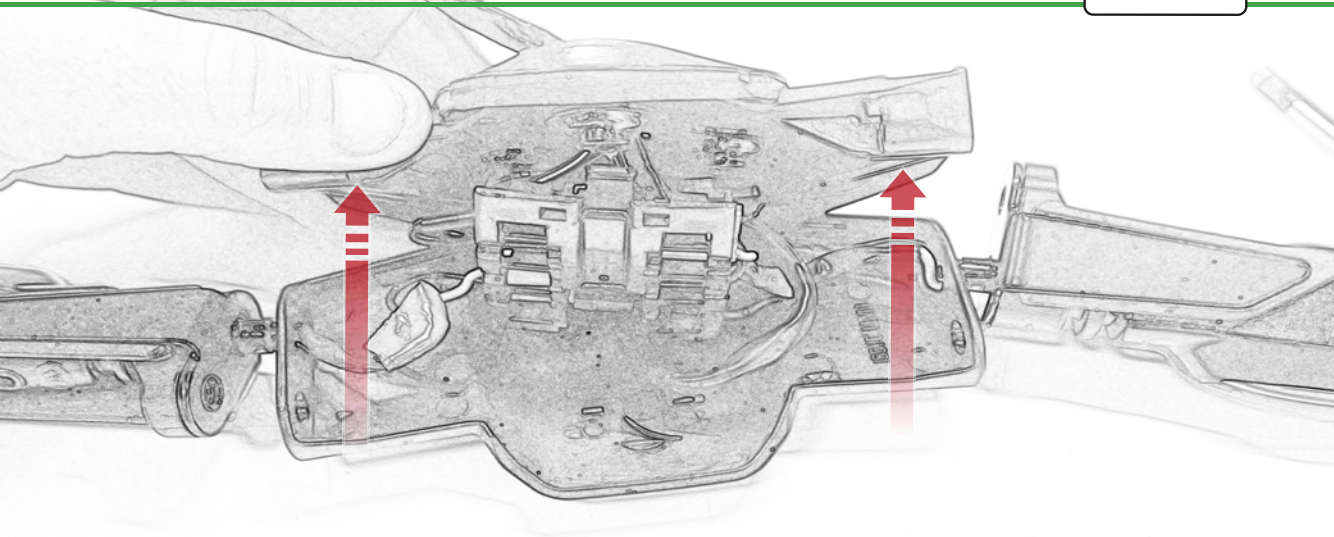

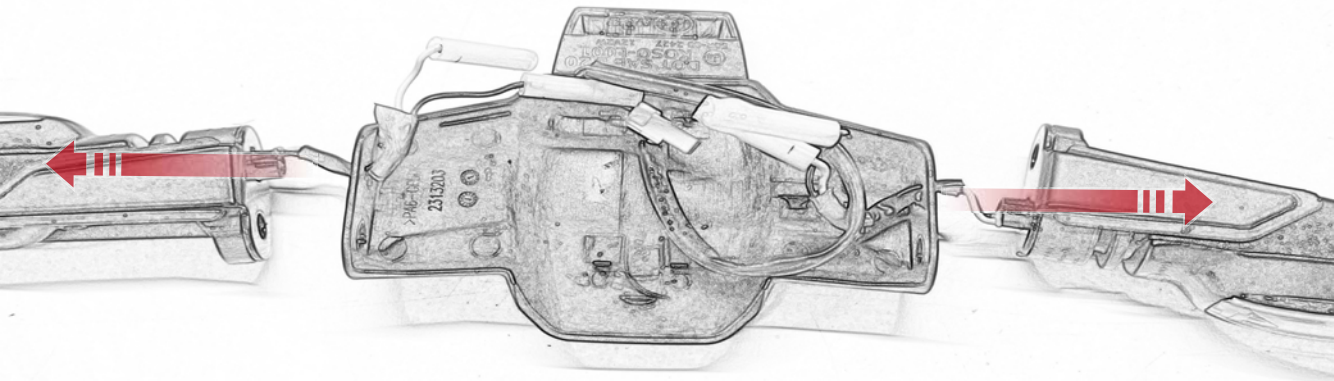

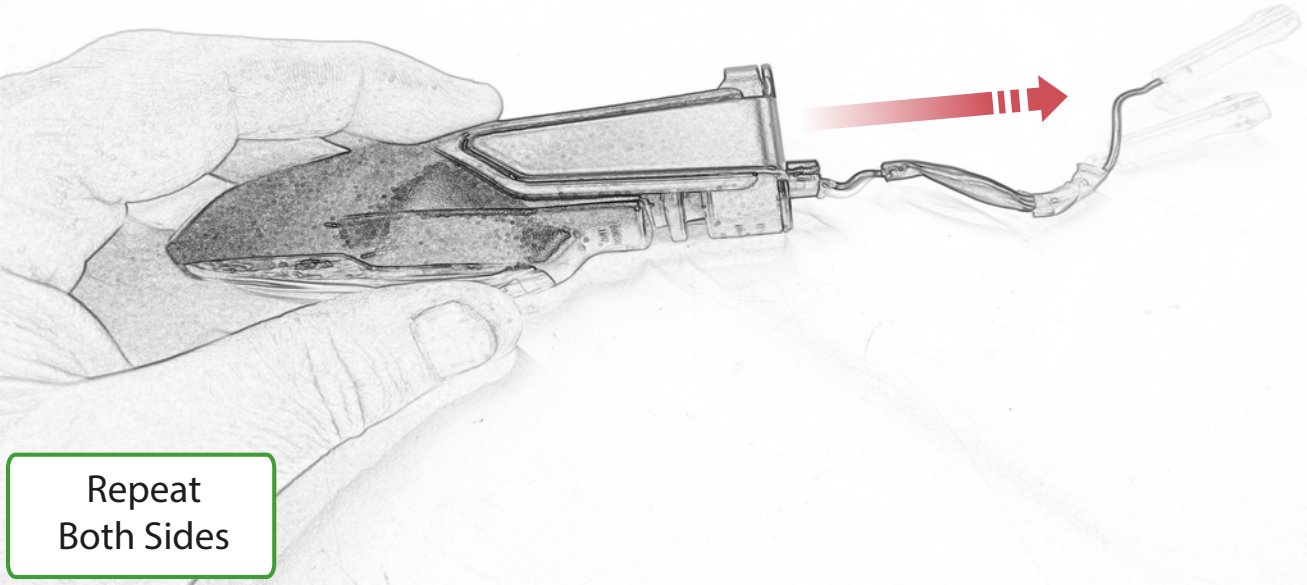

Repeat
Both Sides

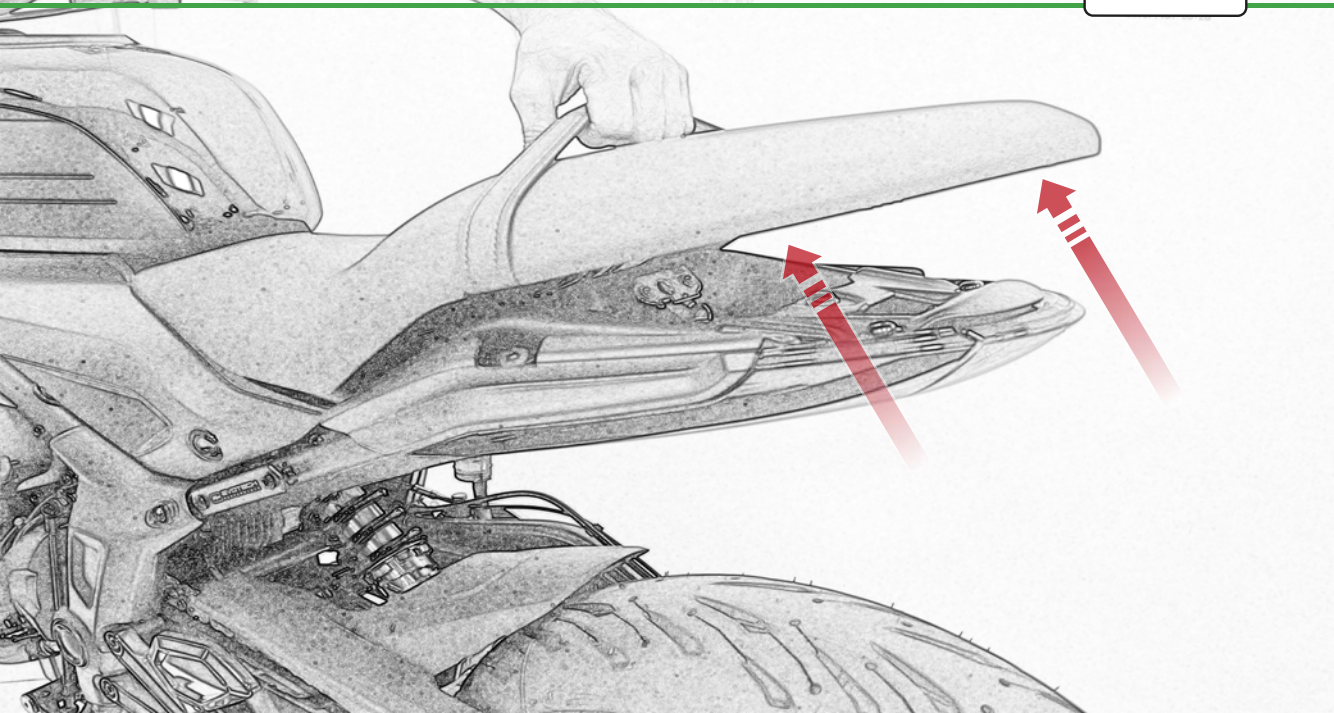

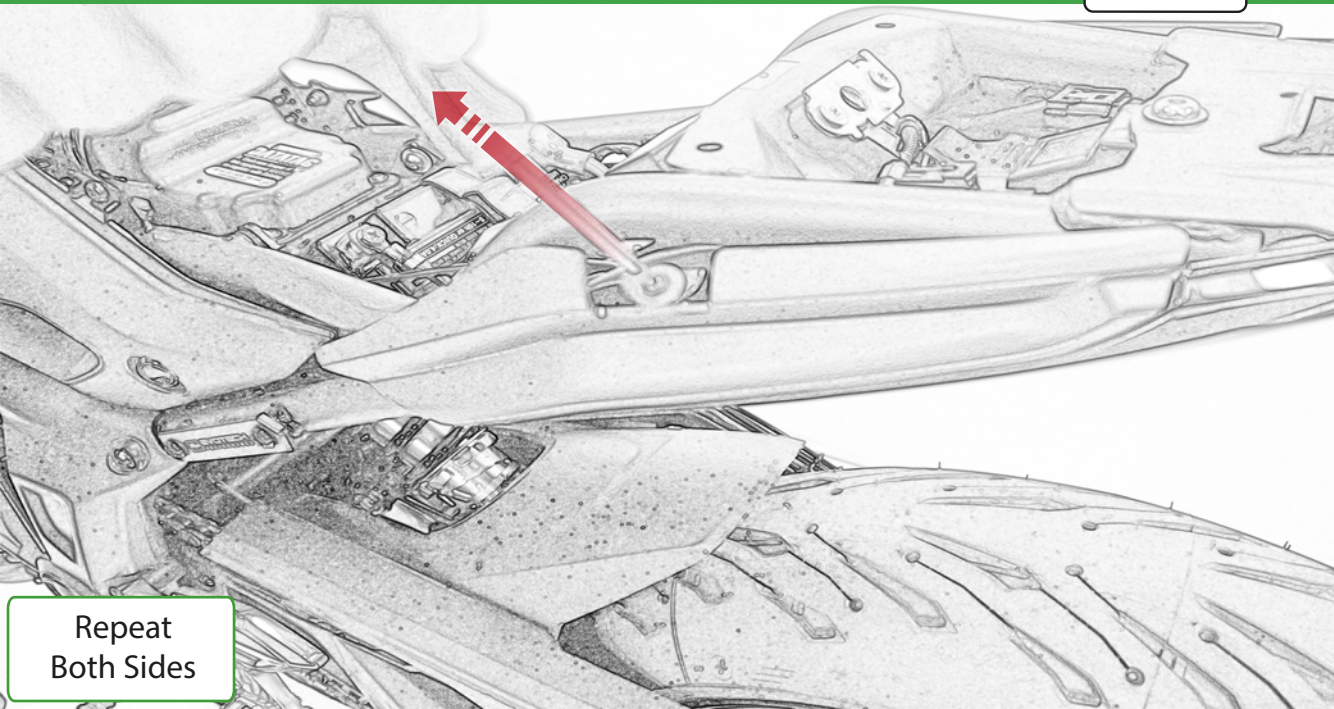

Repeat
Both Sides

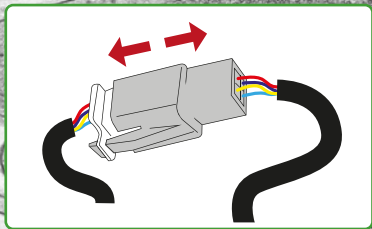
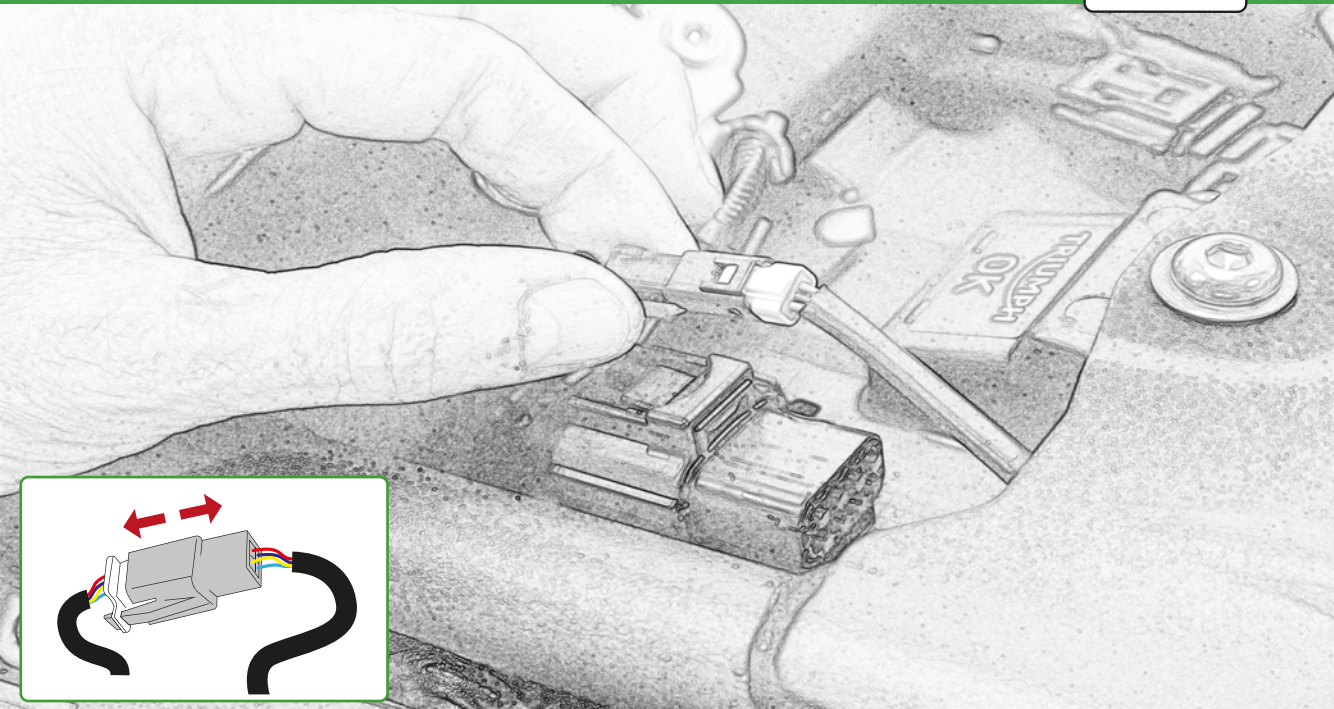

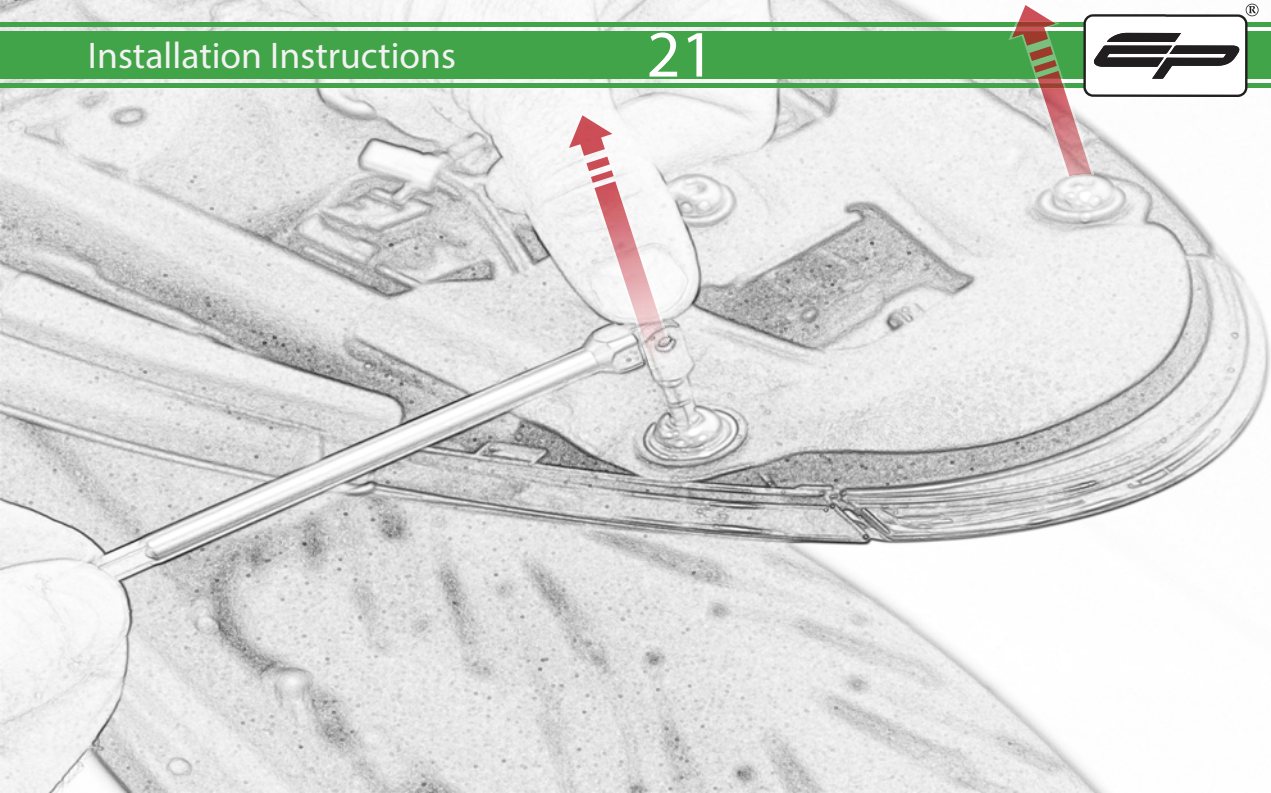

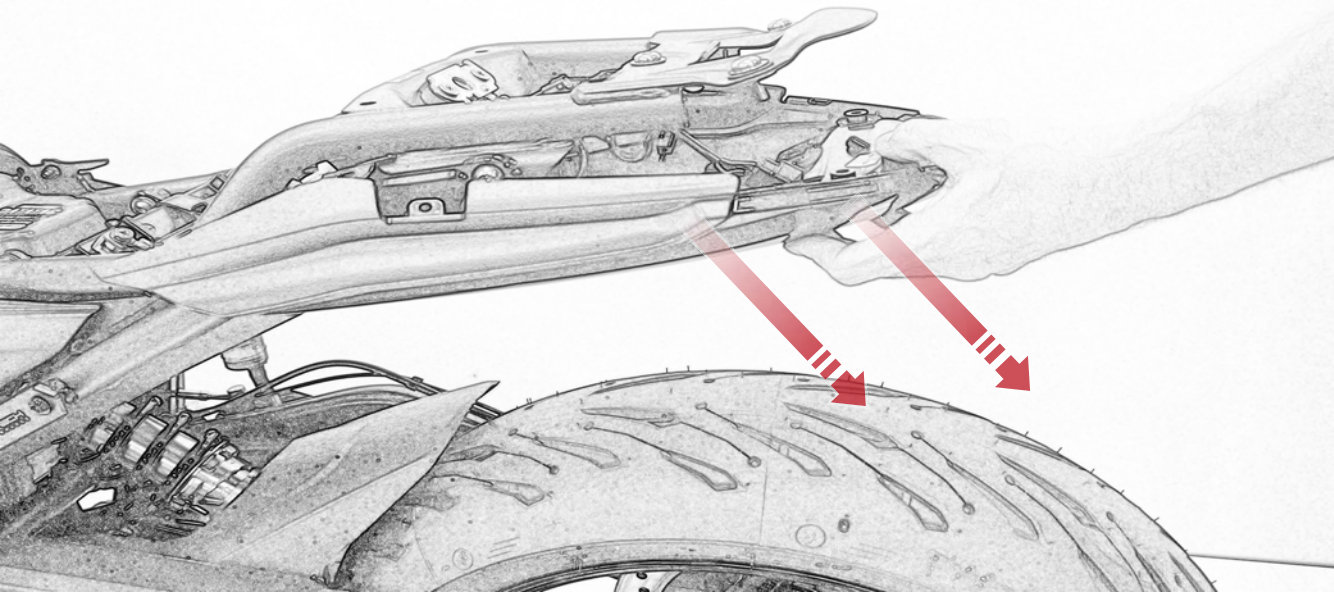

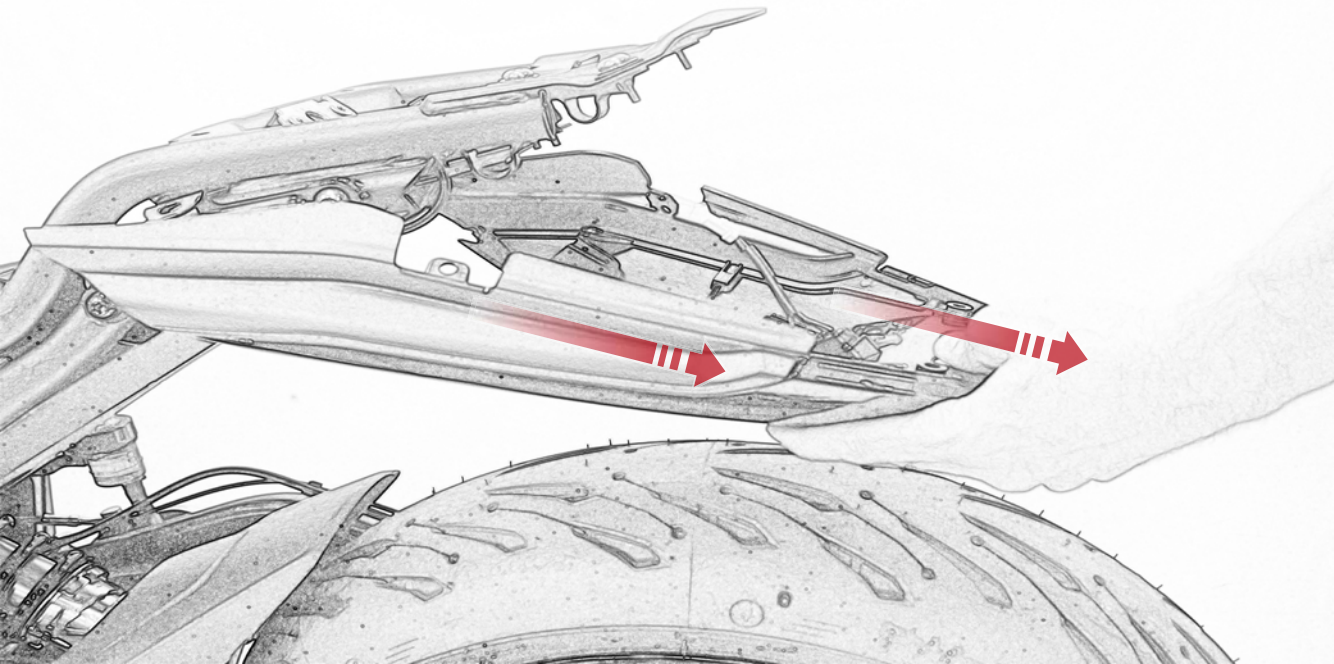



Release
Tab

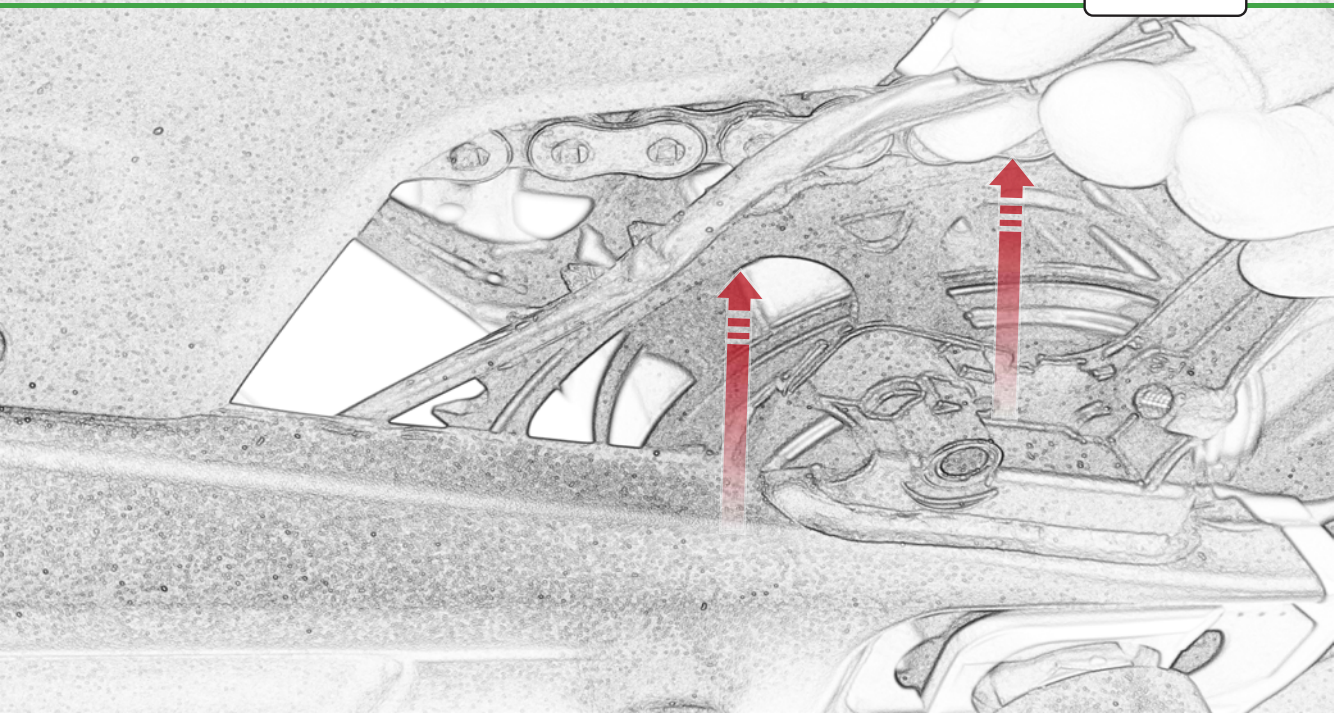

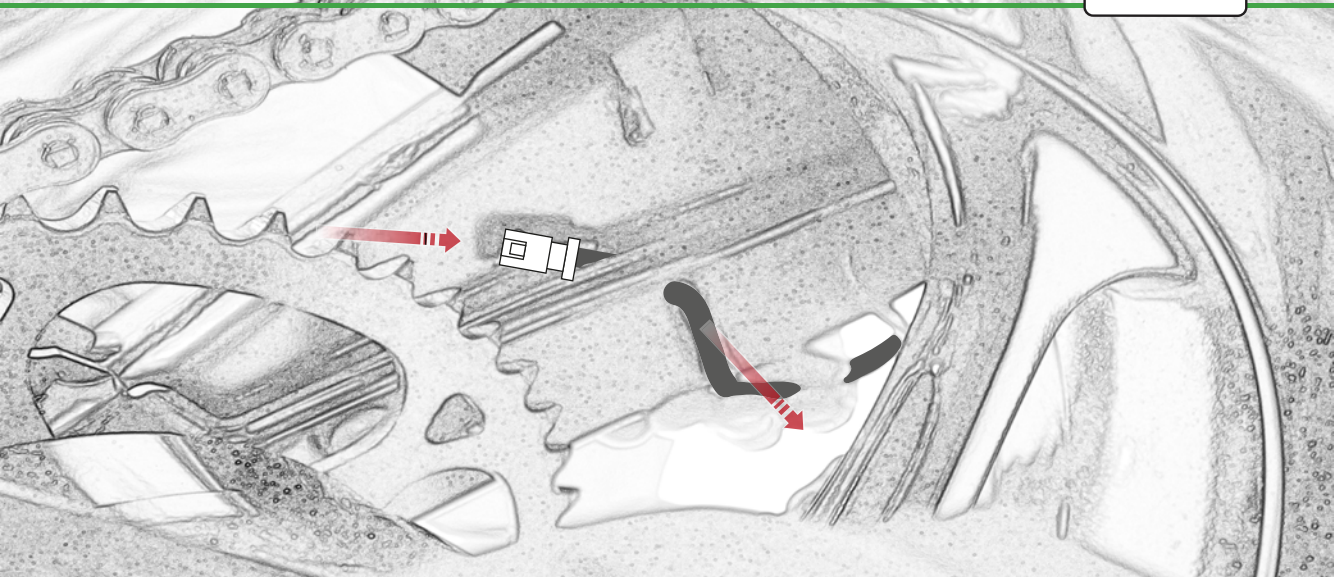

**Thread Wire
Behind Cover**

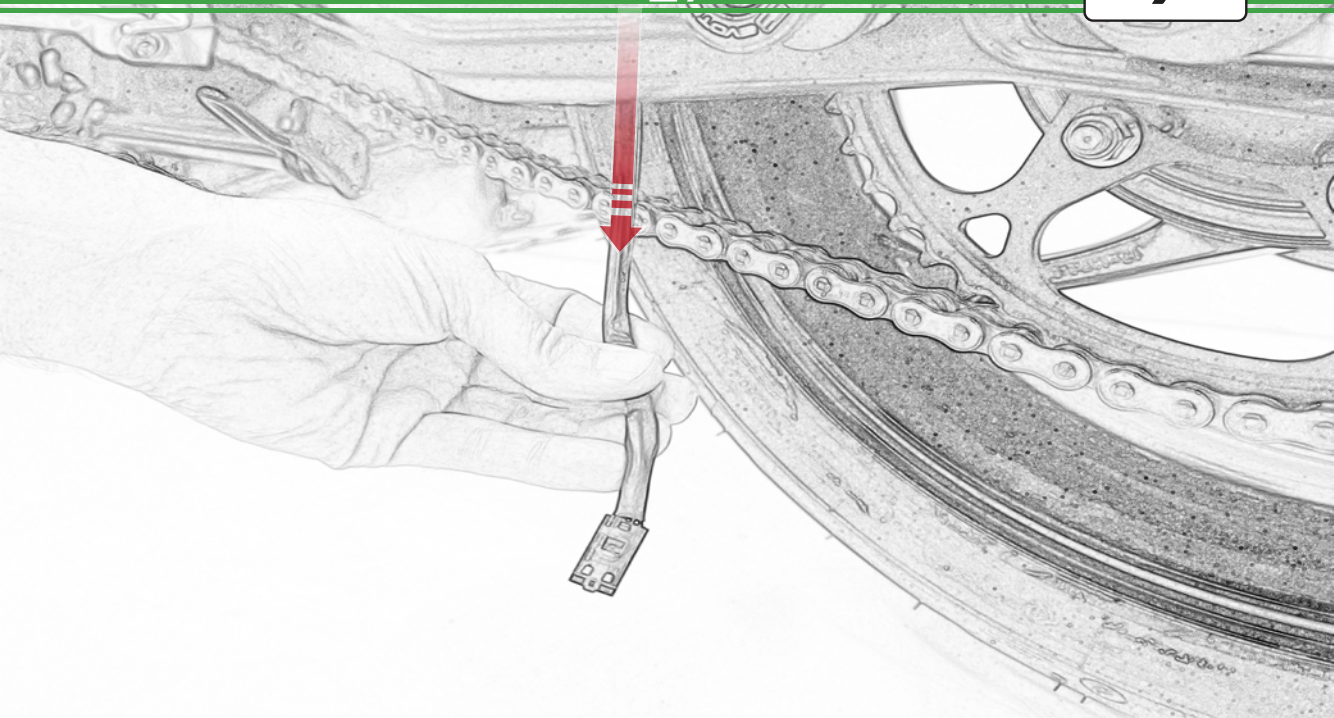

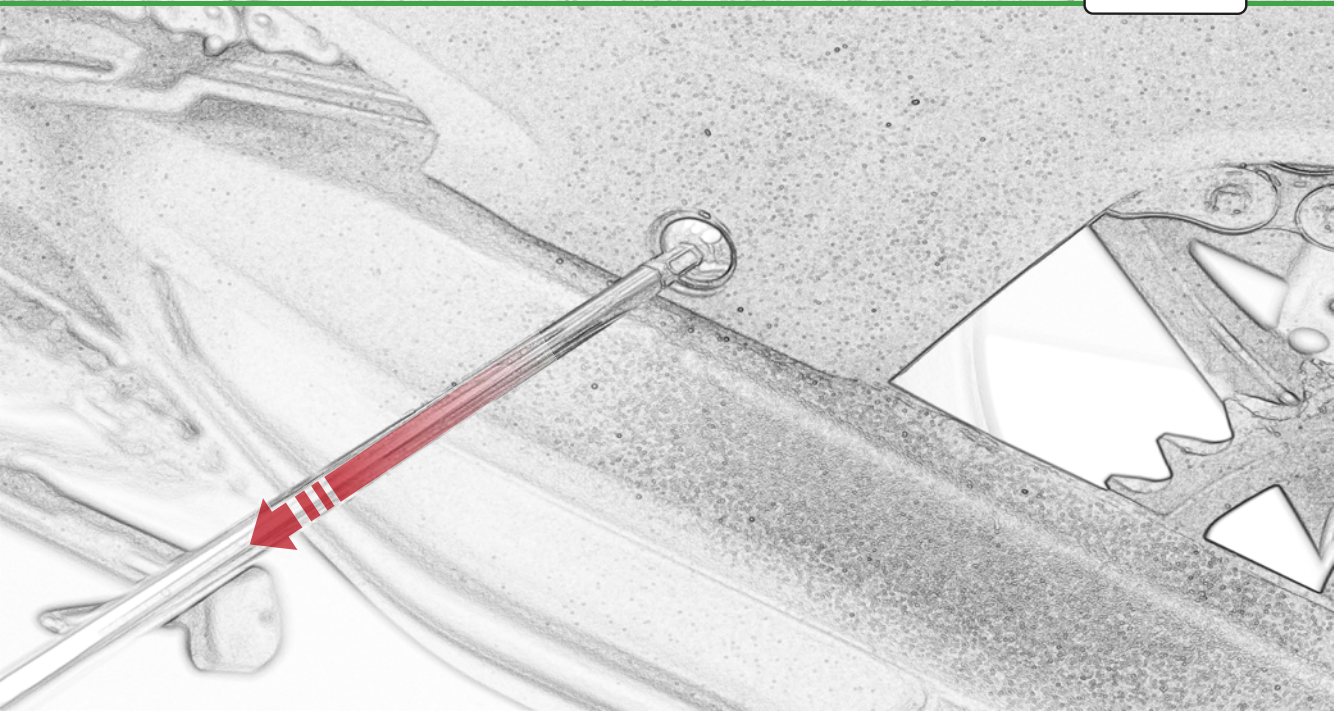

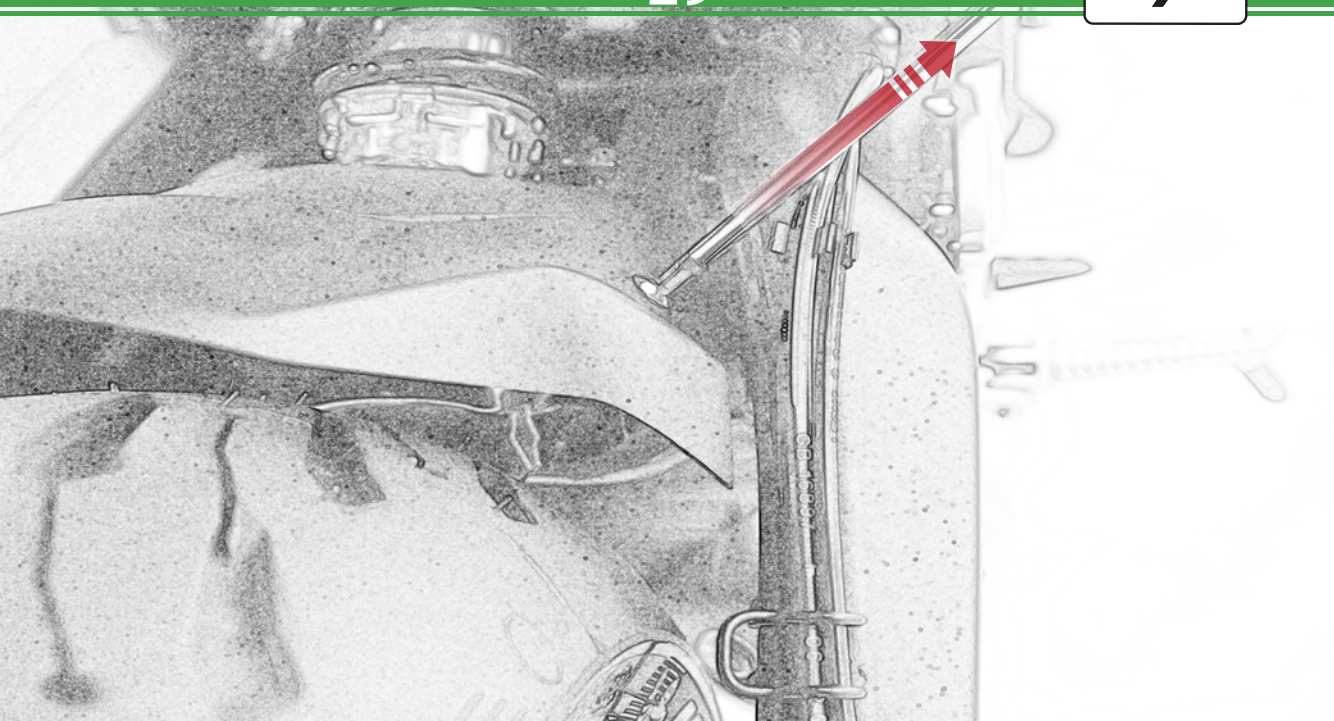

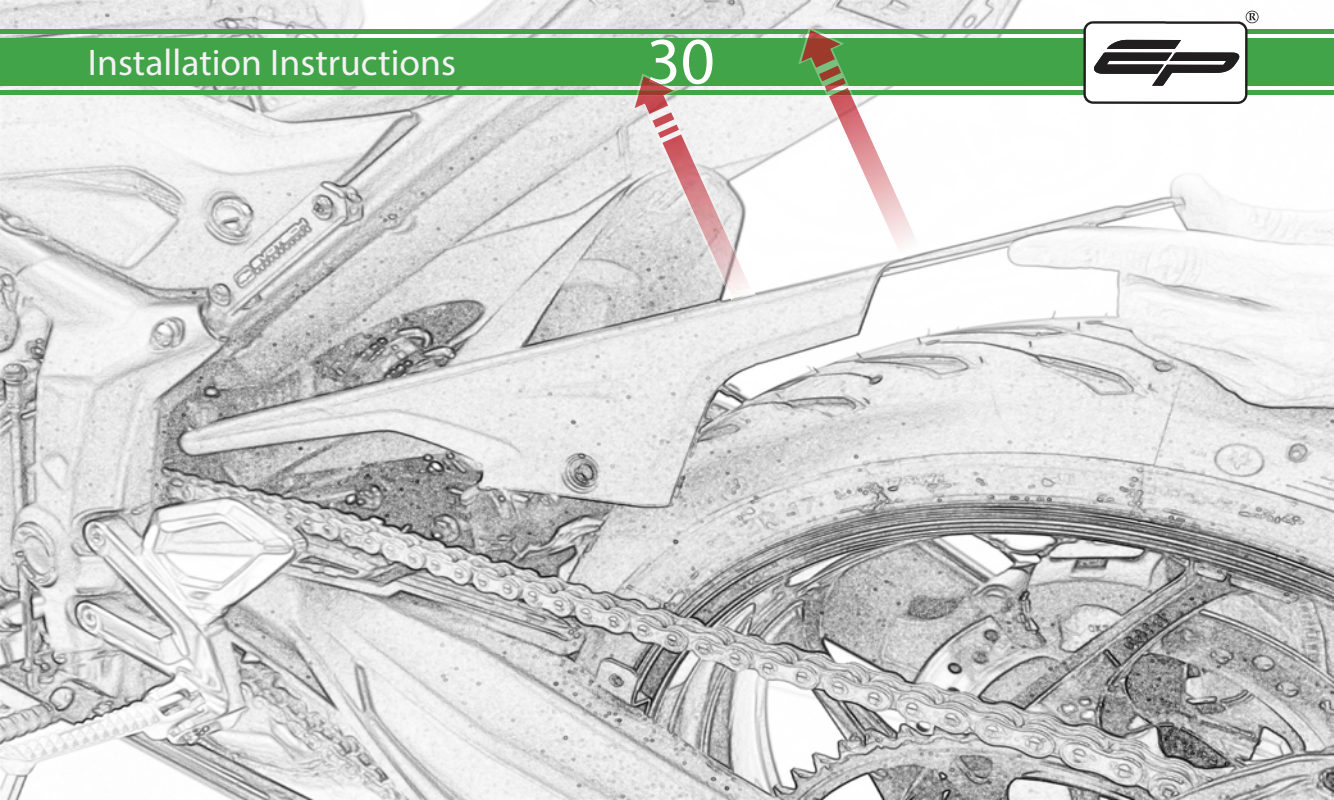

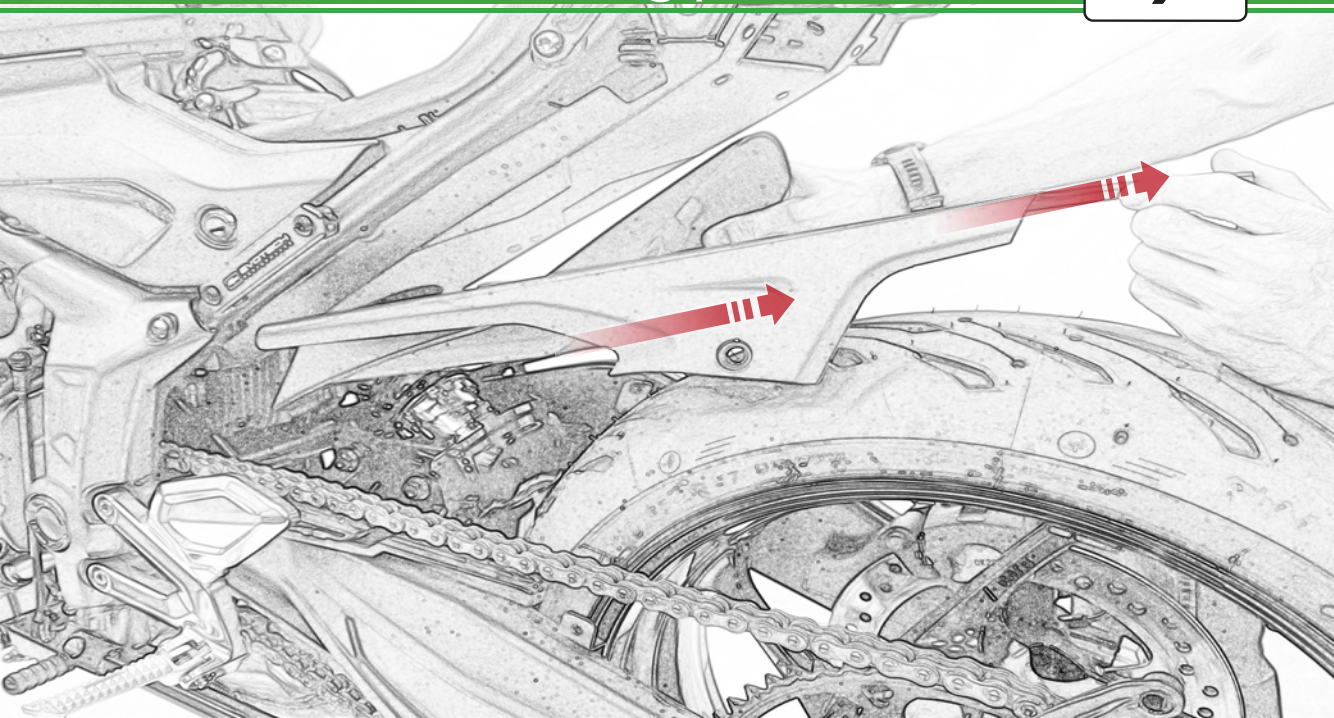

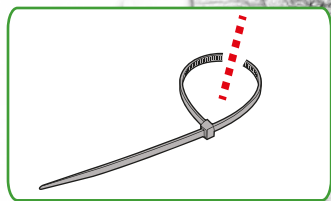
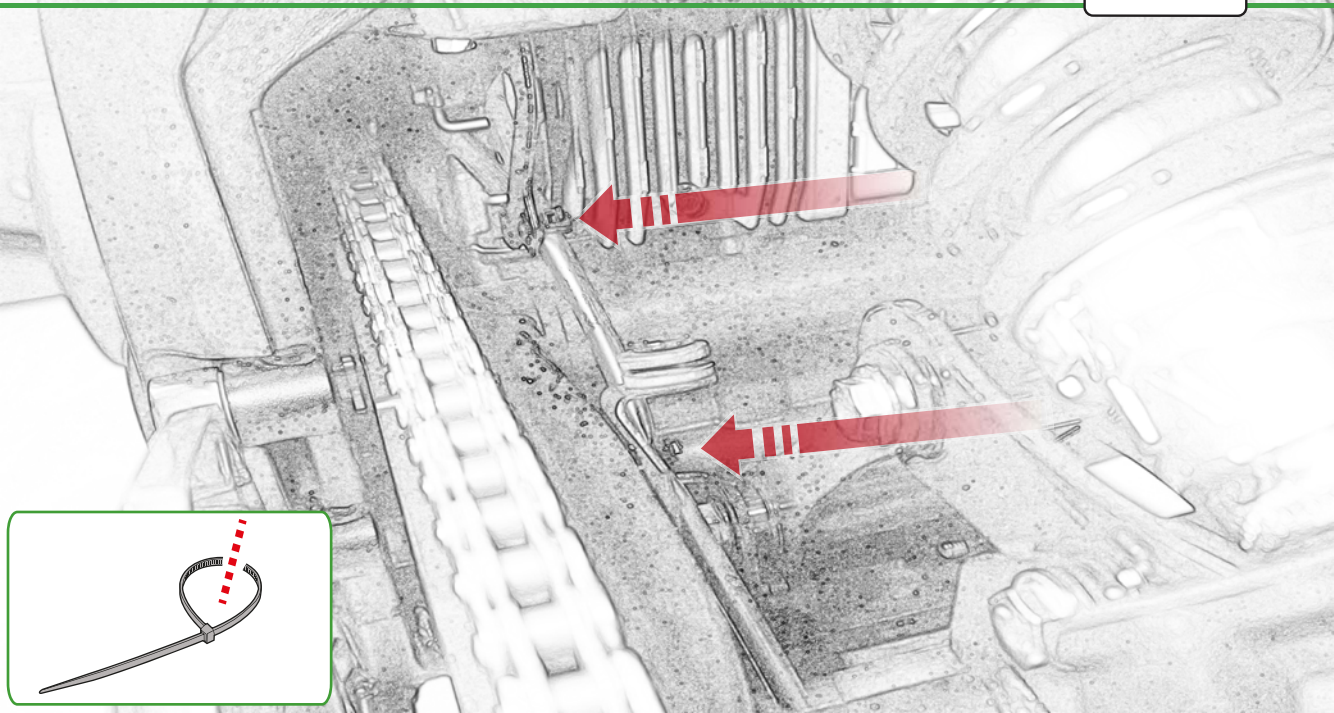

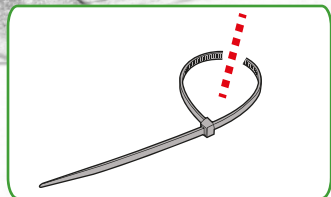
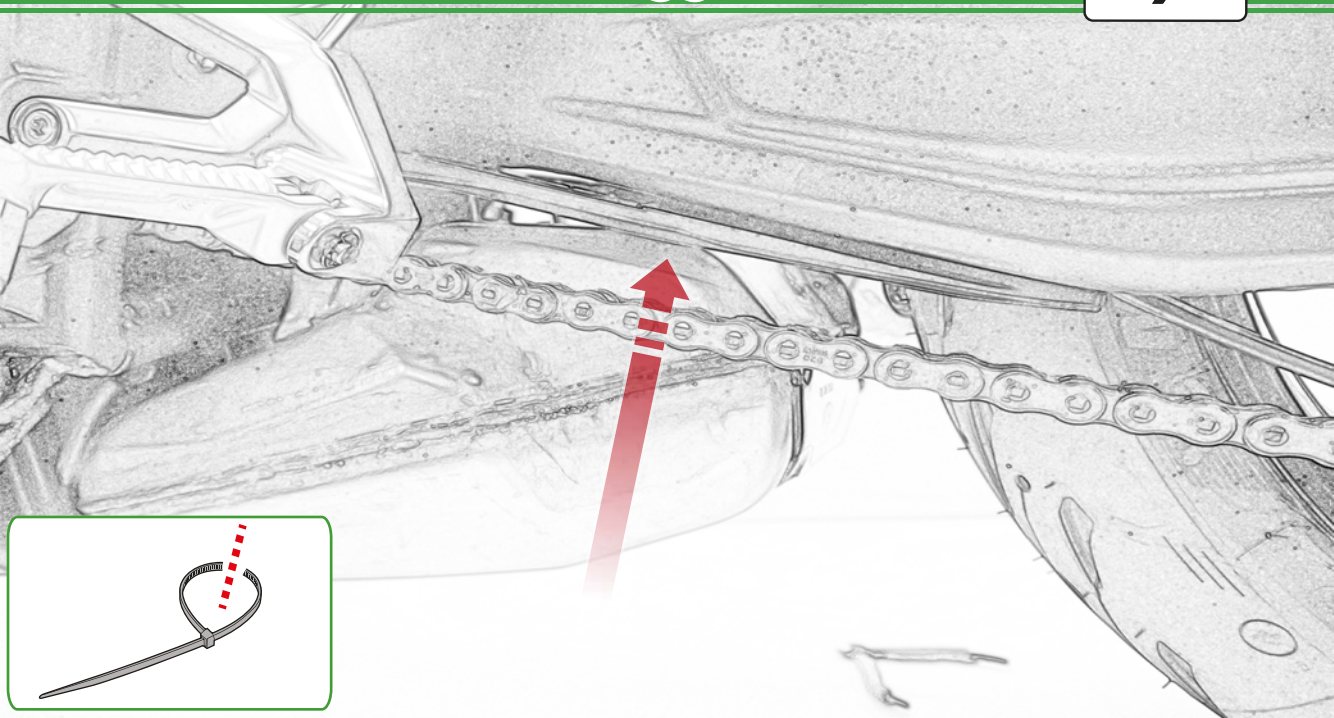

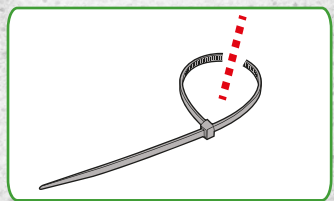
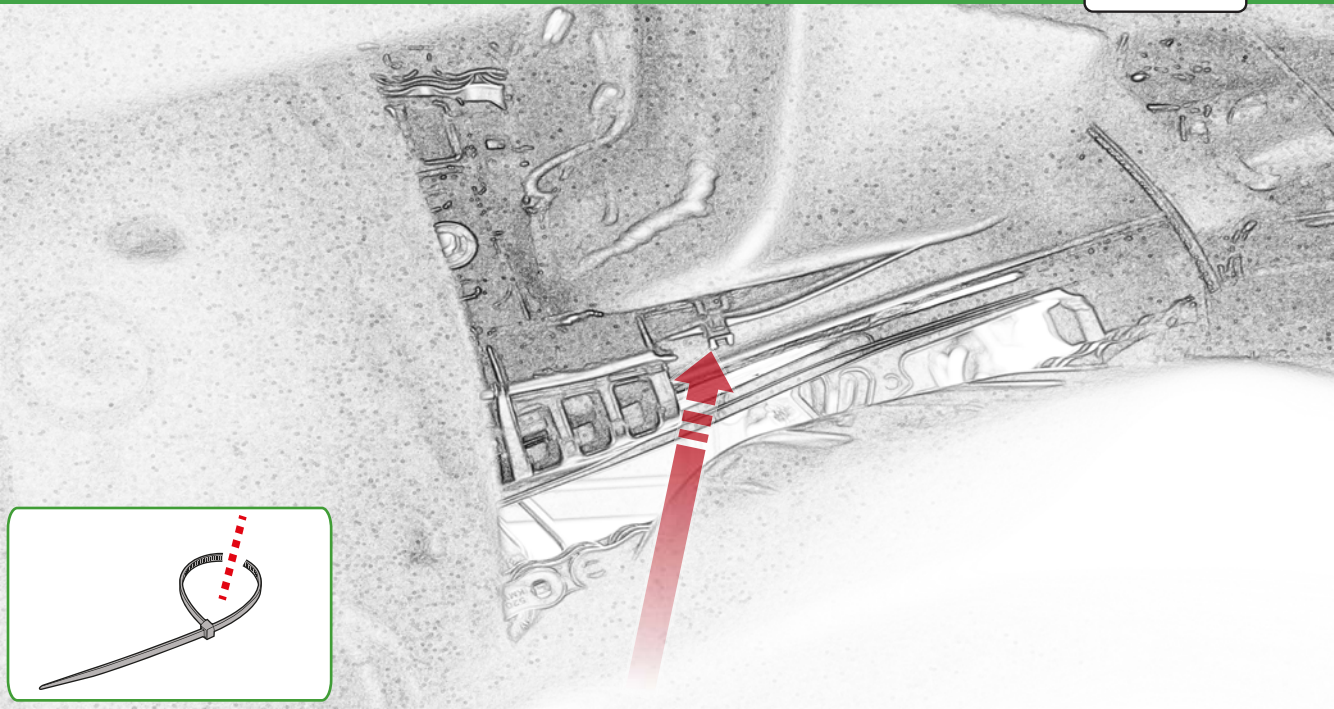

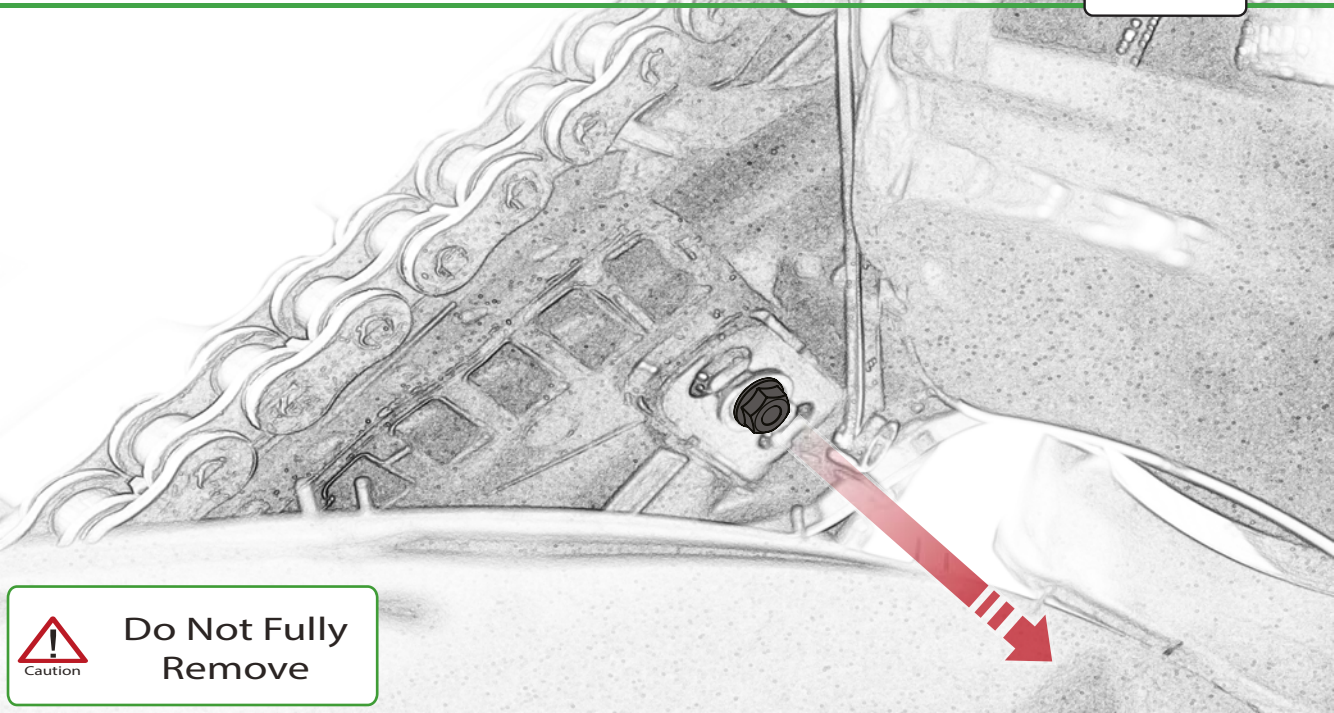

Caution

Do Not Fully
Remove

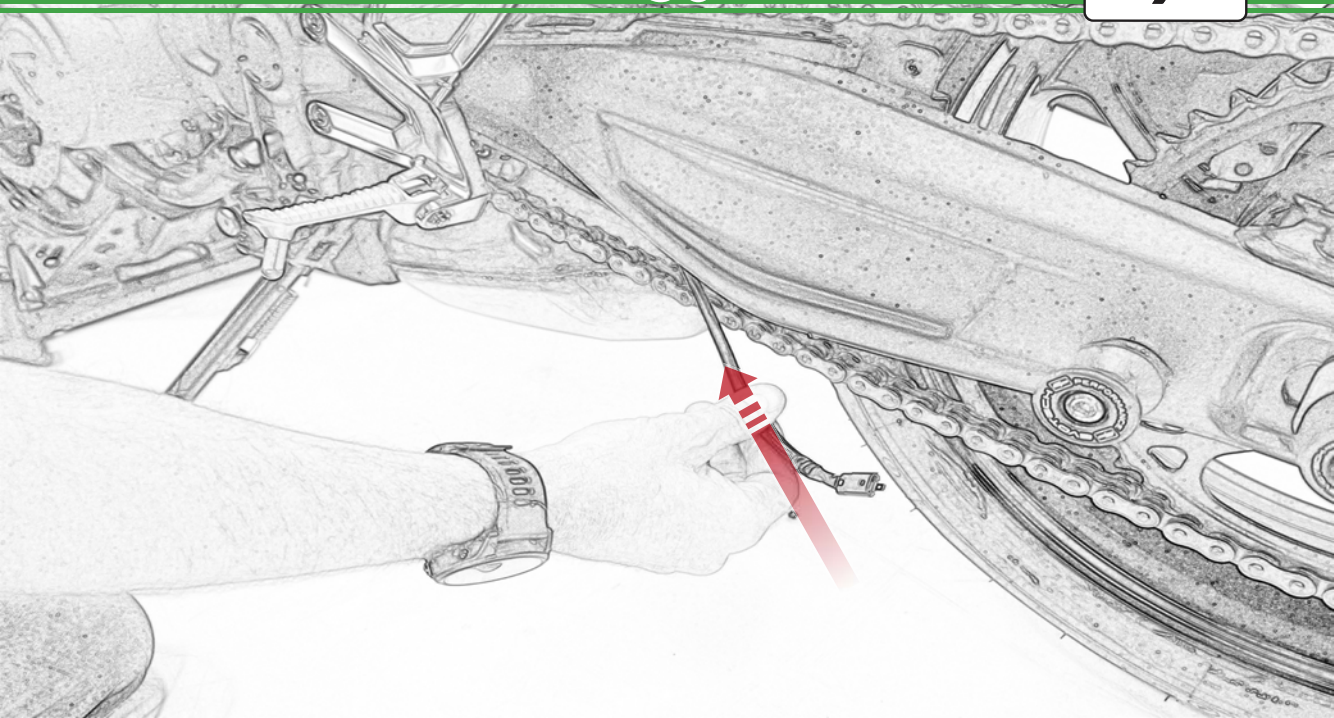

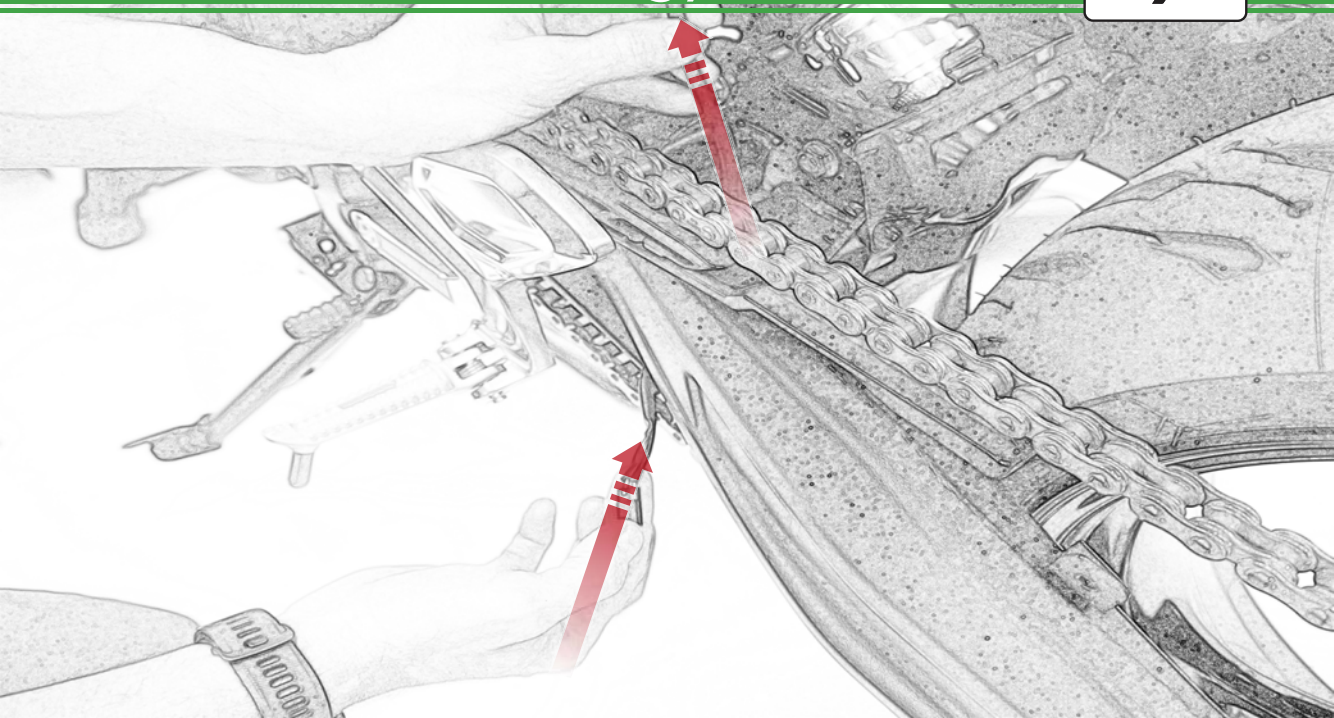

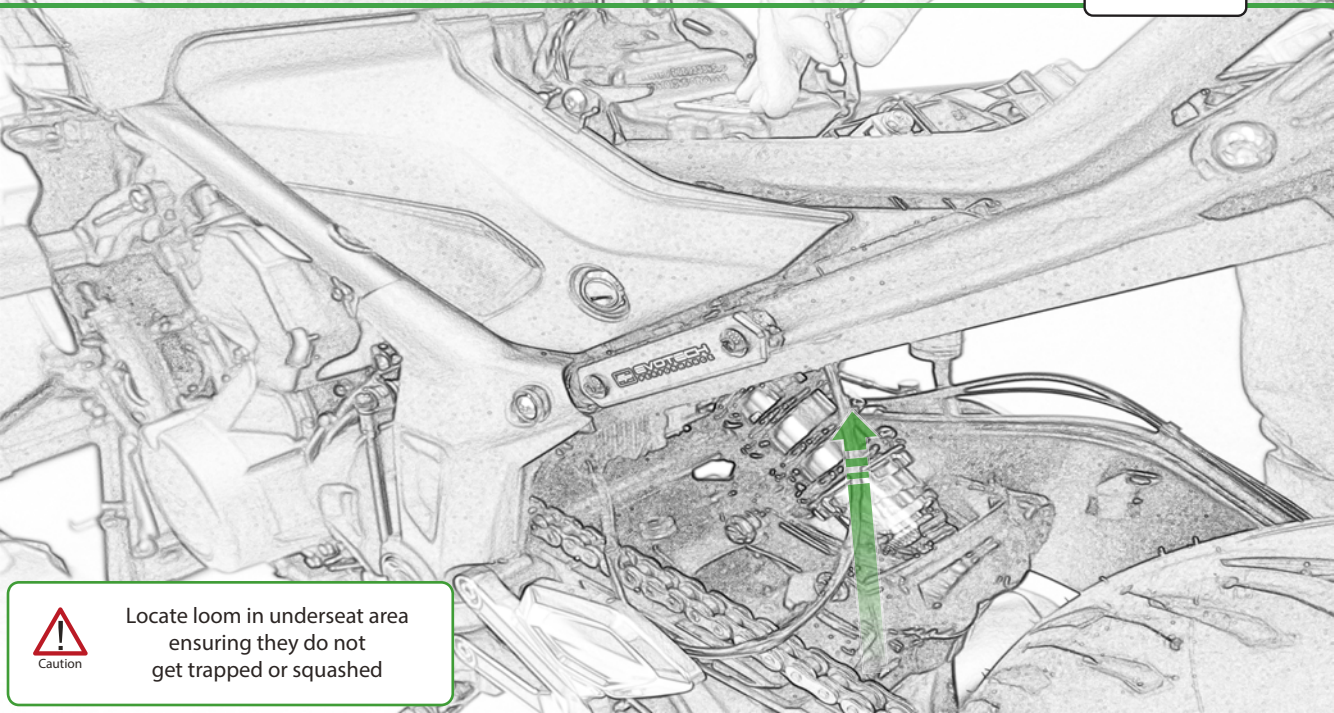

Caution

Locate loom in underseat area
ensuring they do not
get trapped or squashed

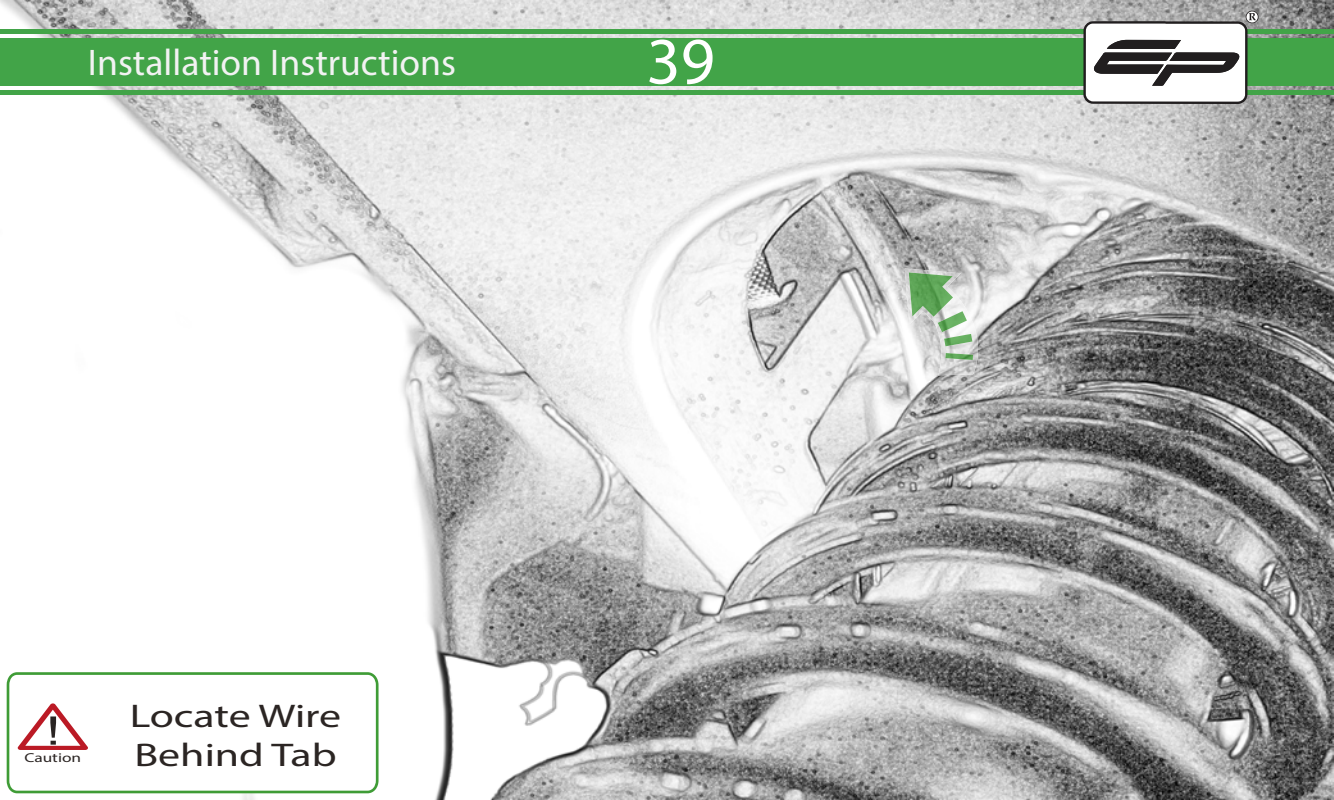

Caution

Locate Wire
Behind Tab









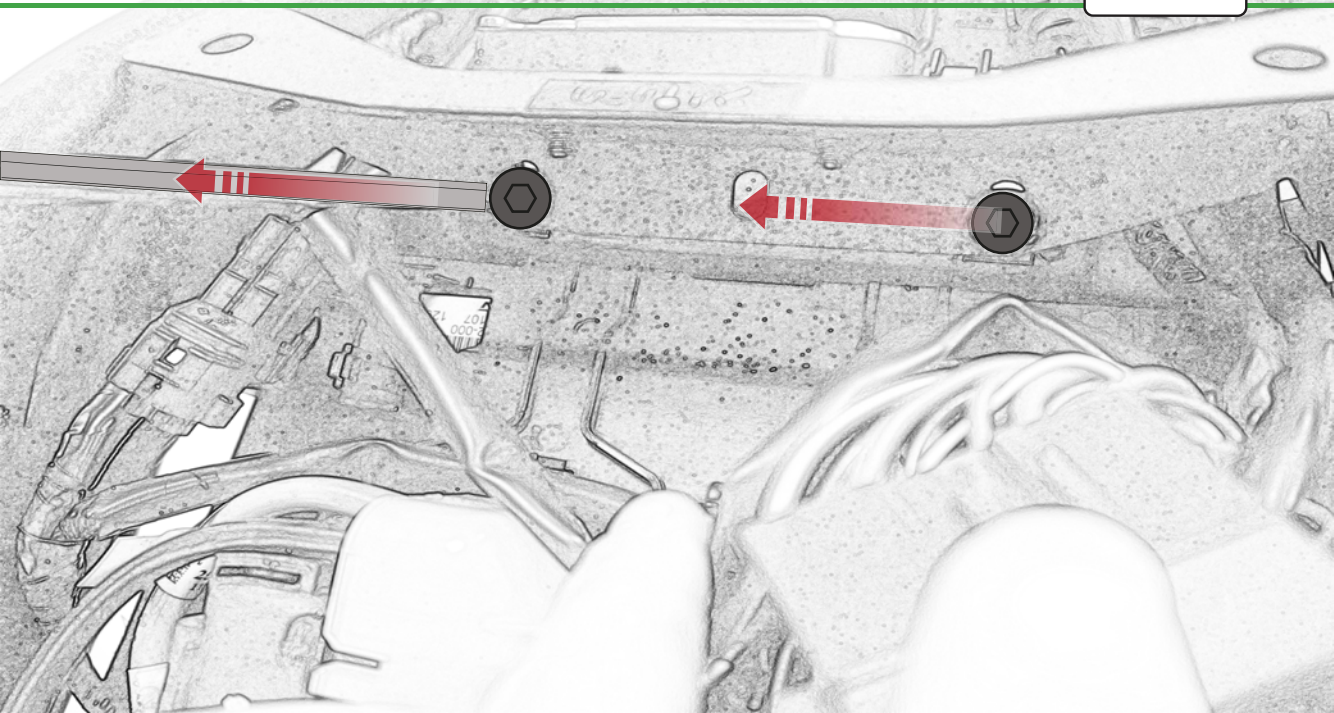

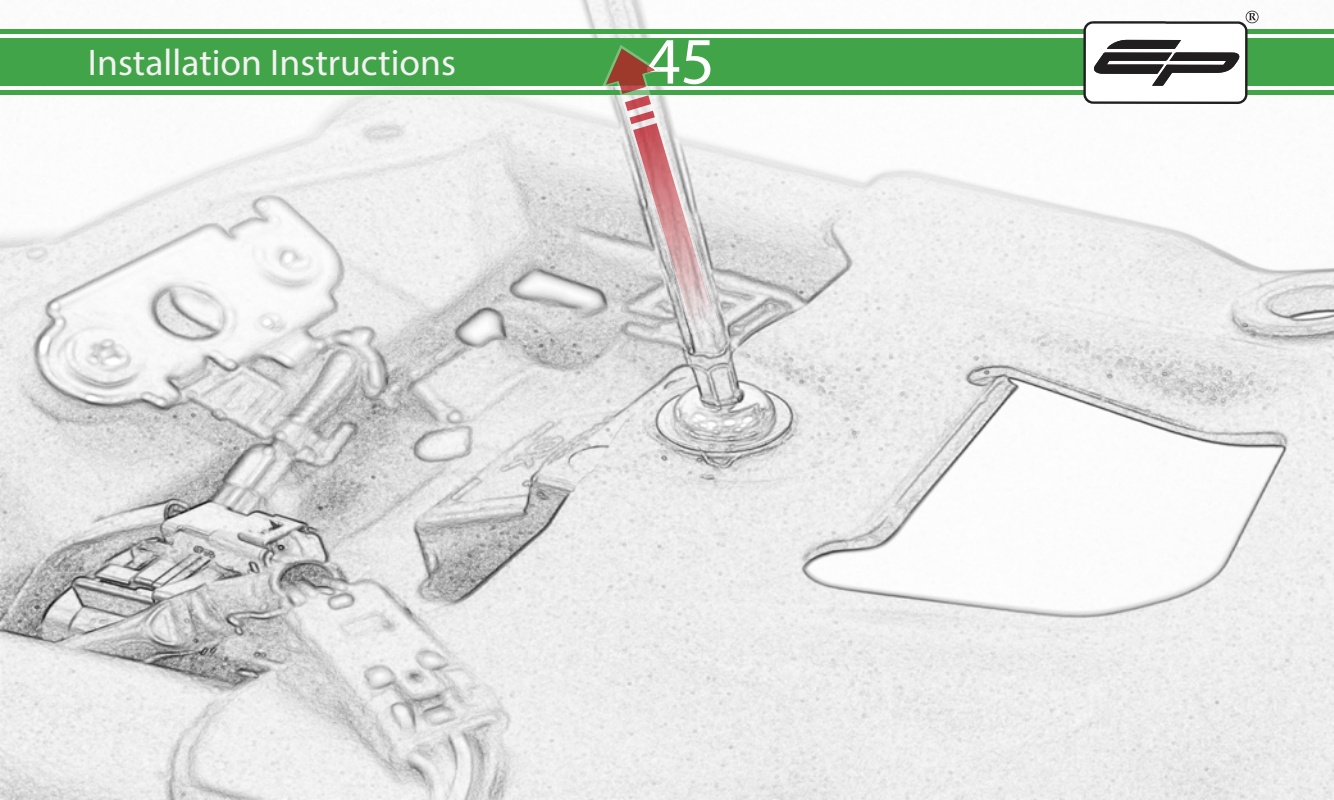

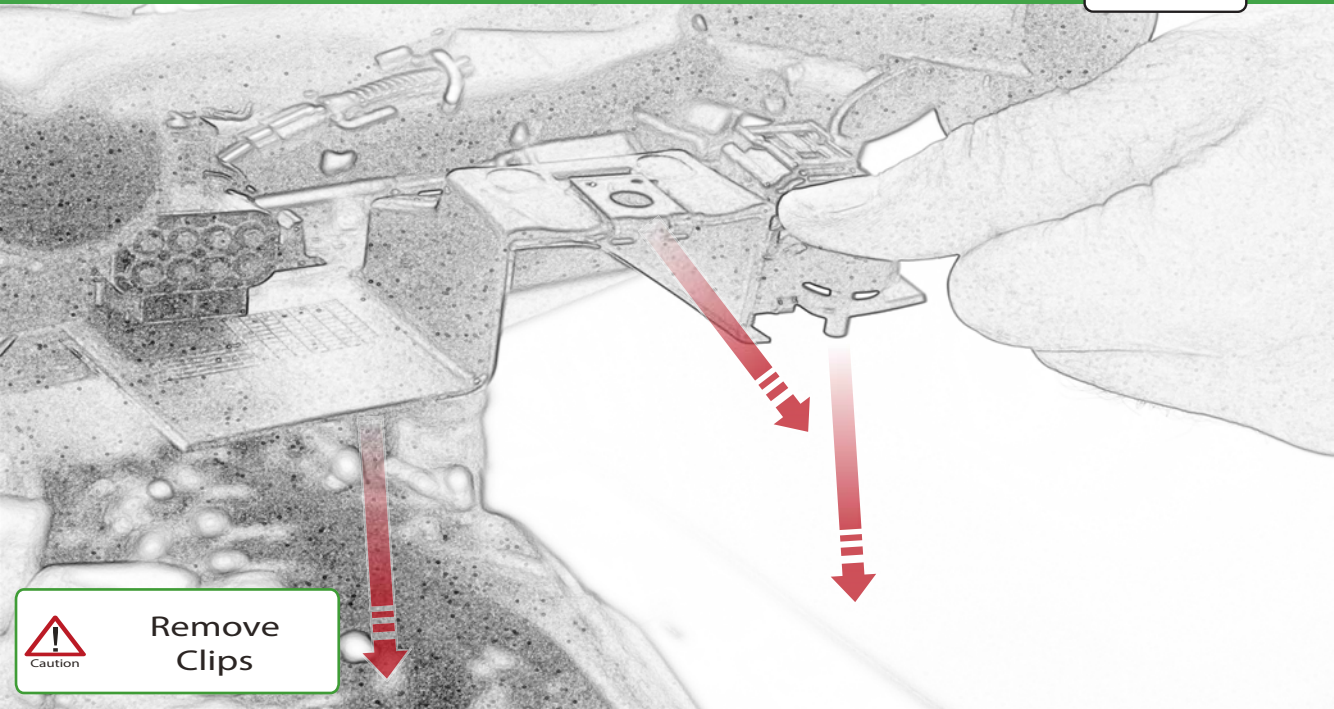

Remove
Clips

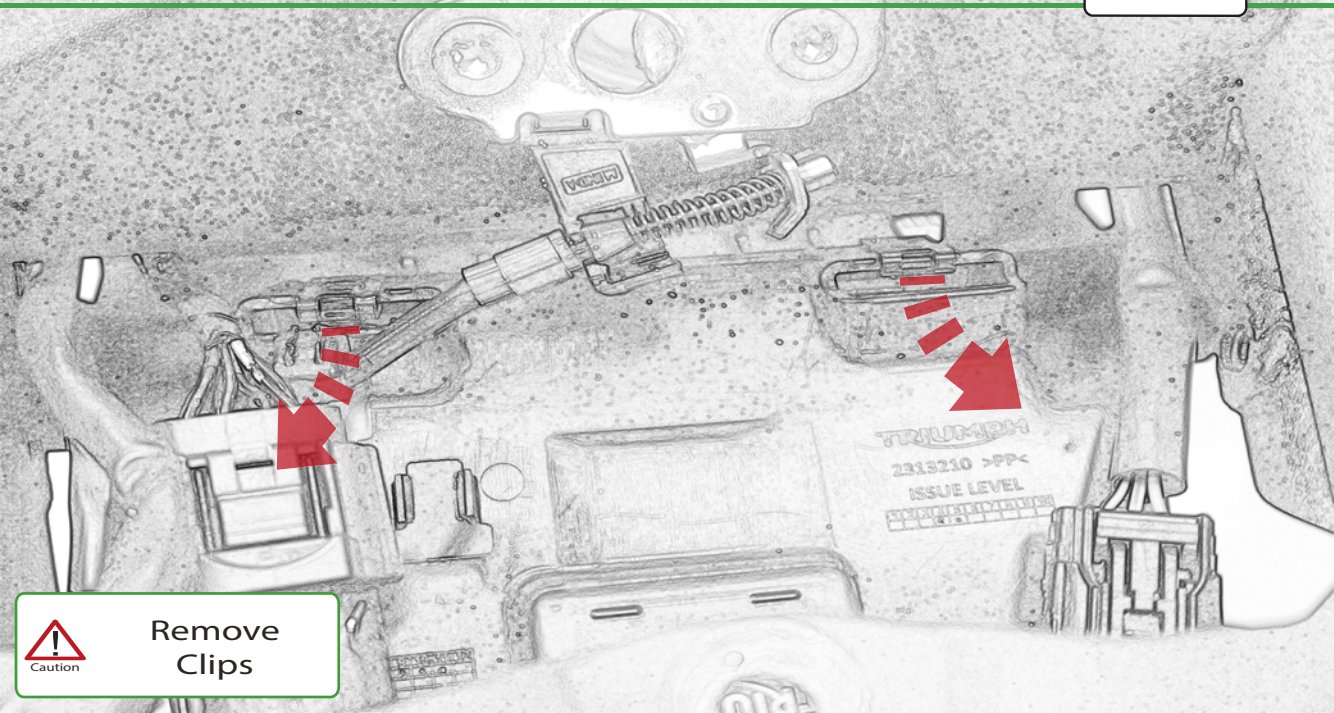

Remove
Clips

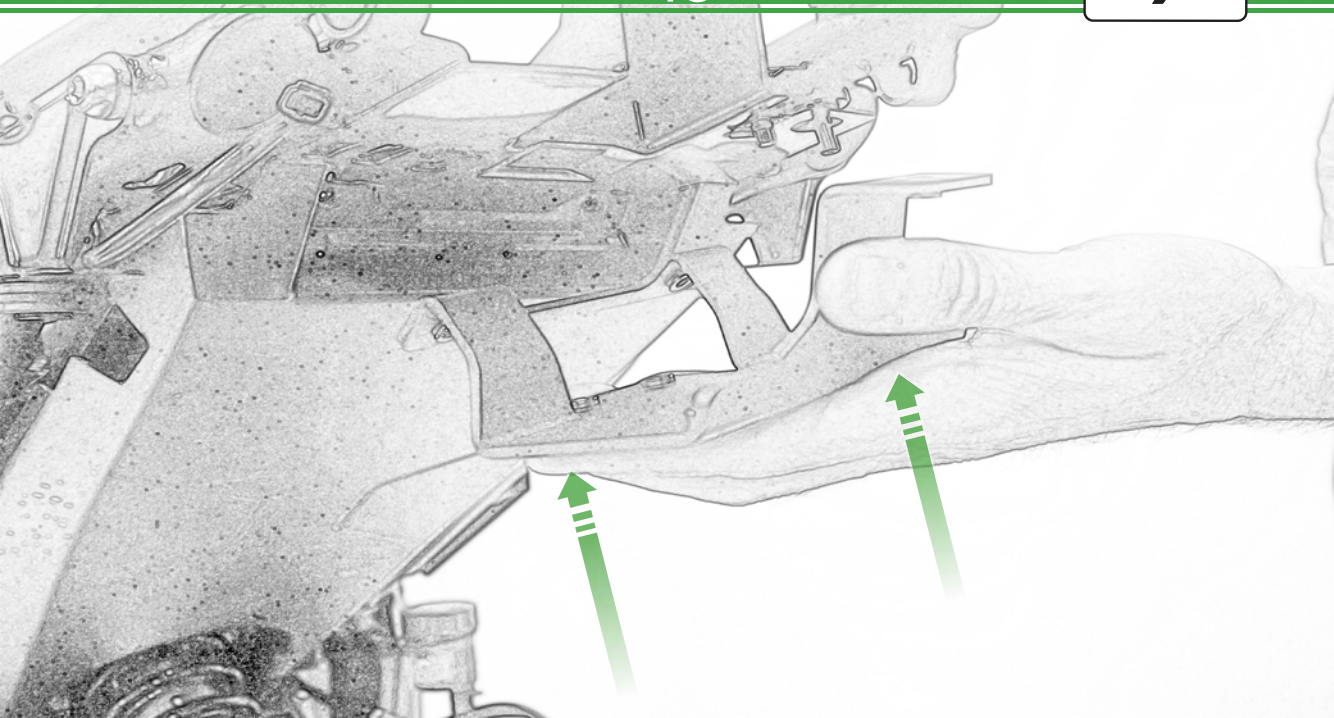

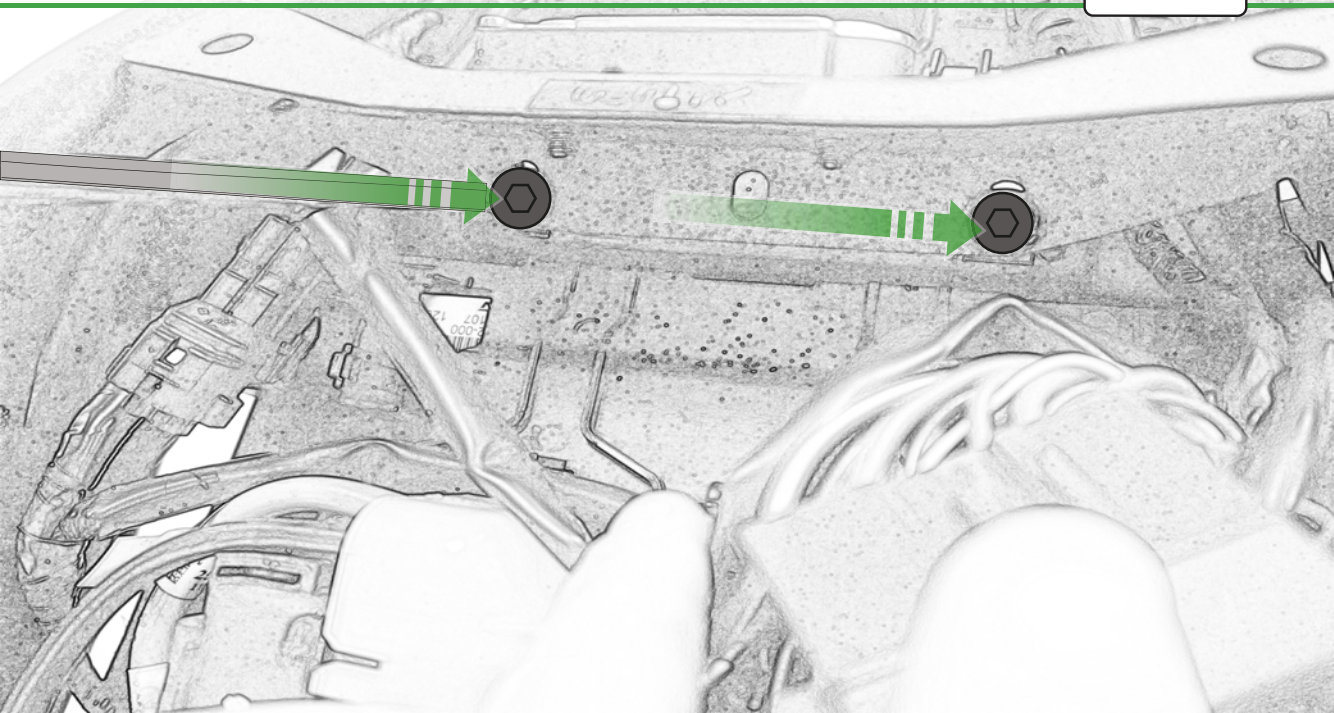

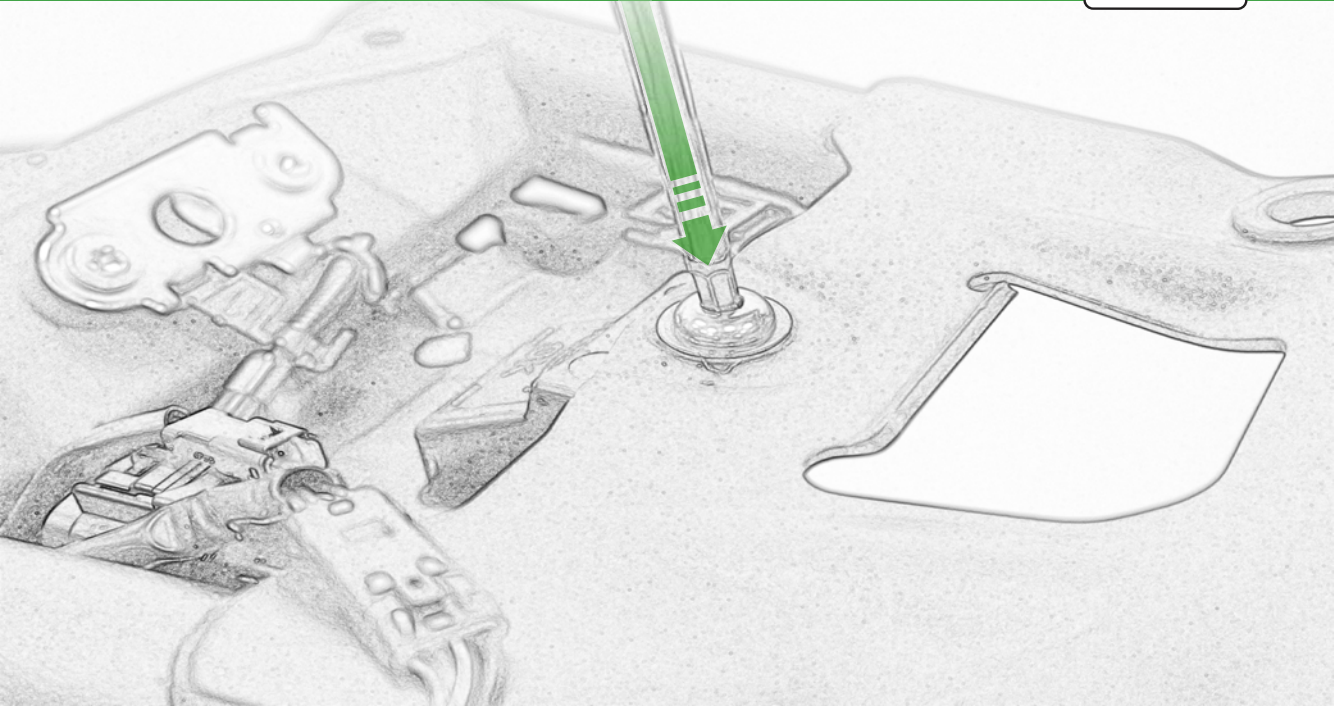

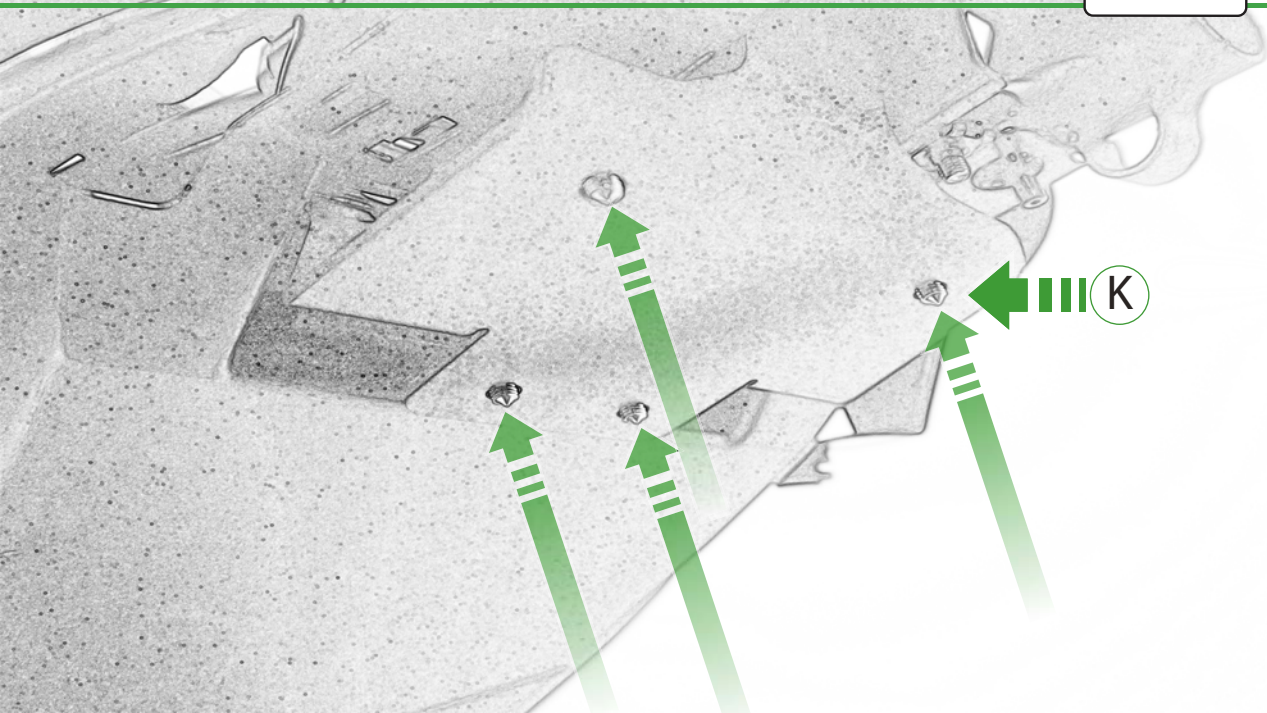

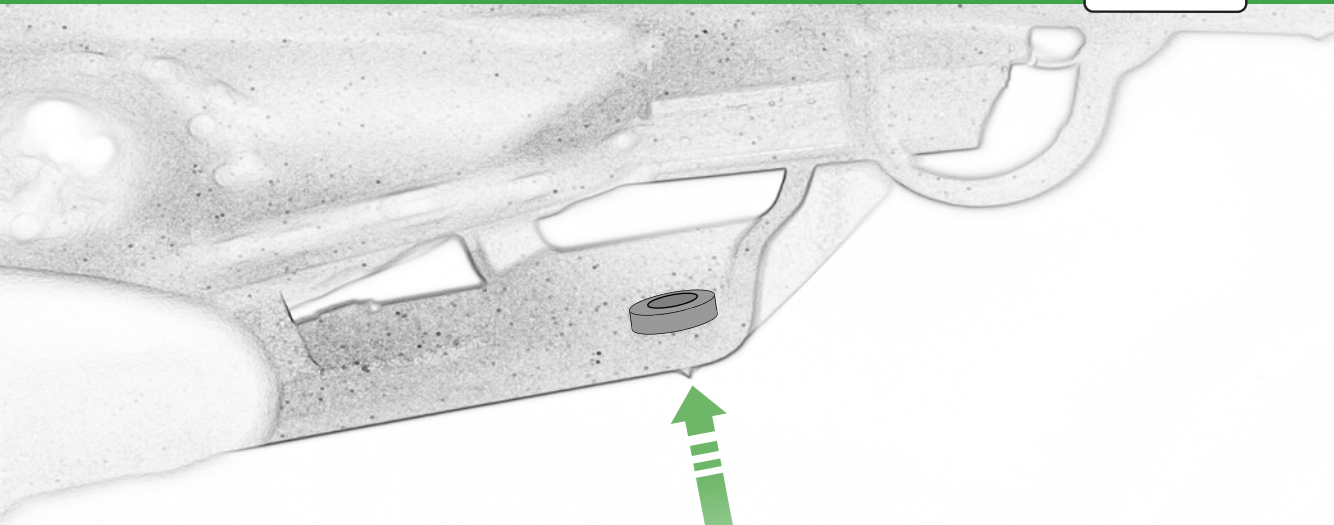

Caution

Set Screw Level
With Top Edge

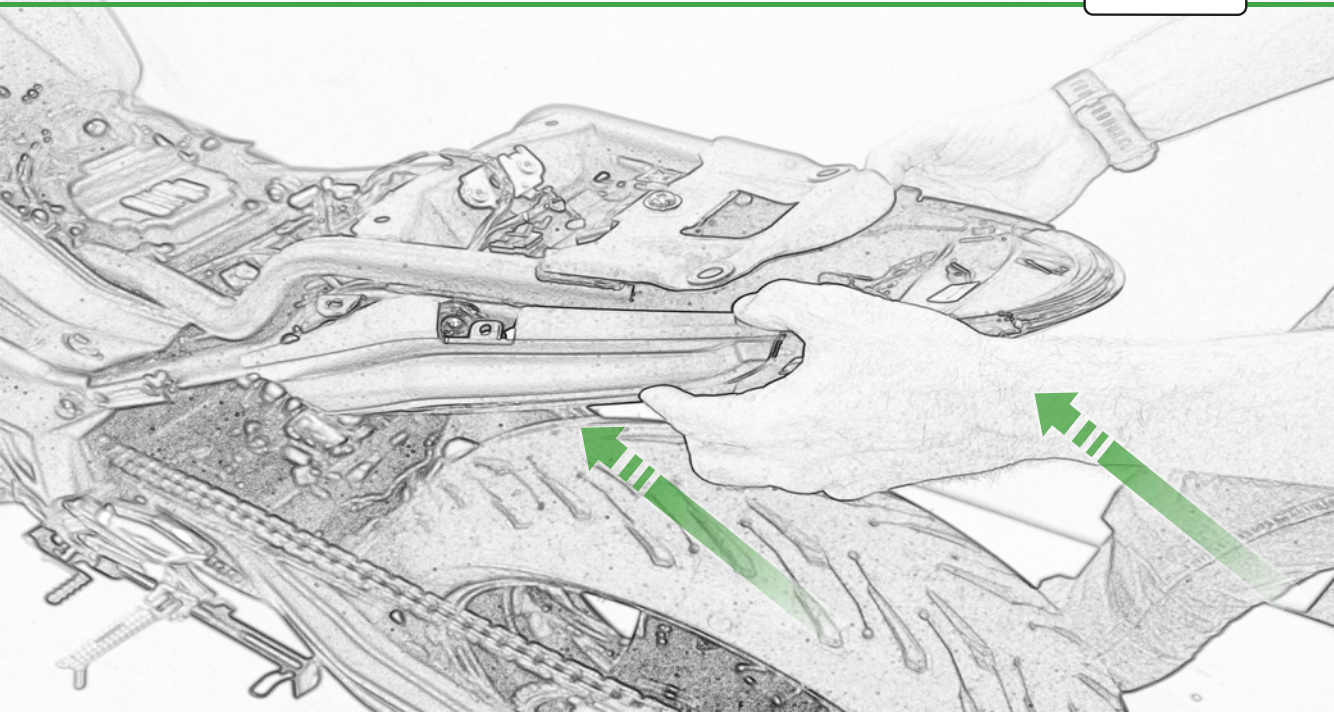

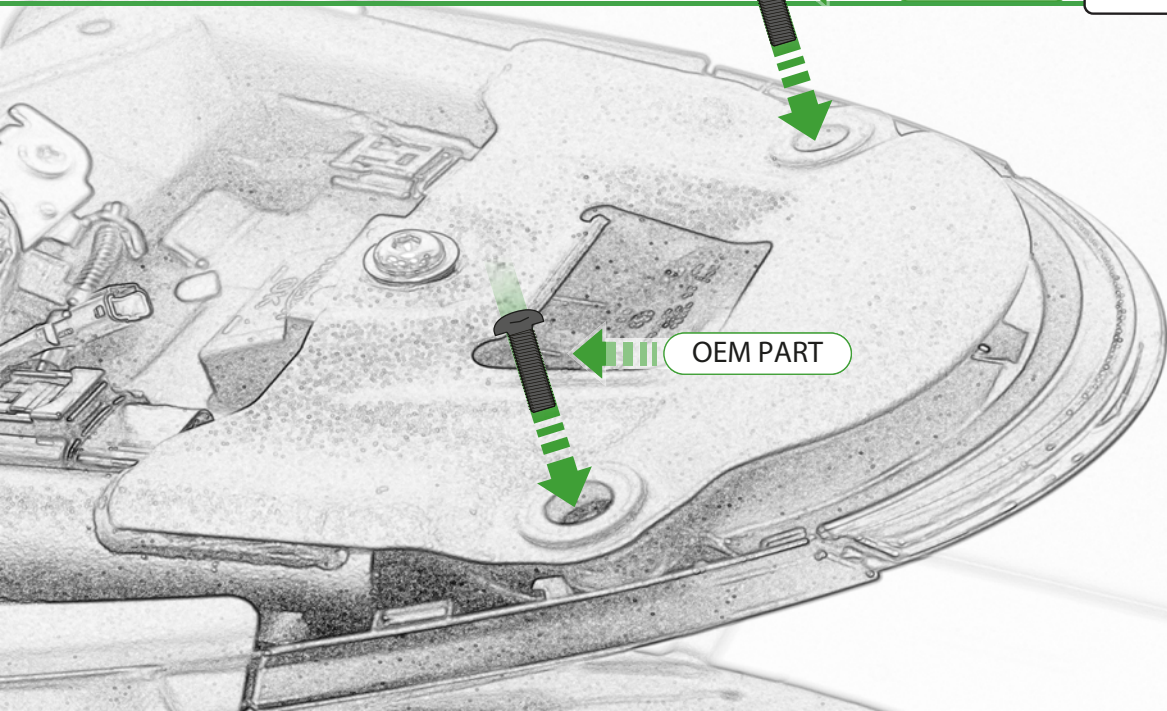

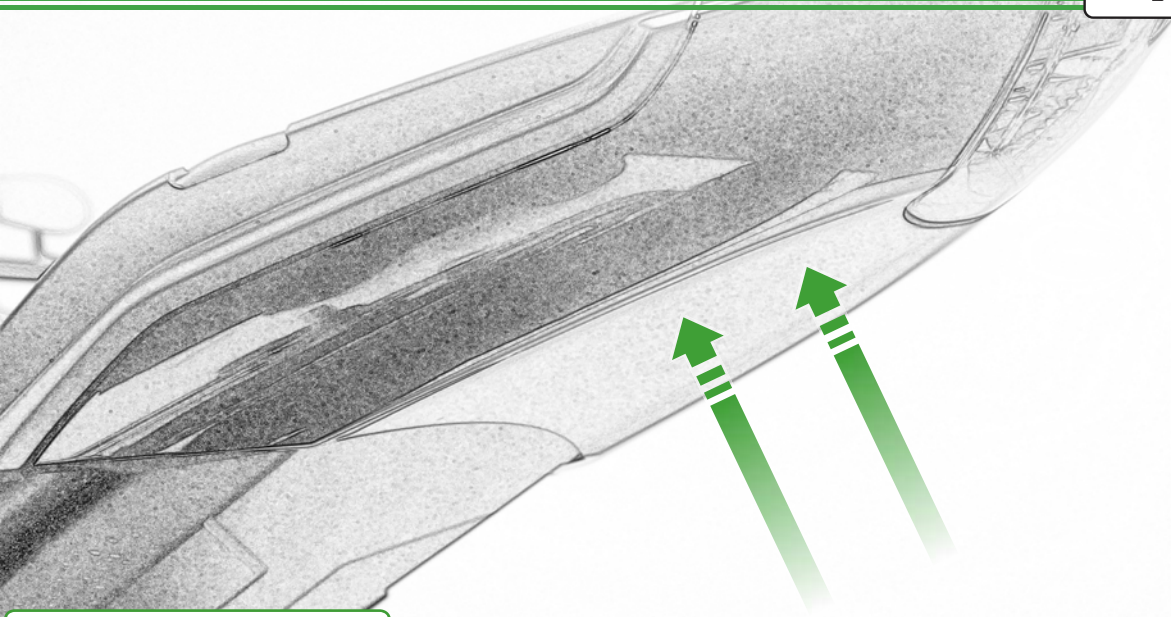

Press The Undertray
Against Marking Pins

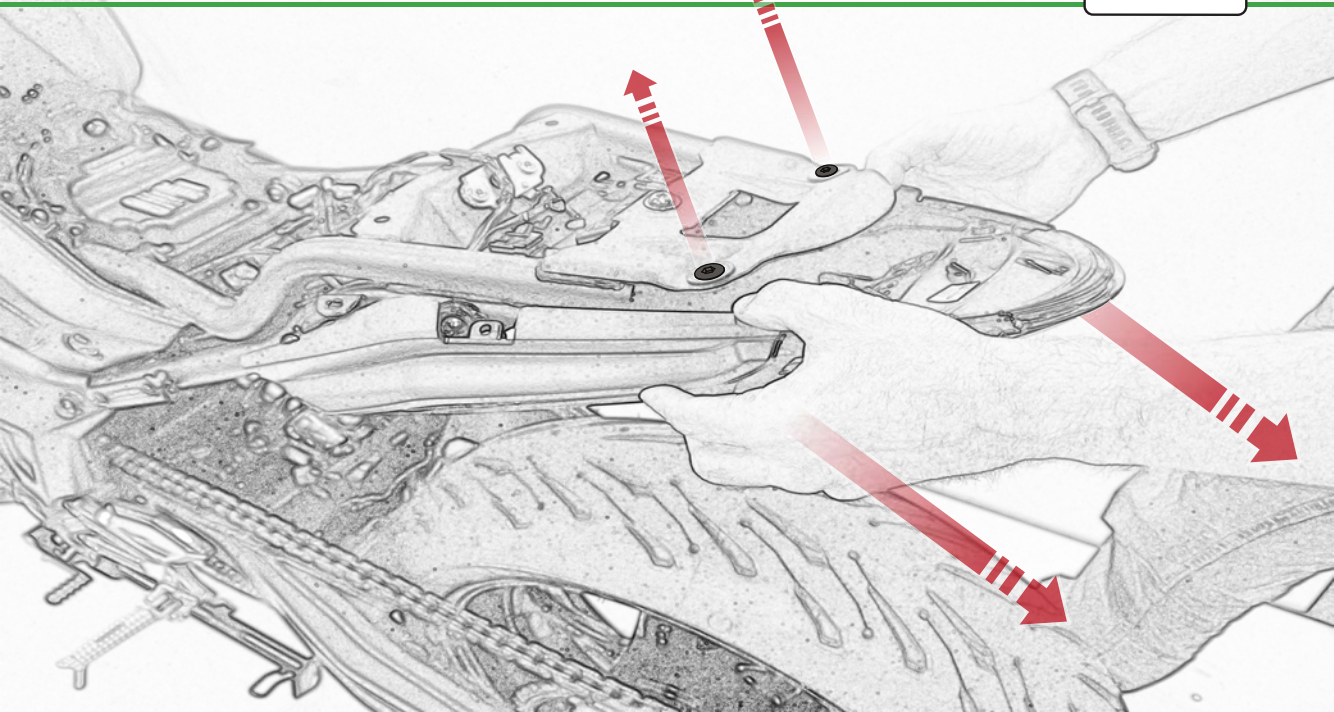

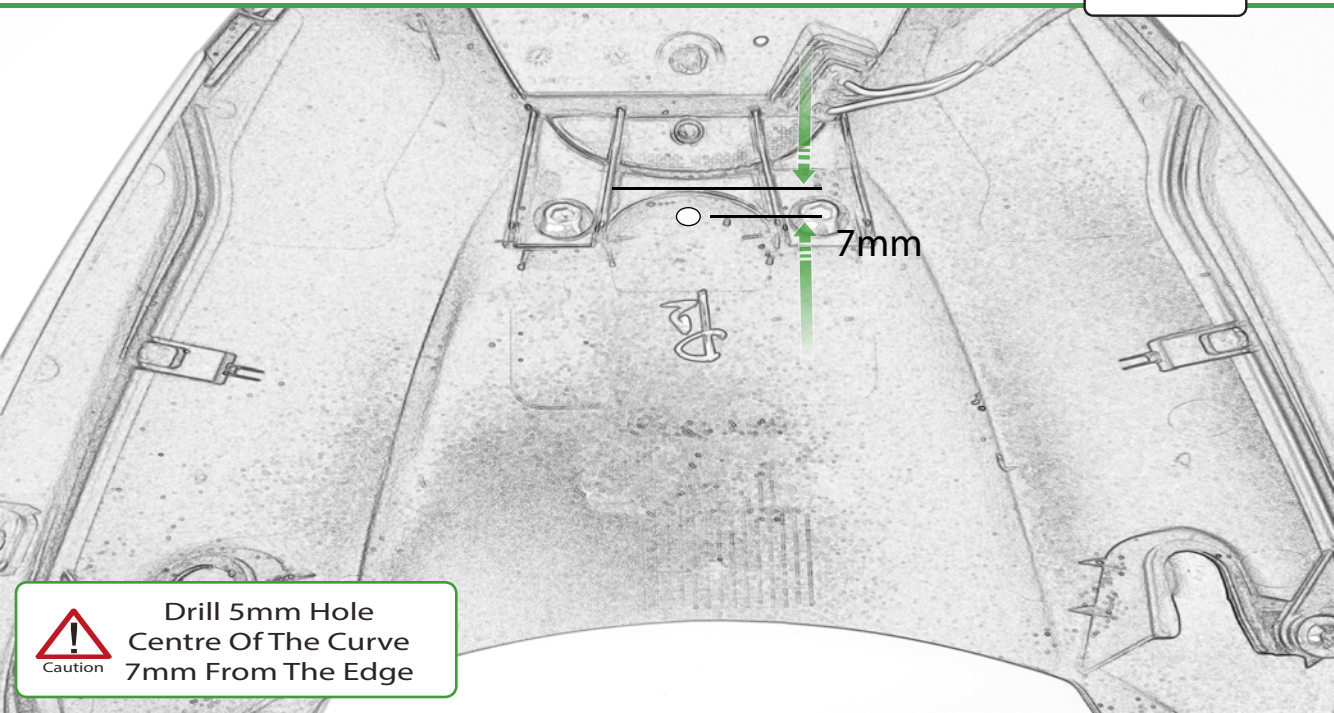

Caution

Drill 5mm Hole
Centre Of The Curve
7mm From The Edge

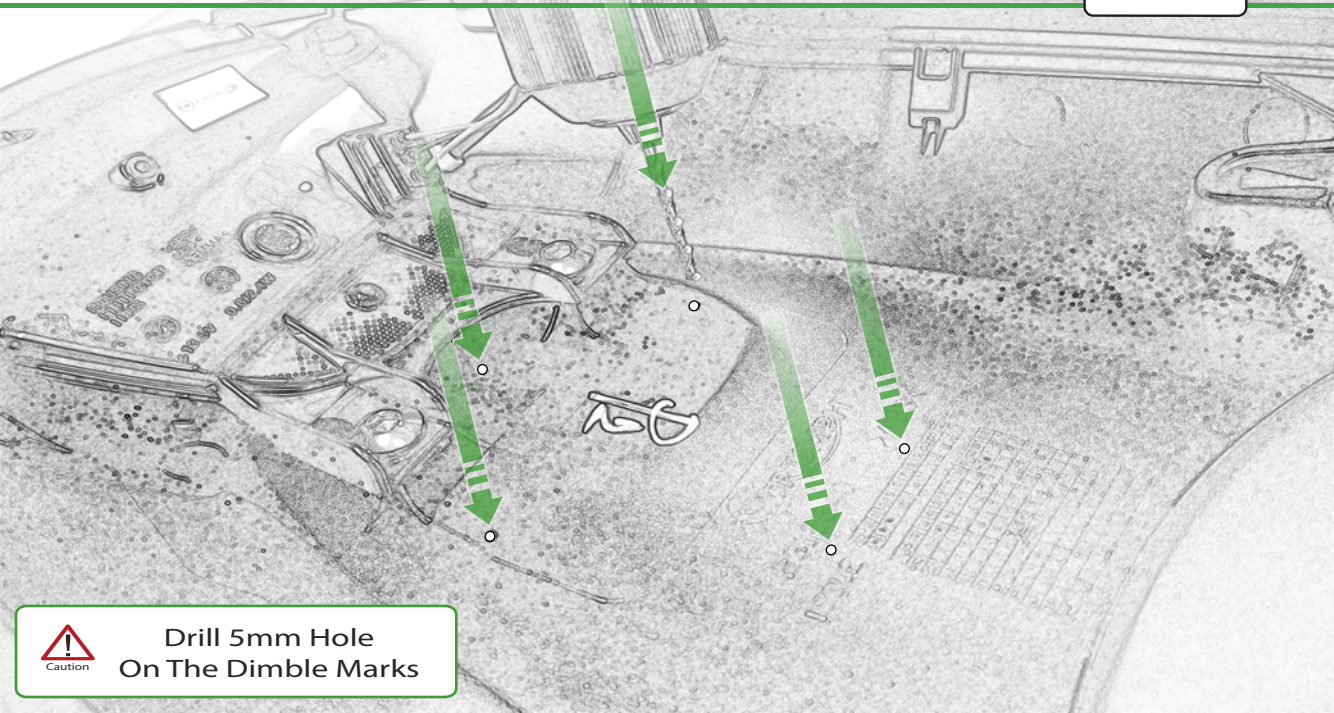

Caution

Drill 5mm Hole
On The Dimple Marks

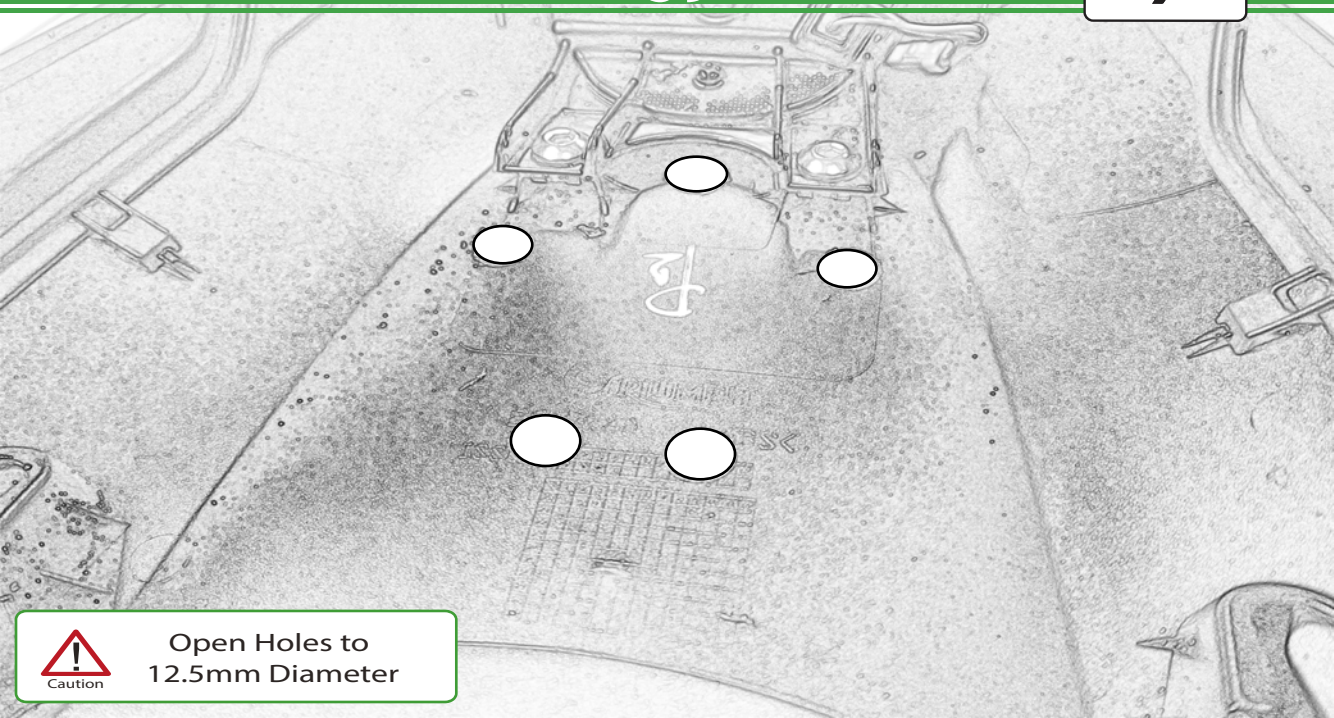

Caution

Open Holes to
12.5mm Diameter

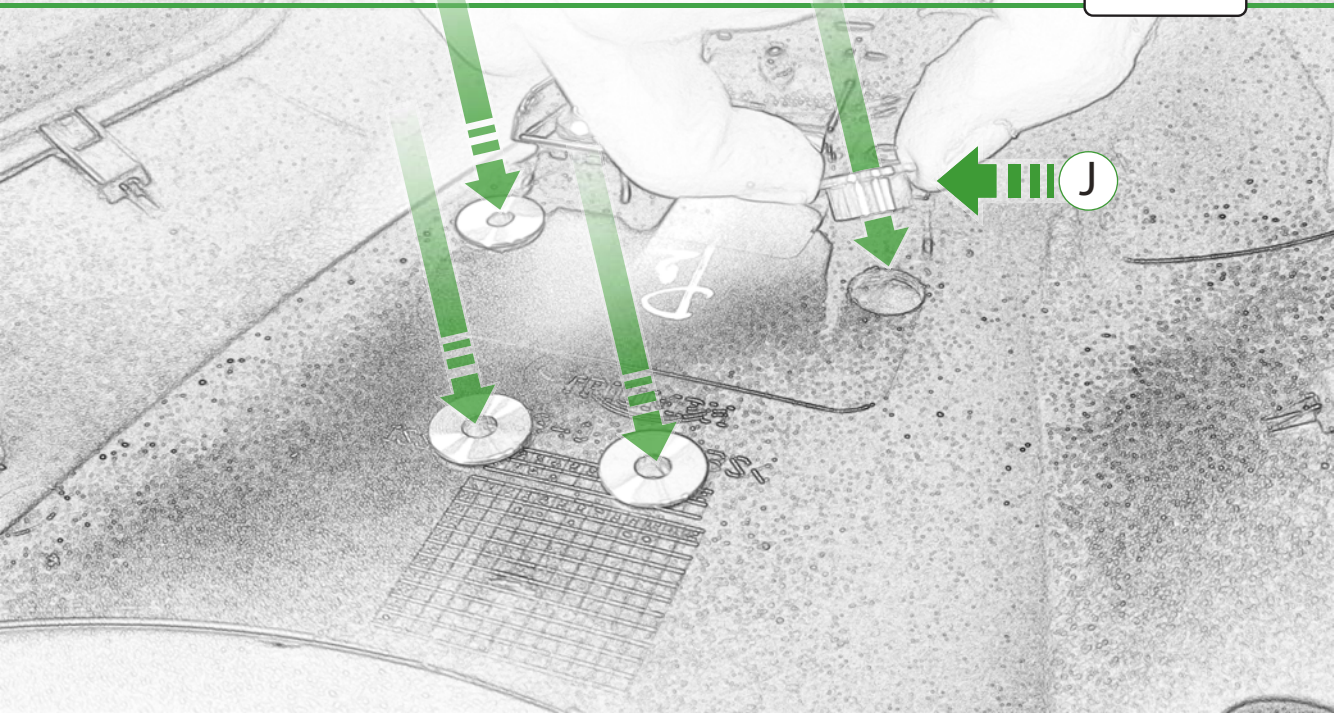

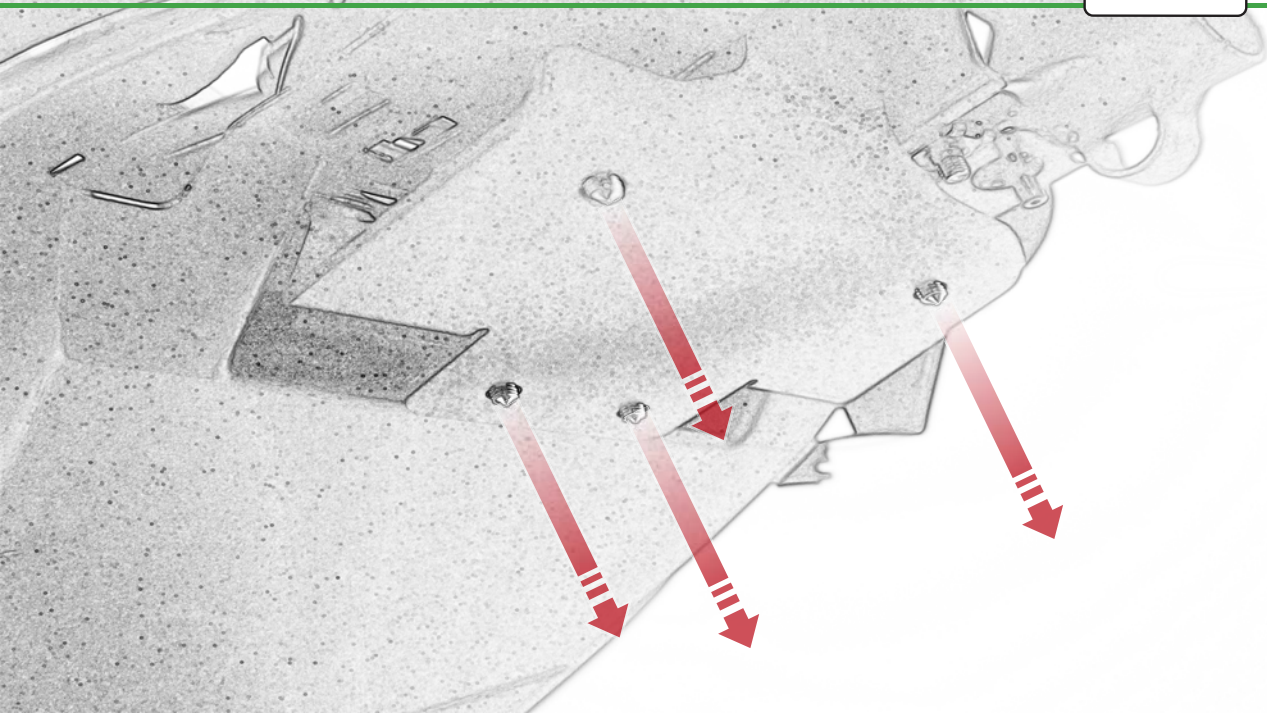

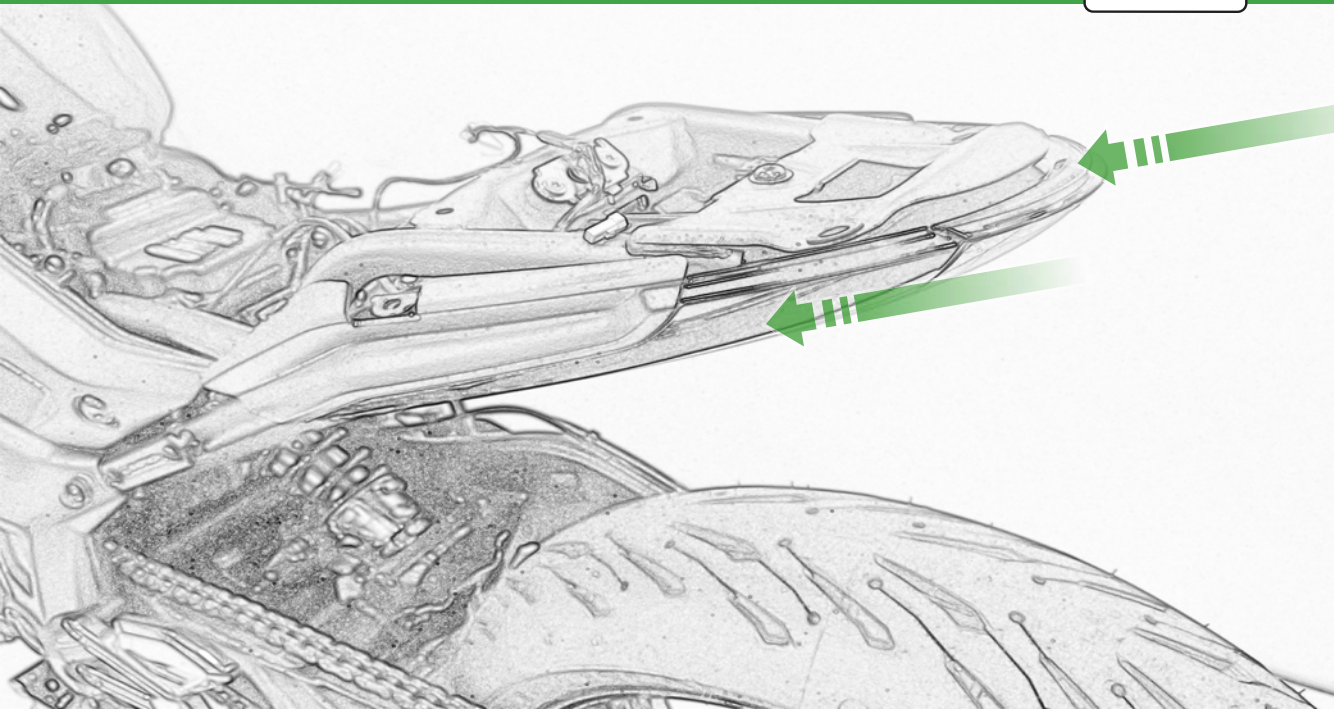



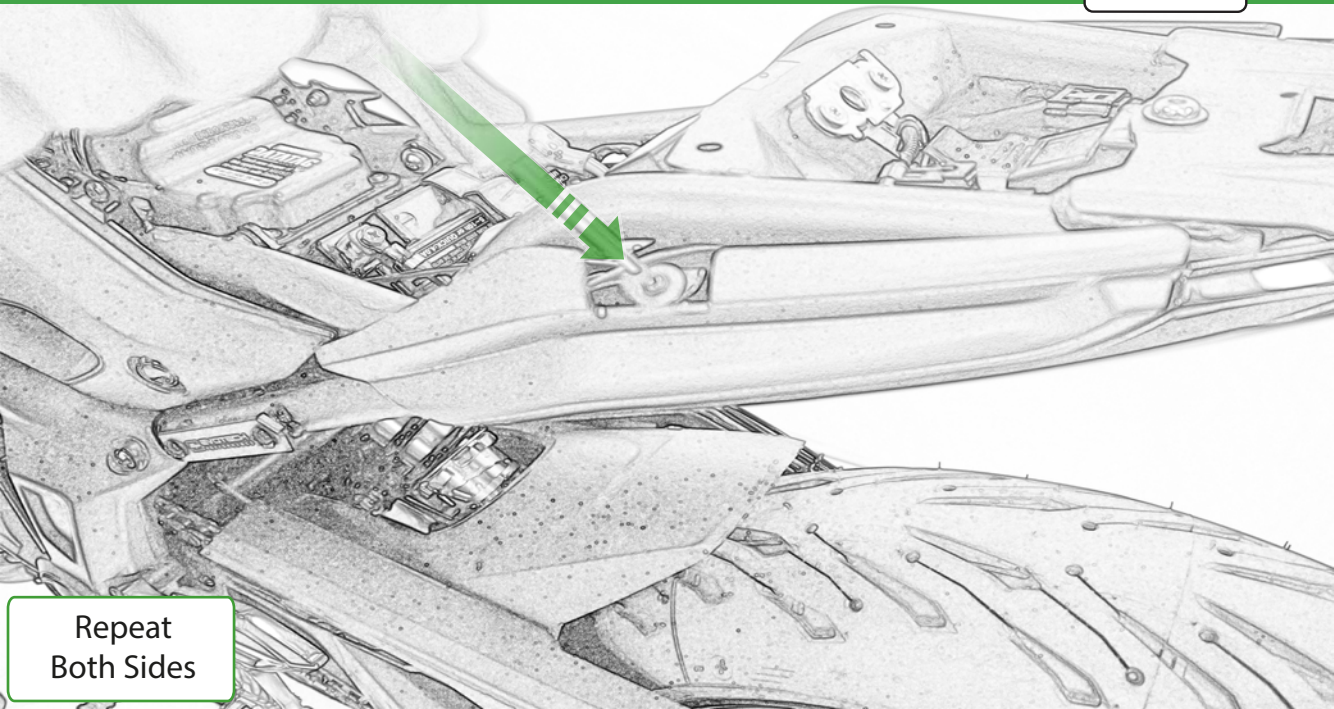

Repeat
Both Sides

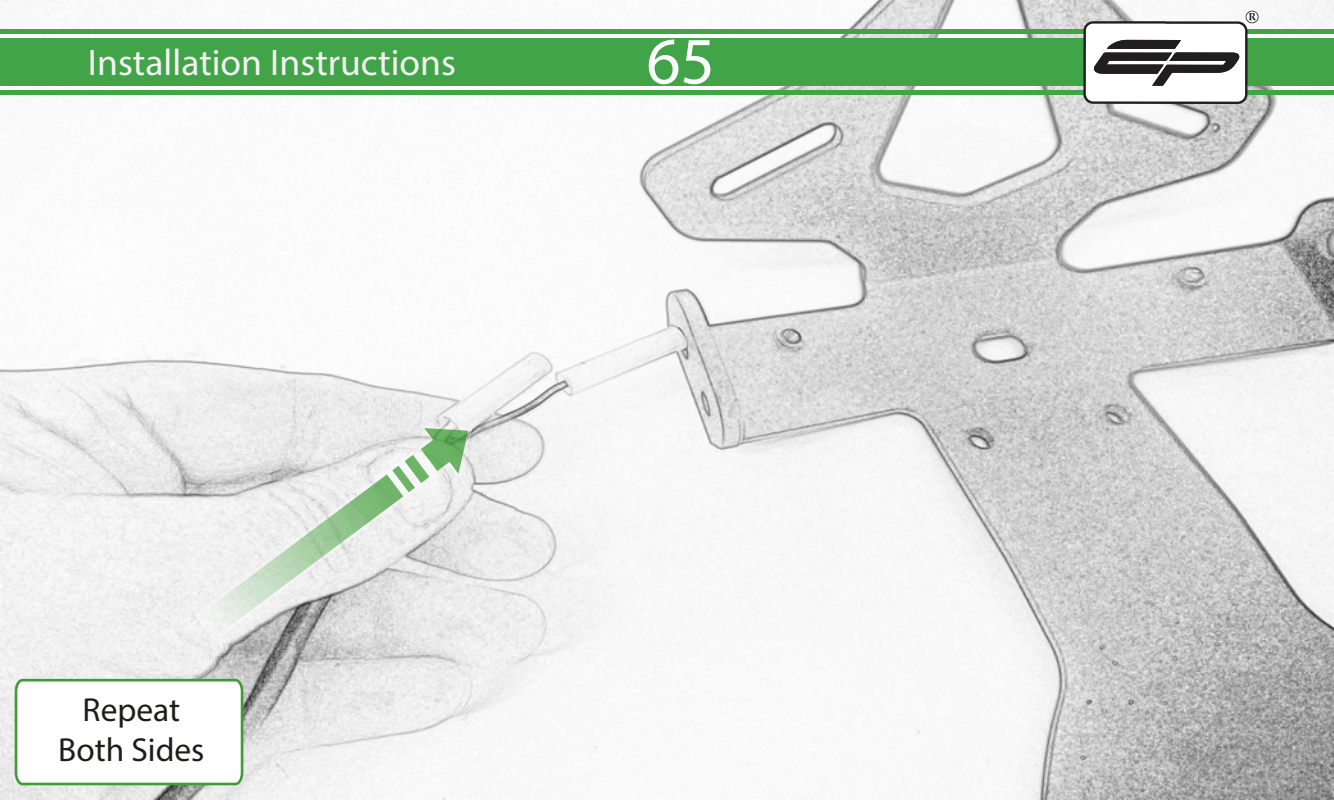

Repeat
Both Sides

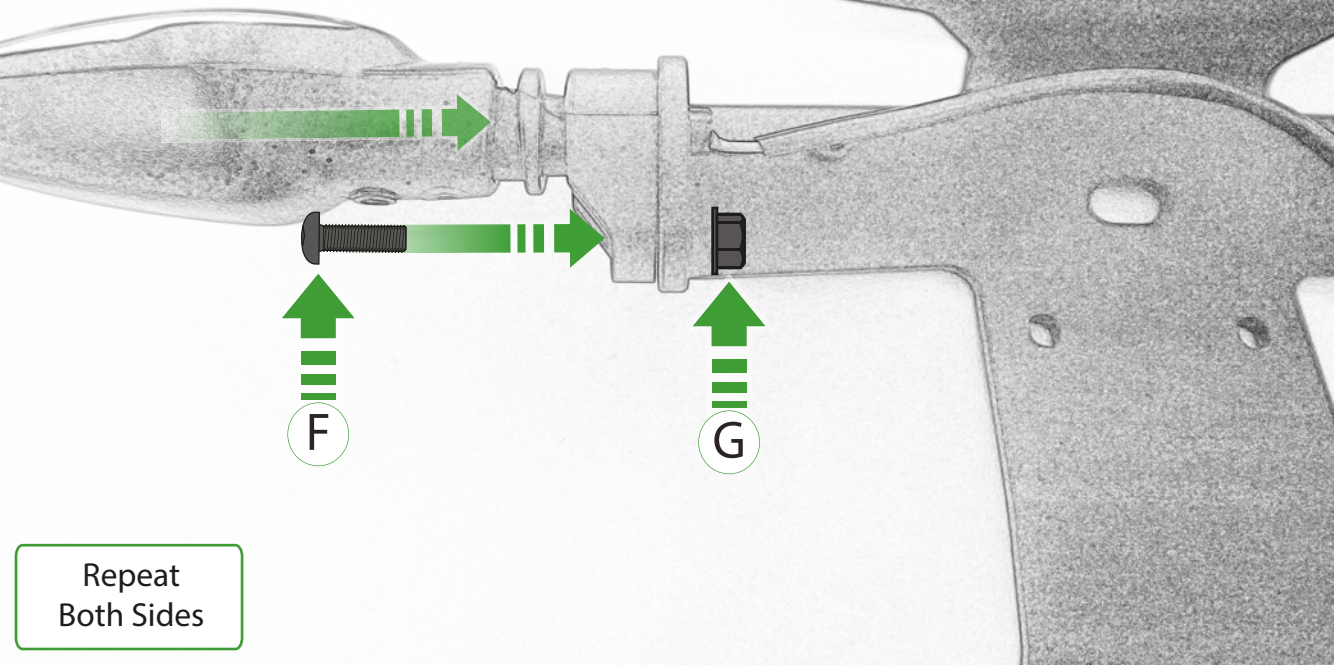



F



G

Repeat
Both Sides

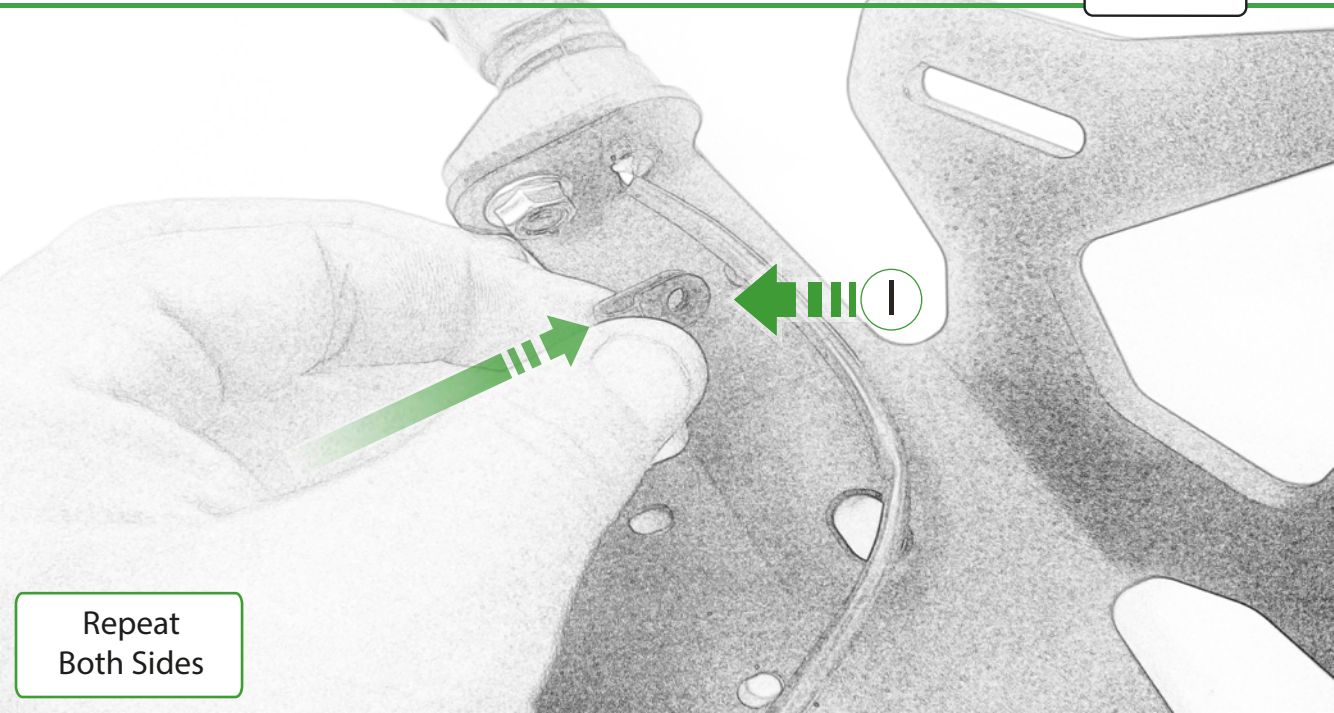

Repeat
Both Sides

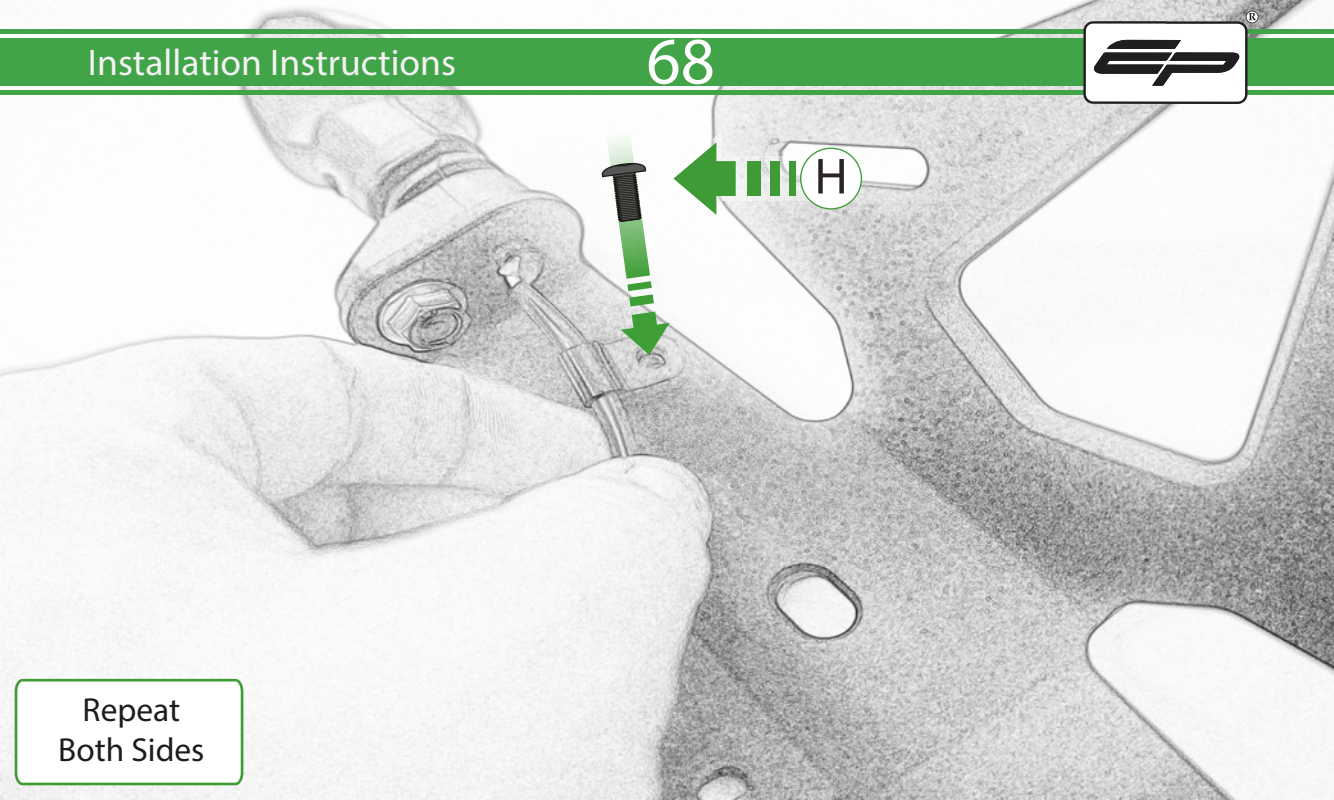

Repeat
Both Sides

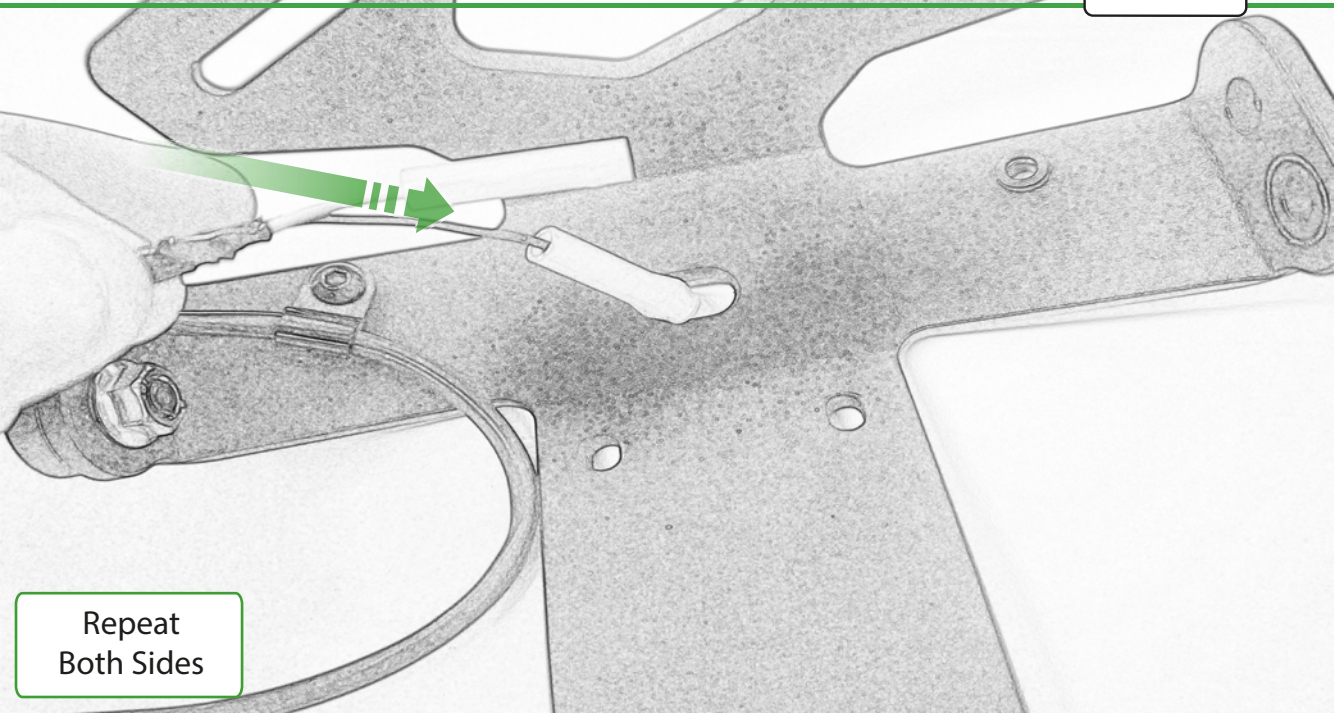

Repeat
Both Sides

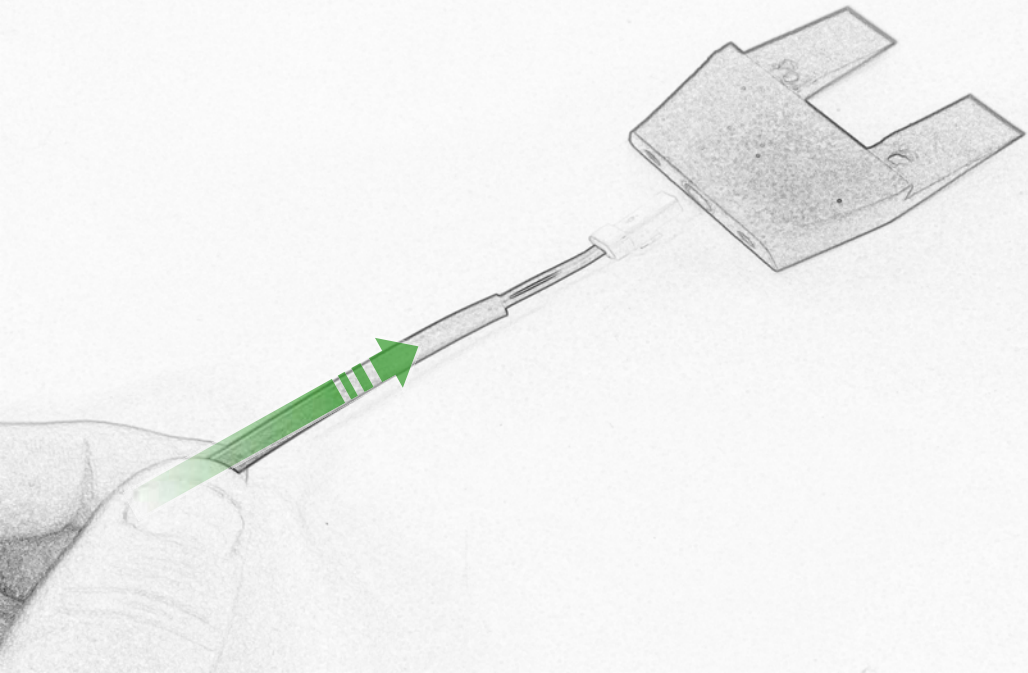

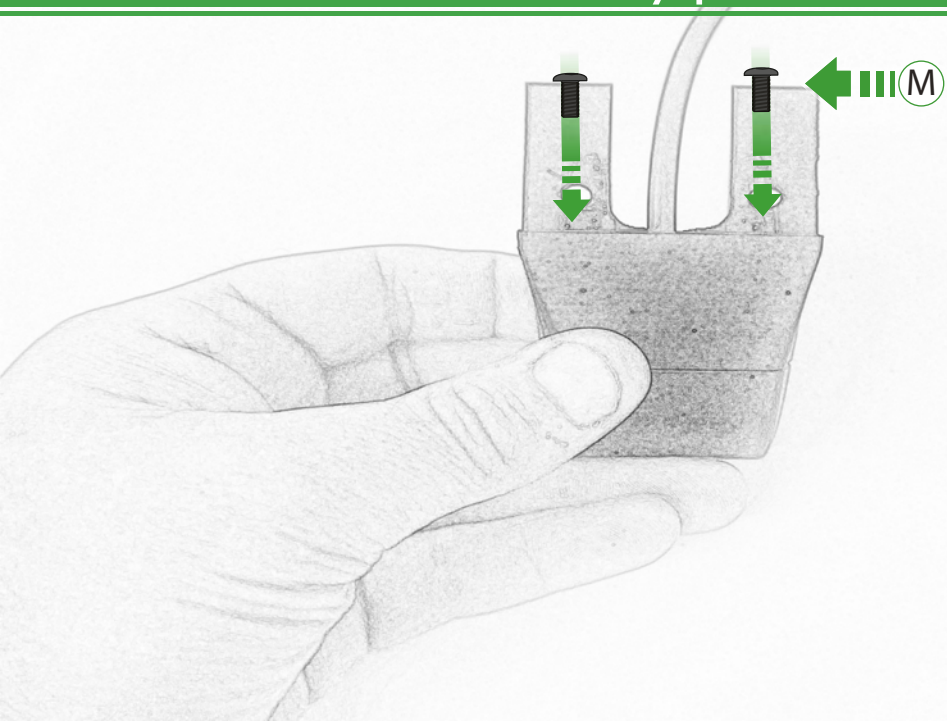

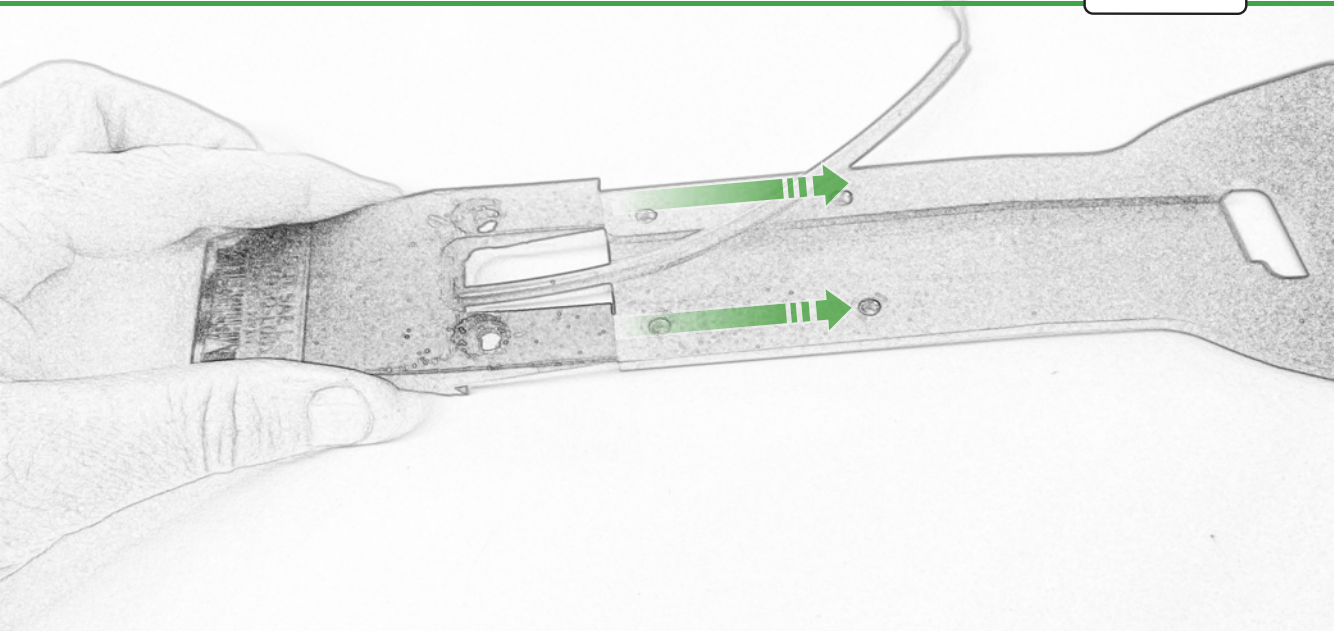

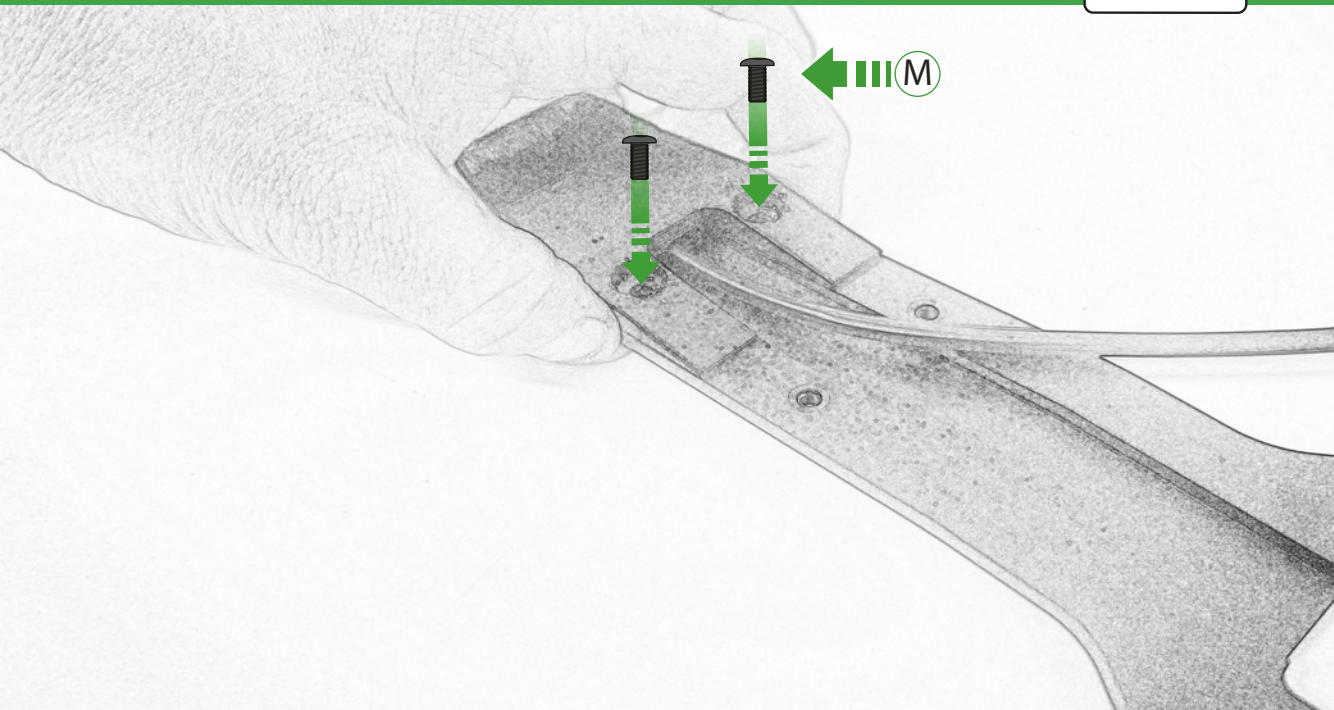

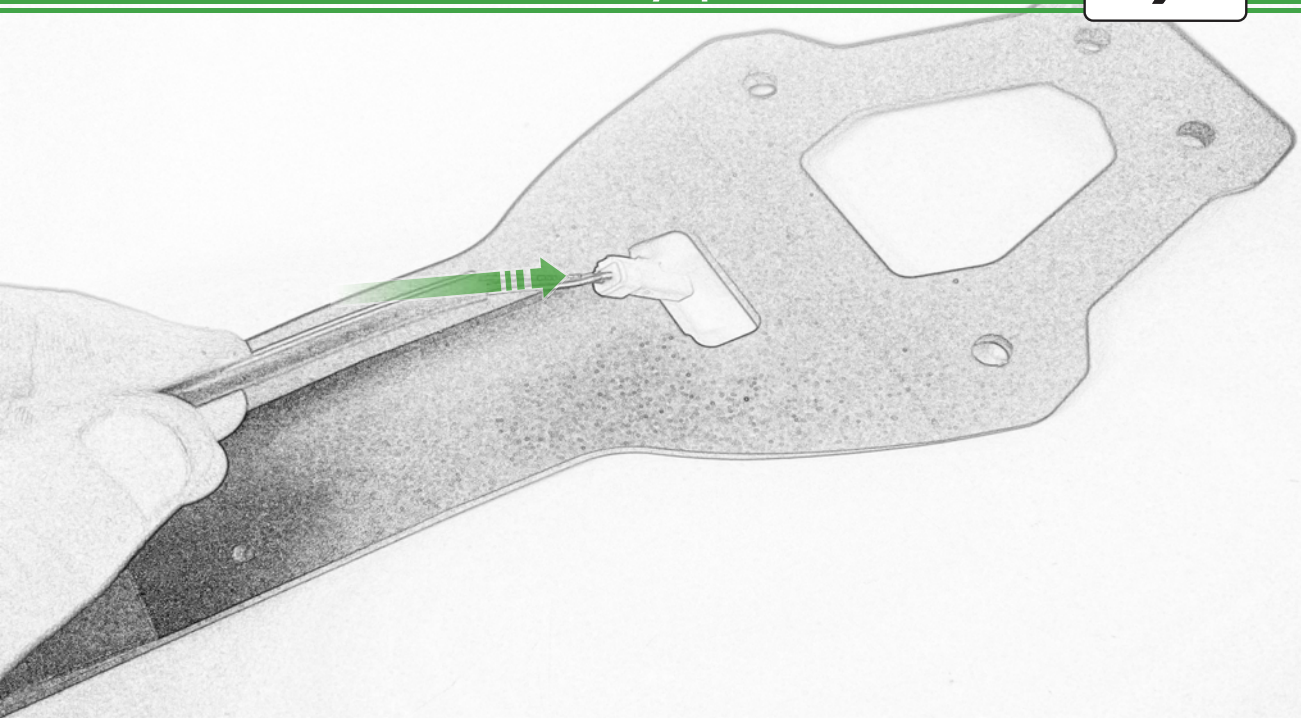

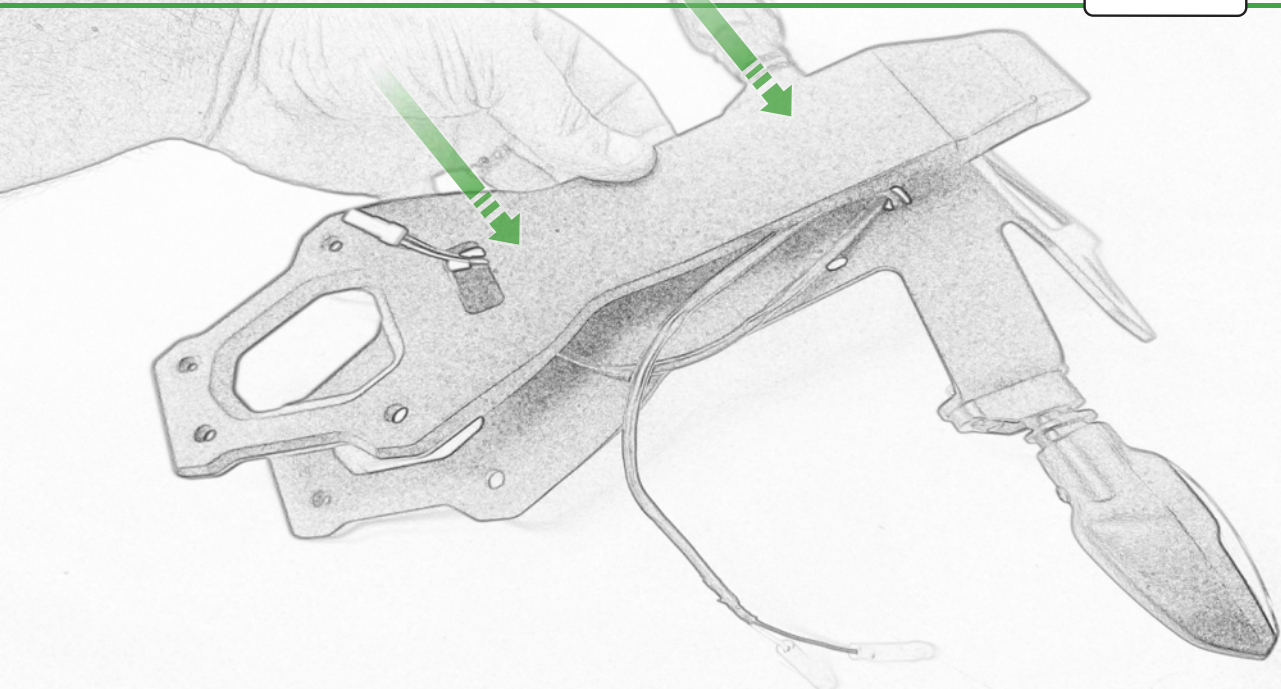

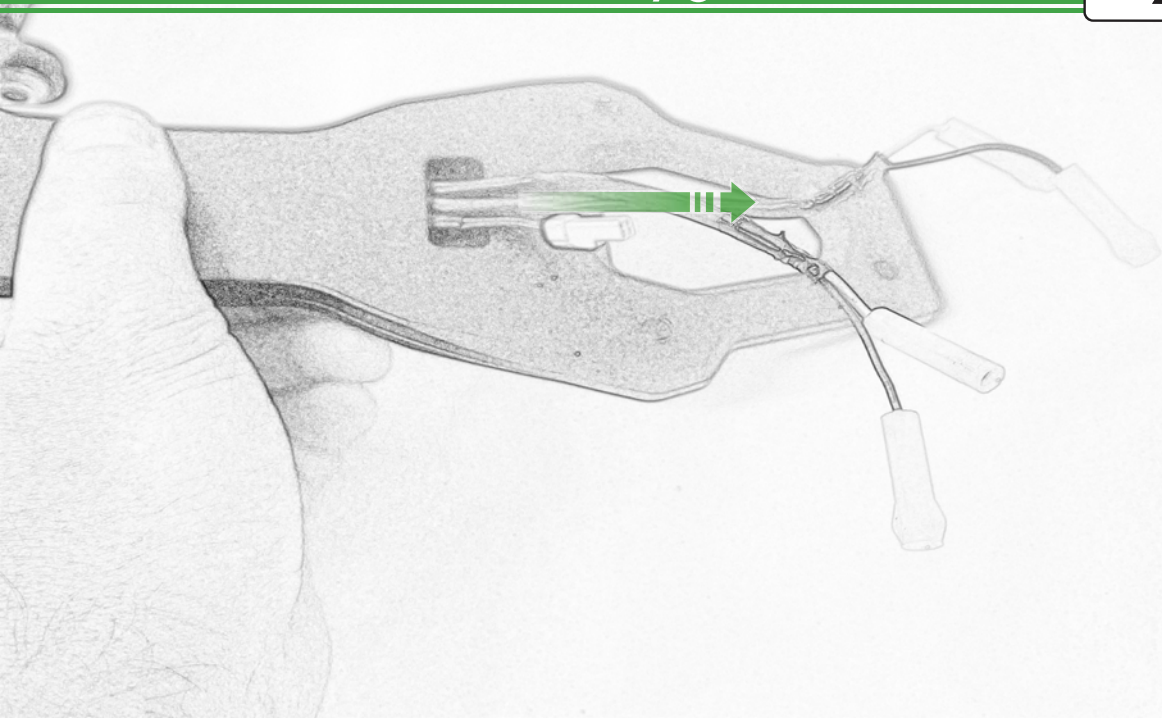

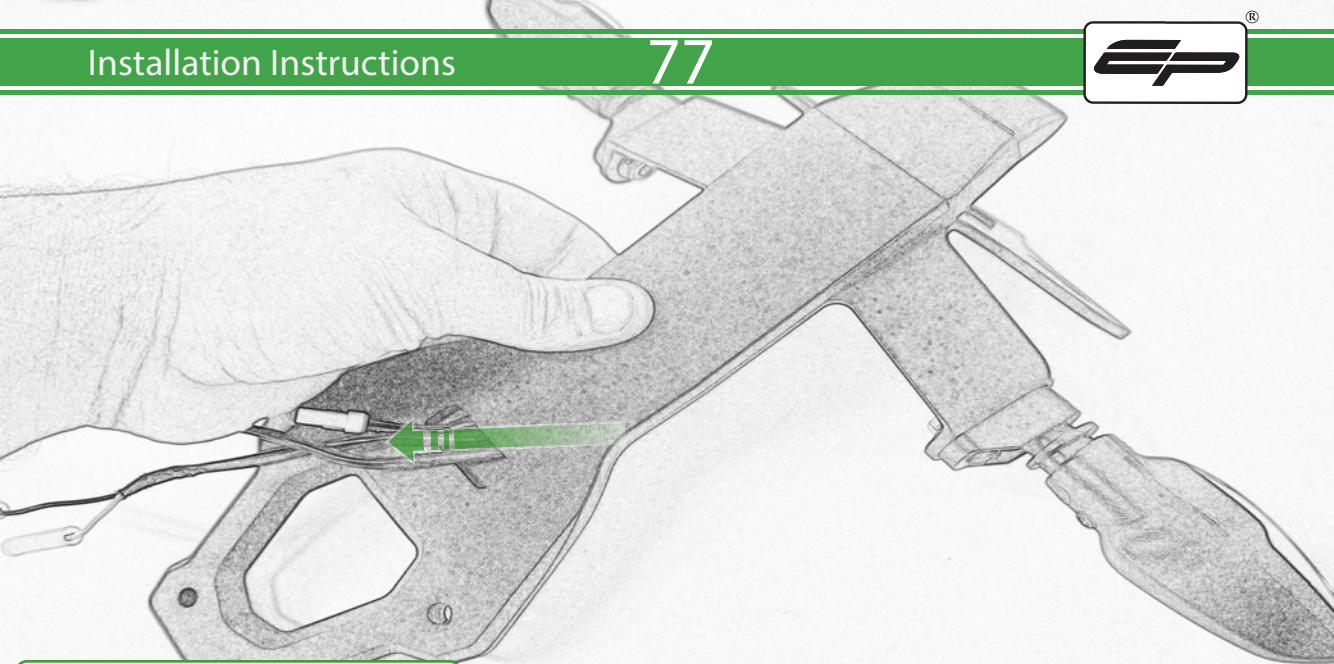

Caution

Run wires neatly down the channel in both parts ensuring they do not get trapped or squashed

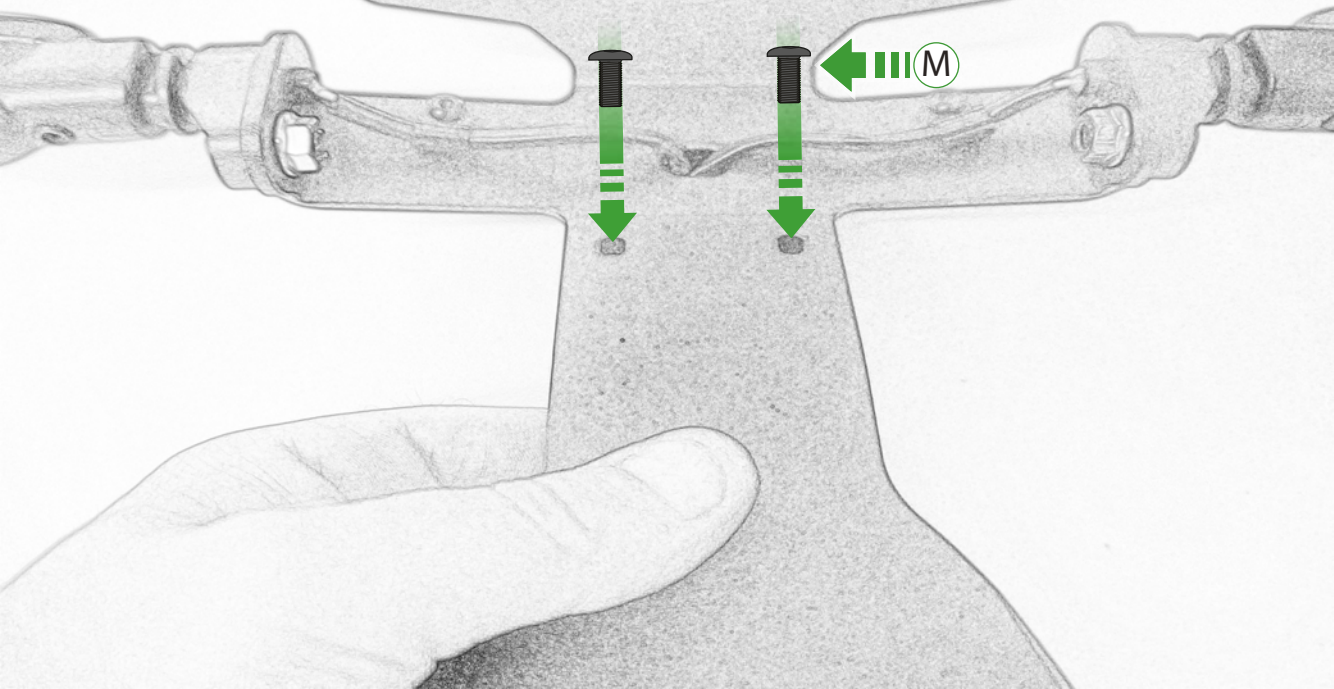

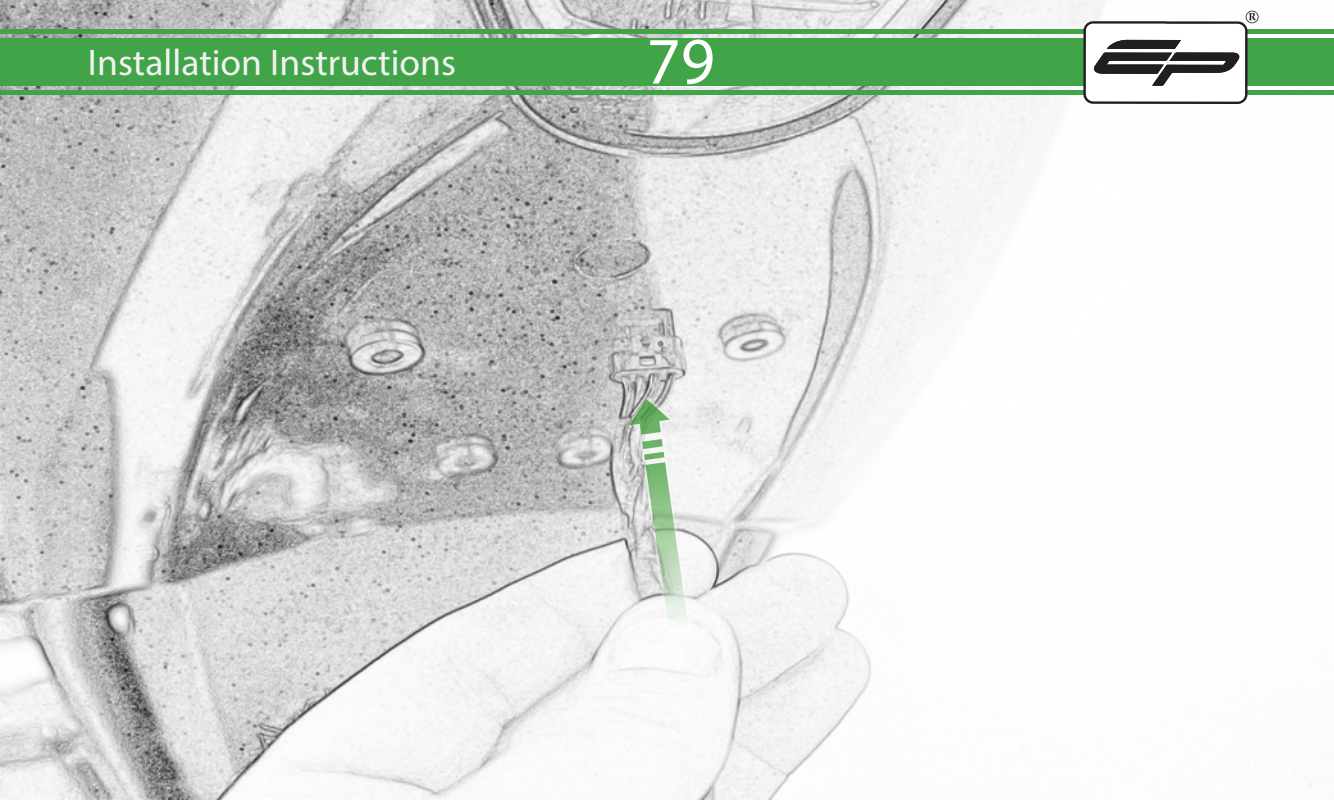



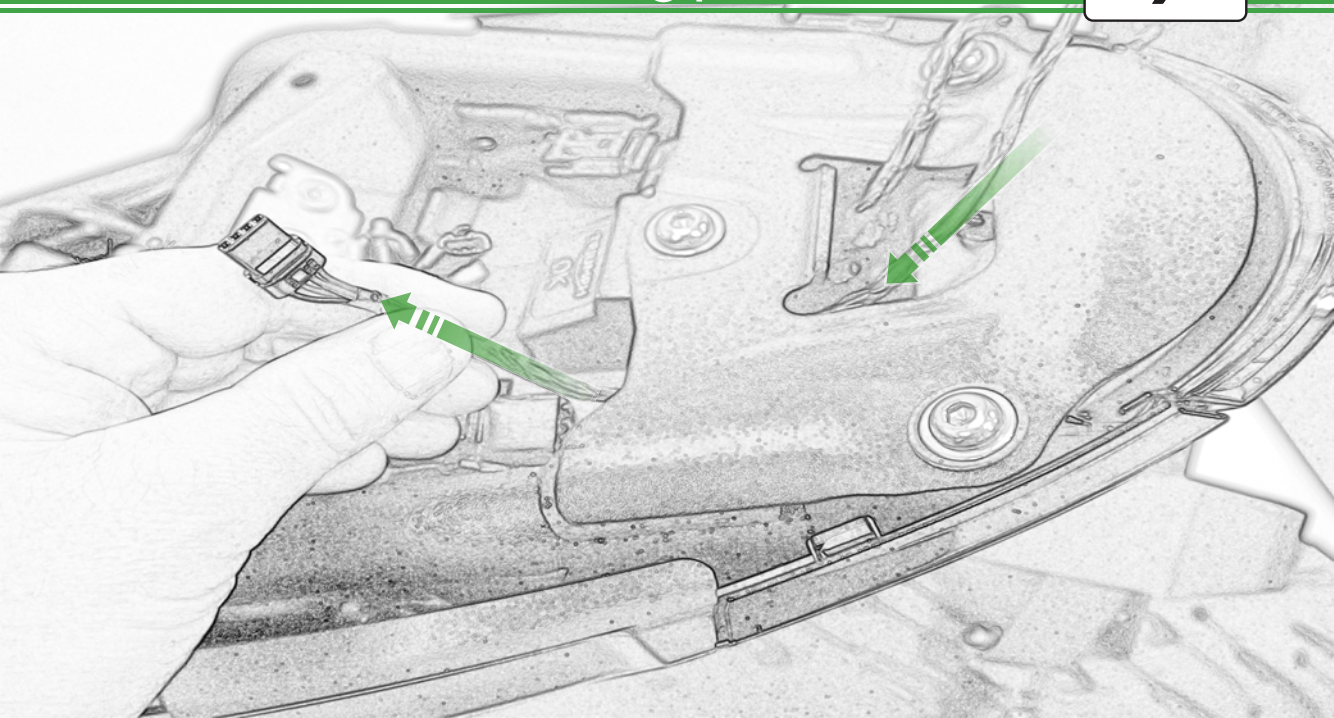

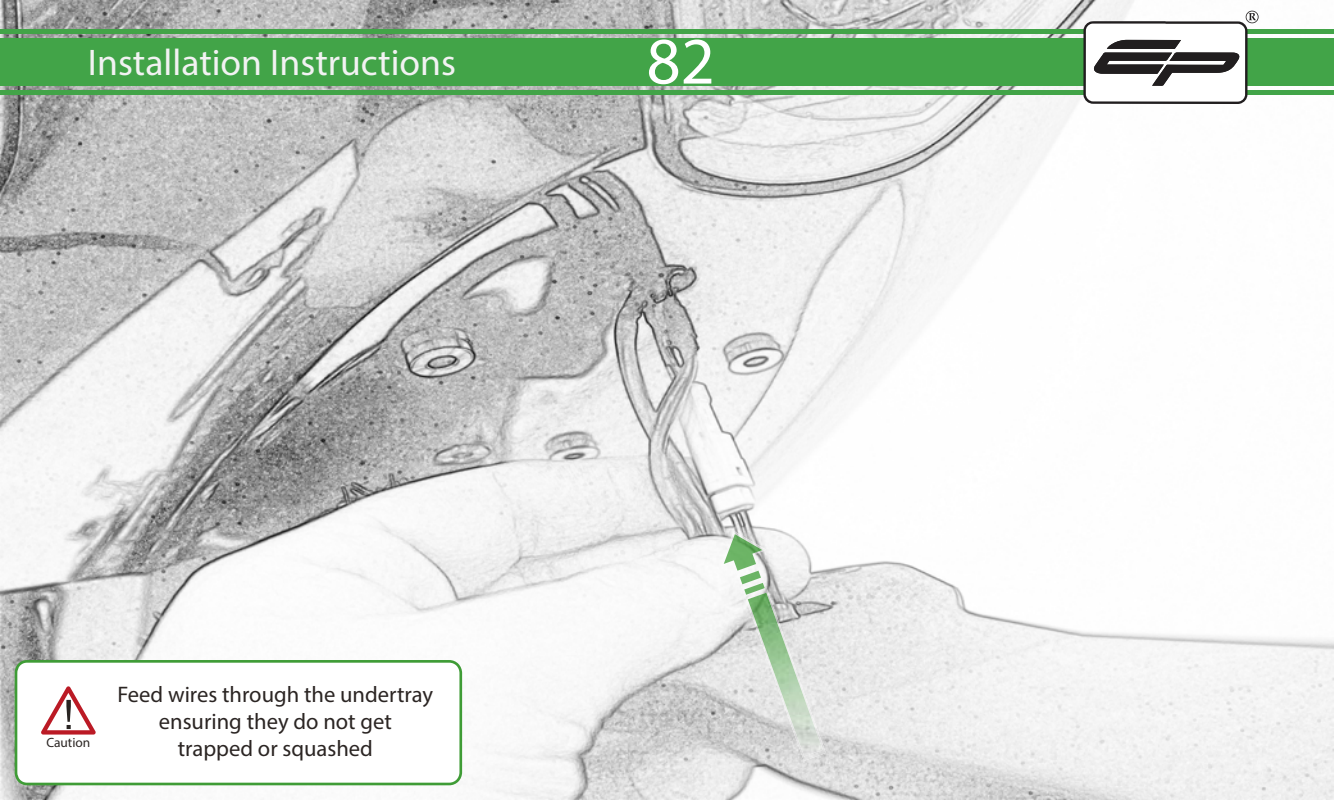

Caution

Feed wires through the undertray ensuring they do not get trapped or squashed

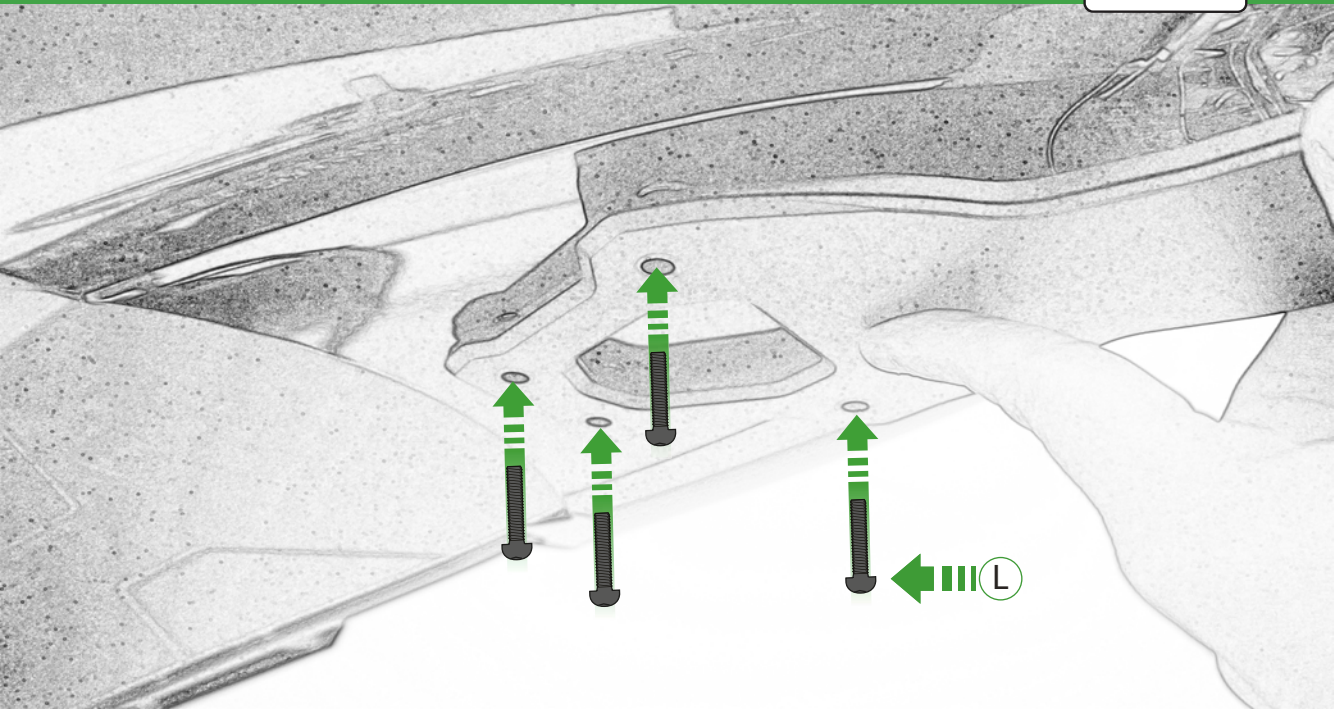

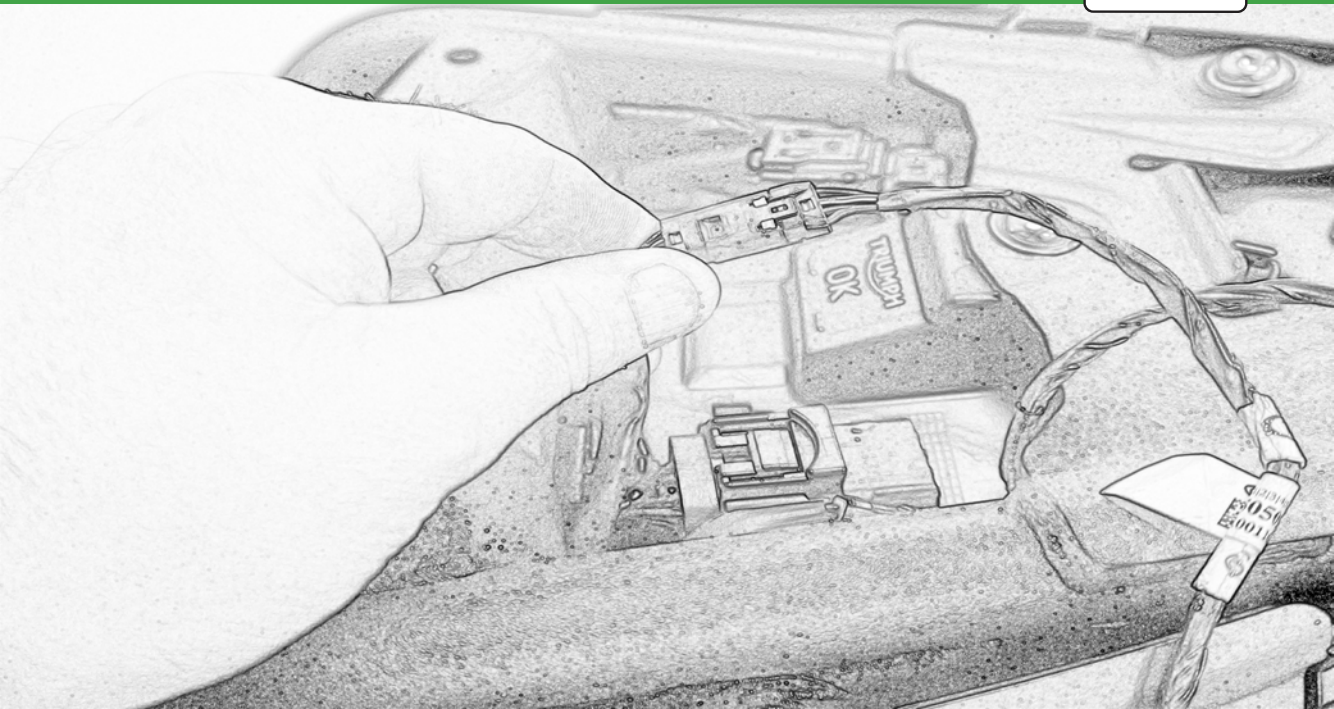

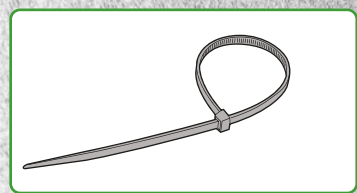

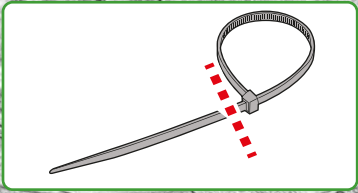



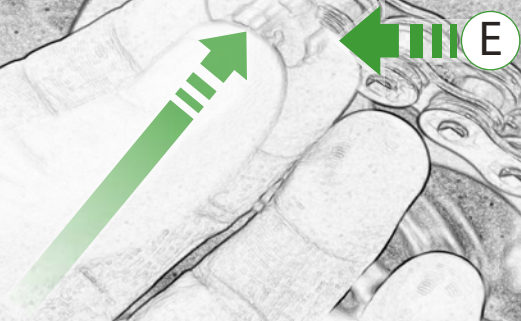

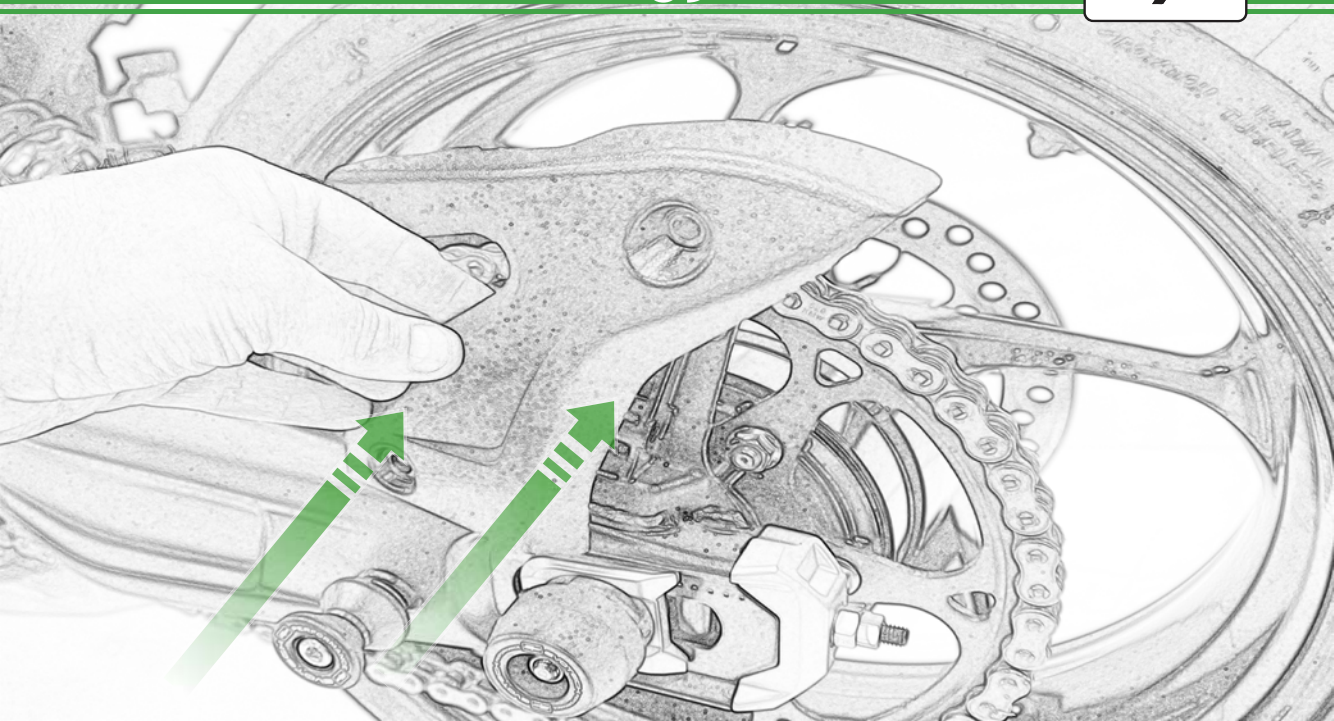

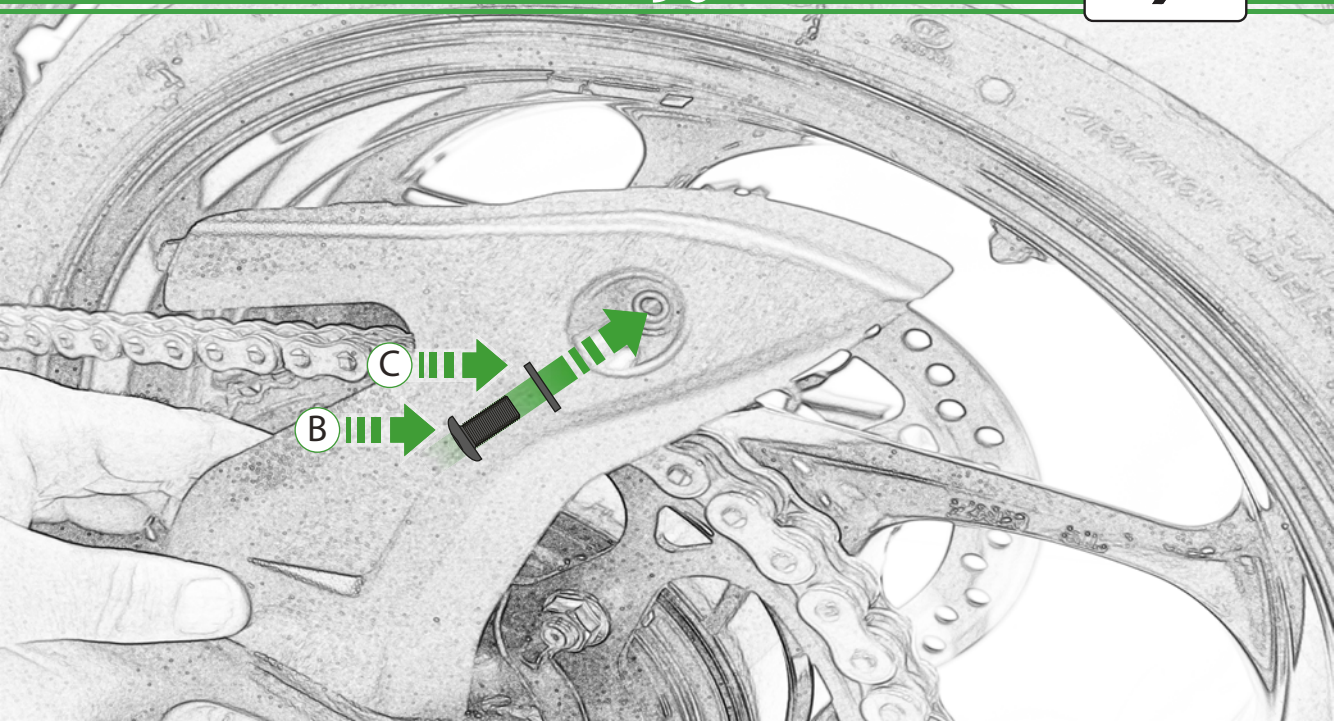

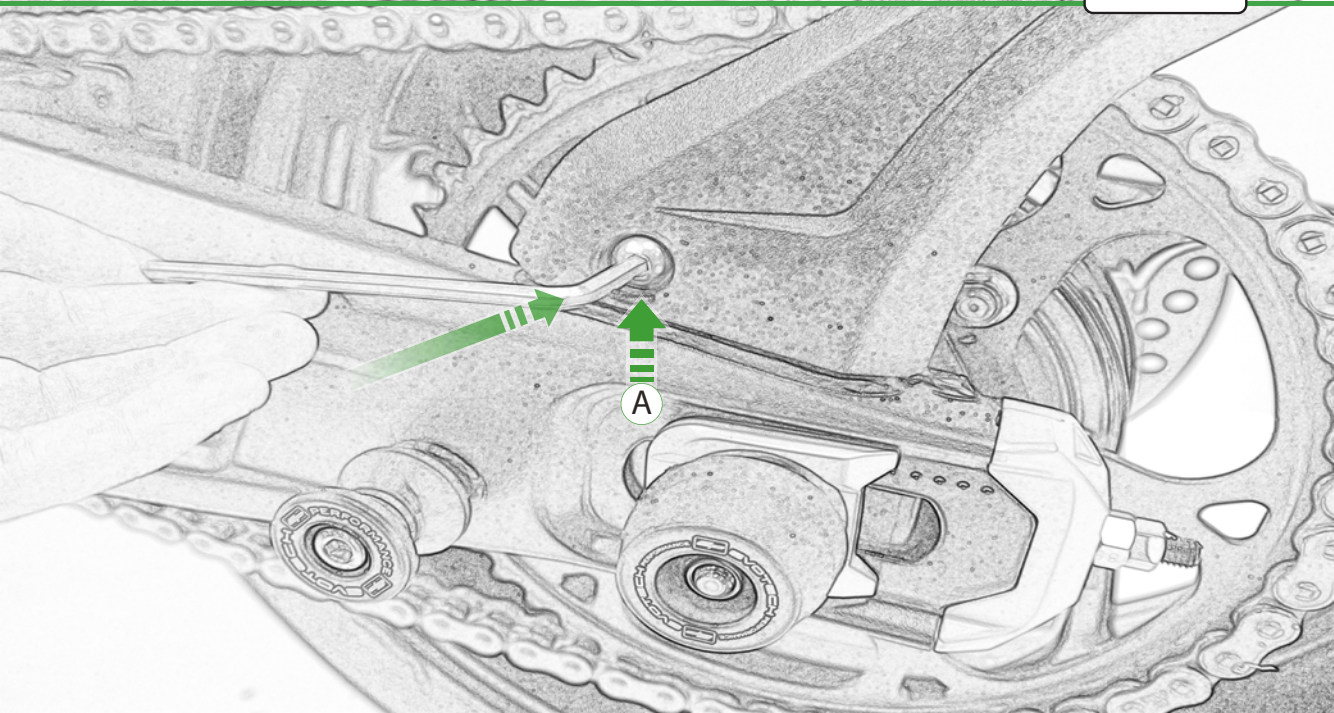



Reverse Stages

31 - 28



Reverse Stages

43 - 41

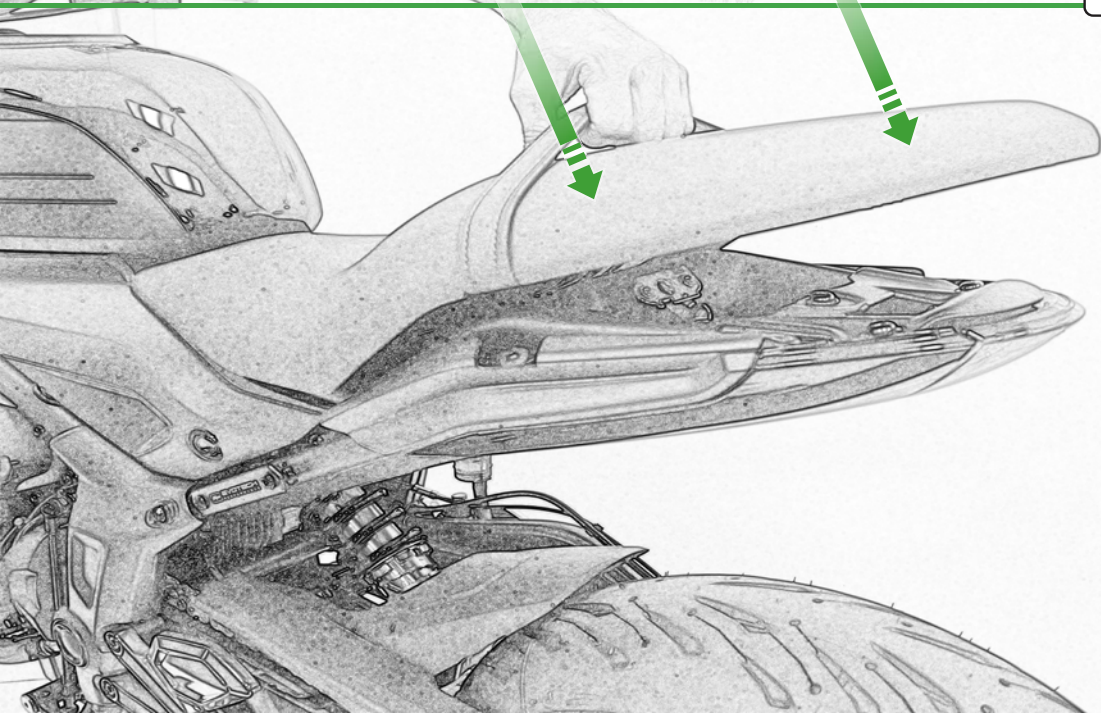



ESSENTIAL CHECKS



After installation of your tail tidy ensure that the licence plate does not contact the rear tyre when suspension is fully compressed.

Ensure all electrics including indicators, tail light, brake light and licence plate light lights are working correctly before riding the motorcycle.

It is recommended that periodic inspections are made to ensure that all fixings are fully tightend.

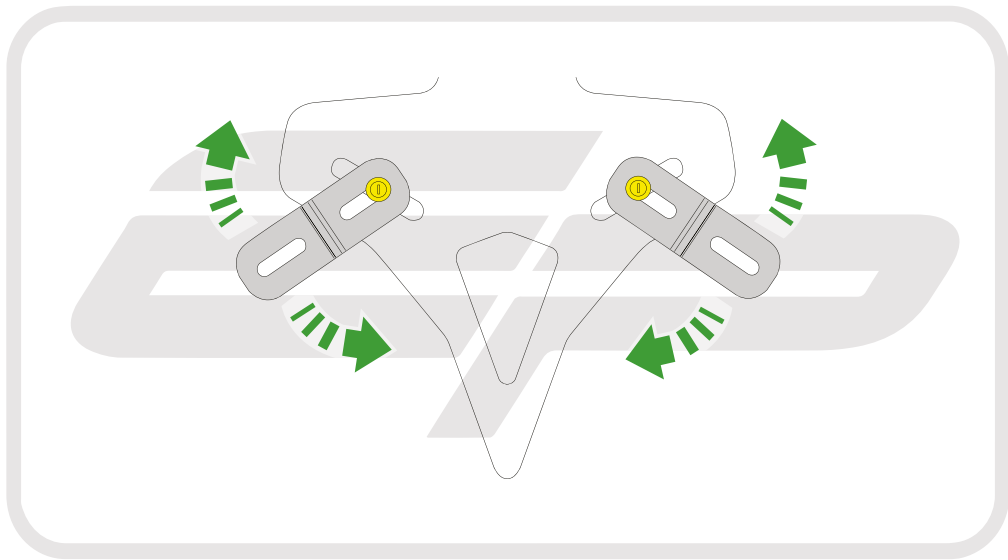

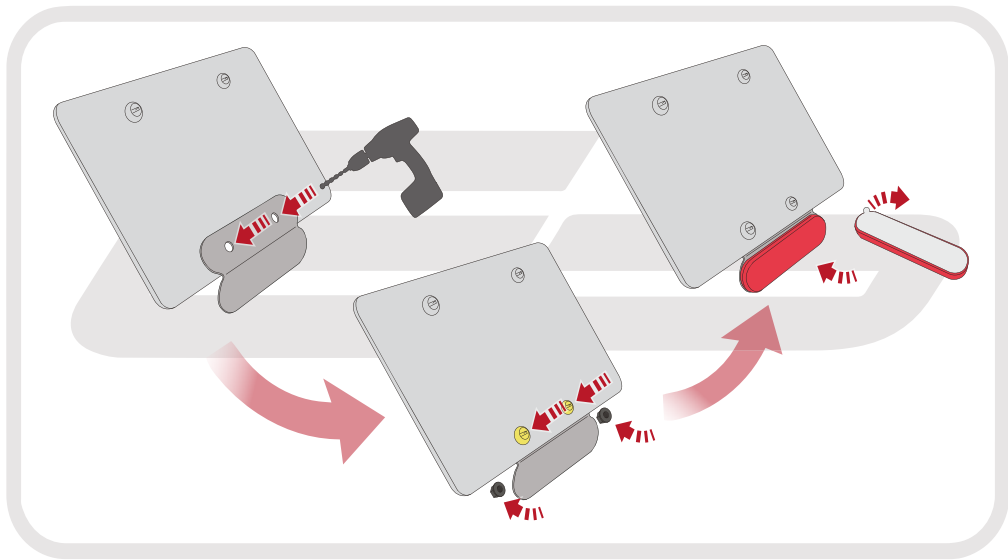



EVOTECH®
P E R F O R M A N C E

www.evotech-performance.com