



EVOTECH®
P E R F O R M A N C E

www.evotech-performance.com

Garmin Sat Nav Bar Clamp
Mount Instruction



Kit Contents PRN014566-015147

- Ⓐ 1 x Upper Mounting Body
- Ⓑ 1 x Lower Mounting Body
- Ⓒ 1 x Mounting Plate
- Ⓓ 1 x Garmin Mounting Plate
- Ⓔ 2 x Spacer
- Ⓕ 2 x M4 x 25mm Caphead Bolts
- Ⓖ 2 x O-ring
- Ⓗ 2 x M5 x 8mm Black Button Head Bolts
- Ⓘ 4 x M4 x 10mm Black Button Head Bolts



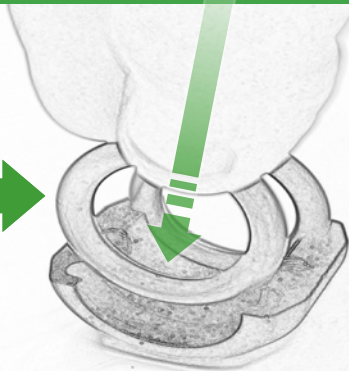

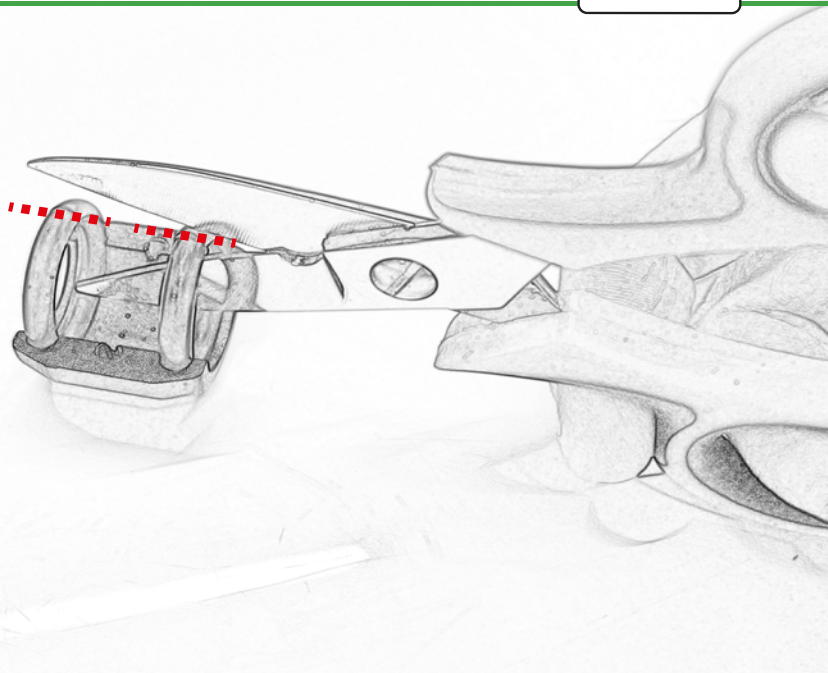

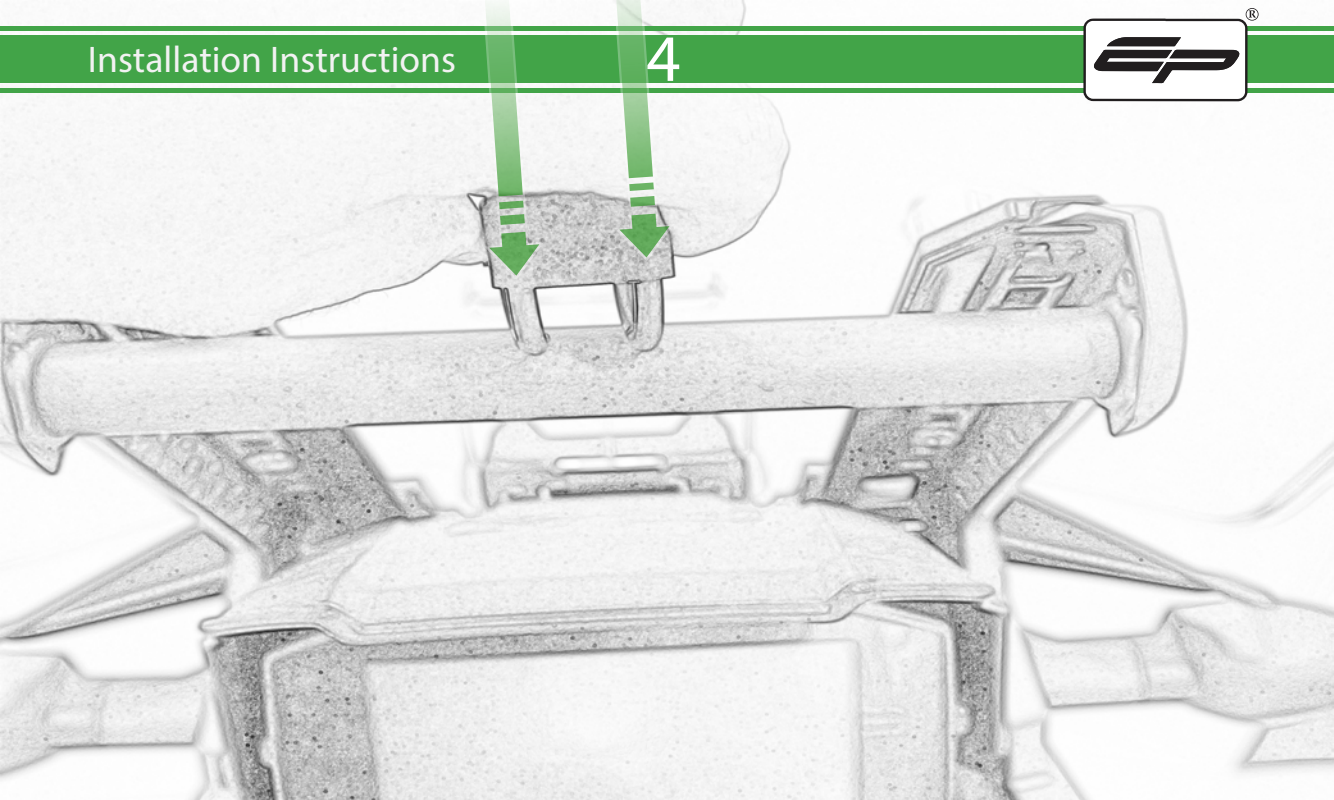



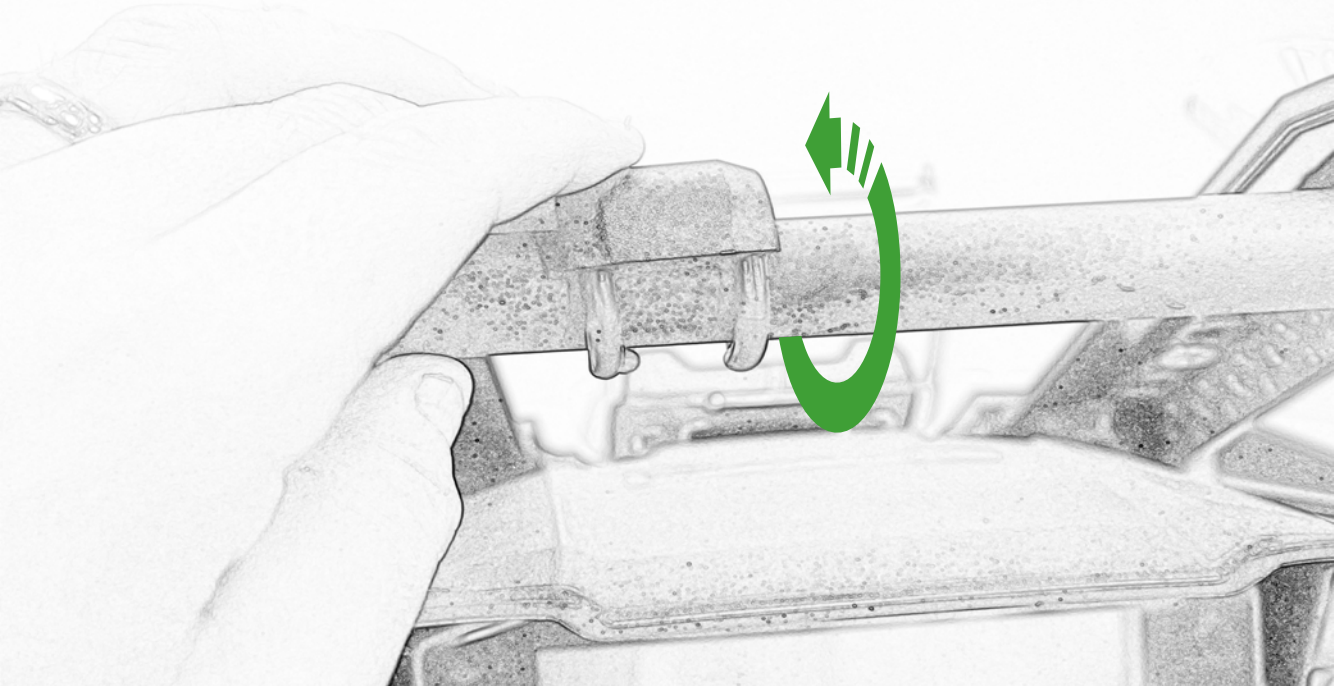

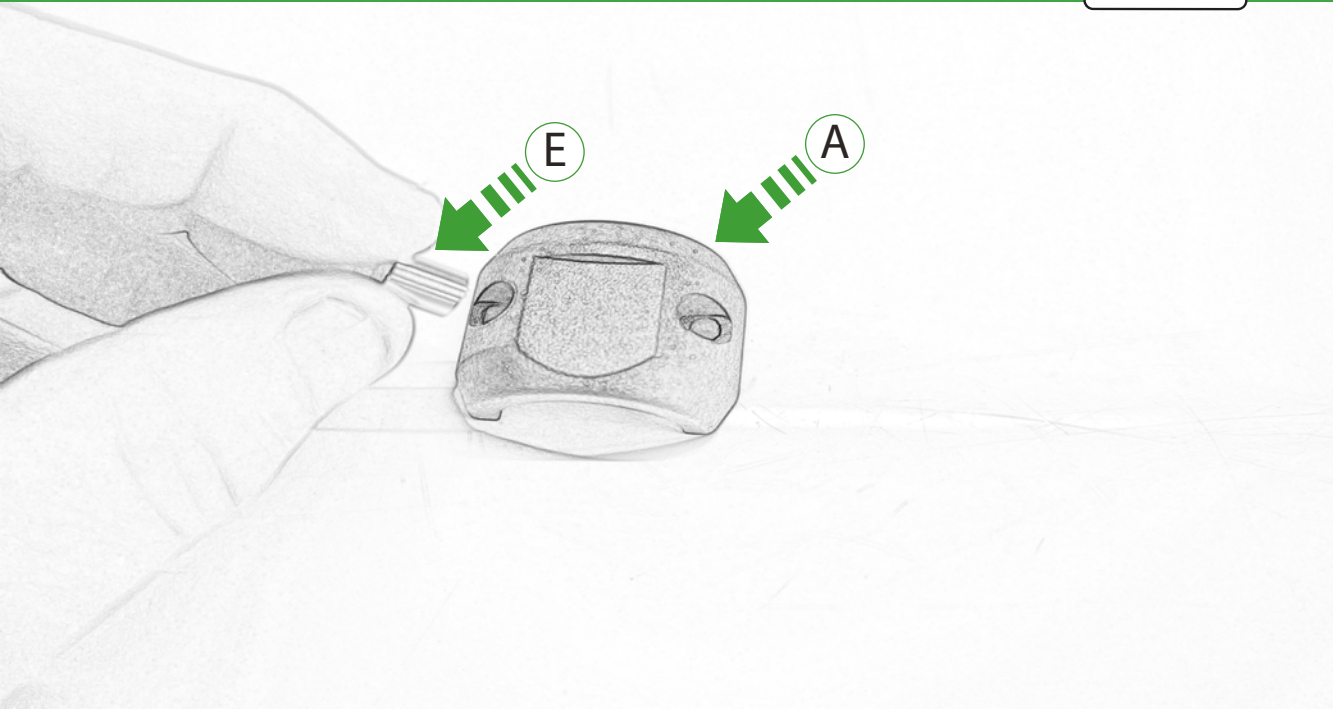

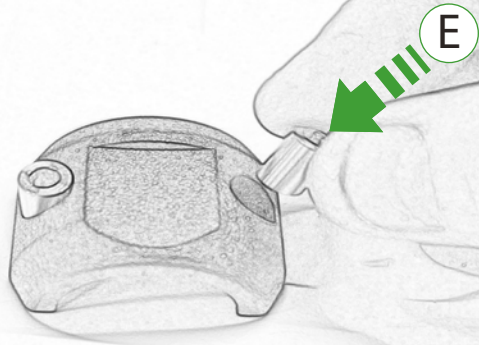

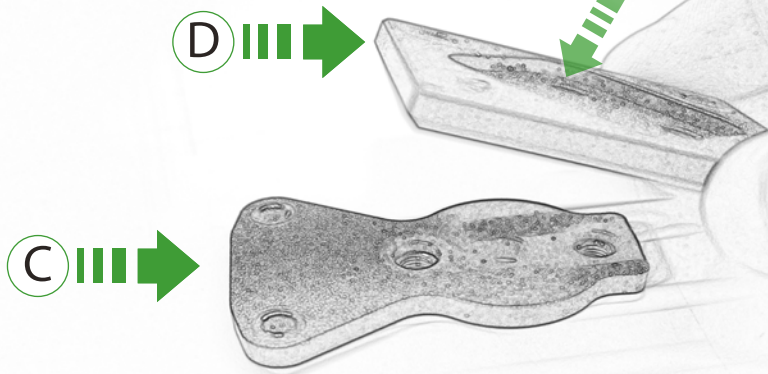

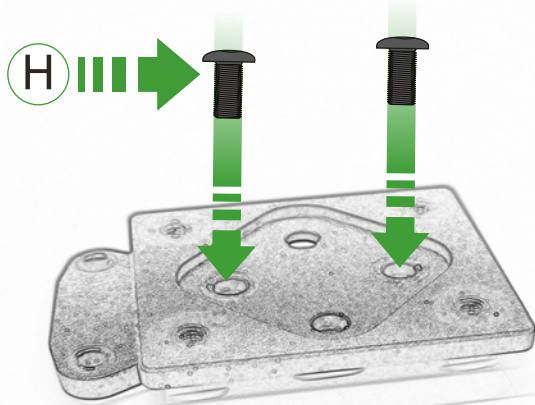

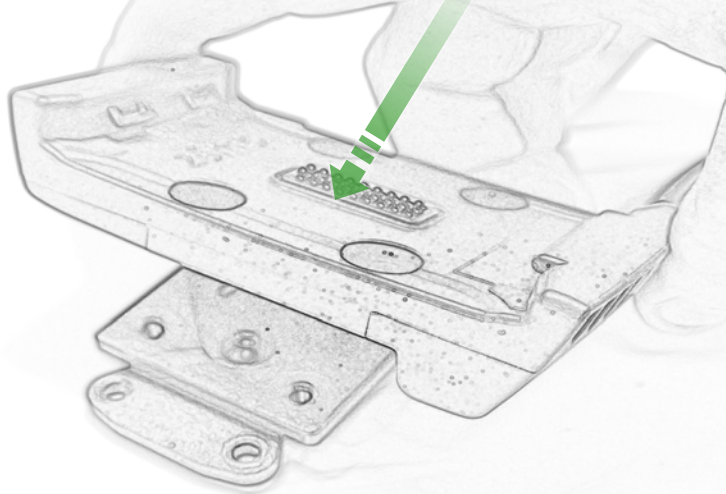

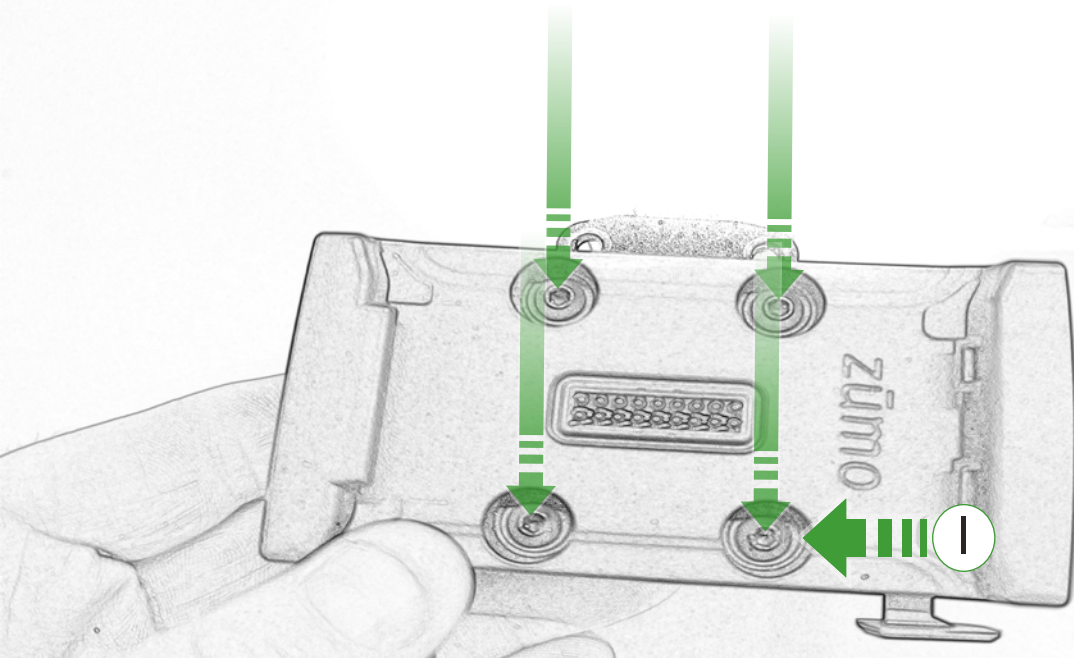

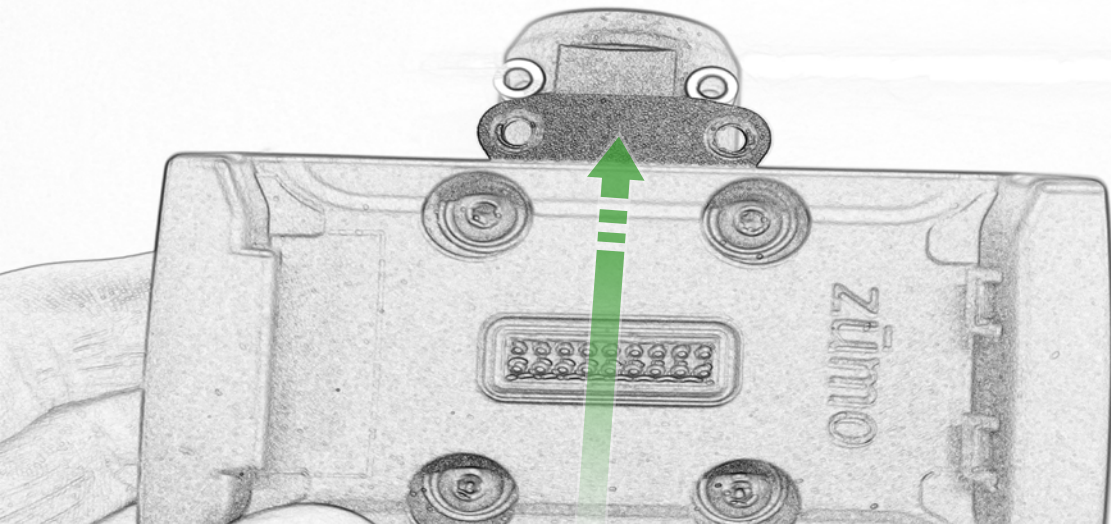

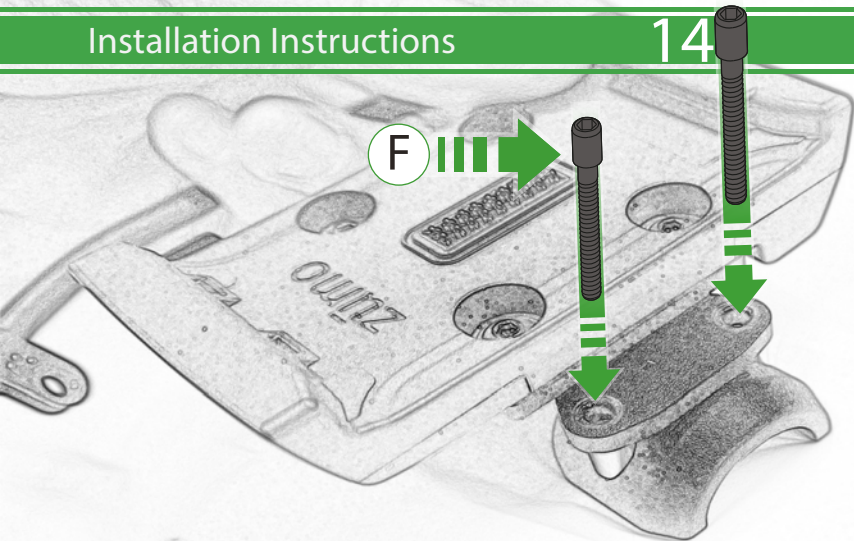

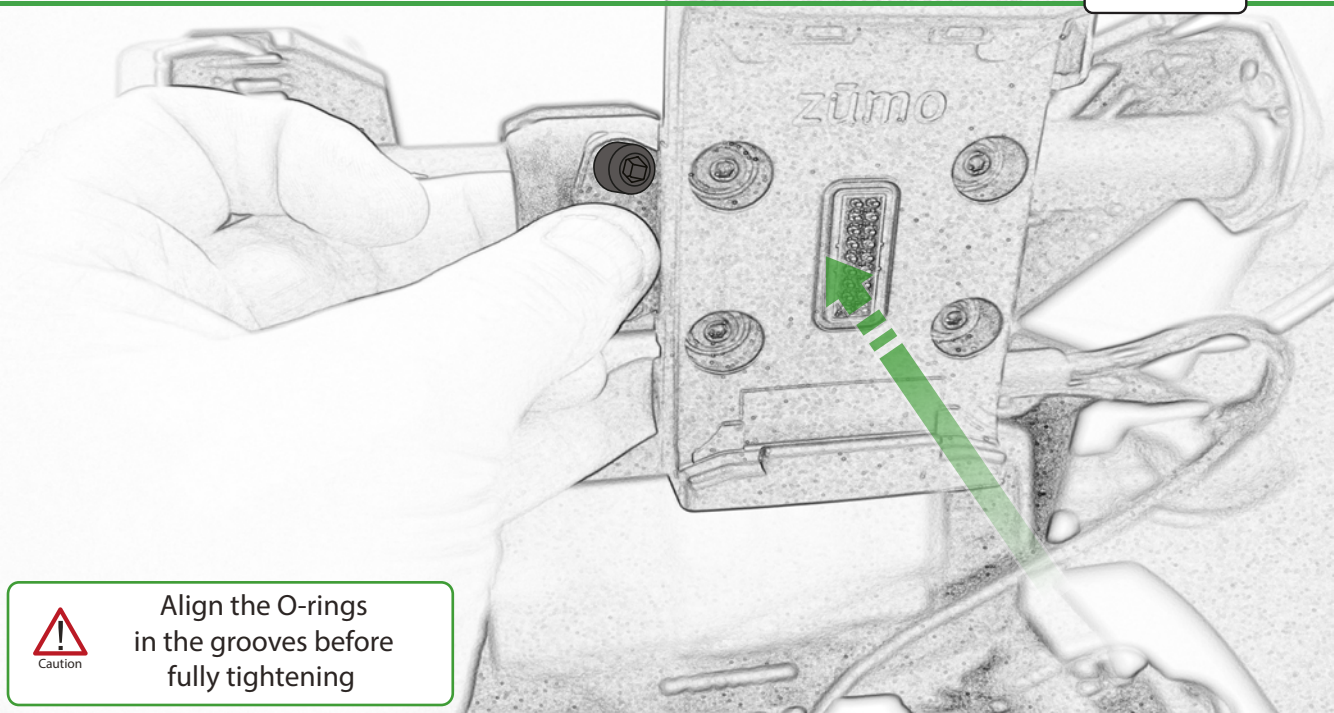

Caution

Align the O-rings
in the grooves before
fully tightening

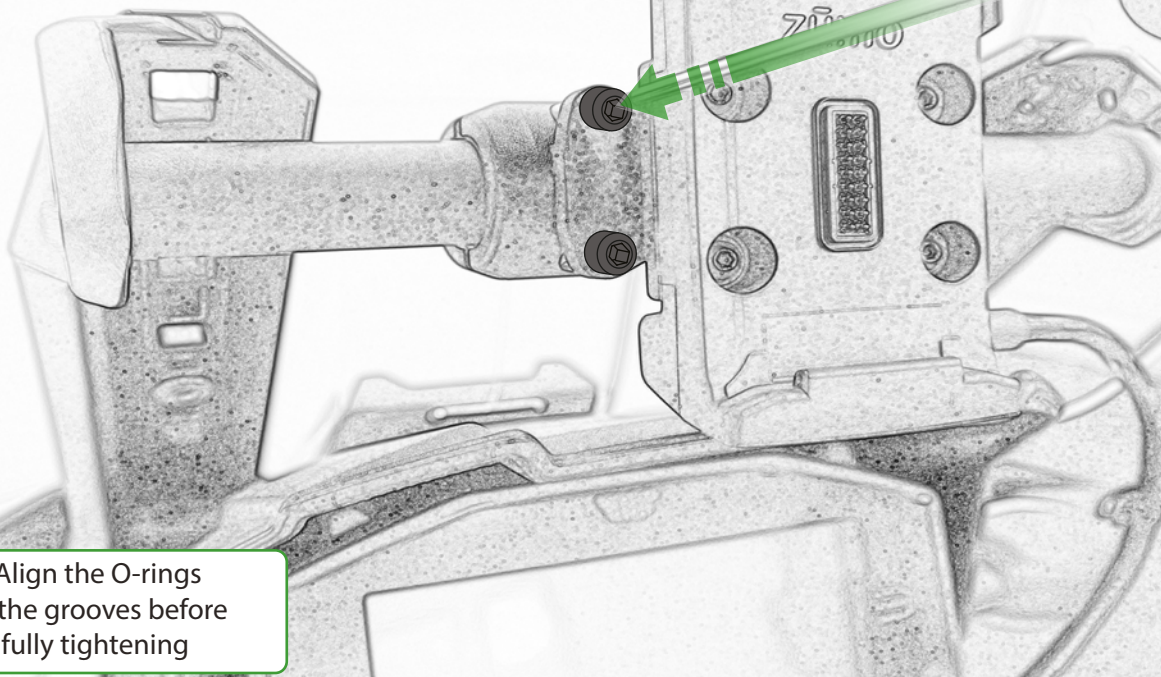

Caution

Align the O-rings
in the grooves before
fully tightening

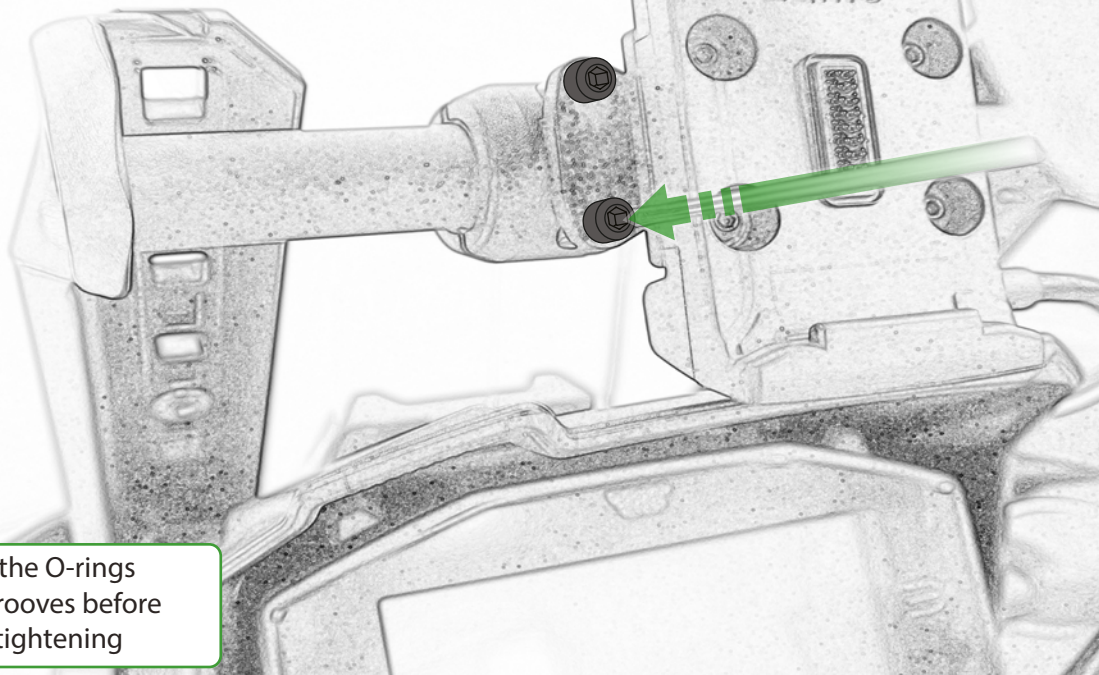

Caution

Align the O-rings
in the grooves before
fully tightening



ESSENTIAL CHECKS

It is recommended that periodic inspections are made to ensure that all bolts are tightened to the specified torque settings.

Should the bike be involved in an accident a thorough inspection should be made and any components that have taken an impact, no matter how small, be replaced



EVOTECH®
P E R F O R M A N C E

www.evotech-performance.com