



**EVOTECH**®  
P E R F O R M A N C E

BMW F900 XR / TE

Garmin Sat Nav Mount

Installation Instructions



## Kit Contents PRN014566-015019

- |                                    |   |
|------------------------------------|---|
| (A) 1 x Main Plate                 | (L) 2 x M4 x 5mm Black Button Head Bolts  |
| (B) 1 x Pivot Plate                | (M) 4 x M4 x 10mm Black Button Head Bolts |
| (C) 1 x Sub Mounting Bracket       | Sub Kit                                   |
| (D) 2 x M5 x 8mm Button Head Bolts | (N) 4 x M6 x 40 Caphead                   |
| (E) 2 x P-clips (No.1)             | (O) 4 x M5 x 10mm Button Head Bolts       |
| (F) 2 x P-clips (No.2)             |   |
| (G) 2 x P-clips (No.3)             |   |
| (H) 2 x P-clips (No.4)             |   |
| (I) 2 x Lobe Screw                 |   |
| (J) 2 x M5 Black Washer            |   |
| (K) 2 x Locking Washer             |   |

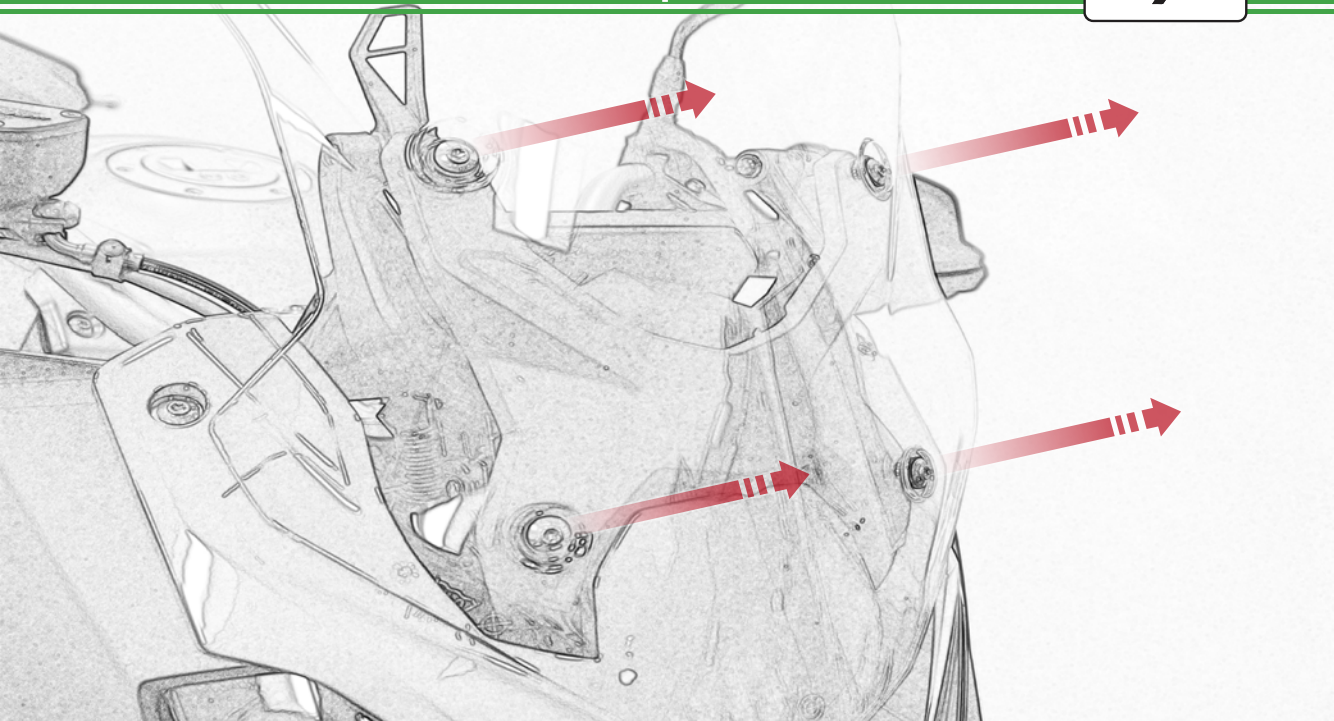





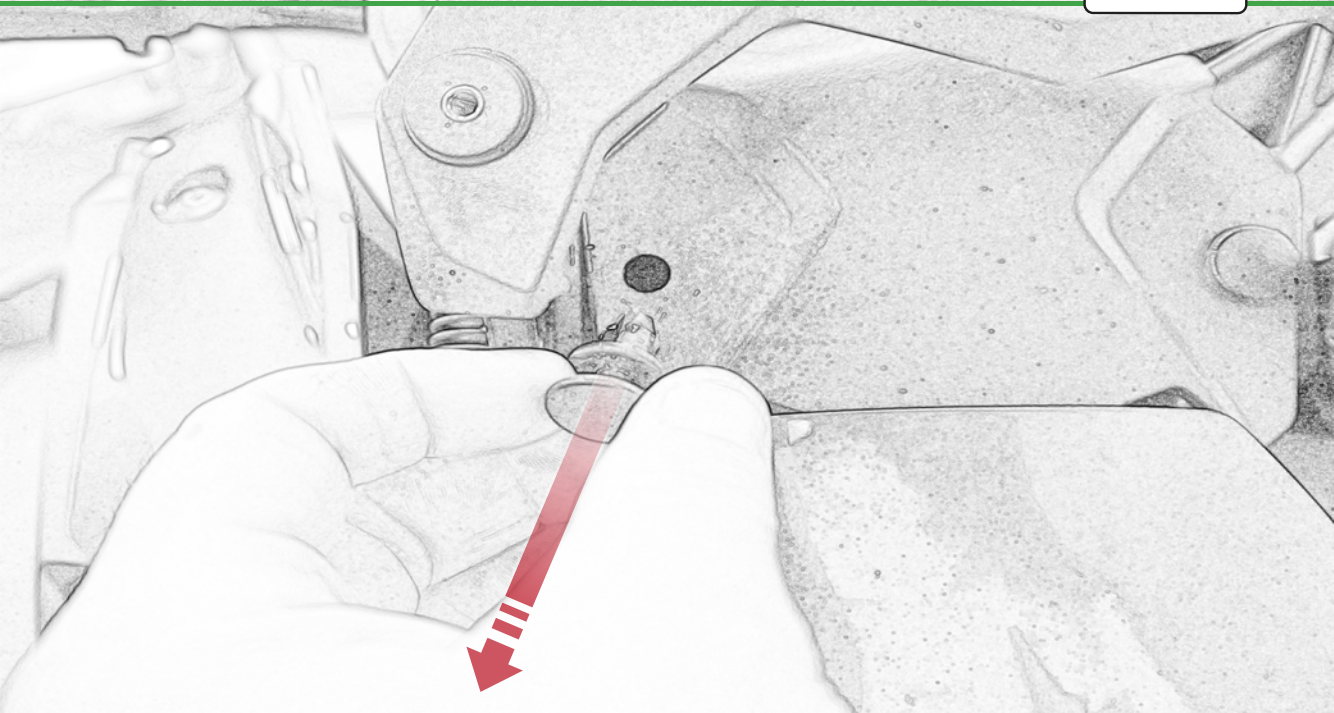

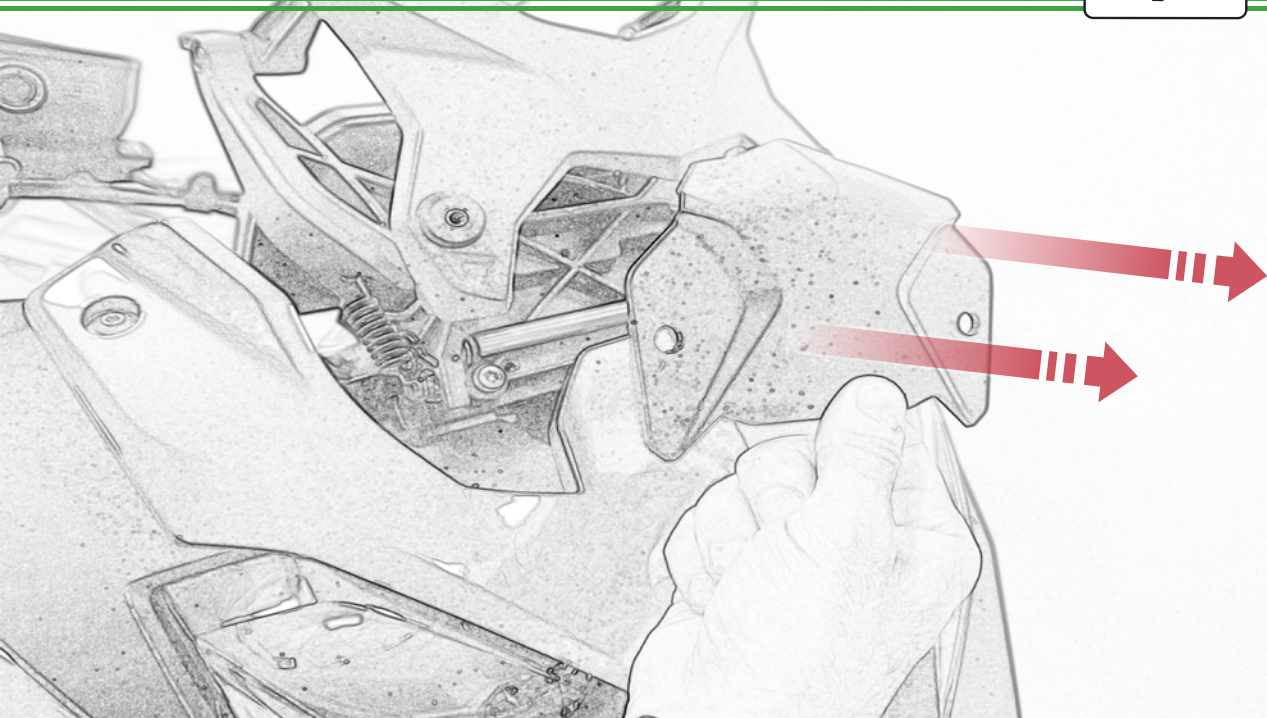

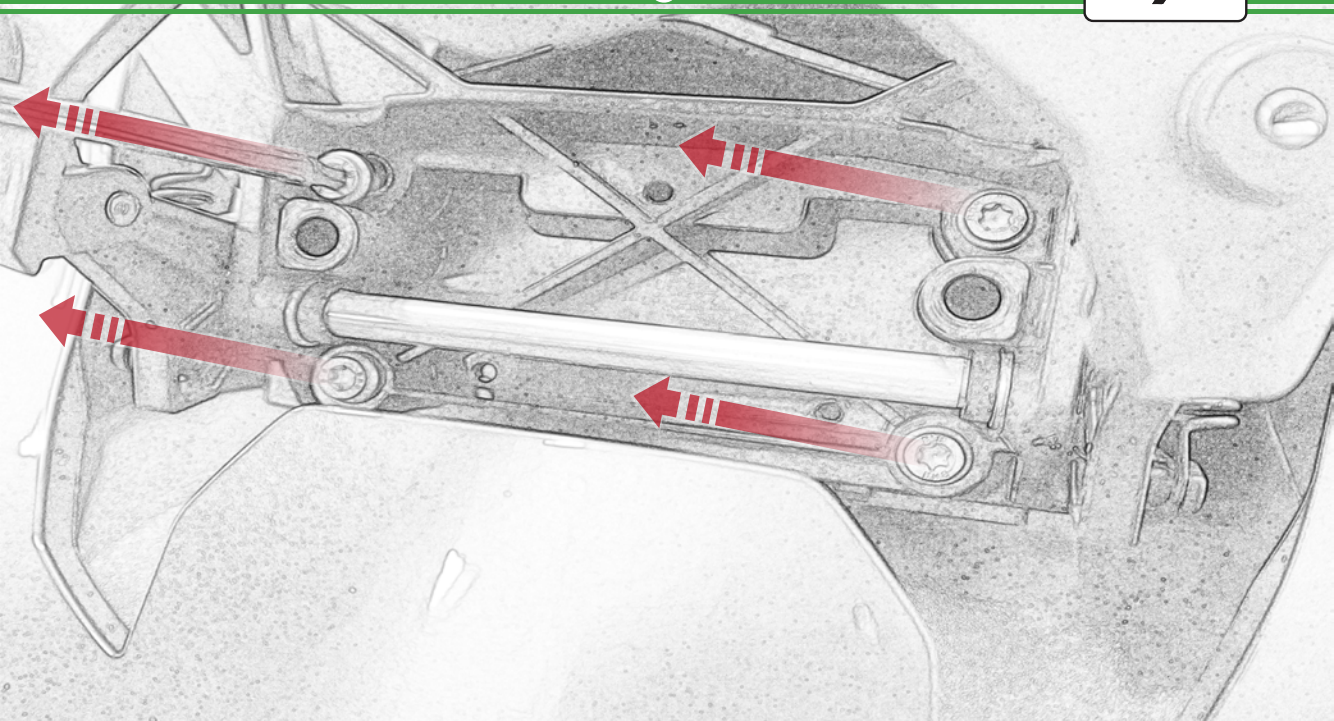



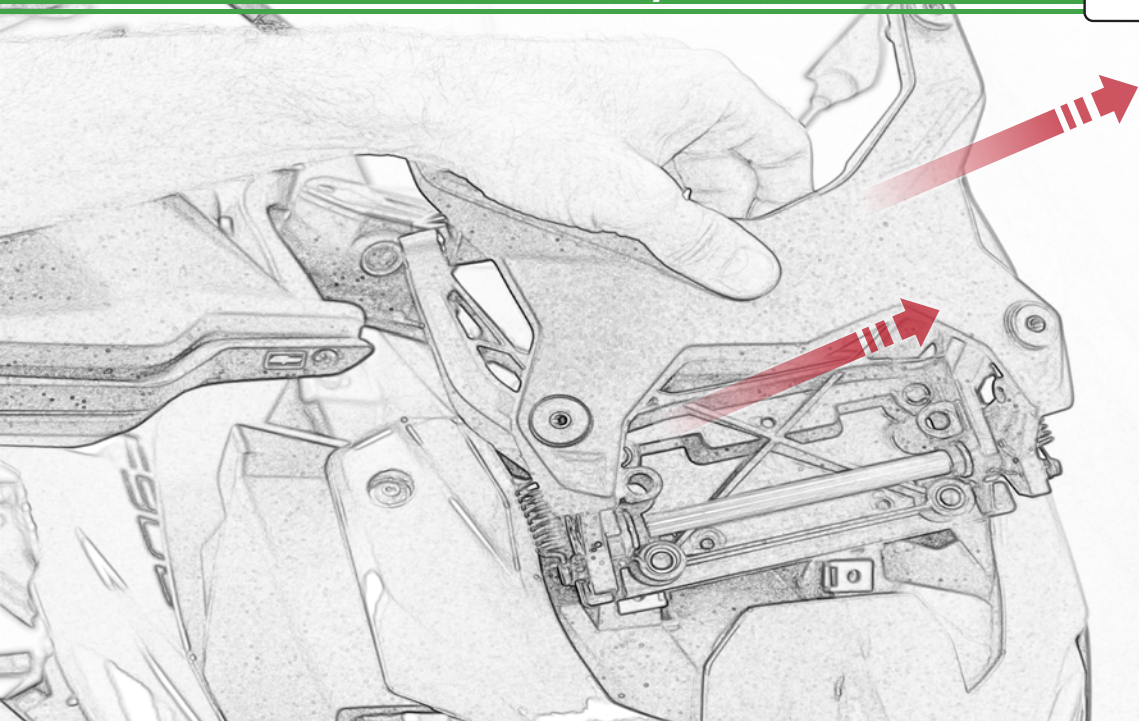

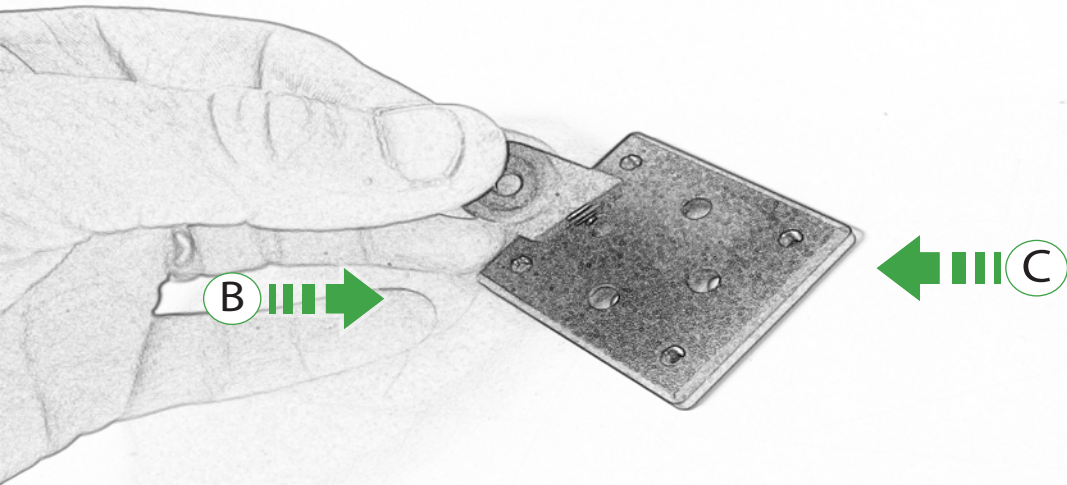

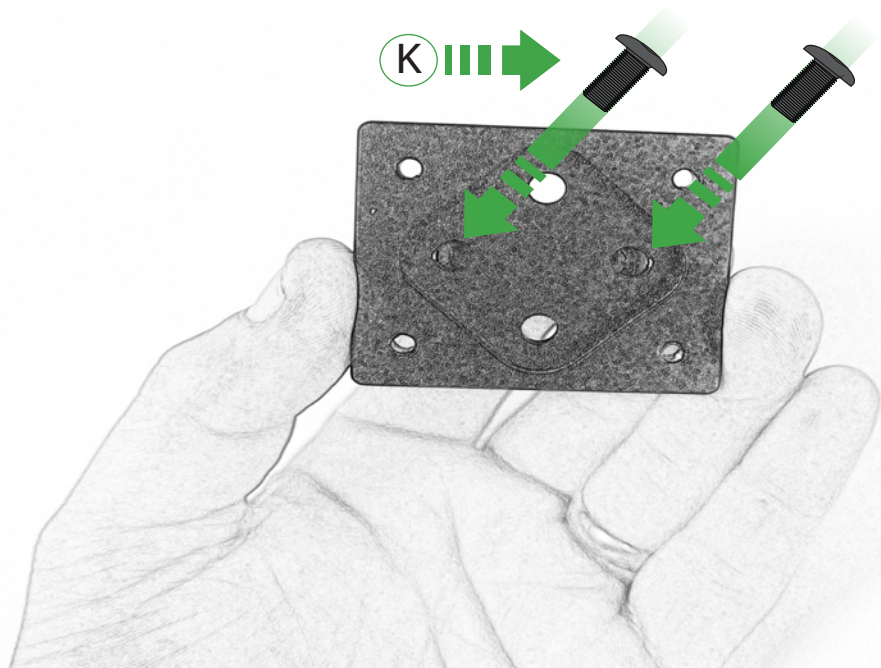

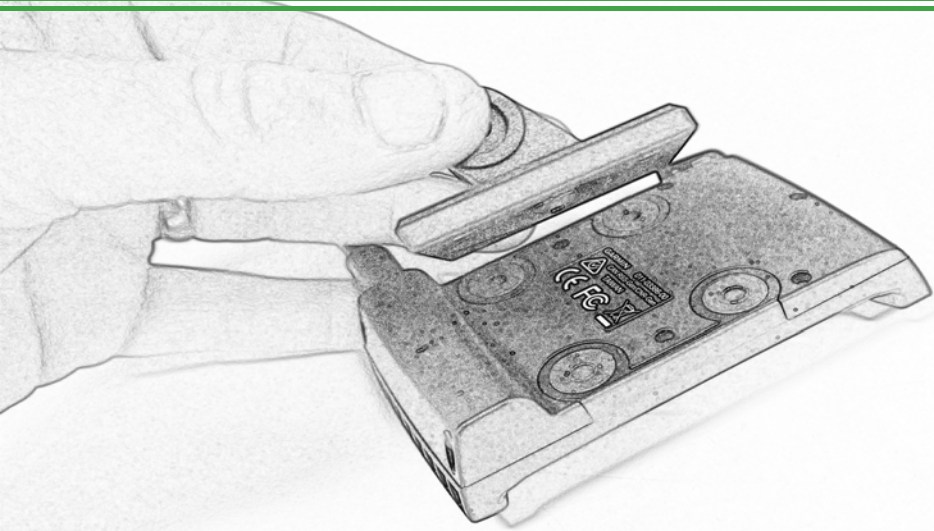

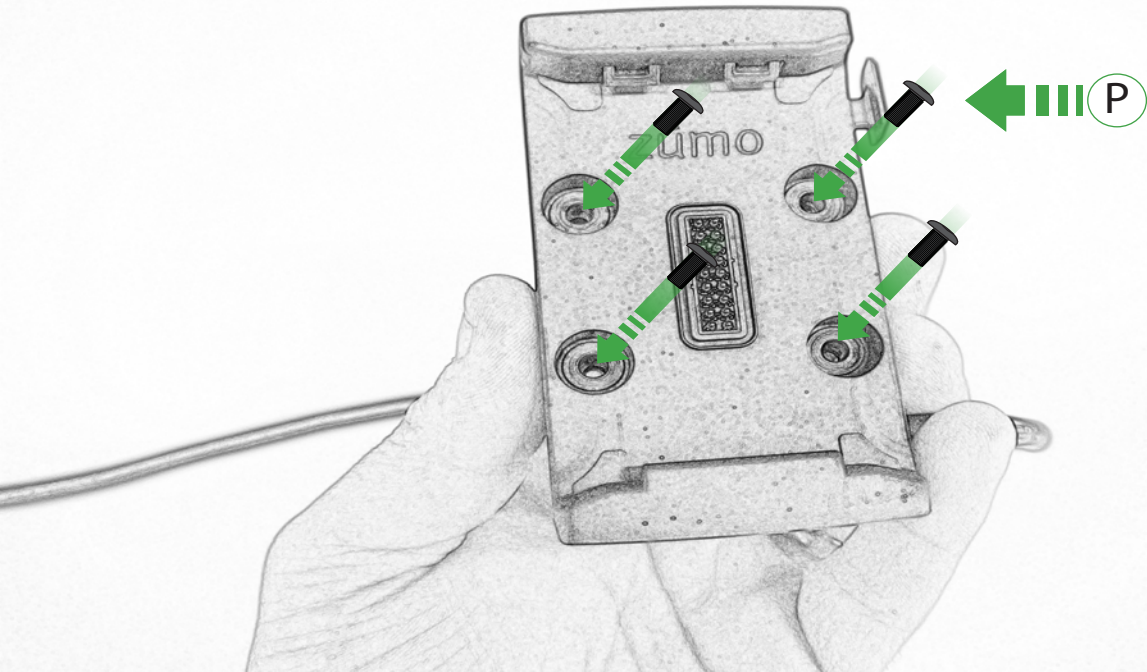

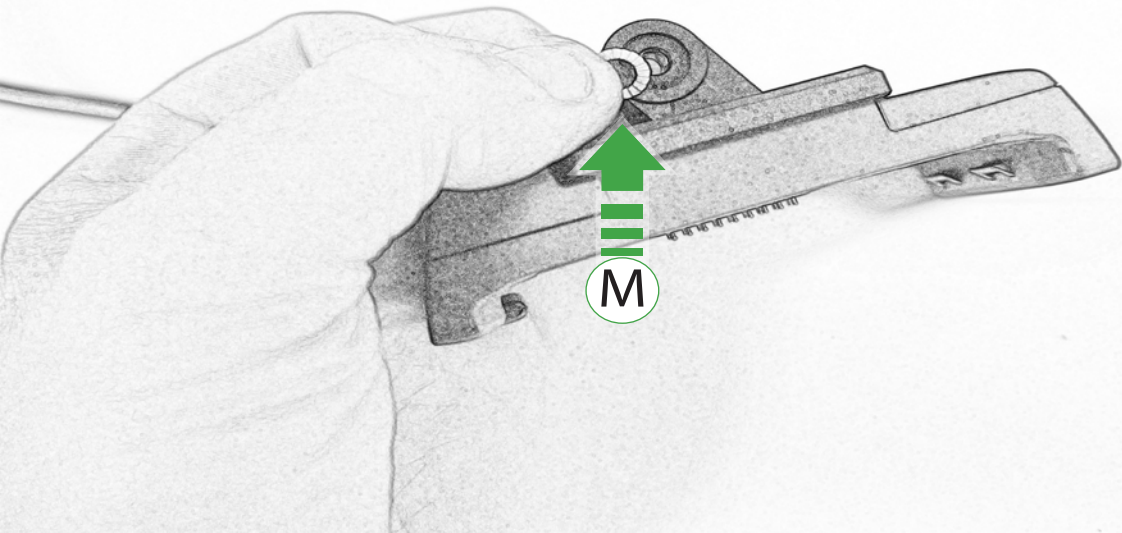

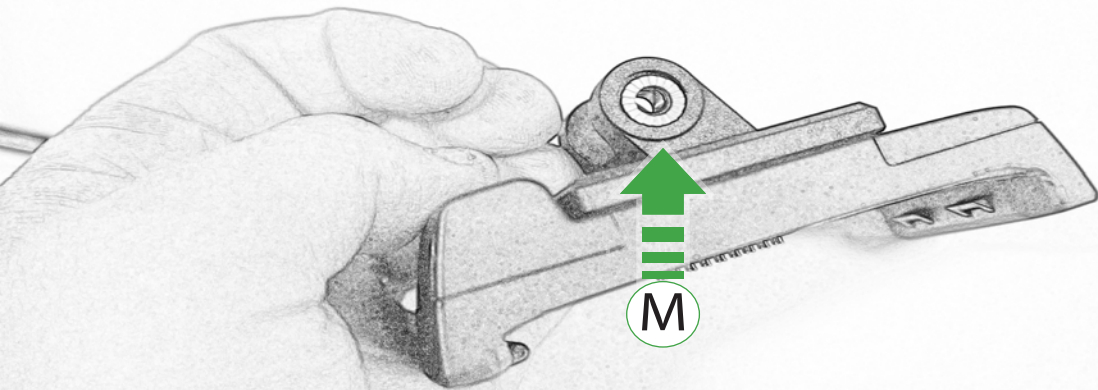

Repeat  
Both Sides

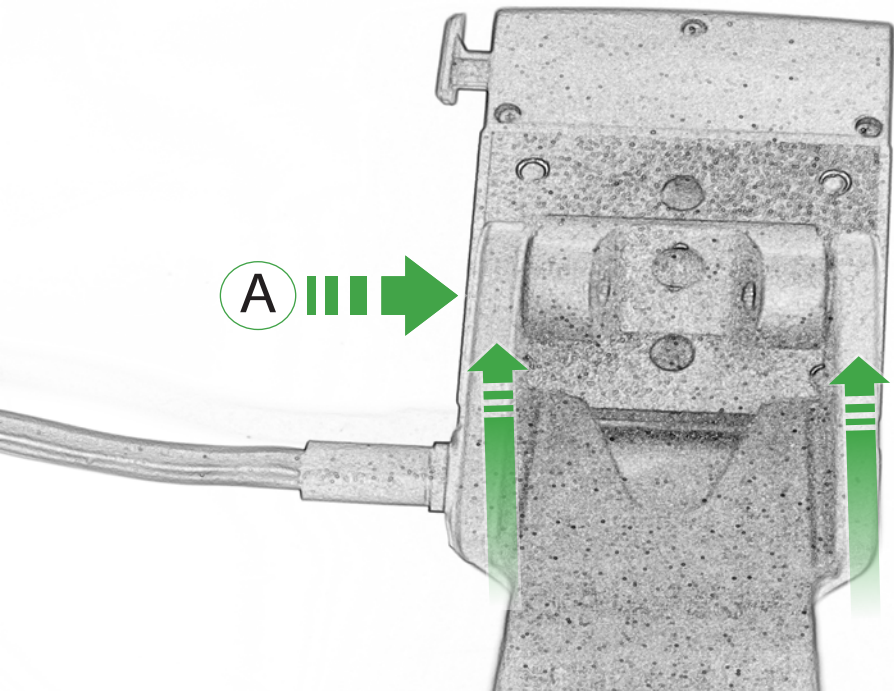



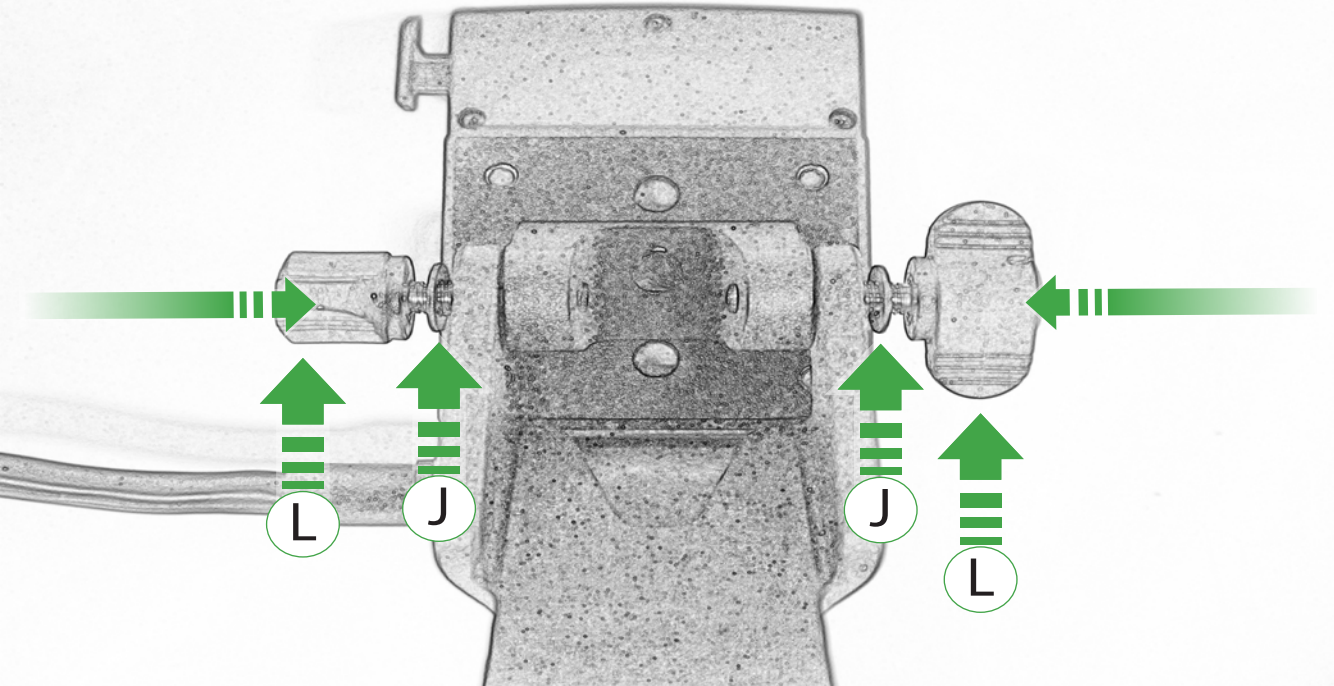

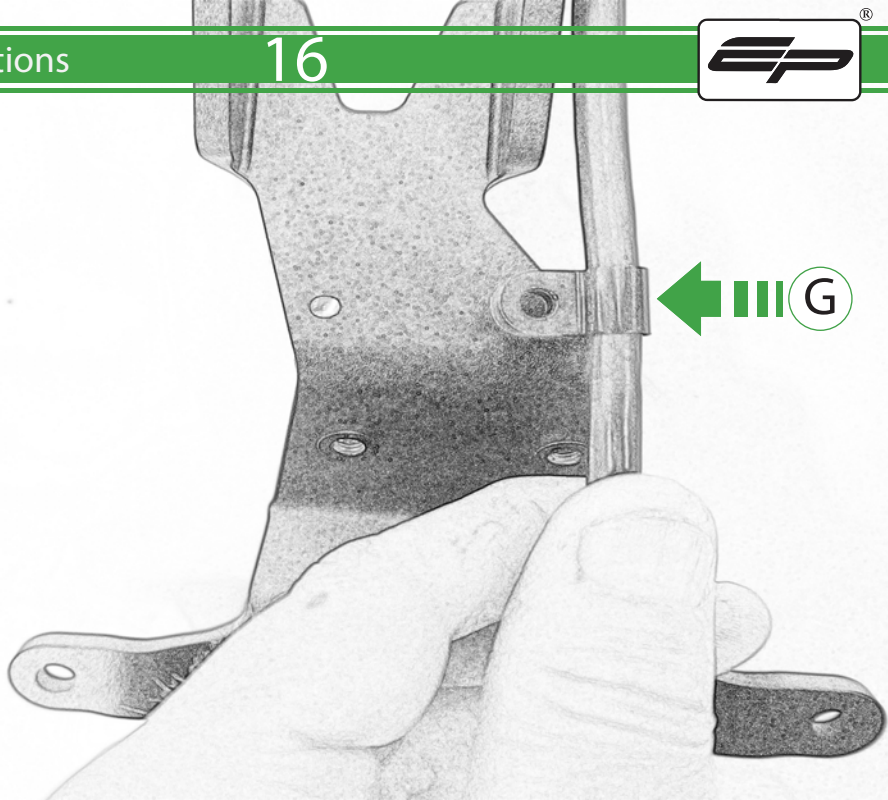

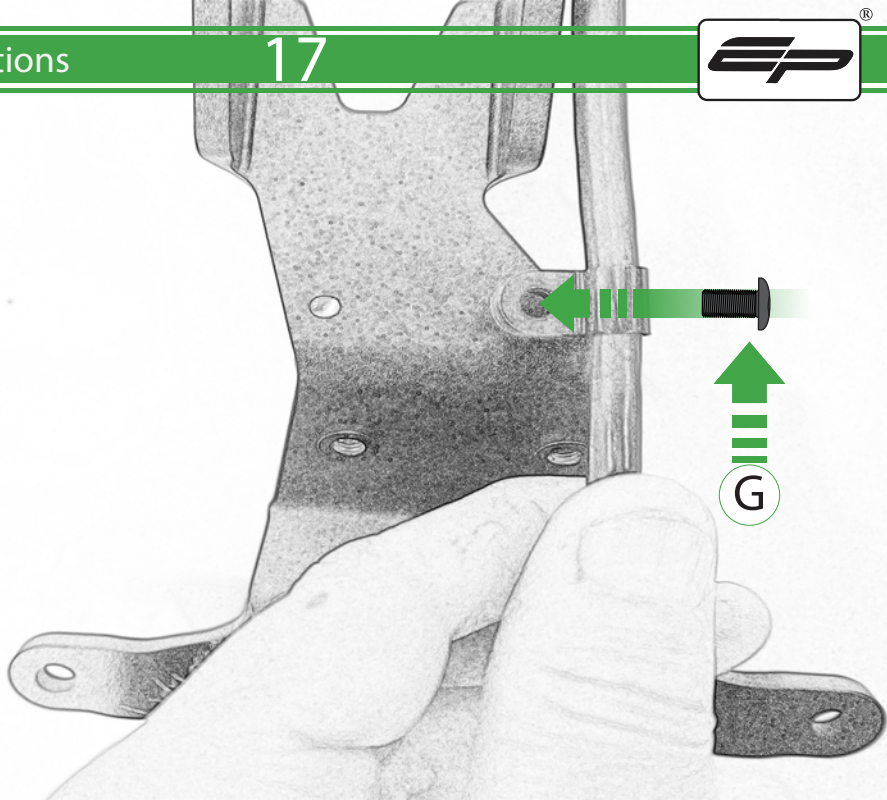

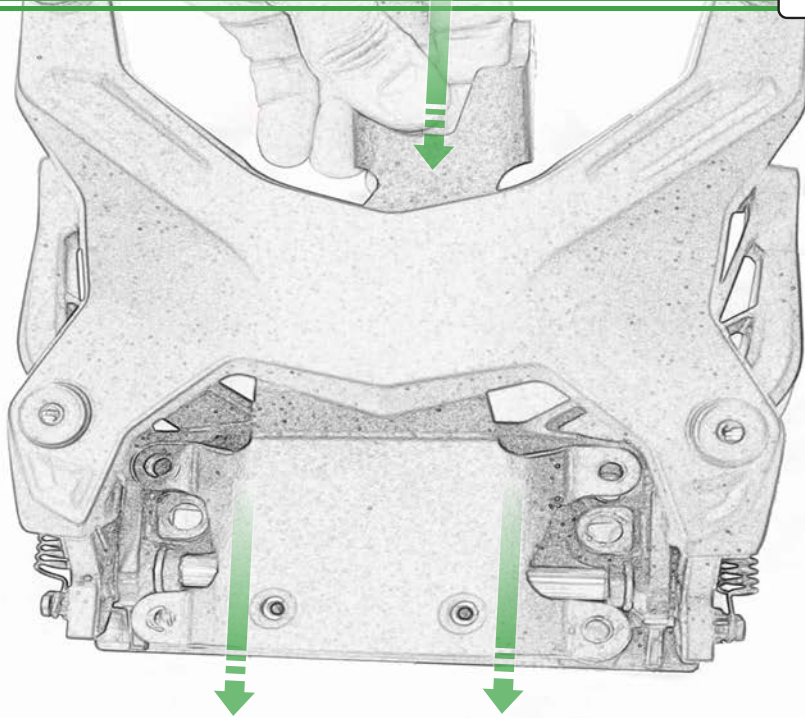

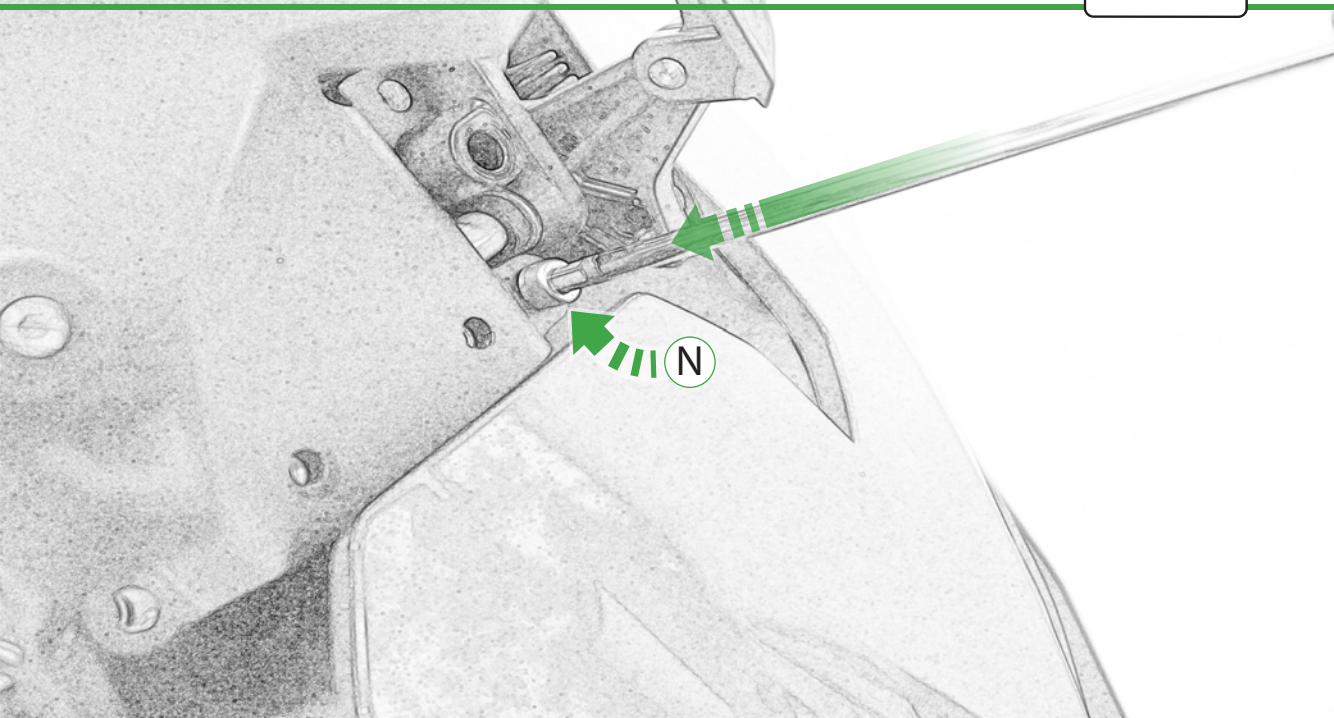

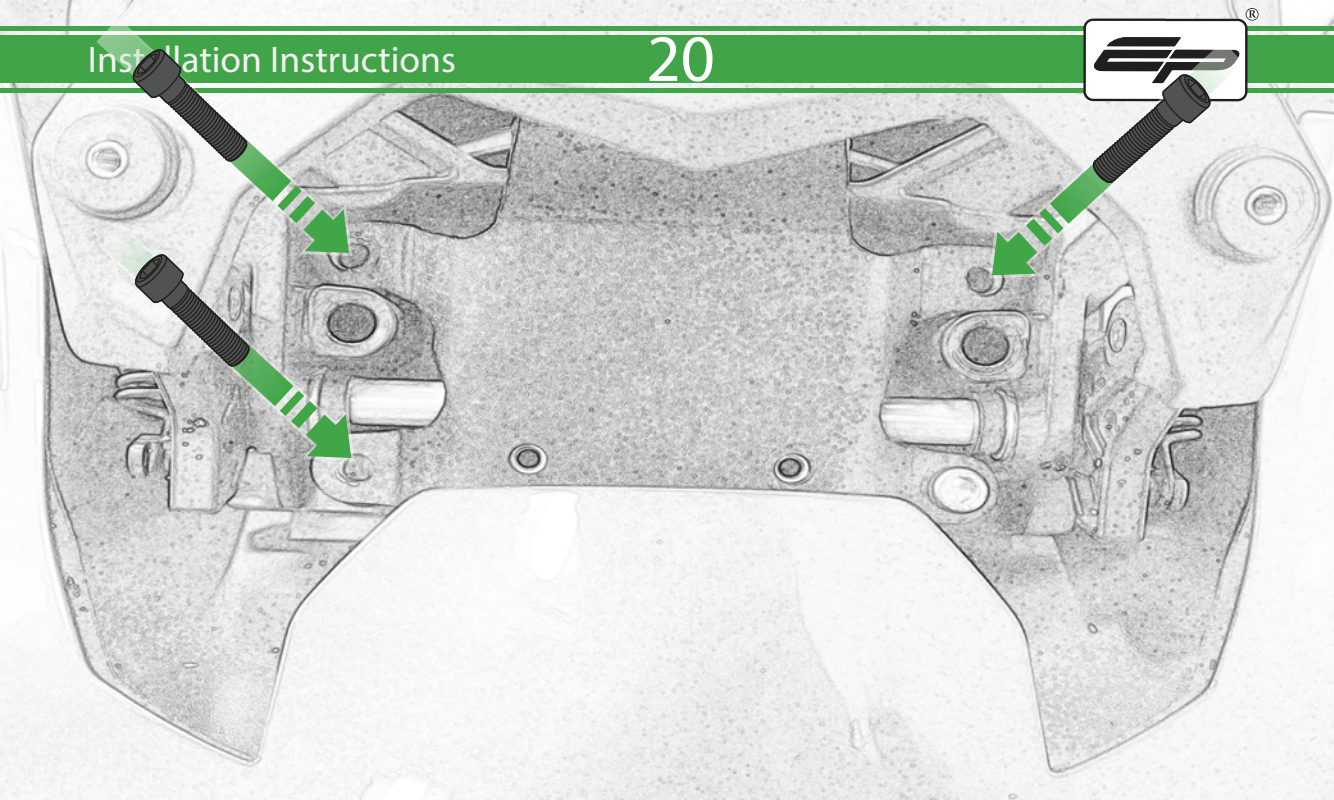

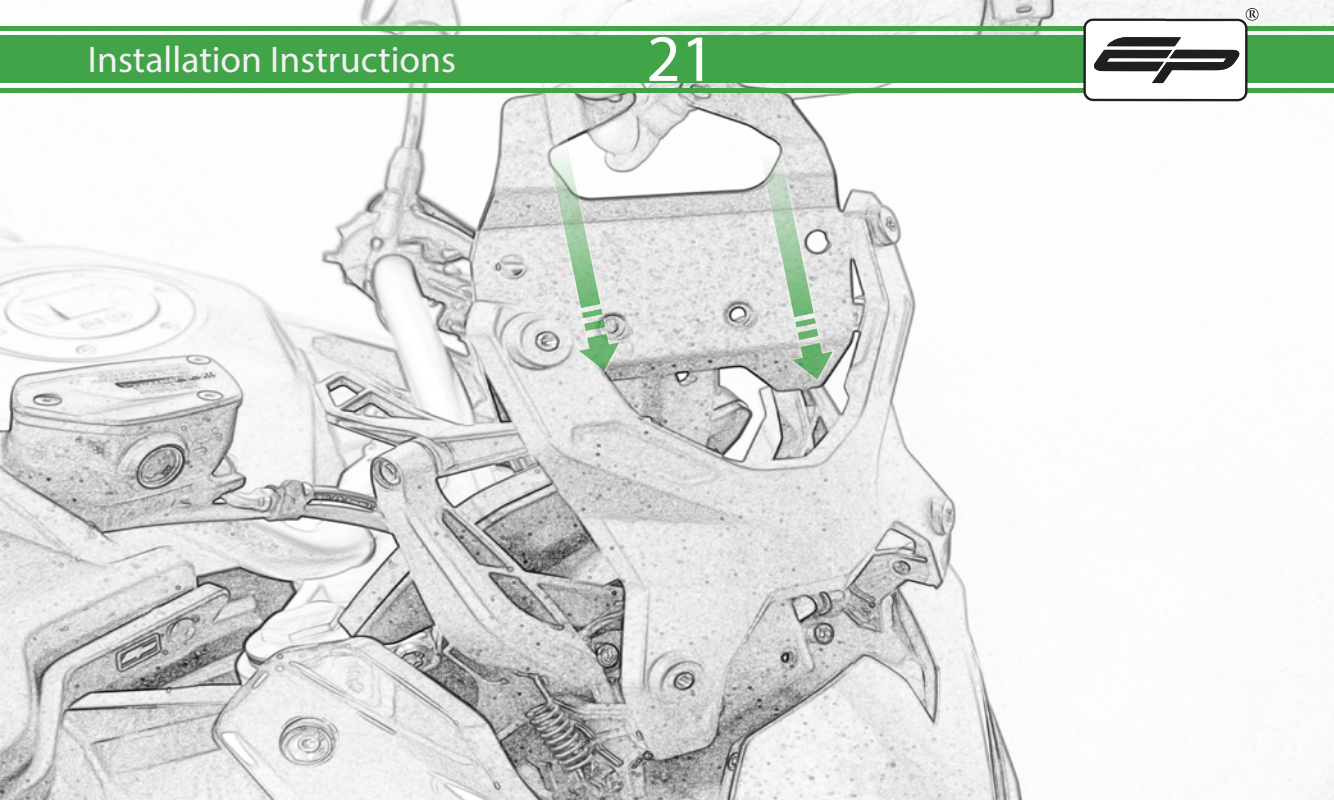

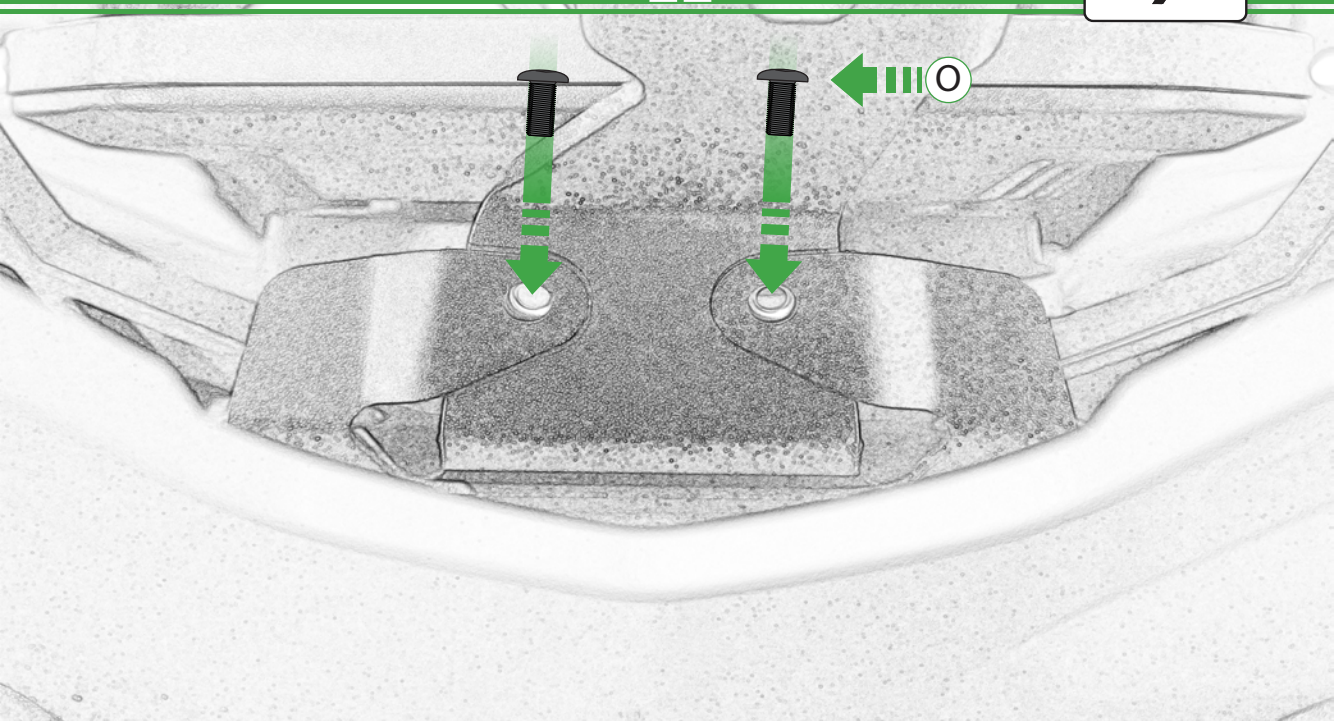





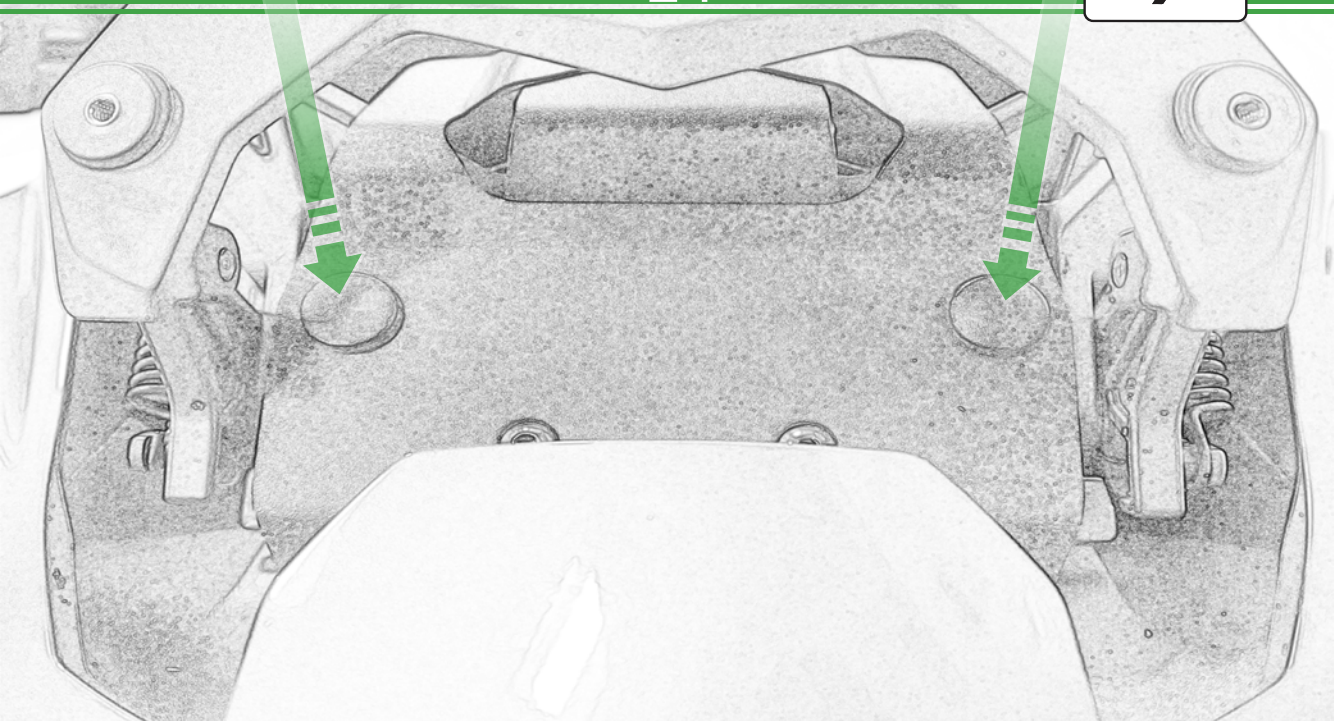

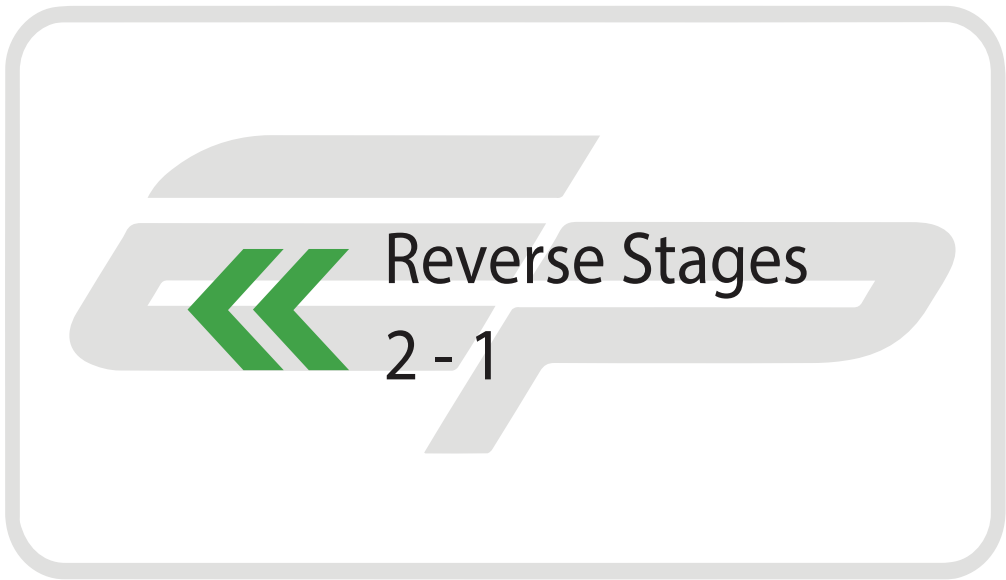



## ESSENTIAL CHECKS

It is recommended that periodic inspections are made to ensure that all bolts are tightened to the specified torque settings.

Should the bike be involved in an accident a thorough inspection should be made and any components that have taken an impact, no matter how small, be replaced



**EVOTECH**®  
P E R F O R M A N C E

[www.evotech-performance.com](http://www.evotech-performance.com)