

ARTAGO®

Special Security Europe



MADE IN VALENCIA
EUROPEAN QUALITY



32

ART

ARTAGO

REGISTERED DESIGN

INNOVATION



VIDEO

TESTED TO THE MAXIMUM LEVEL

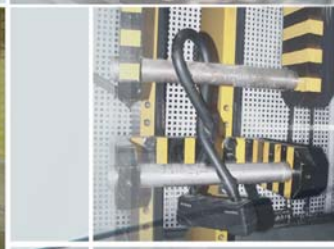
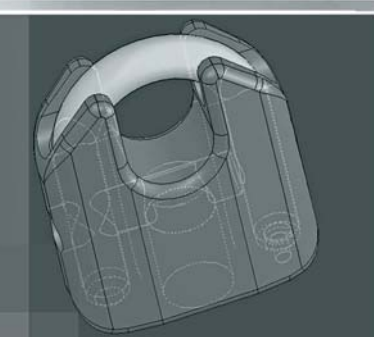
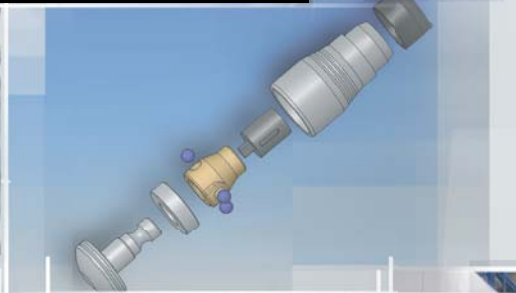

MADE IN VALENCIA
EUROPEAN QUALITY

SECURE
security factory

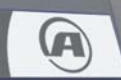

ARTAGO®

Special Security Europe



PROTECTION INSTINCT

SINCE 1976

Tradition and spirit of improvement to create one of the security brands with better reputation worldwide.

Orígenes:

En 1976, en un pequeño taller de pueblo cercano a Valencia, un joven emprendedor y mecánico de motos, Alberto Artagoitia Fernandez, comienza a fabricar amortiguadores de Vespino. Y buscando una solución de seguridad práctica y funcional para el usuario, se crea el primer antirrobo ARTAGO cuyo cuerpo servía también de tornillo del amortiguador, permitiendo así transportar el antirrobo perfectamente integrado.

Evolución:

La marca ARTAGO toma de su fundador mucho más que parte del apellido, toma su espíritu de superación e ilusión por crear las mejores soluciones de seguridad adaptadas a las necesidades reales del motorista.

En los '90, con la incorporación a la fábrica de la segunda generación, comienza la expansión internacional.

En el 2000 se crean los primeros antirrobo homologados SRA y desde el 2003 la fábrica es auditada por la AFNOR para certificar las máximas garantías de calidad en la fabricación de antirrobo homologados NF-FFMC, el más exigente sello de calidad.

En el 2005, el impulso definitivo, viene con la construcción de la nueva y más avanzada fábrica de antirrobo a nivel mundial, que cuenta con un potente laboratorio de pruebas capaz de realizar los tests más destructivos para lograr que los antirrobo ARTAGO "bunker selection" sean lo máximo en seguridad.

Nos origines:

En 1976, dans un petit atelier d'un village proche à Valence, un jeune entrepreneur et mécanicien de motos, Alberto Fernandez Artagoitia, commence à fabriquer des amortisseurs de mobylette Vespino. A la recherche d'une solution de sécurité pratique et fonctionnelle pour l'usager, il crée le premier antivols ARTAGO dont le corps servait aussi de vis de l'amortisseur, permettant ainsi le transport de l'antivol parfaitement intégré.

L'évolution:

Depuis sa création, la marque ARTAGO acquiert de son fondateur une partie de son nom mais aussi son esprit d'excellence et son enthousiasme pour créer les meilleures solutions de sécurité adaptées aux besoins réels du motard.

Dans les années 90, avec l'incorporation de la deuxième génération, l'usine commence son expansion internationale.

En 2000 se créent les premiers antivols homologués SRA, et depuis 2003 l'usine est auditée par l'AFNOR pour certifier le maximum de garantie de qualité dans la production d'antivols homologués NF-FFMC, le sceau le plus exigeant de qualité.

En 2005, elle se consolide grâce à la construction d'une nouvelle usine d'antivols ayant une des technologies les plus avancées au niveau mondial, avec un laboratoire performant où se réalisent les tests les plus destructifs pour que les antivols ARTAGO "bunker selection" représentent le maximum en sécurité.

Origins:

In 1976, in a small town workshop near Valencia, a young entrepreneur and motorcycle mechanic, Alberto Artagoitia Fernandez, begins to manufacture shock absorbers for vespino and seeking a practical and functional security solutions for the user, he created the first ARTAGO lock whose body also served as the shock absorber screw, thus allowing transport the lock perfectly integrated.

Evolution:

The ARTAGO brand takes from its founder more than part of his last name, takes its spirit of improvement and enthusiasm to create the best security solutions tailored to the real needs of the motorcycle rider.

In the '90s, with the incorporation into the factory of the second generation begins the international expansion.

In 2000 the first SRA approved anti-thefts are created and since 2003 the factory is audited by AFNOR to certify the highest level of quality in manufacturing the NF-FFMC approved locks, the most demanding quality seal.

In 2005, the final push comes when building the new and more advanced lock factory worldwide, with a powerful testing lab capable of performing the most destructive tests to ensure that the ARTAGO "bunker selection" locks are the ultimate in security.



“BRAVO À ARTAGO POUR LA QUALITÉ DES ACIERS”

Los mejores resultados en los test comparativos.

ARTAGO es una de las marcas de seguridad con mejor reputación, seleccionada por prestigiosos fabricantes de motos y presente en los 5 continentes.

Les meilleurs résultats dans les tests comparatifs.

ARTAGO est l'une des marques de sécurité les plus réputées, choisie par de prestigieux fabricants de motos et présente sur les 5 continents.

The best results in the comparative tests.

ARTAGO is one of the security brands with better reputation, selected by prestigious motorcycle manufacturers and present on the 5 continents.

TESTED and CERTIFIED

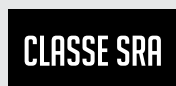

ARTAGO®

Special Security Europe

Disc-tech ART+



La cerradura anti-ganzúa más avanzada y segura con disco anti-taladro de 5 mm.

La serrure anti-crochetage la plus sûre et sophistiquée avec l'exclusif disque anti-perçage de 5mm.

The most advanced and secure anti-picking locking with the unique 5mm anti-drilling disc.



- ES** Con su código puede solicitar un duplicado de la llave y nuevas cerraduras con su misma combinación cuando los necesite.
- FR** Avec votre code vous pouvez commander un double de clé et de nouveaux antivolos avec votre même combinaison quand vous en avez besoin.
- EN** By your code you can order key copies and your new locks with your same key combination when needed.

SERVICE Same Combination EXCLUSIVE

Refer.	2021 P.R.P. NO TAX
SMC	55,00€

- ES** Para la gama alta con cerradura Disc-Tech ART+, puede solicitar un servicio de **producción especial con la misma combinación** de cerradura para **utilizar sus antirrobo** presentes o futuros **con la misma llave** (total 3 llaves por combinación).
- FR** Pour le haut de gamme avec la serrure Disc-Tech ART+, vous pouvez commander le service de **production speciale avec même combinaison** de serrure pour **utiliser vos antivolos** présents et futures **avec la même clé** (totale 3 clés par combinaison)
- EN** For your high-end locks with Disc-Tech ART+ cylinder, you can order the "same key combination" special production service to **enjoy using your present or future locks with the same key** (3 keys total per combination)

COPY SERVICE

Refer.	2021 P.R.P. NO TAX
LLAVE D	16€



BUNKER® Selection



ref. 18XL



ref. 18ART



ref. 120H



ref. 69T/B



ref. 69X



ref. 32



ref. 30X14



ref. 18DUO



ref. 69DUO



ref. 68



ref. 61



VIDEO
ARTAGO TESTING LAB
Bunker selection

ES Con la gama "BUNKER SELECTION" la marca ARTAGO ofrece **los mejores antirrobo n°1 en los test comparativos.**

Selección de los antirrobo de alta gama más exclusivos donde se ha cuidado hasta el último detalle.

CALIDAD EN TODOS LOS SENTIDOS: Integración, funcionalidad y resistencia.

FR Avec la gamme "BUNKER SELECTION" la marque ARTAGO offre **les meilleurs antivolos n° 1 dans les essais comparatifs.**

Sélection d'antivolos haut de gamme les plus exclusifs où chaque détail est soigneusement étudié.

QUALITÉ DANS TOUS LES SENS: Intégration, Fonctionnalité et Résistance.

EN With "BUNKER SELECTION" the ARTAGO brand offers **the best locks No.1 in the comparative tests.**

Selection of the most exclusive high-end security locks where every detail has been taken care.

QUALITY IN EVERY SENSE: Integration, functionality and resistance.



Monoblok system



FORGED steel

- ES** Los mejores resultados en los tests comparativos. Certificado por los más exigentes laboratorios.
- FR** Les meilleurs résultats aux tests comparatifs. Certifié par les laboratoires les plus exigeants.
- EN** The best results in comparative tests. Certified by the most demanding labs worldwide.

BUNKER[®]

Selection



VIDEO

TESTED TO THE MAXIMUM LEVEL



ARTAGO[®]

Special Security Europe

ES Ficha técnica

- Para una composición específica ARTAGO MAXIMO NIVEL.
- Bandeja para mini-catálogos.
- Sistema rotativo de 360°.
- Cierre de seguridad.
- Alta visibilidad y especial para exposición.

FR Fiche technique

- Pour une composition spécifique ARTAGO HAUT DE GAMME.
- Présentoir avec porte mini-catalogue.
- Système de rotation 360°.
- Fermeture de sécurité.
- Haute visibilité et spécial exposition.

EN Technical features

- For a specific composition ARTAGO MAXIMUM LEVEL.
- Display with mini-catalog tray.
- 360° rotating system.
- Security locking.
- High visibility and Special for showrooms.



Refer.	2021
	P.R.P.
	NO TAX
4EM	517,50€

2EM



Refer.	2021
	P.R.P.
	NO TAX
2EM	304,50€

ES Ficha técnica

- Ideal para espacios reducidos.
- Múltiples composiciones gracias a sus ganchos intercambiables.

FR Fiche technique

- Idéal pour espaces réduits.
- Nombreuses possibilités de montage grâce à ses crochets interchangeables.

EN Technical features

- Perfect for reduce places.
- Multiple compositions thanks to the exchangeable hooks.



5EM



Refer.	2021
	P.R.P.
	NO TAX
5EM	182,50€



- ES** Especial mostrador.
- FR** Spécial comptoir.
- EN** Special for the counter.

ES Ficha técnica

- Expositor DEMO de acero de alta calidad.
- Incluye folletos con las ventajas del ARTAGO 32 Sensor.

FR Fiche technique

- Présentoir DEMO acier haute qualité.
- Inclus brochure avec description et avantages de l'ARTAGO 32 Sensor.

EN Technical features

- High quality steel DEMO display.
- Includes brochures with the advantages of the ARTAGO 32 sensor.

Para/pour/for/per
32 - 32X

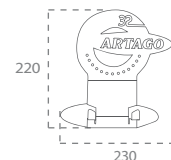

Refer.	2021
	P.R.P.
	NO TAX
32EM	71€

32EM

UNIVERSAL U BRACKETS



Max. Ø18 Tube clamp from Ø18 to Ø25



Refer. 2021 P.R.P. NO TAX
K502 29,99€ 4u.

Solo para el 18ART120
Seulement pour 18ART120
Only for 18ART120

Para tornillos y tubos.
Pour visses et tubes.
For screws and tubes.



FOR ALL MODELS EXCEPT FOR:
18XL / 18ART320 / 120H340-I / RT320 Max. Ø18



Refer. 2021 P.R.P. NO TAX
530.2/B 24,50€ 4u.

Para reposapiés.
Pour le support du repose-pieds.
To footrest.



FOR ALL MODELS EXCEPT FOR:
18XL / 18ART320 / 120H340-I / RT320 Max. Ø18



Refer. 2021 P.R.P. NO TAX
530.4/B 25,25€ 4u.

Para tornillos.
Pour visses.
For screws.

BAJO ASIENTO / SOUS SELLE / UNDER SEAT



HONDA CROSSTOURER + 18ART120



YAMAHA FZ1 + 18XL



SUZUKI GSX-R + 18ART270



SUZUKI GLADIUS 650 + 120K230



BMW F800S + 18ART120

Transport Solutions
Complete list in www.artago.com

TRIUMPH, BMW, DUCATI, HONDA, KAWASAKI, YAMAHA, SUZUKI...



Ø18 XL
SIZE



M.R.T patent locking

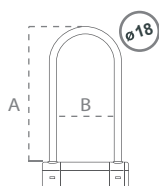

Refer.	A.	B.	2021 P.R.P. NO TAX	Image of box
18XL	310	115	167€	3u.

Disc-tech ART+



Transport Solutions
Complete list
www.artago.com



ES Ficha técnica

- Tamaño XL más resistente, más seguro.
- U Ø18, el más resistente anti-sierra, cizalla, maza, palanca...
- Nuevo concepto de carcasa de nylon reemplazable.
- Mecanismo patentado de bloqueo MRT, dispositivo anti-giro del arco y blindaje de 10mm.
- Cerradura ART+ anti-ganzúa con disco anti-taladro de 5mm.
- Tapa anti-polvo y anti-humedad.
- TRANS_U: Con soporte o acoplado bajo el asiento.
- Testado por los mejores laboratorios europeos.
- Exclusivo sistema anti-vibración en el interior.
- Disponible el servicio de cerradura con la MISMA COMBINACIÓN ART+ (SMC) para todos tus antirrobo.

FR Fiche technique

- Dimensions XL plus résistant, plus sûr.
- Anse Ø18, plus résistante, anti-sciage, coupe-boulon, masse...
- Nouveau concept de coque en nylon interchangeable.
- Mécanisme de verrouillage MRT breveté, dispositif anti-giratoire de la anse et blindage de 10mm.
- Serrure ART+ anti-crochetage avec disque anti-perçage de 5mm.
- Cache de protection contre la poussière et l'humidité.
- TRANS-U: Se range avec support ou sous la selle.
- Qualité contrôlée par le 1er organisme certificateur de France.
- Système exclusif anti-vibration à l'intérieur.
- Disponible le service MÊME SERRURE ART+ (SMC) pour vos autres antivol.

EN Technical features

- XL size, more resistant and safer.
- U Ø18, the most resistant anti-saw, shears, mace, lever...
- New concept of replaceable body cover.
- Patented MRT locking mechanism, anti-rotation device and 10mm armor.
- Anti-picking ART+ locking with the unique 5mm anti-drilling disc.
- Cover against dust and moisture.
- TRANS-U solutions under seat or with bracket.
- Quality control by laboratories certifiers.
- Exclusive anti-vibration inner system.
- ART+ SAME KEY COMBINATION (SMC) service available for your next locks.

CLASSE SRA



Disc-tech ART+



ø18

M.R.T patent locking

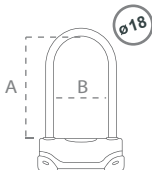

Refer.	A.	B.	2021 P.R.P. NO TAX	Box
18ART320	295	85	155€	4u.
18ART270	245	85	149€	4u.
18ART120	125	85	138€	4u.

Transport Solutions
Complete list
www.artago.com



18ART120



18ART270



ES Ficha técnica

- U ø18, el más resistente anti-sierra, cizalla, maza, palanca...
- Nuevo concepto de carcasa de nylon reemplazable.
- Mecanismo patentado de bloqueo MRT, dispositivo anti-giro del arco y blindaje de 10mm.
- Cerradura ART+ anti-ganzúa con disco anti-taladro de 5mm.
- Tapa anti-polvo y anti-humedad.
- TRANS_U: Con soporte o acoplado bajo el asiento.
- Testado por los mejores laboratorios europeos.
- Exclusivo sistema anti-vibración en el interior.
- Disponible el servicio de cerradura con la MISMA COMBINACIÓN ART+ (SMC) para todos tus antirrobo.

FR Fiche technique

- Anse ø18, plus résistante, anti-sciage, coupe-boulon, masse...
- Nouveau concept de coque en nylon interchangeable.
- Mécanisme de verrouillage MRT breveté, dispositif anti-giratoire de la anse et blindage de 10mm.
- Serrure ART+ anti-crochetage avec disque anti-perçage de 5mm.
- Cache de protection contre la poussière et l'humidité.
- TRANS-U: Se range avec support ou sous la selle.
- Qualité contrôlée par le 1er organisme certificateur de France.
- Système exclusif anti-vibration à l'intérieur.
- Disponible le service MÊME SERRURE ART+ (SMC) pour vos autres antivol.

EN Technical features

- U ø18, the most resistant anti-saw, shears, mace, lever...
- New concept of replaceable body cover.
- Patented MRT locking mechanism, anti-rotation device and 10mm armor.
- Anti-picking ART+ locking with the unique 5mm anti-drilling disc.
- Cover against dust and moisture.
- TRANS-U solutions under seat or with bracket.
- Quality control by laboratories certifiers.
- Exclusive anti-vibration inner system.
- ART+ SAME KEY COMBINATION (SMC) service available for your next locks.



CLASSE SRA

test



Disc-tech ART+

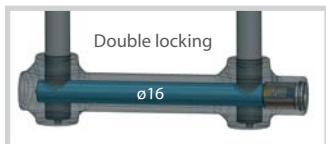

Double locking

ø16

FORGED steel

Monoblok system



REGISTERED DESIGN

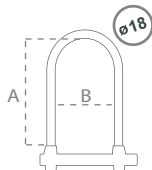

Refer.	A.	B.	2021 P.R.P. NO TAX	
120H340-I	335	120	137€	4u.
120H220-I	210	120	129€	4u.



Transport Solutions
Complete list

www.artago.com



ES Ficha técnica

- Nuevo concepto MONOBLOK en acero forjado de máxima resistencia.
- Mecanismo de doble bloqueo con eje anti-rotación ø16mm.
- U ø18, el más resistente anti-sierra, cizalla, maza, palanca...
- TRANS_U: Con soporte o bajo el asiento (especial Honda).
- Ancho ideal para la rueda de las maxi-scooters.
- Cerradura ART+ anti-ganzúa con disco anti-taladro de 5mm.
- Testado por los mejores laboratorios europeos.
- Doble tratamiento contra la corrosión, interior y exterior.
- Disponible el servicio de cerradura con la MISMA COMBINACIÓN ART+ (SMC) para todos tus antirrobo.

FR Fiche technique

- Avantage du système MONOBLOK en acier forgé plus résistant.
- Mécanisme de double verrouillage anti-giratoire avec axe ø16mm.
- Anse ø18, plus résistante, anti-sciage, coupe-boulon, masse...
- TRANS_U: Sous la selle (spécial Honda) ou avec support.
- Largeur idéale pour les roues des maxi-scooters.
- Serrure ART+ anti-crochetage avec disque anti-perçage de 5mm.
- Qualité contrôlée par le 1er organisme certificateur de France.
- Double traitement contre la rouille intérieure et extérieure.
- Disponible le service MÊME SERRURE ART+ (SMC) pour vos autres antivol.

EN Technical features

- New MONOBLOK body concept, made in high-tech forged steel, more resistant.
- Double locking mechanism with anti-rotation ø16mm bar.
- ø18 U, the most resistant anti-saw, shears, mace, lever...
- TRANS_U solutions under seat (special Honda) or with bracket.
- Perfect size for the scooter wheels.
- Anti-picking locking ART+ with 5mm anti-drilling disc.
- Quality control by laboratories certifiers.
- Double anti-rust treatment, inside-outside.
- ART+ SAME KEY COMBINATION (SMC) service available for your next locks.

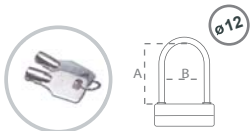

Refer.	A.	B.	2021 P.R.P. NO TAX	4u.
547	150	68	43,25€	4u.

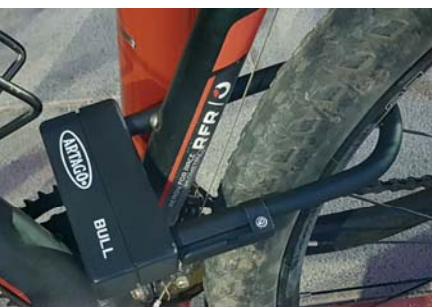

BRACKET INCLUDED



ES Ficha técnica

- U compacta y ligera ideal para bicicleta y scooter.
- Tamaño óptimo de fácil de transportar.
- Soporte para tubos incluido.
- Mecanismo de doble bloqueo.
- Horquilla de acero Ø12.
- Cerradura de seguridad con bola de acero anti-taladro.

FR Fiche technique

- U compact et léger idéal pour vélo et scooter.
- Taille optimale facile à transporter.
- Support pour tubes inclus.
- Mécanisme de double verrouillage.
- Anse en acier Ø12.
- Serrure de sécurité avec bille en acier anti-perçage.

EN Technical features

- Light and Compact U lock, ideal for bicycle and scooter.
- Optimum size easy to transport.
- Tube bracket holder included.
- Double locking mechanism.
- Ø12 U steel schackle.
- Security locking with anti-drilling steel ball.

32 UNIVERSAL BRACKETS



For bars of maximum 25mm

BMW K1200R SPORT '07-09



Refer. 2021 P.R.P. NO TAX 
K200 29€ 4u.

Para reposapiés.
 Au support de repose-pied.
 To footrest.



For tubes from Ø18 to Ø25

BMW R1200GS'14 >>

YAMAHA DRAGSTAR



Refer. 2021 P.R.P. NO TAX 
K202 30€ 4u.

Para tubos y tornillos.
 Pour tubes et visse.
 For tubes and screws.



Refer. 2021 P.R.P. NO TAX 
K203 30,50€ 4u.

Tornillos estribera
 Vis repose-pieds
 Screw footrest

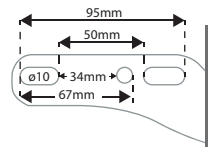

32 INTEGRATION KIT Special application



BMW S1000RR'13>+K220



HONDA CB600F'08>+K206CB



KAWASAKI ER6'12>+K218



DUCATI HYPERMOTARD'09>+K211HYP



KAWASAKI Z800'13>+K219Z



YAMAHA MT-09'14>+K221

Special application & Integration Kit

Complete list in www.artago.com

TRIUMPH, BMW, DUCATI, HONDA, KAWASAKI, YAMAHA, SUZUKI...



ref. CR2-KIT



Disc-tech ART+



REPLACEABLE module
ref. 30MA-KIT

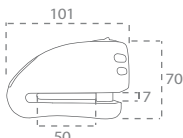

REGISTERED DESIGN

Refer.	Ø	2021 P.R.P. NO TAX	4u.
30X14 14	14	143€	4u.
30X10 10	10	138€	4u.

Transport Solutions
K400/K402/K403



ref. K400



ref. K402



ref. K403



LED SIGNAL

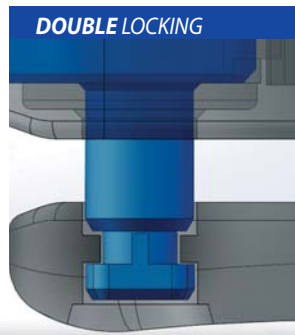

DOUBLE LOCKING

Transport Solutions

ES Ficha técnica

- **CON o SIN ALARMA:** Función X2 ON. El usuario puede elegir si activar el sistema electrónico independiente, o utilizar únicamente el resistente antirrobo mecánico.
- **MODULO INDEPENDIENTE y REEMPLAZABLE.**
- **ALARM+WARNING:** Función alarma + función AVISADOR que diferencia entre un intento de robo y un olvido. Primero se activa el AVISADOR de bips progresivos, reservándose la ALARMA para un intento de robo, aumentando la eficacia y la vida de las baterías.
- **TRIPLE SECURITY FUNCTION:** ANTIRROBO homologado de alta gama / ALARMA / AVISADOR antiolvido.
- Sistema de **DOBLE CIERRE** con eje de acero especial Ø14/Ø10.
- Cerradura **ART+** anti-ganzúa con disco anti-taladro de 5mm.
- El más **RESISTENTE AL AGUA** gracias a su modulo electrónico sellado herméticamente.
- **ERGONOMIC DESIGN:** Diseño compacto y funcional, se adapta a tu mano.
- Disponible el servicio de cerradura con la **MISMA COMBINACIÓN ART+** (SMC) para todos tus antirrobo.

FR Fiche technique

- **AVEC ou SANS ALARME:** Fonction X2 ON. L'utilisateur peut choisir entre activer le système électronique ou l'utiliser comme un antivol mécanique.
- **MODULE ALARME INDEPENDANT et REMPLAÇABLE.**
- **ALARME+WARNING:** Fonction alarme + fonction avertisseur, faisant la différence entre la tentative de vol ou l'oubli. Tout d'abord l'avertisseur de bips progressifs s'active, réservant l'ALARME pour la tentative de vol, en augmentant son efficacité et la durée de vie de ses piles.
- **TRIPLE FONCTION SECURITE:** ANTIVOL homologué haut de gamme / ALARME / AVERTISSEUR anti-oublis.
- Système de **DOUBLE FERMETURE** avec axe en acier spécial Ø14/Ø10.
- Serrure **ART+** anticrochetage avec disque antiperçage de 5mm.
- Le plus **RÉSISTANT À L'EAU** grâce à sa puce électronique totalement étanche.
- **DESIGN ERGONOMIQUE:** Design compact et fonctionnel, s'adapte à votre main.
- Disponible le service **MÊME SERRURE ART+** (SMC) pour vos autres antivols.

EN Technical features

- **WITH or WITHOUT ALARM:** X2 ON function, the user can choose whether to activate the electronic system or use only the resistant mechanical lock.
- **REPLACEABLE & INDEPENDENT ALARM MODULE.**
- **ALARM+WARNING:** The 32 Sensor difference between a theft attack and forgetting the lock on. The WARNING progressive beeps are triggered first, reserving the ALARM for a theft attack, increasing the efficacy and batteries life.
- **TRIPLE SECURITY FUNCTION:** Maximum level homologated LOCK / ALARM / WARNING.
- **DOUBLE LOCKING** system with Ø14/Ø10 special steel shaft.
- Anti-picking **ART+** locking with 5mm anti-drilling disc and dust cover.
- The most **RESISTANT TO THE WATER** thanks to its electronic module hermetically sealed.
- **ERGONOMIC DESIGN:** Compact and functional design, fits your hand.
- **ART+ SAME KEY COMBINATION (SMC)** service available for your next locks.

ARTAGO®

Special Security Europe

Independent Electronic System

ALARM
+WARNING

120db

24S
SENSOR

Click ON

Scooter Special

24S



REGISTERED DESIGN



Ø6

Transport Solutions
K351/K352

ref. K351

Tornillos/visses/screws



ref. K352

Tubos/tubes/tubi



K352

ES Ficha técnica

- Ergonómico, Press & GO uso rápido con una mano.
- Resistente al agua.
- Sistema "DOBLE ALERTA". Además de la señal sonora, posee la señal lumínica más potente del mercado.
- Con o Sin alarma. Función ON-OFF.
- Eje de cierre de acero Ø6, universal scooter.
- Cerradura anti-ganzúa con disco anti-taladro de 2 mm.
- 2+1 llaves reversibles con servicio de duplicado.
- Tapa deslizante anti-polvo.
- Combina con los soportes anti-vibración ref. K351 y ref. K352.

FR Fiche technique

- Ergonomique, Press & GO utilisation rapide d'une main.
- Résistant à l'eau.
- Système de "DOUBLE ALARME". En plus du signal sonore, le signal lumineux le plus puissant du marché.
- Avec o Sans Alarme. Fonction ON/OFF.
- Axe de fermeture en acier Ø6, universel scooter.
- Serrure anti-crochetage avec disque anti-perçage de 2 mm.
- 2+1 clés plates réversibles avec service de duplicata par code.
- Cache de protection contre la poussière.
- Combinaison avec les supports anti-vibration ref. K351 et ref. K352.

EN Technical features

- Ergonomic, Press & GO quick use with one hand.
- Water resistant.
- "DOUBLE ALARM" system. In addition to the beeps, the most powerful light signal in the market.
- With or Without alarm. ON-OFF function.
- Steel shaft Ø6, scooter universal.
- Anti-picking locking with a 2mm anti-drilling disc.
- 2+1 reversible keys with code copy service.
- With cover against the dust.
- Combines with the anti-vibration brackets ref. K351 and K352.

ON/OFF WITH or WITHOUT AVEC ou SANS CON o SIN ALARM

WATER PROOF

POWERFUL LIGHT SIGNAL

PATENTED ALARM SYSTEM

LITHIUM CR2 BATTERY
ref. CR2-KIT

Press & GO



PROTECTION COVER

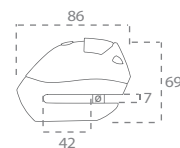

REPLACEABLE module
ref. 24MA-KIT

Refer.	Ø	2021 P.R.P. NO TAX	
24S.6M	6	66,50€	4u.

Press & Go



Protection cover



Powerful LIGHT signal



MADE IN VALENCIA
EUROPEAN QUALITY

+ info
www.artago.com

CLASSE SRA



Nº1
TEST



Monoblok
system

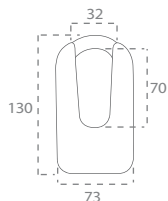

69T/B

Ø15



Ø14



69X

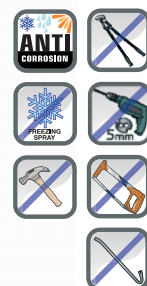

Disc-tech ART+



REGISTERED DESIGN

Refer.	Ø	2021 P.R.P. NO TAX	u.
69T/B	15	105€	4u.
69X	14	102€	4u.

Transport Solutions
568/B / 568.2 / K103

Transport solution K103



ES Ficha técnica

- Nuevo concepto MONOBLOK en acero forjado de máxima resistencia.
- **Los mejores resultados en los tests comparativos.**
- Las dimensiones más universales y versátiles.
- Combina con el 1º soporte anti-vibración ref. 568/B y 568.2 y K103.
- **Integración total con los KITS DE INTEGRACIÓN.**
- Cerradura ART+ anti-ganzúa con disco anti-taladro de 5mm.
- Tapa anti-polvo y anti-humedad.
- Doble tratamiento contra la corrosión, interior y exterior.
- Disponible el servicio de cerradura con la MISMA COMBINACIÓN ART+ (SMC) para todos tus antirrobo.

FR Fiche technique

- Avantage du système MONOBLOK en acier forgé.
- **Le meilleur résultat du test comparatif.**
- Dimensions les plus universelles.
- Combinaison avec le 1er support anti-vibration ref. 568/B, 568.2 et K103.
- **Intégration totale avec les KITS D'INTEGRATION.**
- Serrure ART+ anticrochetage avec disque antiperçage de 5mm.
- Cache de protection contre la poussière et l'humidité.
- Double traitement contre la rouille à l'intérieur et à l'extérieur.
- Disponible le service MÊME SERRURE ART+ (SMC) pour vos autres antivol.

EN Technical features

- New MONOBLOK body concept in forged steel, the most resistant.
- **The best results in the comparative tests.**
- Design and dimensions more universal.
- Combines with the 1st anti-vibration bracket ref. 568/B, 568.2 and K103
- **Total integration with the INTEGRATION KITS.**
- Anti-picking ART+ locking with 5mm anti-drilling disc.
- Cover against dust and moisture.
- Double anti-rust treatment, inside-outside.
- ART+ SAME KEY COMBINATION (SMC) service available for your next locks.



69/69X UNIVERSAL BRACKETS



For bars of maximum 30mm

HONDA CROSSTOURER '12>



Refer.	2021 P.R.P. NO TAX	
568/B	29€	4u.

Para reposapiés.
Au support de repose-pied.
To footrest.



Tube clamp from Ø18 to Ø25

BMW R1200GS'14>

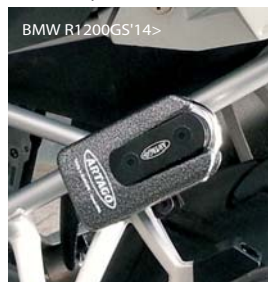

YAMAHA GRAGSTAR



Refer.	2021 P.R.P. NO TAX	
568.2	30€	4u.

Para tubos y tornillos.
Pour tubes et vis.
For tubes and screws.



YAMAHA MT-07'14>



Refer.	2021 P.R.P. NO TAX	
K103	30,50€	4u.

Tornillos estribera
Vis repose-pieds
Screw footrest

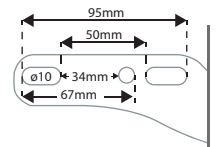

69/69X INTEGRATION KIT Special application



Special application & Integration Kit

Complete list in www.artago.com

TRIUMPH, BMW, DUCATI, HONDA, KAWASAKI, YAMAHA, SUZUKI...

sopORTE incluido
support inclus
bracket included

Cierre de 4 bolas
Fermeture 4 billes
4 balls locking

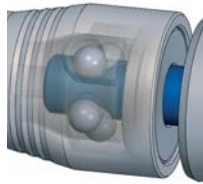

REGALO
CADEAU
GIFT

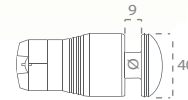

562



Refer.	Ø	2021 P.R.P. NO TAX	
562-I	14	85,00€	4u.



Transport Solution

ES Ficha técnica

- Cierre de 4 bolas de acero, con apertura frontal.
- Cuerpo y eje Ø14, de acero endurecido anti-sierra, cizalla...
- Cerradura anti-ganzúa con disco anti-taladro de 2,5mm.
- Tapa anti-polvo y anti-humedad.
- 2+1 llaves reversibles y servicio de duplicados por código.
- De regalo, cable "reminder" y soporte de transporte.

FR Fiche technique

- Fermeture, 4 billes en fer, avec ouverture frontale.
- Corps et axe Ø14 en acier durci anti-sciage, cisaille...
- Serrure anti-crochetage avec disque anti-perçage de 2.5mm.
- Cache de protection contre la poussière.
- 2+1 clés plates réversibles avec service de duplicata par code.
- Câble de rappel et support de transport en cadeau.

EN Technical features

- 4 balls locking with front opening, and dust cover.
- Body and Ø14 axle made of special hardened steel.
- Anti-picking locking with a 2.5mm anti-drilling disc.
- With cover against dust and moisture.
- 2+1 reversible keys with code copy service.
- Supplied with both, reminder cable and bracket.

Moto 66.11T/B Ø11



Custom, Maxiscooter 66.7T/B Ø7



Transport 569/P



Monoblok



Refer.
569/P



Refer.
K602



Custom / Maxi Scooter

66

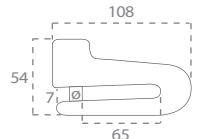

Refer.	Ø	2021 P.R.P. NO TAX	
66.7T/B	7	69,00€	6u.



R1

UNIVERSAL
ACCESSORY
REMINDER
FOR DISC LOCKS

Refer.	2021 P.R.P. NO TAX	
R1	4,65€	12u.



Disc-tech ART+



Refer.	U-bolt	Chain	2021 P.R.P. NO TAX	Box
XLC100	18XL	14.100	242,00€	1u.
320C100	18ART320	14.100	232,00€	1u.
270C100	18ART270	14.100	224,00€	1u.
120C100	18ART120	14.100	215,00€	1u.



ES Ficha técnica

- Combinación de U ø18 + cadena ø15 (100cm).
- Cadena ø15 especial anti-sierra, cizalla, maza, palanca...
- U ø18, el más resistente anti-sierra, cizalla, maza, palanca...

FR Fiche technique

- Combinaison du U ø18 + chaîne ø15 (100cm).
- Chaîne ø15 traitée anti-sciage, coupe-boulon, masse...
- Anse ø18, la plus résistante, anti-sciage, coupe-boulon, masse...

EN Technical features

- ø18 U + ø15 chain (100cm) combination.
- ø15 chain, anti saw, shears, mace, lever...
- U ø18, the most resistant anti saw, shears, mace, lever...

PARKING SPECIAL

XXXcm
a medida/sur mesure/on demand.



Refer.	L.	2021 P.R.P. NO TAX	Box
14.XXX	XXX	81€/Meter	2u.
14.150	150	122,00€	2u.
14.120	120	97,64€	2u.
14.100	100	81,00€	2u.



14



ES Ficha técnica

- Cadena ø15 especial anti sierra, cizalla, maza, palanca...
- Combina con todos los antirrobo del mercado.
- Para columnas de parking fabricación XXX cm a medida.

FR Fiche technique

- Chaîne ø15 traitée anti-sciage, coupe-boulon, masse...
- Combine avec tous les antivols du marché.
- Pour les piliers de parking, XXX cm, sur mesure.

EN Technical features

- ø15 chain, anti saw, shears, mace, lever...
- Combines with all the locks of the market.
- For parking pillars, made XXX cm on demand.

CLASSE SRA

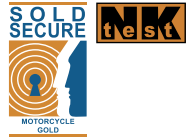

Nº1
TEST



Monoblok
system

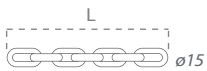

Refer.	L.	2021 P.R.P. NO TAX	u.
69T150	150	227,00€	2u.
69T120	120	202,64€	2u.
69T100	100	186,00€	2u.

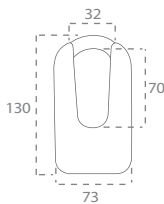

Disc-tech ART+



duo



ES Ficha técnica

- Doble función, el candado también sirve como antirrobo de disco.
- Nuevo concepto de cuerpo MONOBLOK, lo más resistente.
- Cerradura ART+ anti-ganzúa con disco anti-taladro de 5mm.
- Tapa anti-polvo y anti-humedad.
- Cadena ø15 especial anti-sierra, cizalla, maza, palanca...
- Doble tratamiento contra la corrosión, interior i exterior.
- Disponible el servicio de cerradura con la MISMA COMBINACIÓN ART+ (SMC) para todos tus antirrobo.

FR Fiche technique

- Double fonction, le cadenas peut être utilisé comme un bloque-disque.
- Nouveau concept de corps monoblok plus résistant.
- Serrure ART+ anti-crochetage avec le disque anti-perçage de 5mm.
- Cache de protection contre la poussière et l'humidité.
- Chaîne ø15 traitée anti-sciage, coupe-boulon, masse...
- Double traitement contre la rouille à l'intérieur et à l'extérieur.
- Disponible le service MÊME SERRURE ART+ (SMC) pour vos autres antivol.

EN Technical features

- Double function, the lock can be used as a disc lock.
- New concept of Monoblok body, more resistant.
- Anti-picking ART+ locking with the unique 5mm anti-drilling disc.
- Dust cover.
- ø15 chain, anti saw, shears, mace, lever...
- Double anti-rust treatment, inside-outside.
- ART+ SAME KEY COMBINATION (SMC) service available for your next locks.



Nº1
TEST



Monoblok
system



Refer.	L.	2021 P.R.P. NO TAX	
68T150	150	211,60€	2u.
68T120	120	187,24€	2u.
68T100	100	170,60€	2u.
68T/B		89,60€	4u.

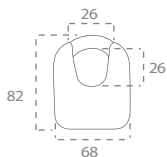

Ref. 68T/B

Disc-tech ART+



x3
copy service
B 0294



ES Ficha técnica

- Nuevo concepto de cuerpo MONOBLOK, lo más resistente.
- Cerradura ART+ anti-ganzua con disco anti-taladro de 5mm.
- Tapa anti-polvo y anti-humedad.
- Cadena ø15 especial anti-sierra, cizalla, maza, palanca...
- Doble tratamiento contra la corrosión, interior i exterior.
- Disponible el servicio de cerradura con la MISMA COMBINACIÓN ART+ (SMC) para todos tus antirrobos.

FR Fiche technique

- Nouveau concept de corps MONOBLOK plus résistant.
- Serrure ART+ anti-crochetage avec disque anti-perçage de 5mm.
- Cache de protection contre la poussière et l'humidité.
- Chaîne ø15 traitée anti-sciage, coupe-boulon, masse...
- Double traitement contre la rouille à l'intérieur et à l'extérieur.
- Disponible le service MÈME SERRURE ART+ (SMC) pour vos autres antivol.

EN Technical features

- New concept of Monoblok body, more resistant.
- Anti-picking ART+ locking with 5mm anti-drilling disc and dust cover.
- ø15 chain, anti-saw, shears, mace, lever...
- Double anti-rust treatment, inside-outside.
- ART+ SAME KEY COMBINATION (SMC) service available for your next locks.



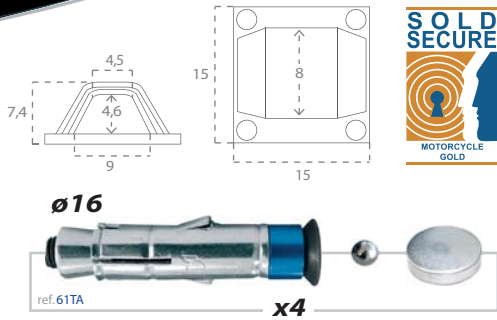

Refer.	mm	2021 P.R.P. NO TAX	4u.
61	6+6	92,00€	4u.

BUNKER® Selection

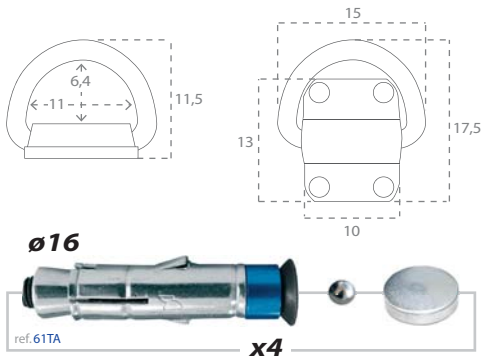

60



Refer.	Ø	2021 P.R.P. NO TAX	4u.
60	20	88,00€	4u.

BUNKER® Selection

Monoblok system

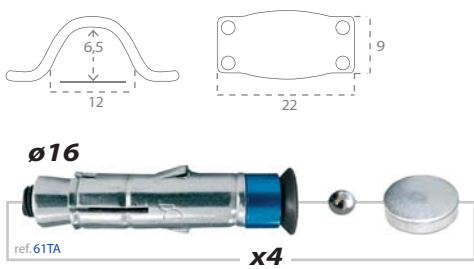

FORGED steel

58



Refer.	mm	2021 P.R.P. NO TAX	4u.
58	12	79,00€	4u.



52

Refer.	Ø	2021 P.R.P. NO TAX	4u.
52	12	38,00€	4u.



BP68M



Ref. 68T/B

BP68S



BUNKER PARK

Refer.		2021 P.R.P. NO TAX	
BP68M	MOTO	659€	1u.
BP68S	SCOOTER	617€	1u.



Ref. 68T/B

BPR68M



BUNKER PARK & ROLL

Refer.		2021 P.R.P. NO TAX	
BPR68M	MOTO	935€	1u.
BPR68S	SCOOTER	893€	1u.

BUNKER Park & Roll - 360° ROTATION



ANCHORED TO THE GROUND



EASY OUT - PATENTED



ES Aparca tu moto en un BUNKER. Sus características exclusivas lo convierten en el antirrobo de parking más seguro y fiable para tu MOTO o SCOOTER.

La versión ROLLing te permite de forma fácil y segura colocar tu moto junto a la pared y aprovechar al máximo tu plaza de parking o garaje.

FR Garez votre moto dans un BUNKER. Rien n'est plus sûr. Ces caractéristiques exclusives en font le système de parking sécurisé le plus fiable.

La version ROLLing vous permet de garer facilement votre véhicule contre le mur, pour optimiser votre espace de stationnement.

EN Park your motorcycle in a BUNKER. Nothing more secure. Its exclusive features make it the most secure and reliable parking lock for your Motorcycle or Scooter.

ROLLing version allows you to park against the wall to maximize your parking space or garage.





Disc-tech ART+



Refer.	L.	2021 P.R.P. NO TAX	3u.
5315	150	89,00€	3u.
5312	120	85,00€	3u.
5310	100	79,00€	3u.



23gr.



ES Ficha técnica

- El articulado más resistente, con tratamiento anti sierra.
- Las dimensiones más universales y versátiles.
- Cerradura ART+ anti-ganzúa con disco anti-taladro de 5mm.
- Tapa anti-polvo y anti-humedad.
- Disponible el servicio de cerradura con la MISMA COMBINACIÓN ART+ (SMC) para todos tus antirrobo.

FR Fiche technique

- Le système le plus résistant, avec traitement anti-siage.
- Dimensions les plus universelles.
- Serrure ART+ anticrochetage avec disque antiperçage de 5mm.
- Cache de protection contre la poussière et l'humidité.
- Disponible le service MÈME SERRURE ART+ (SMC) pour vos autres antivols.

EN Technical features

- The most resistant joint lock.
- Design and dimensions more universal.
- Anti-picking ART+ locking with 5mm anti-drilling disc.
- Cover against dust and moisture.
- ART+ SAME KEY COMBINATION (SMC) service available for your next locks.

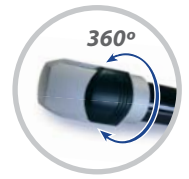

Refer.	L.	2018 P.R.P. NO TAX	
5150	150	62€	4u.
5120	120	56€	5u.
5100	100	53€	7u.



ES Ficha técnica

- Cuerpo giratorio con tapa anti-polvo.
- Cerradura de seguridad con llave de puntos reversible.

FR Fiche technique

- Corps de fermeture giratoire avec cache de protection.
- Serrure de sécurité avec clé plate à points, réversible.

EN Technical features

- Revolving body-lock with sliding dust cover.
- Security locking with reversible flat key.



62



Refer.	L.	2020 P.R.P. NO TAX	
622P	100	39,99€	7u.

EXCLUSIVE ARTAGO INNOVATION
PATENTED

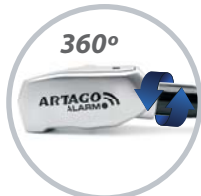

Refer.

...ALM

Según el MODELO Y AÑO de tu scooter
Selon le modèle et l'année de votre scooter
Depending on the model and year of your scooter
Complete list in www.artago.com

LOCKED



SVM SYMPHONY 125 E5 '21 >

TRANSPORT



HONDA VISION 110 '21 >

ES Ficha técnica

- **NUEVO, EXCLUSIVO Y PATENTADO.**
- Potente alarma de scooter **sin instalación.**
- Función **DON'T TOUCH**, alerta incluso del intento de robo.
- Cable de acero, blindado con casquillos y bolas de acero.
- Apertura lateral con disco anti-taladro de 2,5mm.
- Integrado con soporte fijación para cada scooter.
- **Doble función** casco/moto.

FR Fiche technique

- **NOUVEAU, EXCLUSIF ET BREVETÉ.**
- Alarme scooter puissante **sans installation.**
- Fonction **DON'T TOUCH**, même alertes de tentative de vol.
- Câble en acier, blindé avec des douilles et des billes en acier.
- Ouverture latérale avec disque anti-perçage de 2,5 mm.
- Intégré avec support de fixation pour chaque scooter.
- **Doble fonction** casque / moto.

EN Technical features

- **NEW, EXCLUSIVE AND PATENTED.**
- Powerful scooter alarm **without installation.**
- **DON'T TOUCH** function, even alerts of attempted theft.
- Steel cable, armored with steel bushings and balls.
- Side opening with 2.5mm anti-drill disc.
- Integrated with fixing bracket for each scooter.
- **Dual function** helmet / motorcycle.



Disc-tech ART+



Refer.
...ART

Según el MODELO Y AÑO de tu scooter
Selon le modèle et l'année de votre scooter
Depending on the model and year of your scooter
Complete list in www.artago.com

LOCKED



PEUGEOT DJANGO 50/125/150 '14>

TRANSPORT



KYMCO K-XCT 125i-300i '13>

ES Ficha técnica

- El **tope de gama** de la seguridad más práctica para scooter.
- Cuerpo de cierre blindado y giratorio.
- Cerradura ART+ anti-ganzúa con disco anti-taladro 5mm.
- Cable de acero, blindado con casquillos y bolas de acero.
- Apertura lateral con tapa anti-polvo y anti-humedad.
- Integrado con soporte fijación para cada scooter.
- Disponible el servicio de cerradura con la **MISMA COMBINACIÓN ART+** (SMC) para todos tus antirrobo.

FR Fiche technique

- **Le haut gamme des antivols "practic"** spécial scooter.
- Corps de fermeture blindé et giratoire.
- Serrure ART+ anticrochetage et disque antiperçage de 5mm.
- Câble intérieur en acier blindé de rotules et billes en acier.
- Cache de protection contre la poussière et l'humidité.
- Avec support de fixation adapté à chaque scooter.
- Disponible le service **MÊME SERRURE ART+** (SMC) pour vos autres antivols.

EN Technical features

- **The high-end** of the most practical scooter security.
- Armored and revolving body-lock.
- Antipicking ART+ locking with 5mm anti-drilling disk.
- Steel wire, armored with steel cylinders and balls.
- Anti-dust and anti-humidity cover.
- Integrated with fixation bracket for each scooter.
- ART+ **SAME KEY COMBINATION** (SMC) service available for your next locks.

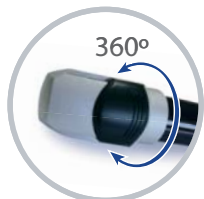

ref. JMA STS-X6



Refer.

...STY

Según el MODELO Y AÑO de tu scooter
Selon le modèle et l'année de votre scooter
Depending on the model and year of your scooter
Complete list in www.artago.com

LOCKED



SUZUKI BURGMAN 400 '17>

TRANSPORT



HONDA FORZA 125/300i '18>

ES Ficha técnica

- Cuerpo de cierre blindado y giratorio, más seguro y práctico.
- Apertura lateral con tapa anti-polvo y anti-humedad.
- Cerradura de seguridad con llave de puntos reversible.
- Totalmente integrado, con soporte fijación para cada scooter.
- Cable de acero, blindado con casquillos y bolas de acero.

FR Fiche technique

- Corps de fermeture blindé et giratoire.
- Serrure de sécurité avec clé plate à points réversible.
- Avec support de fixation adapté à chaque scooter.
- Cache de protection contre la poussière et l'humidité.
- Câble intérieur en acier blindé de rotules et billes en acier.

EN Technical features

- Armored and revolving body-lock, safer and more practical.
- Anti-dust and anti-humidity cover.
- Security lock with flat key reversible.
- Completely integrated, with fixation support for each scooter.
- Steel wire, armored with steel cylinders and balls.



Artago Secure s.l. *security factory*

CIF: B46658944 / TVA INTRA: ESB46658944

C/ Gregal, 1 - Pol. Industrial Ciutat Carlet - E-46240 Carlet - VALENCIA - Spain

Tel. (+34) 962 533 001 - Fax. (+34) 962 532 463 - At. Client: 8-13:30h , 15-18h.

www.artago.com - artago@artago.com



MADE IN VALENCIA
EUROPEAN QUALITY