



**EVOTECH**<sup>®</sup>  
P E R F O R M A N C E

**KTM 125/200/390 Duke**

**Tail Tidy**

**Installation Instructions**



## Kit Contents PRN013771

- A** 1 x L/H Arm
- B** 1 x R/H Arm
- C** 1 x Base Plate
- D** 1 x Cover Plate
- E** 1 x Number Plate Bracket
- F** 1 x Reflector Kit
- G** 1 x M5 Cover Cap
- H** 1 x M6 x 16 Countersunk Screw
- I** 1 x M5 x 10 Caphead Scew
- J** 2 x M5 x 16 Button Head Bolts
- K** 2 x Indicator Stems
- L** 2 x 4mm Dowel Pins
- M** 2 x Indicator Screws
- N** 3 x M6 x 16 Cross Dowels
- O** 6 x M6 x 16 Button Head Bolts

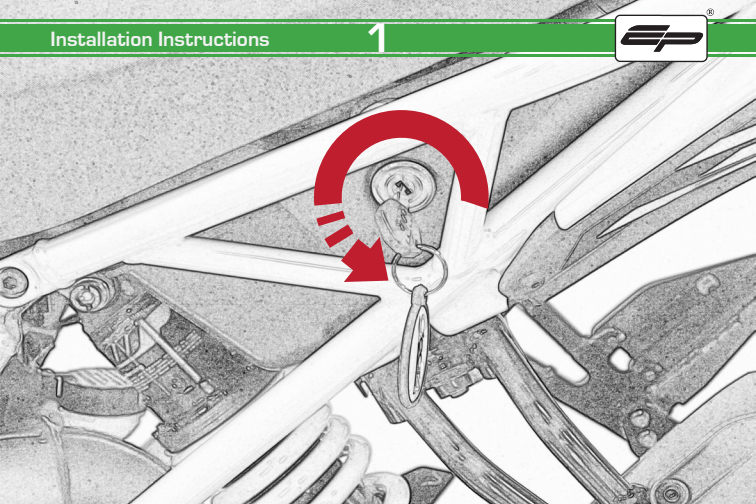

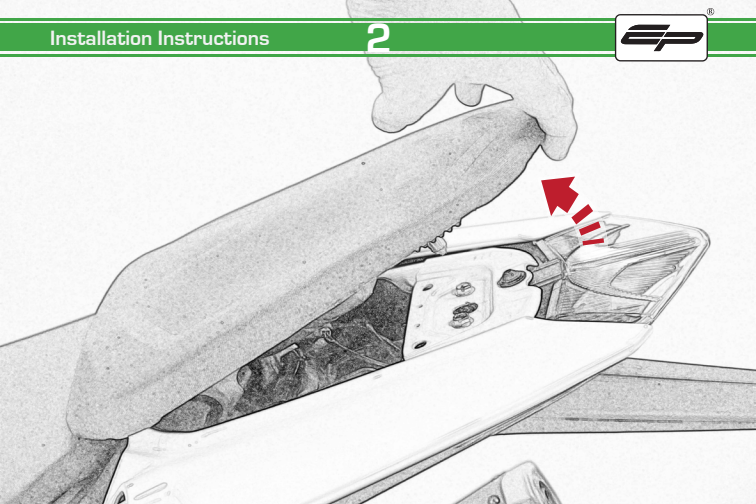

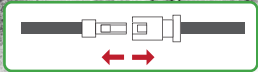
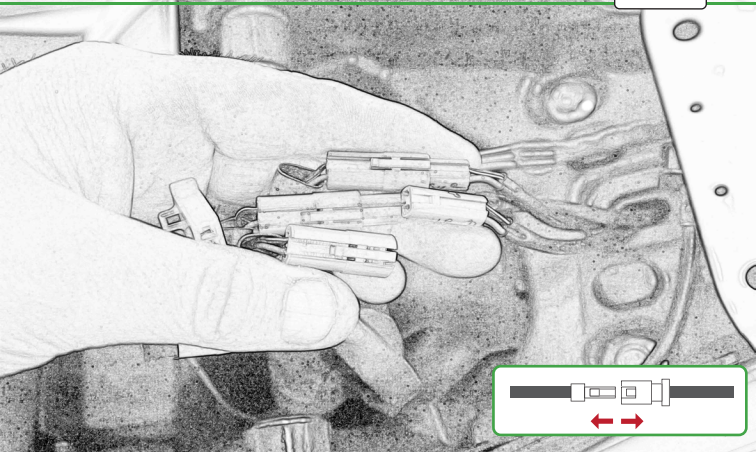



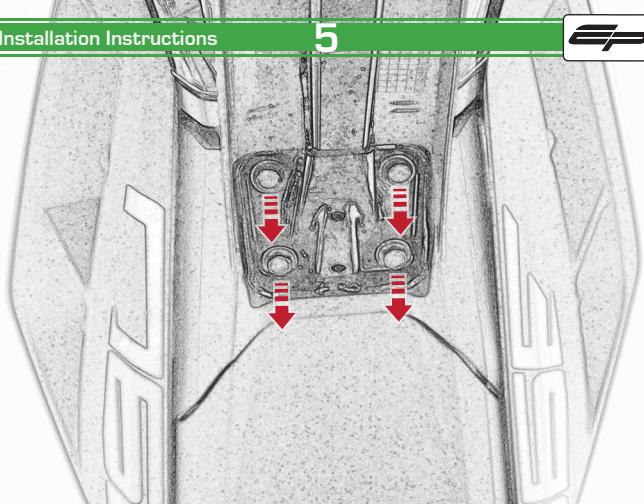

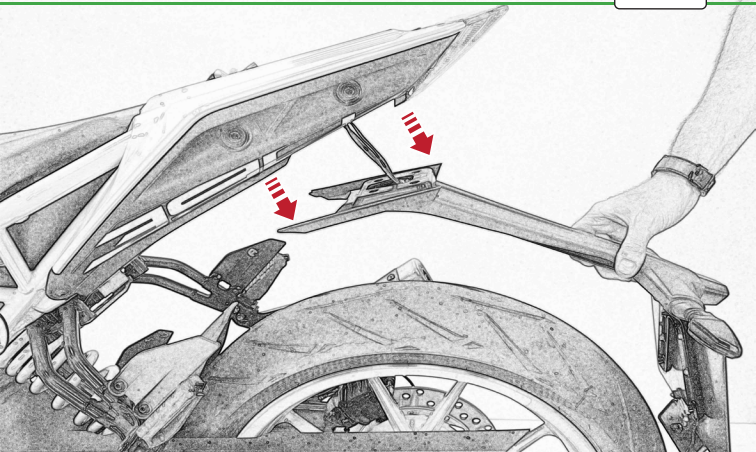



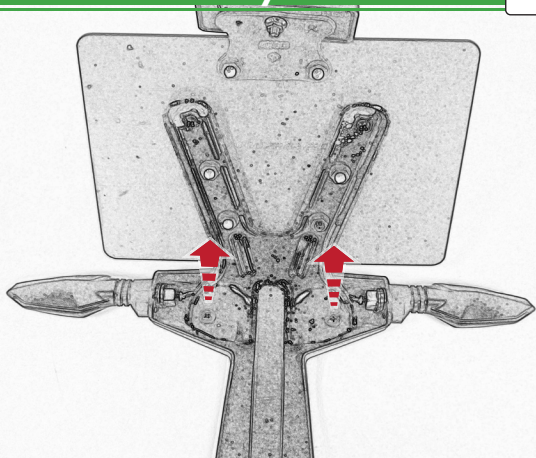

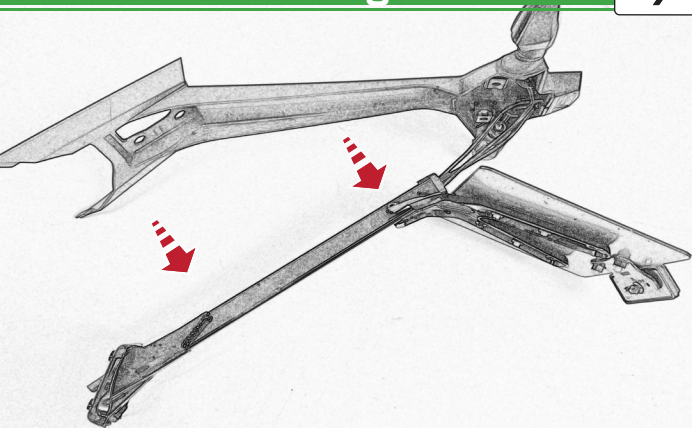

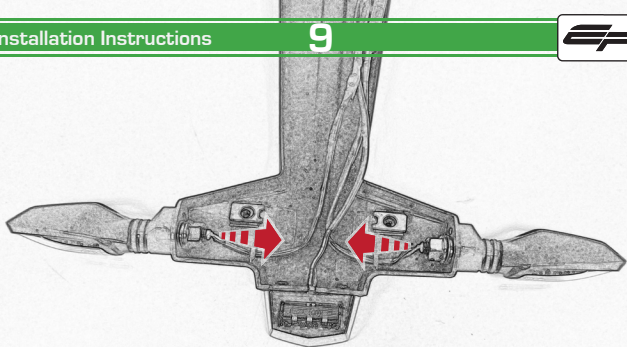

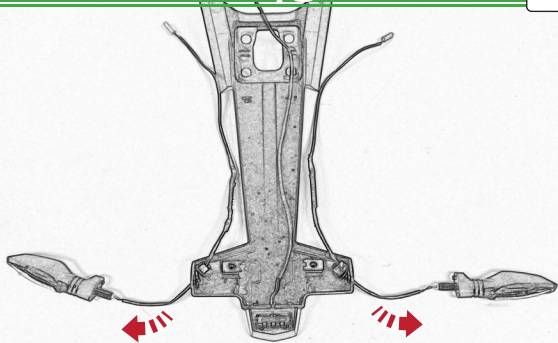

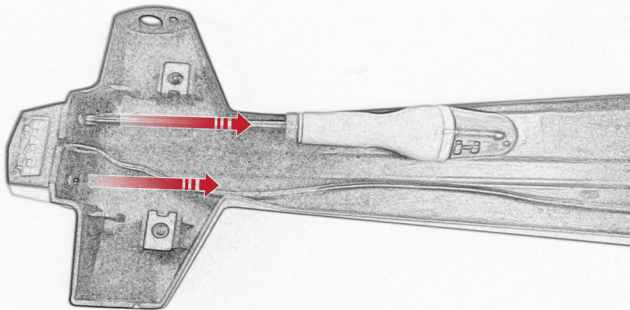

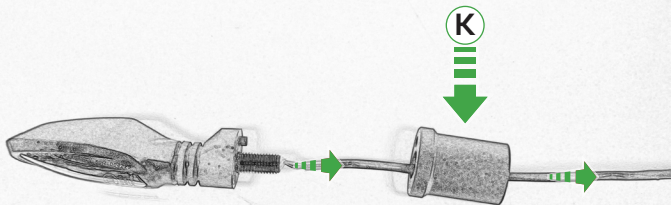

Repeat  
Both Side

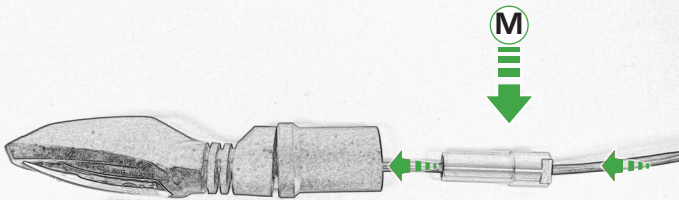

Repeat  
Both Side

Fully Tighten

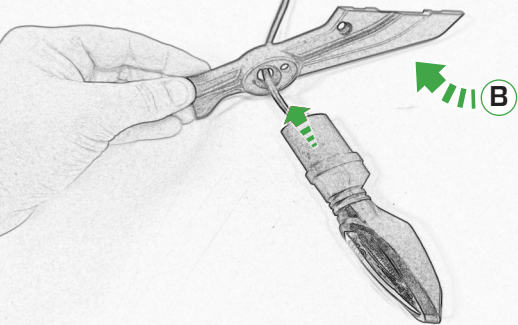

Repeat  
Both Side



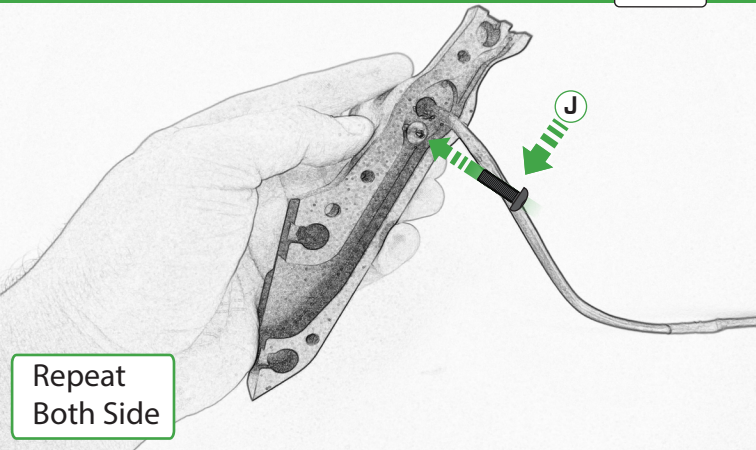

Repeat  
Both Side

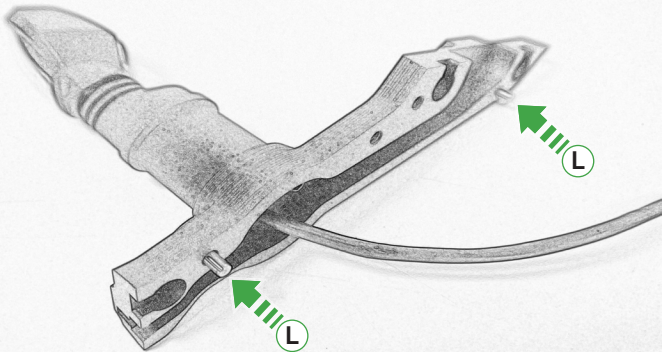

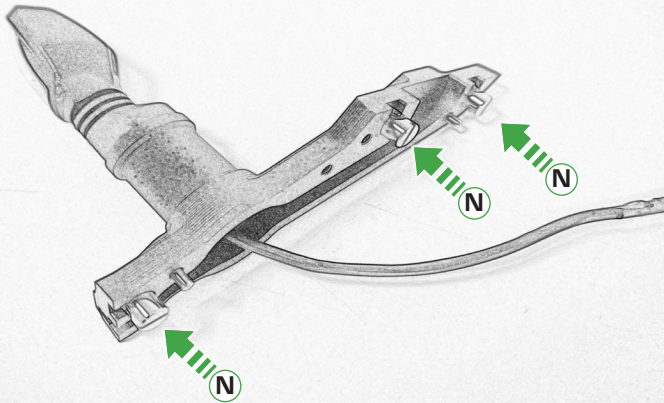

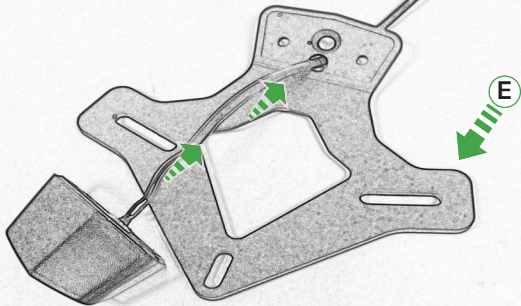

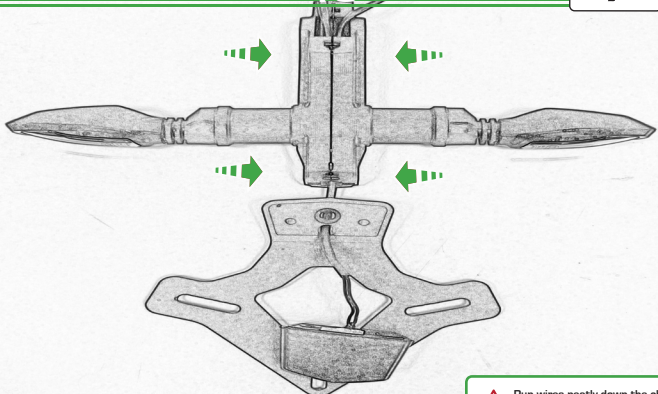

Caution

Run wires neatly down the channel in both parts ensuring they do not get trapped or squashed

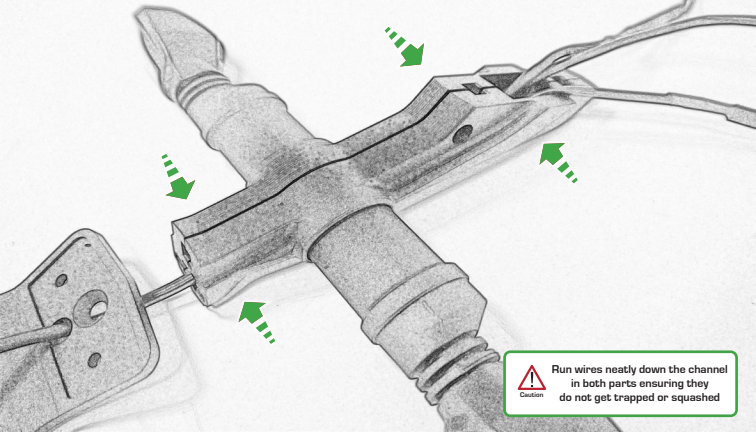

Caution

Run wires neatly down the channel  
in both parts ensuring they  
do not get trapped or squashed

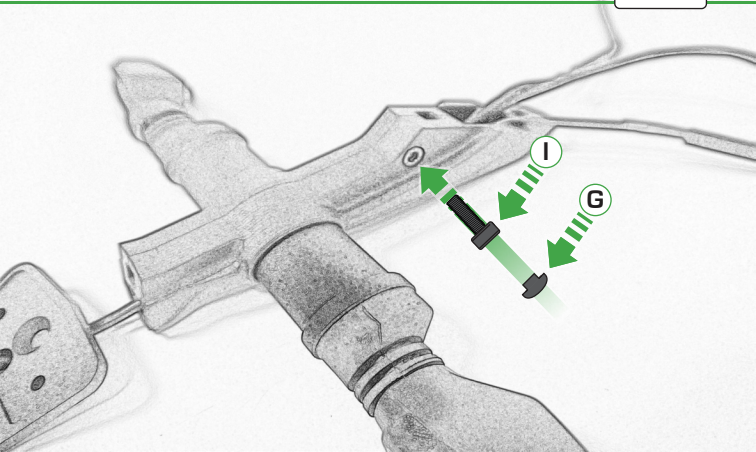

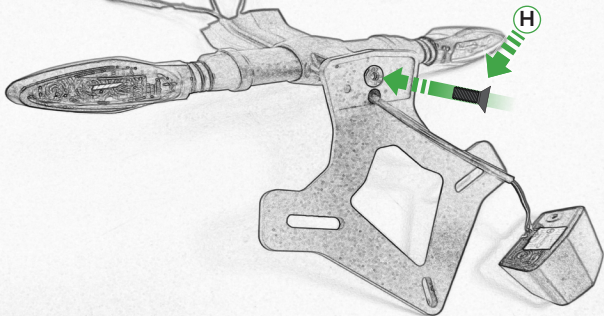



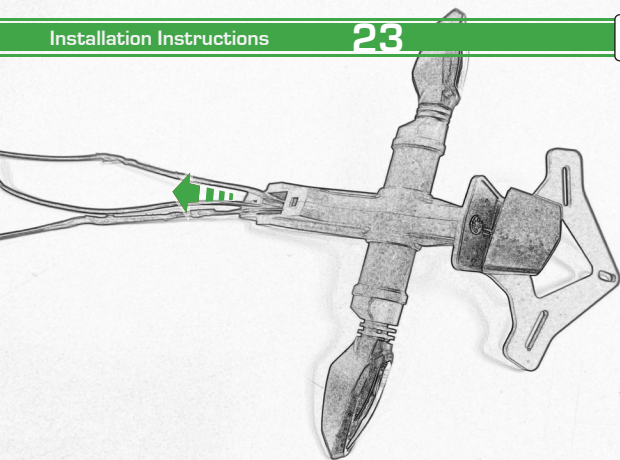

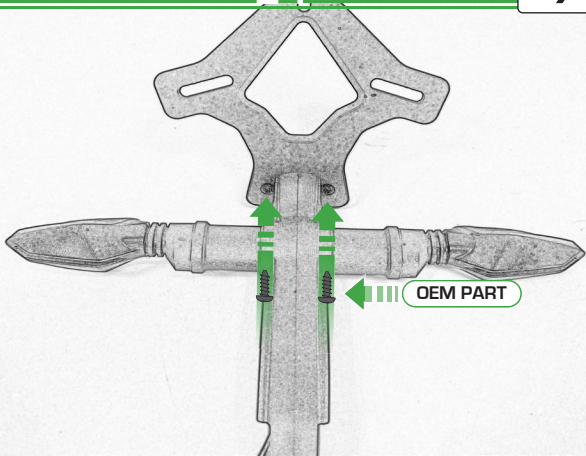

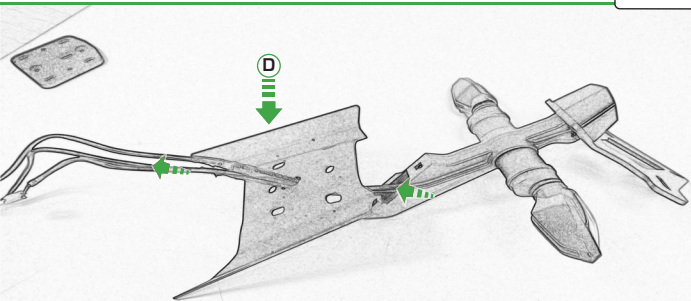

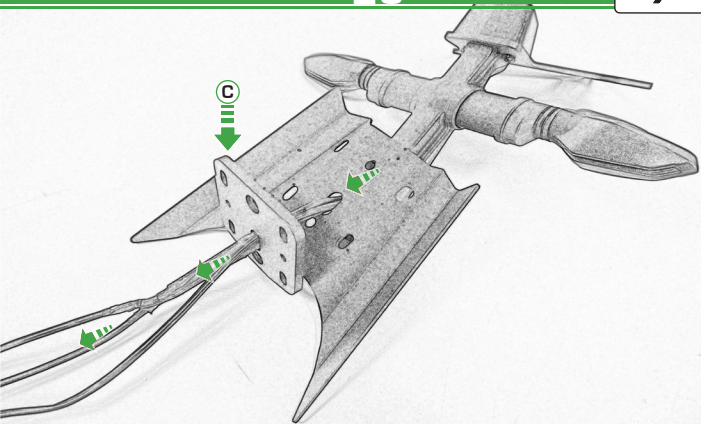

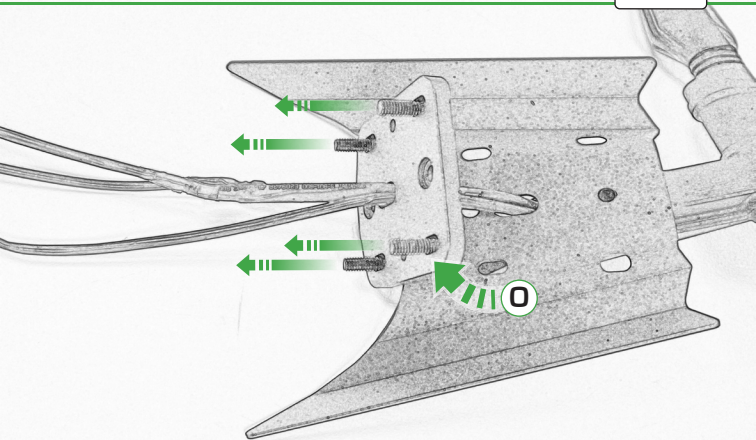

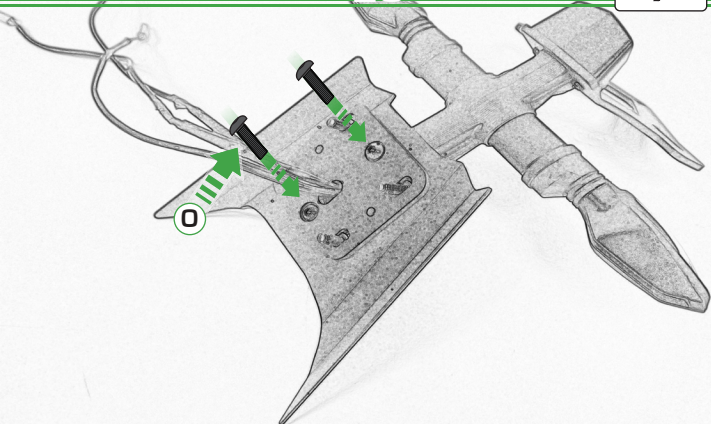

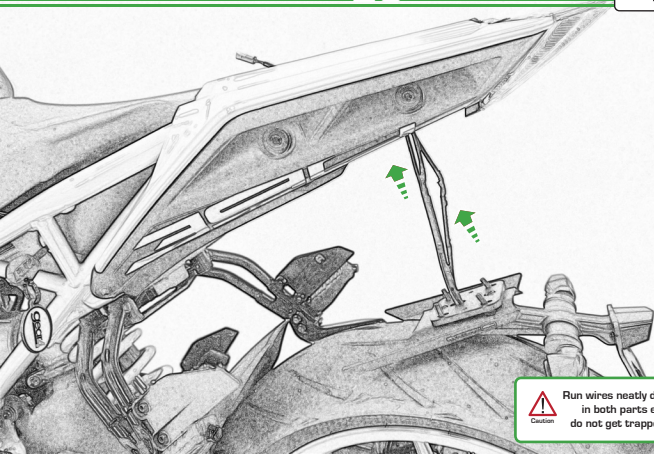

Caution

Run wires neatly down the channel  
in both parts ensuring they  
do not get trapped or squashed

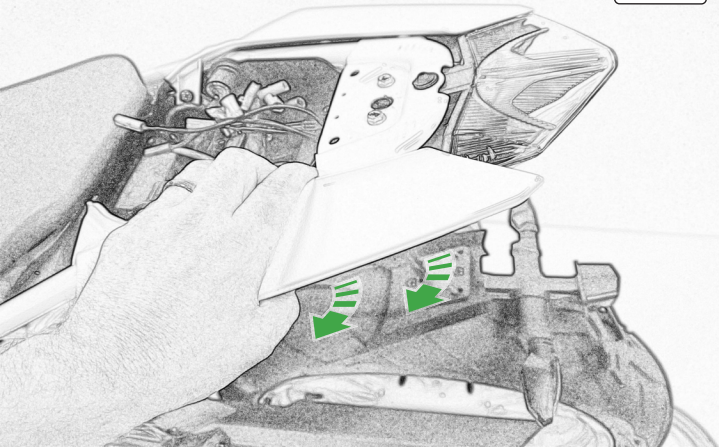



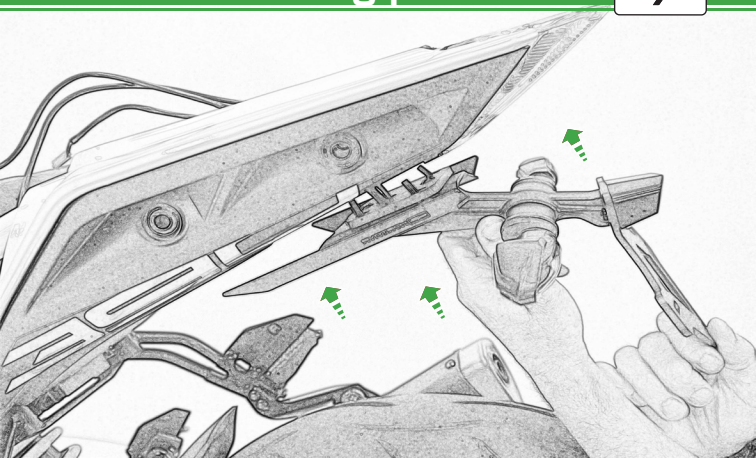

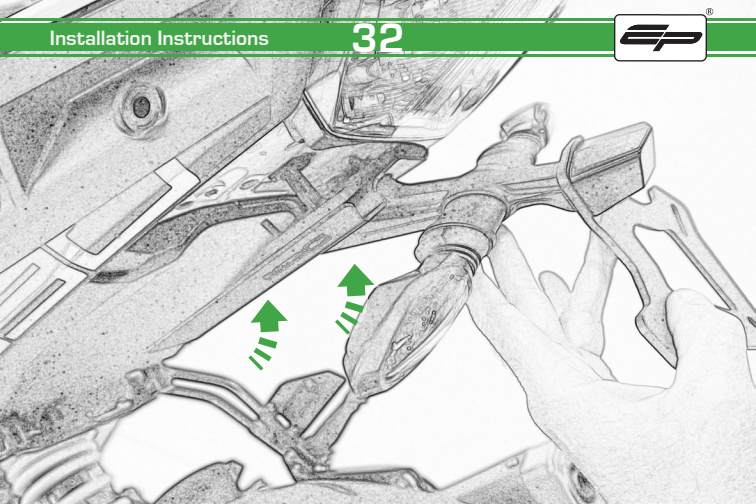

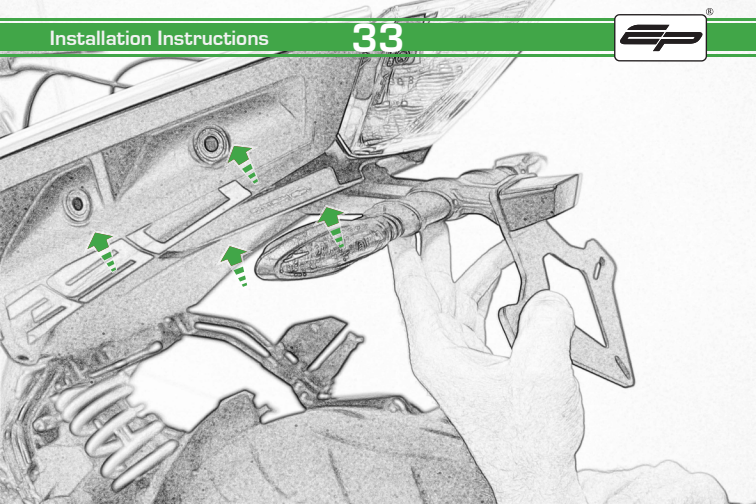

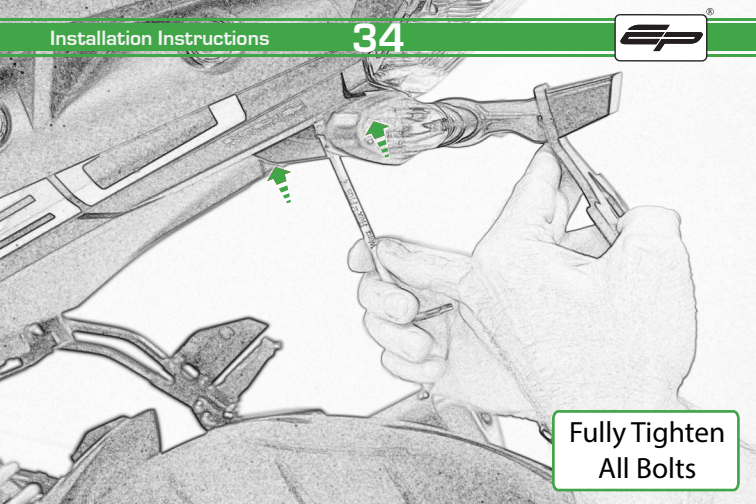

Fully Tighten  
All Bolts

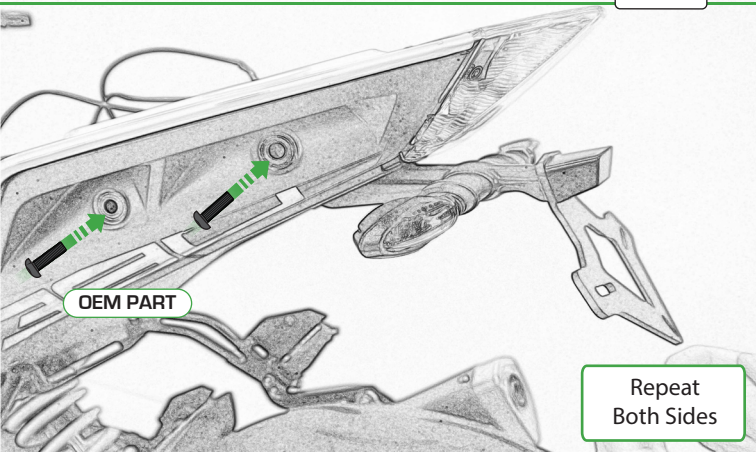

OEM PART

Repeat  
Both Sides



Reverse Stages

3 - 1

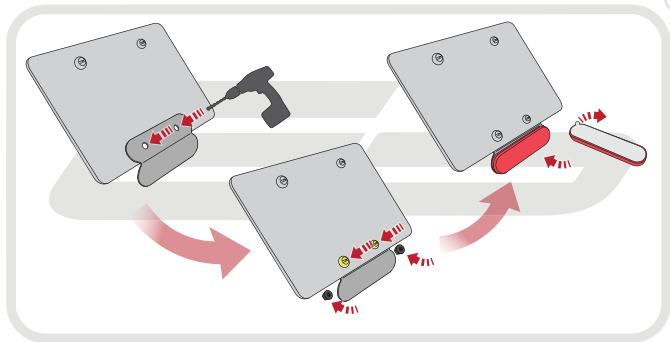

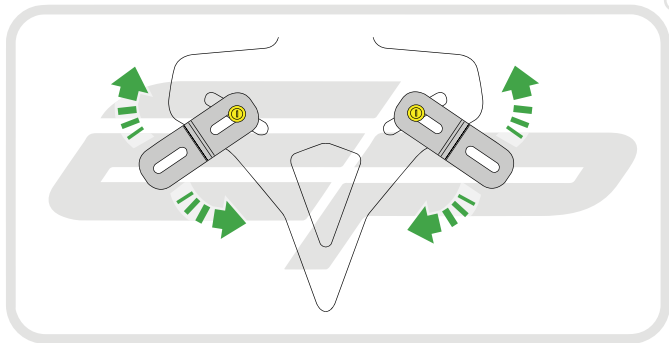



### **ESSENTIAL CHECKS**

After installation of your tail tidy ensure that the licence plate does not contact the rear tyre when suspension is fully compressed.

Ensure all electrics including indicators, tail light, brake light and licence plate light lights are working correctly before riding the motorcycle.

It is recommended that periodic inspections are made to ensure that all fixings are fully tightend.



**EVOTECH**®  
P E R F O R M A N C E

[www.evotech-performance.com](http://www.evotech-performance.com)