



Kawasaki Z900 RS
Tail Tidy

Installation Instructions



Kit Contents PRN013913

- A** 1 x Reflector Kit
- B** 2 x Grommets
- C** 2 x Indicator Mounts
- D** 3 x P-Clips
- E** 4 x M6 Flange Nuts
- F** 4 x Plastic Spacers
- G** 11 x M4 x 8 Black Button Heads

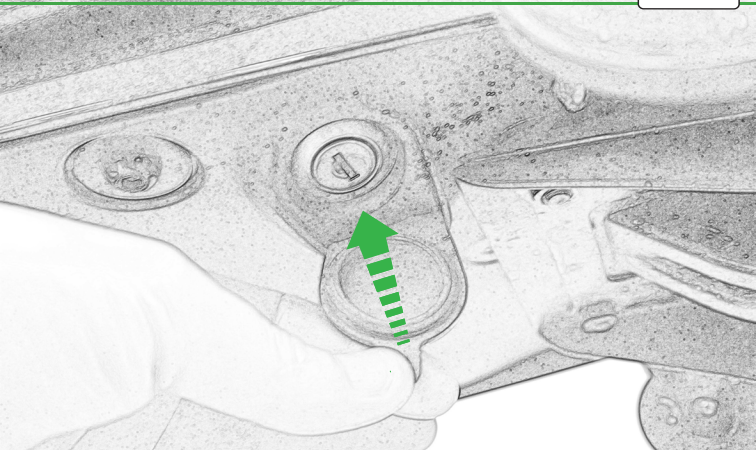

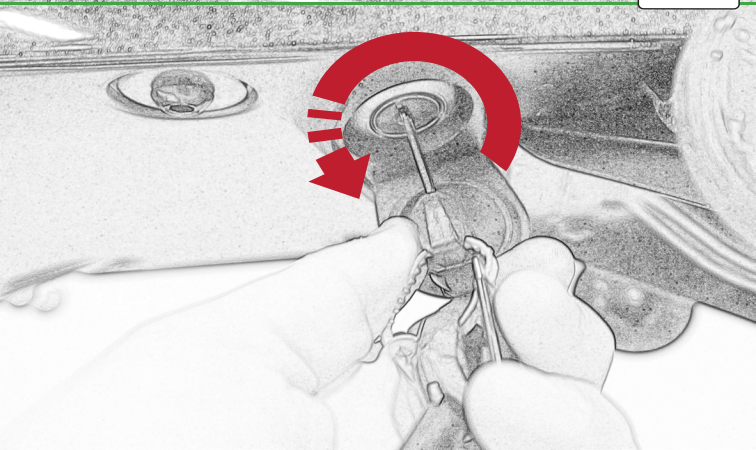

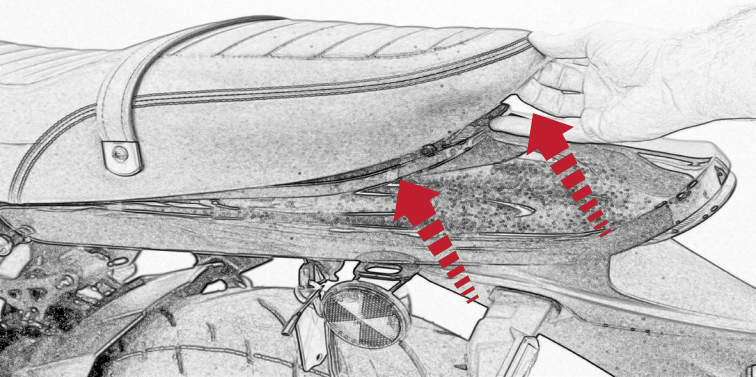

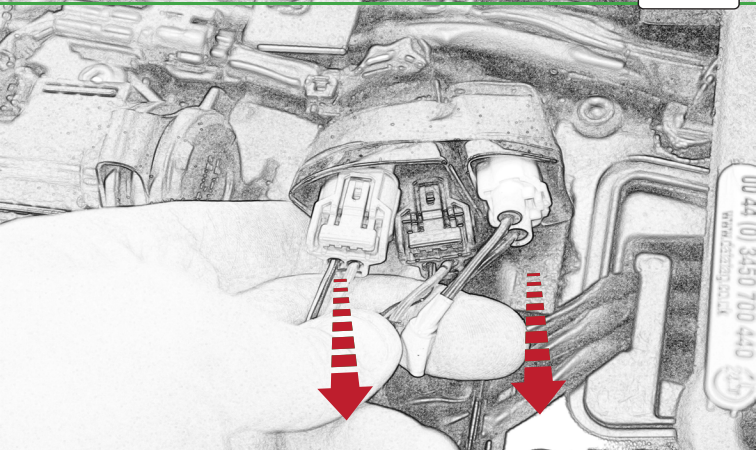

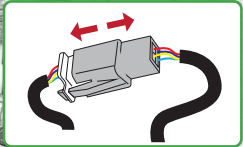
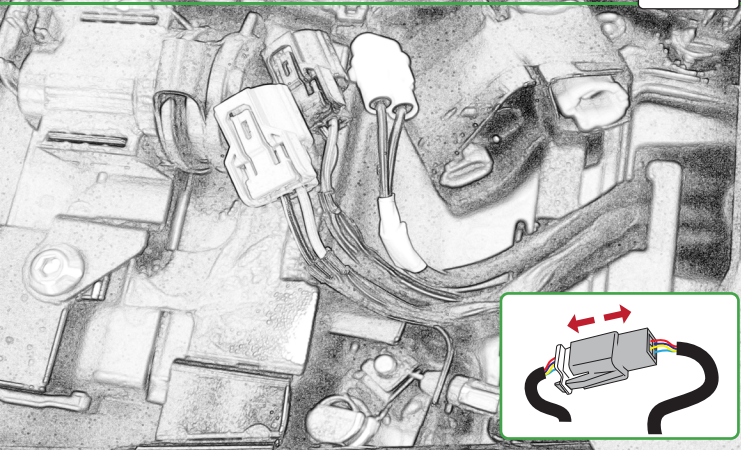

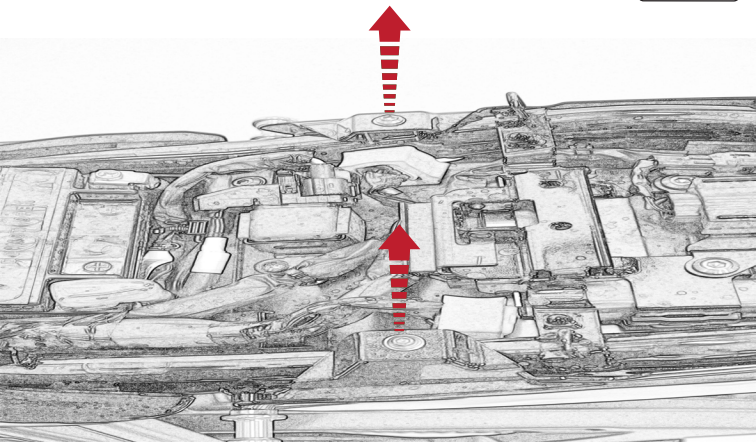

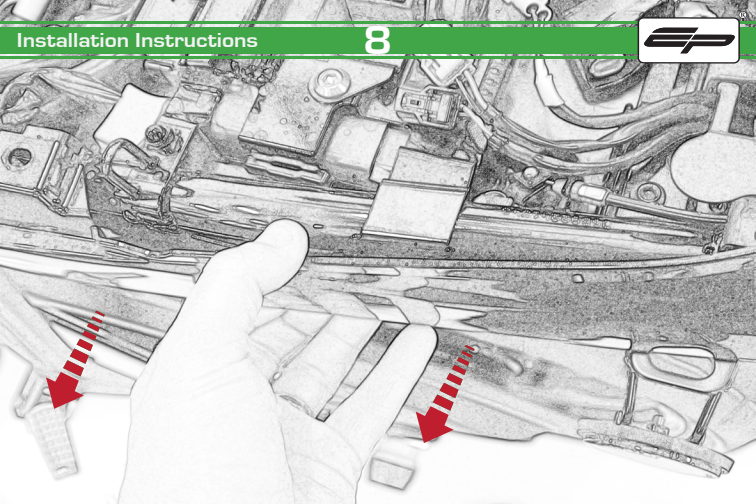



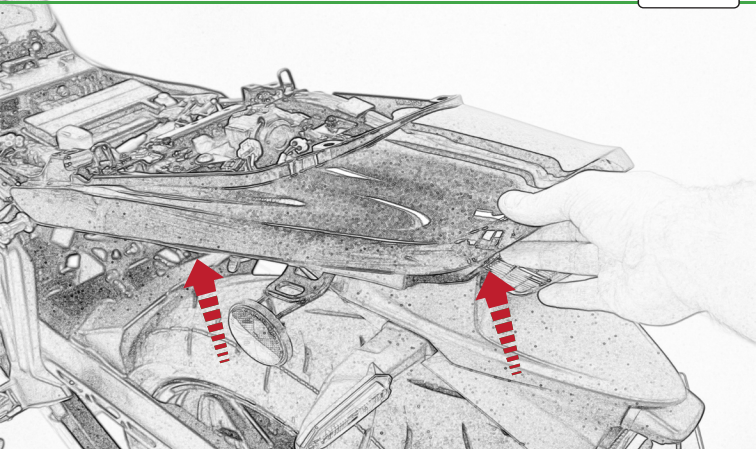

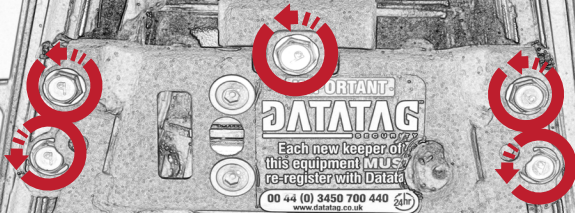

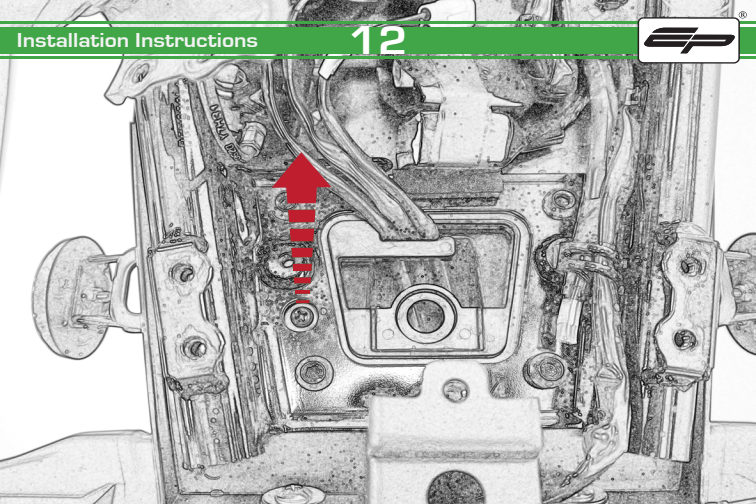

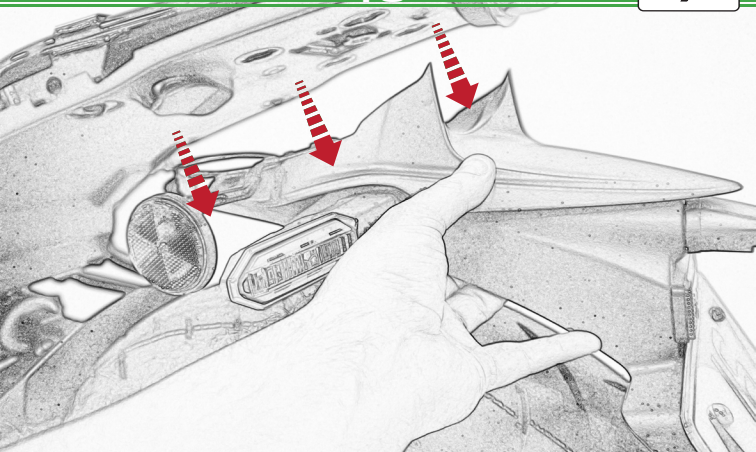

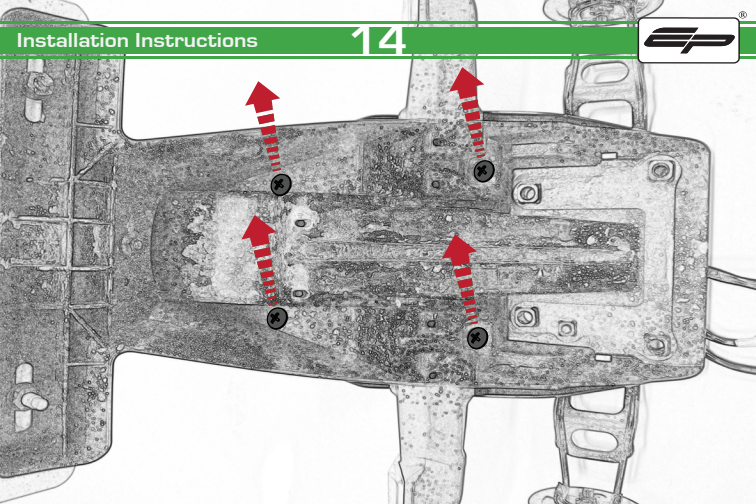

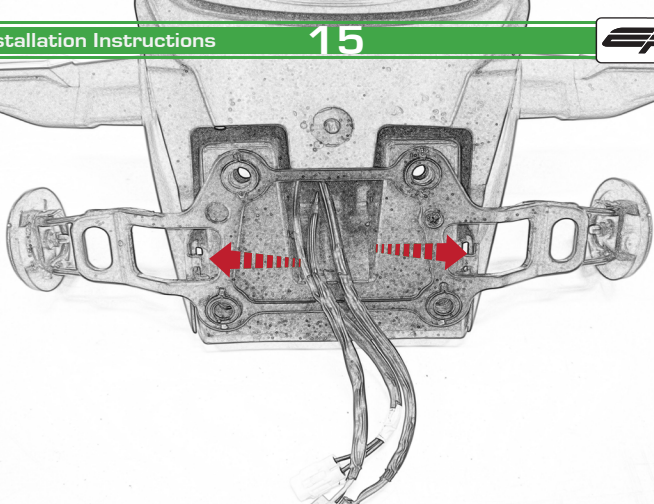

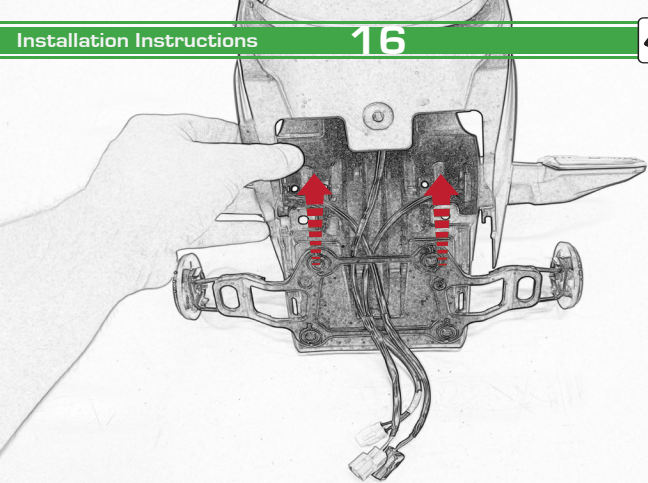

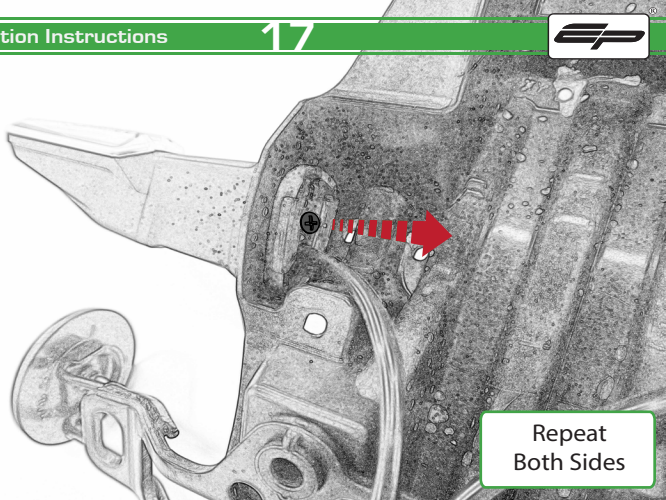

Repeat
Both Sides

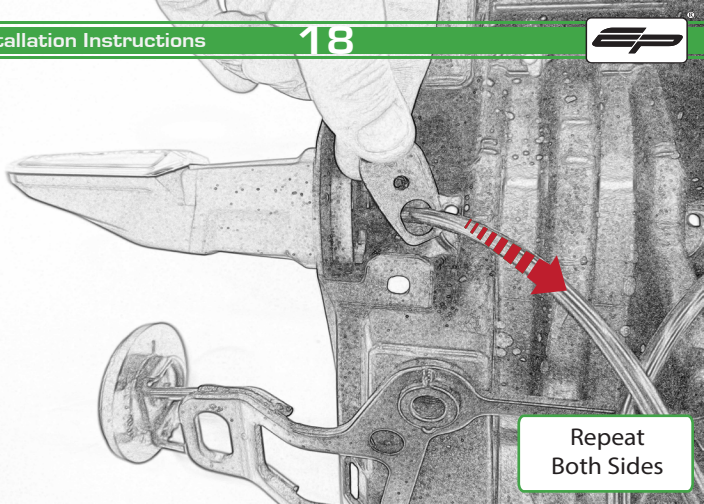

Repeat
Both Sides

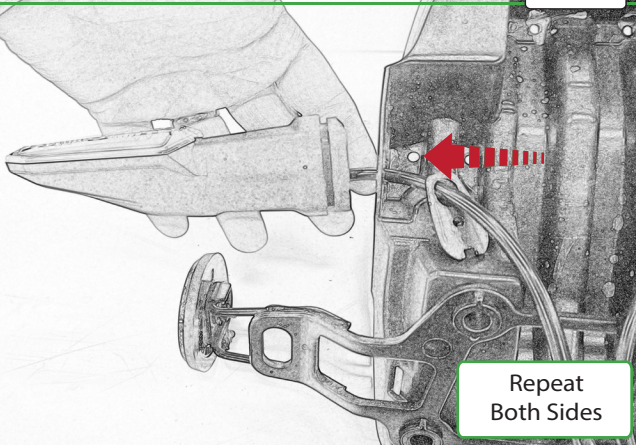

Repeat
Both Sides

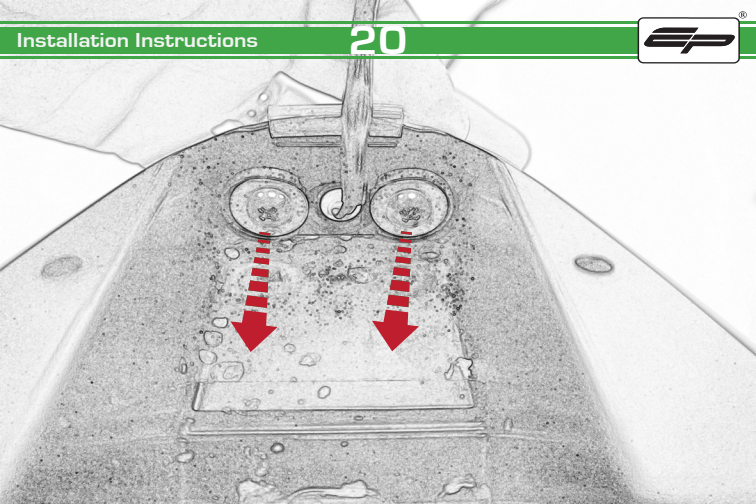

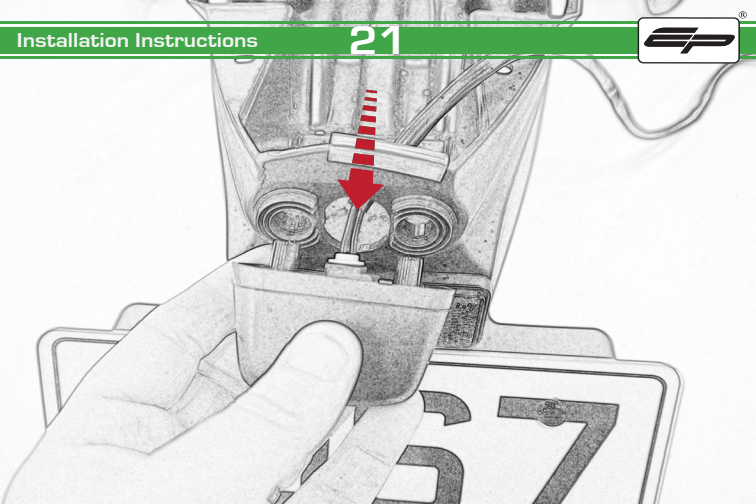

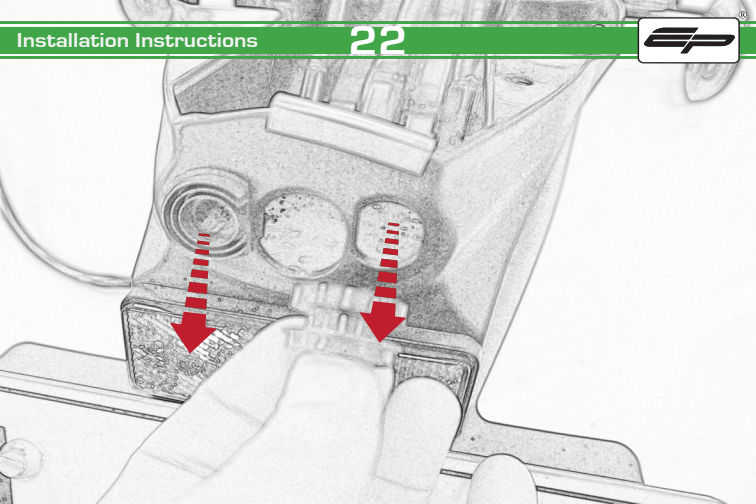

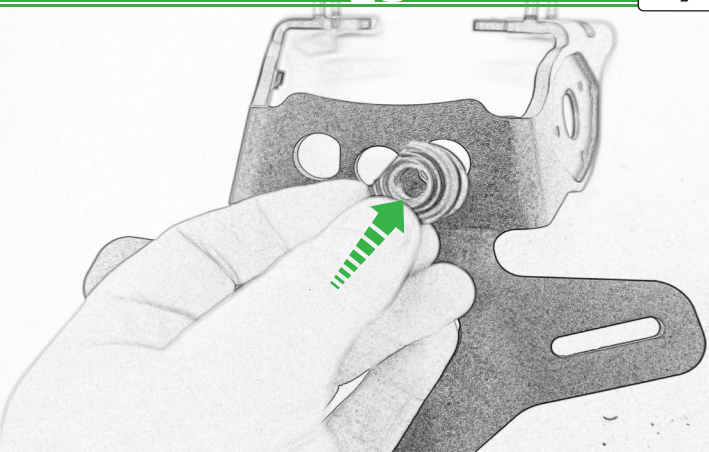

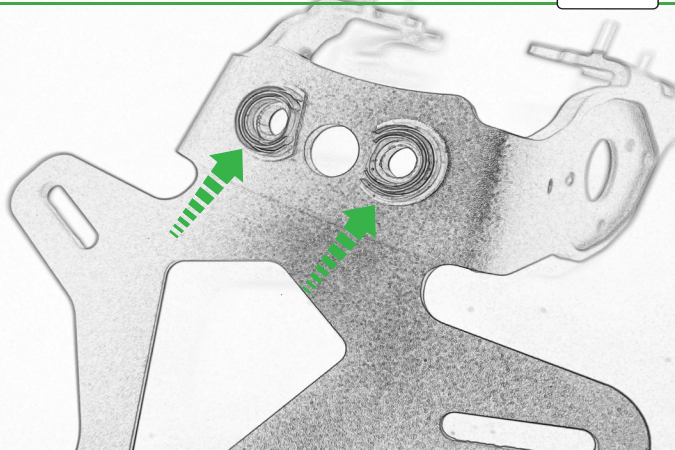

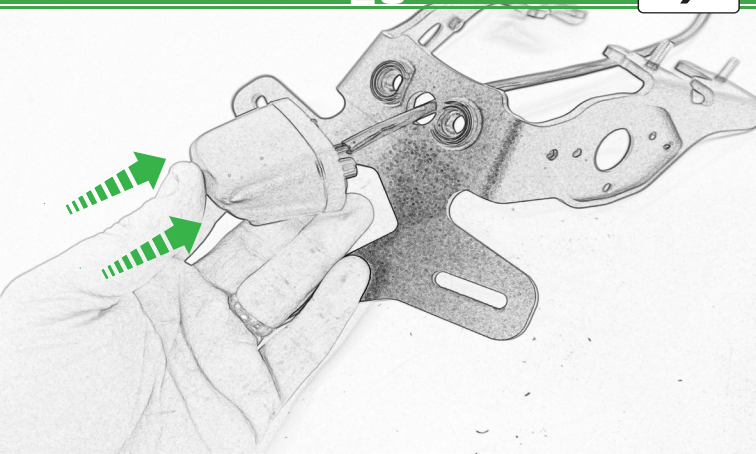

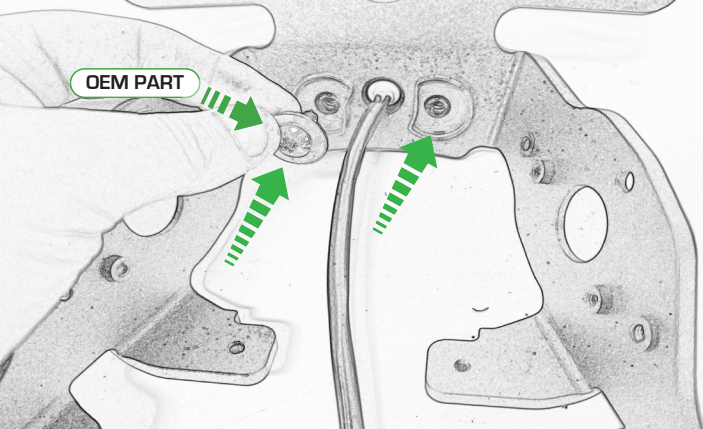

OEM PART

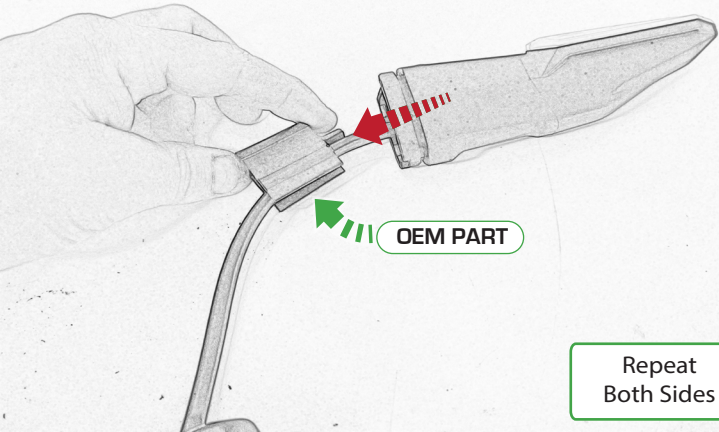

OEM PART

Repeat
Both Sides

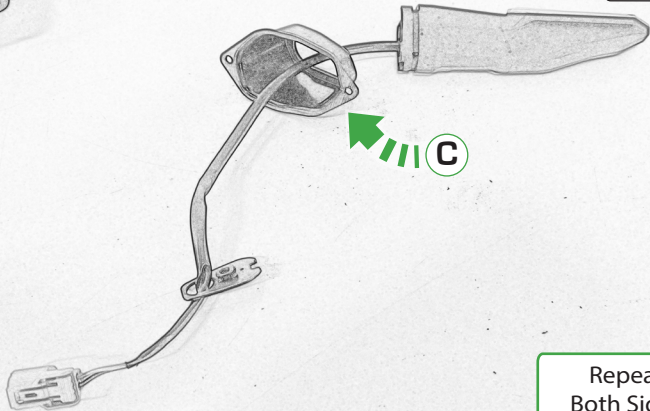

Repeat
Both Sides

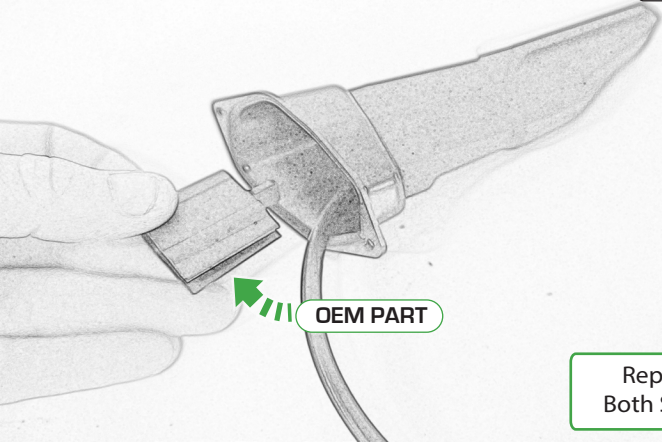

OEM PART

Repeat
Both Sides



Repeat
Both Sides



OEM PART



Repeat
Both Sides

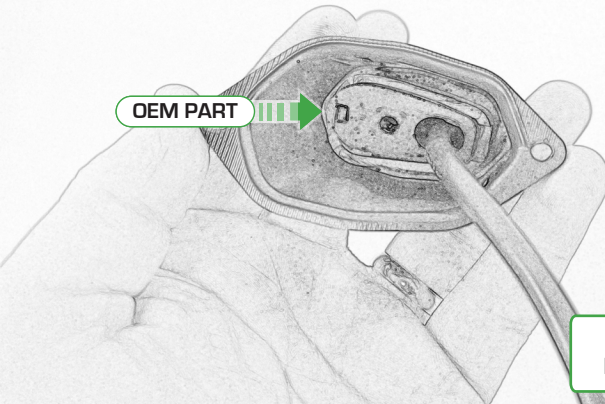

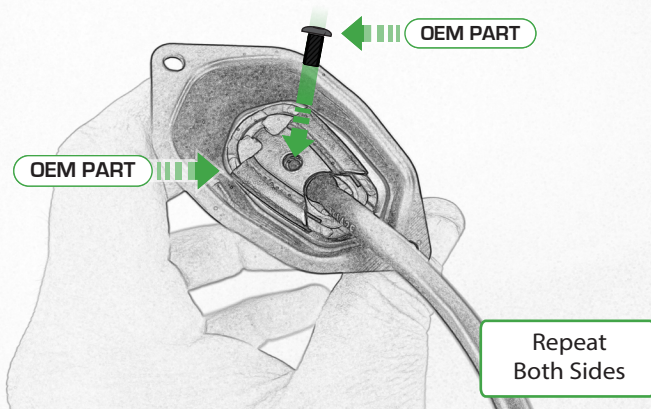

OEM PART

OEM PART

Repeat
Both Sides

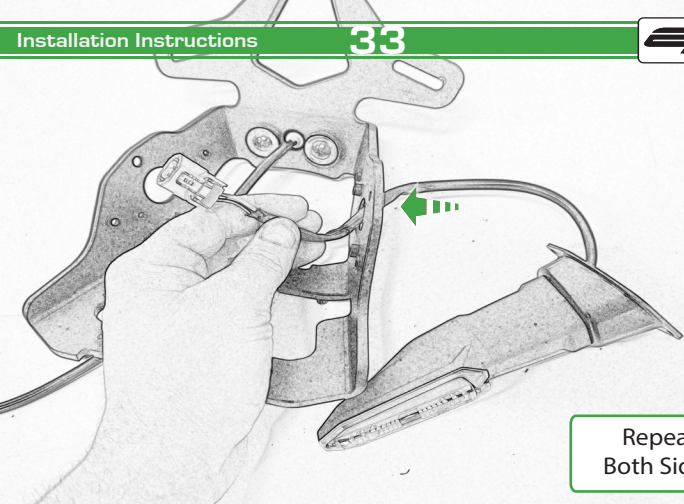

Repeat
Both Sides

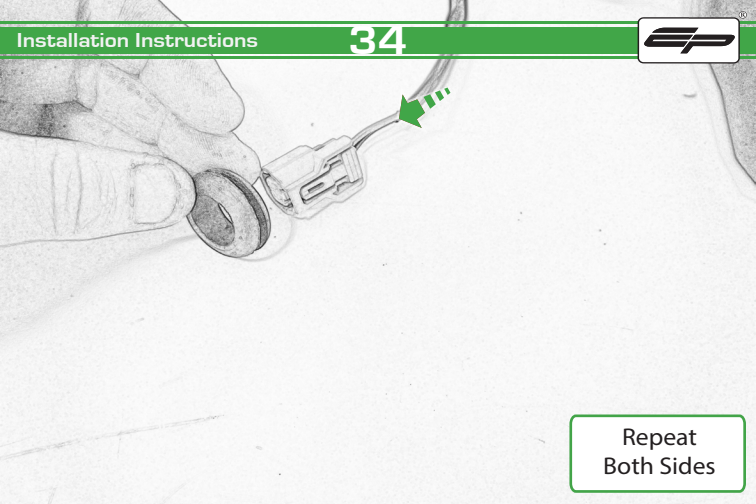

Repeat
Both Sides

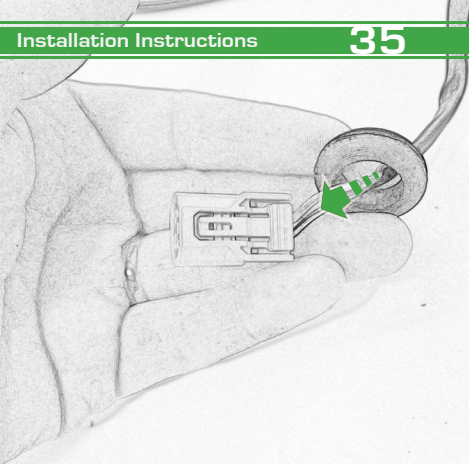

Repeat
Both Sides

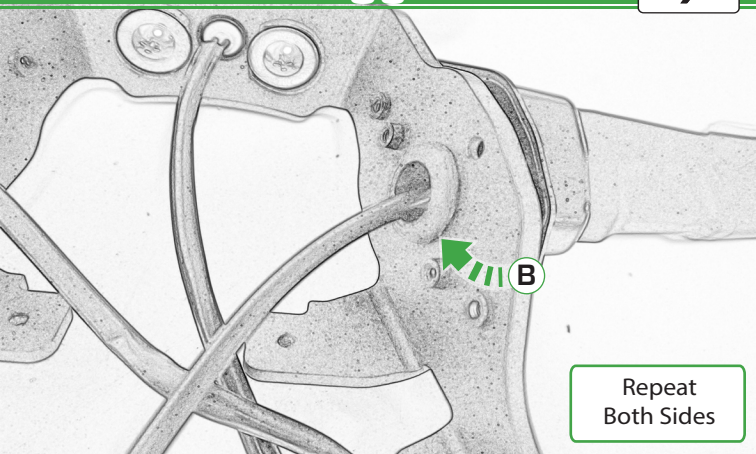

Repeat
Both Sides

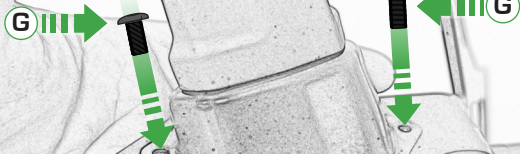

Repeat
Both Sides

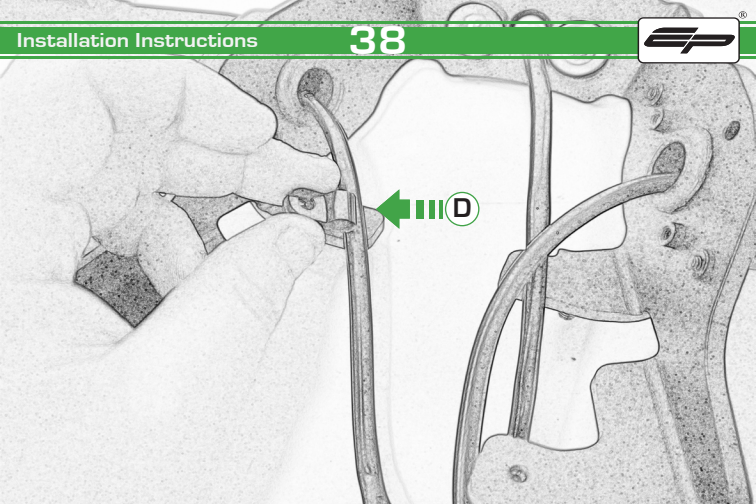

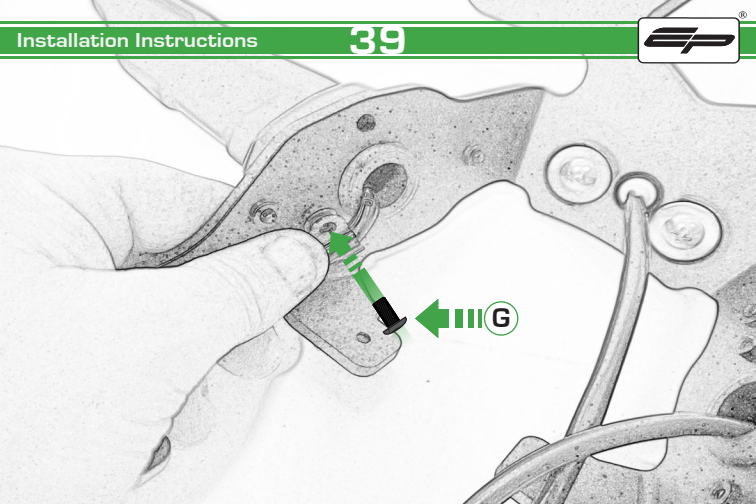

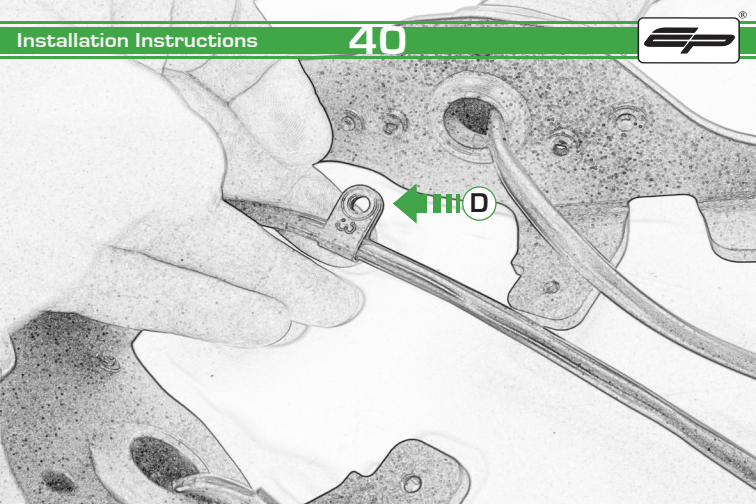

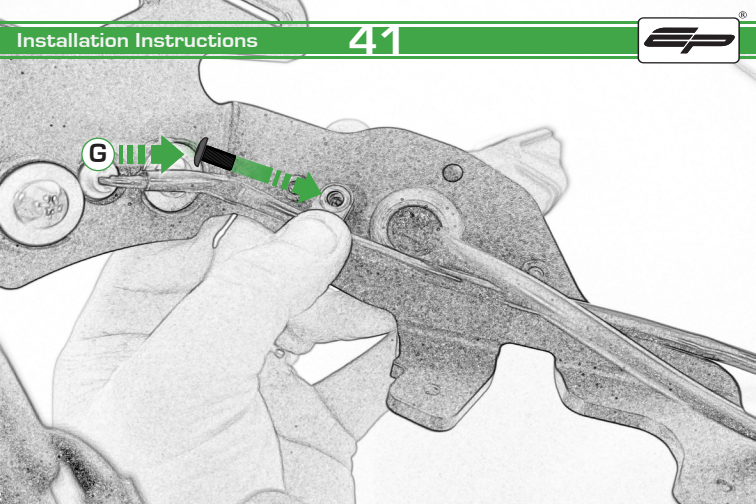

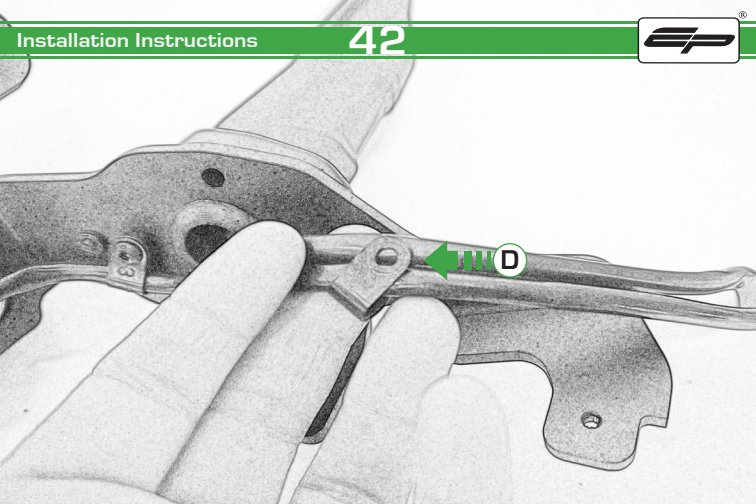

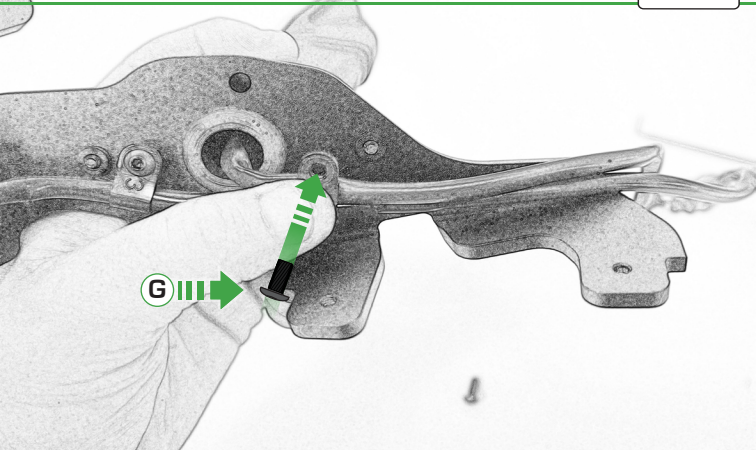

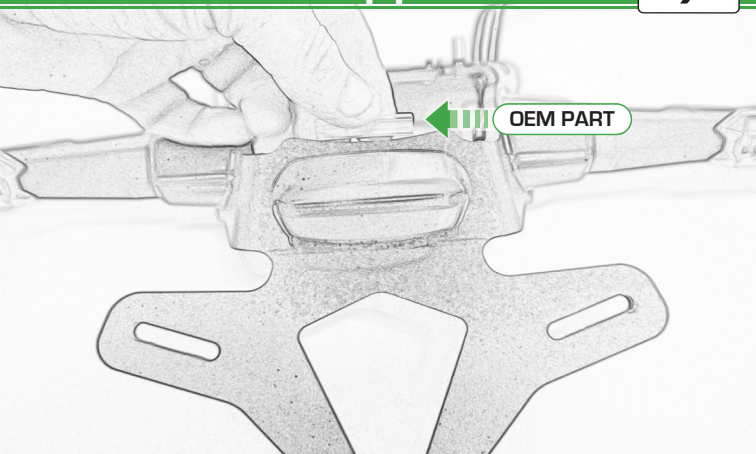

OEM PART

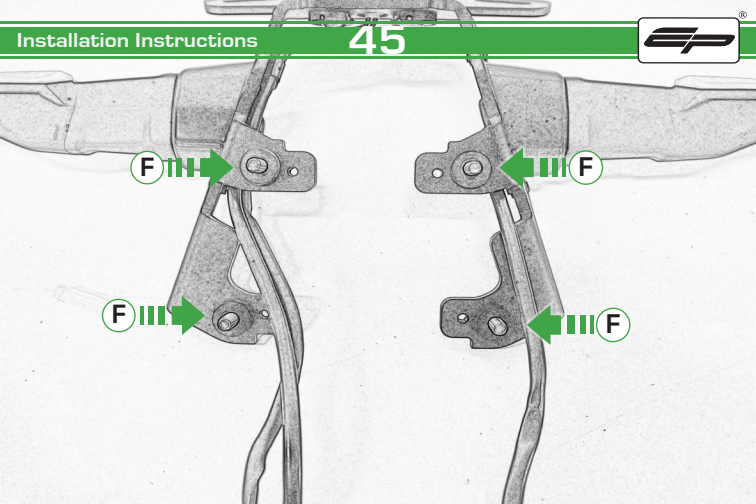

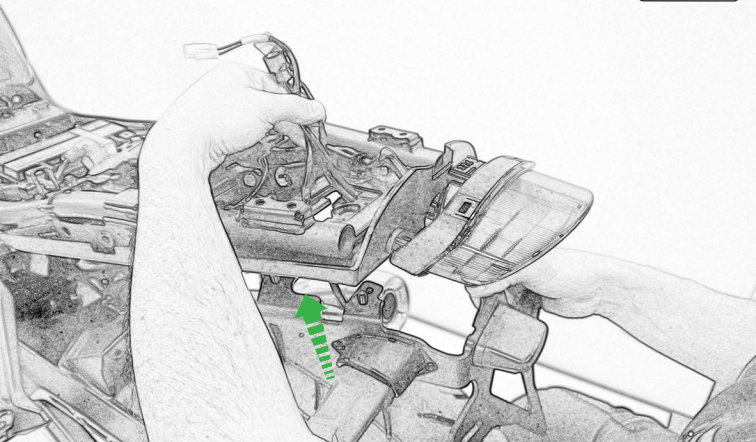

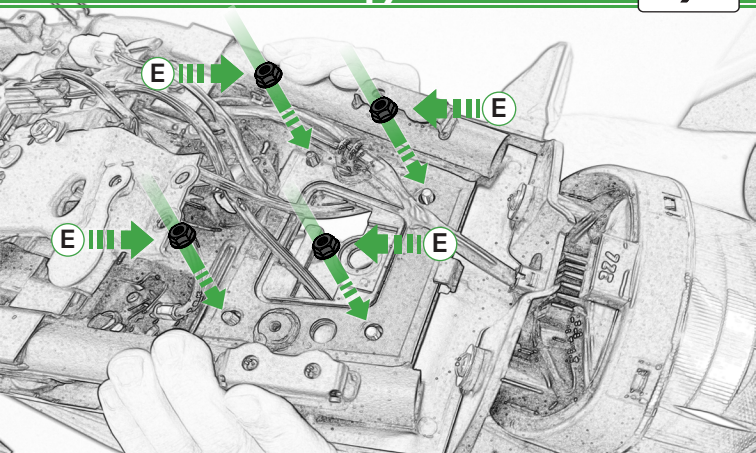

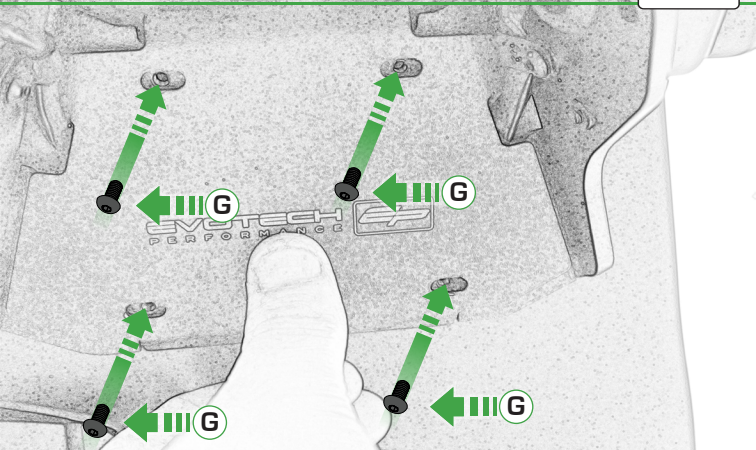

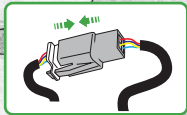

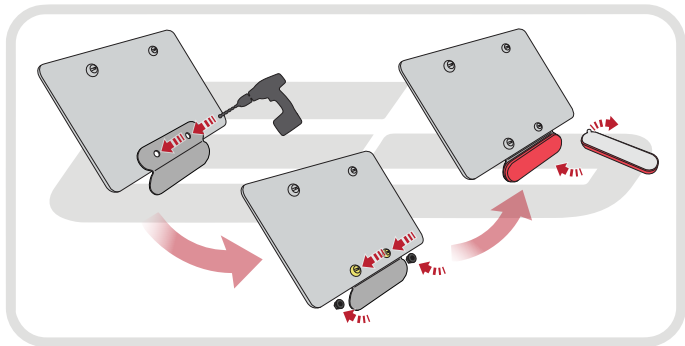

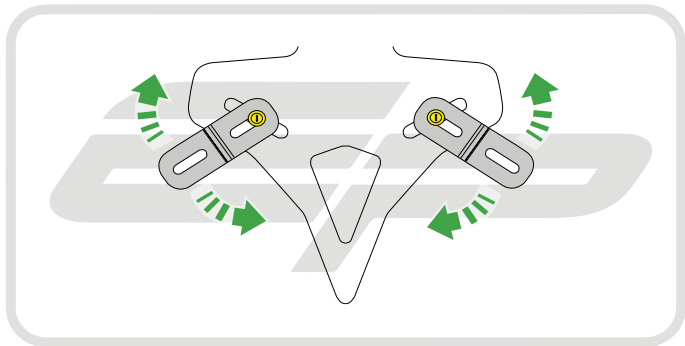



ESSENTIAL CHECKS

After installation of your tail tidy ensure that the licence plate does not contact the rear tyre when suspension is fully compressed.

Ensure all electrics including indicators, tail light, brake light and licence plate light lights are working correctly before riding the motorcycle.

It is recommended that periodic inspections are made to ensure that all fixings are fully tightend.



EVOTECH®
P E R F O R M A N C E

www.evotech-performance.com