



EVOTECH[®]
P E R F O R M A N C E

Husqvarna Vitpilen
Tail Tidy

Installation Instructions



Kit Contents PRN014052

- (A) 1 x Reflector Kit
- (B) 1 x Rubber Cap
- (C) 1 x Grommet
- (D) 1 x Chain Adjuster Block
- (E) 2 x Indicator Stem
- (F) 2 x Indicator Nut
- (G) 2 x M5 x 10 Caphead Bolts
- (H) 2 x M5 x 12 Caphead Bolts
- (I) 2 x M5 x 10 C/sink Screws
- (J) 2 x 4mm Dowel Pins
- (K) 4 x M8 x 20 Black Button Head Bolts

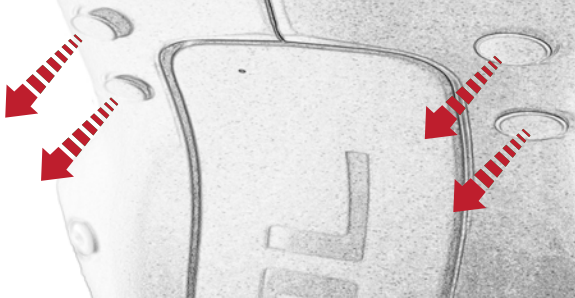

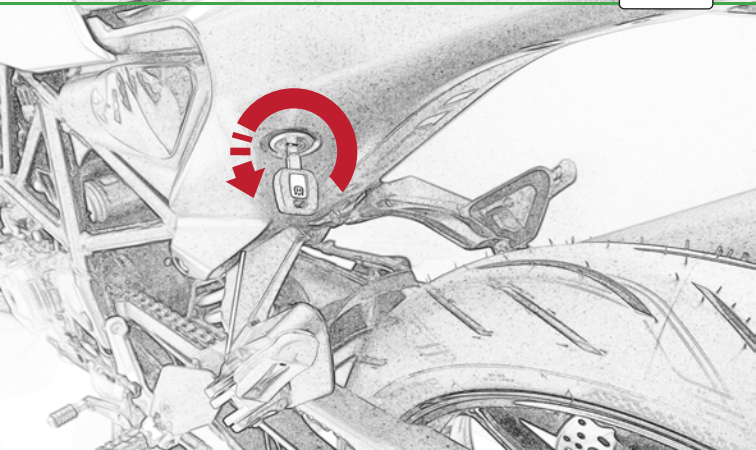

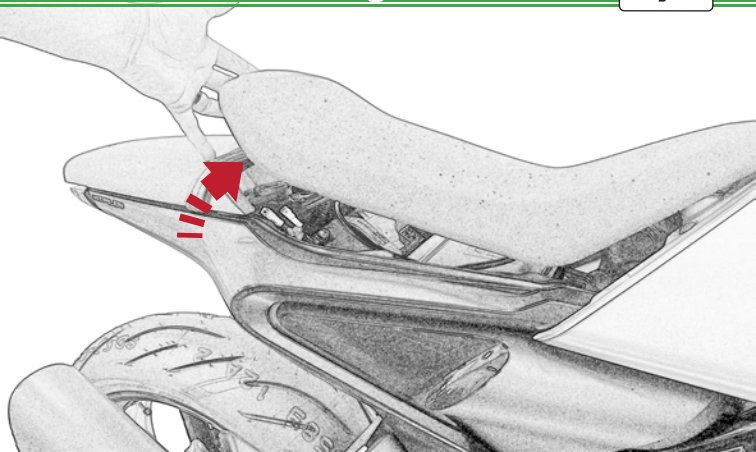

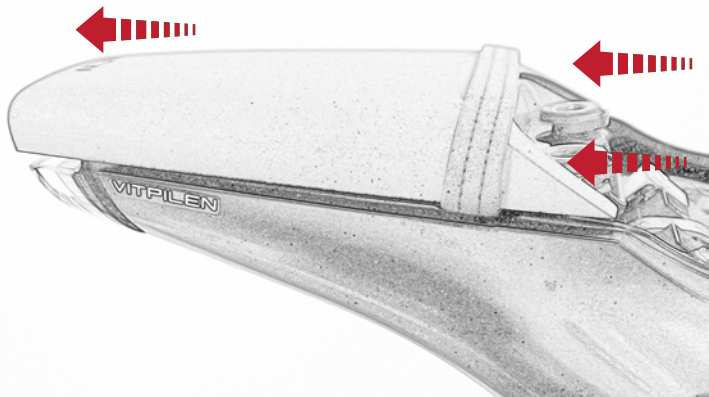

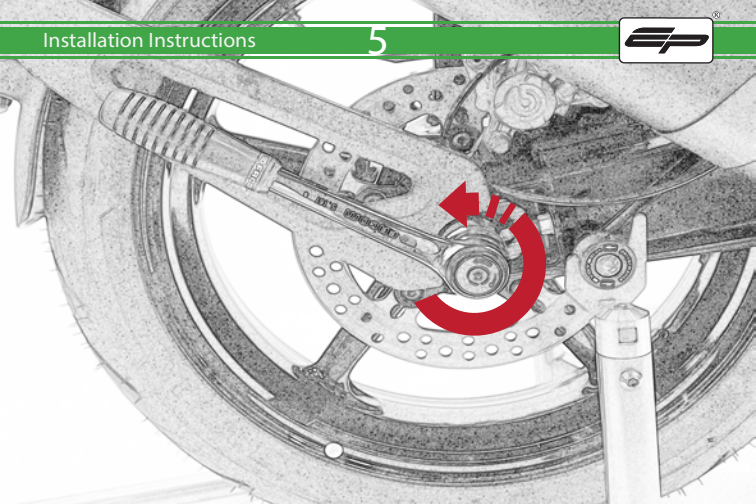

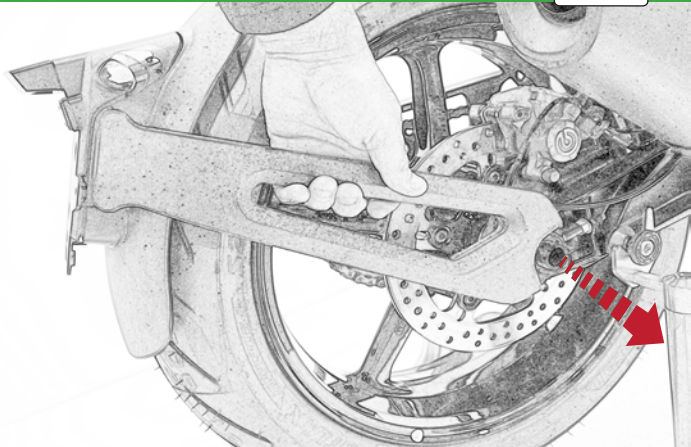

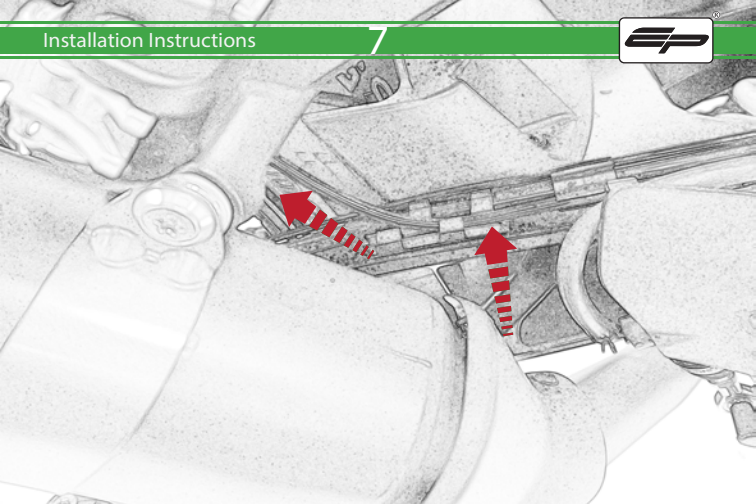

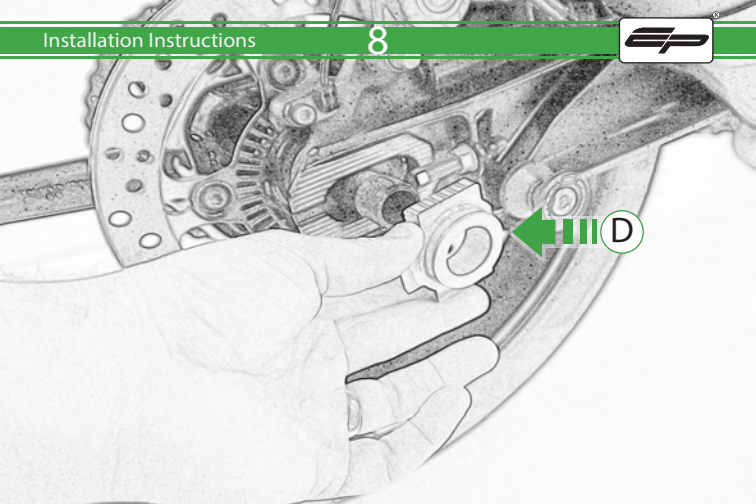

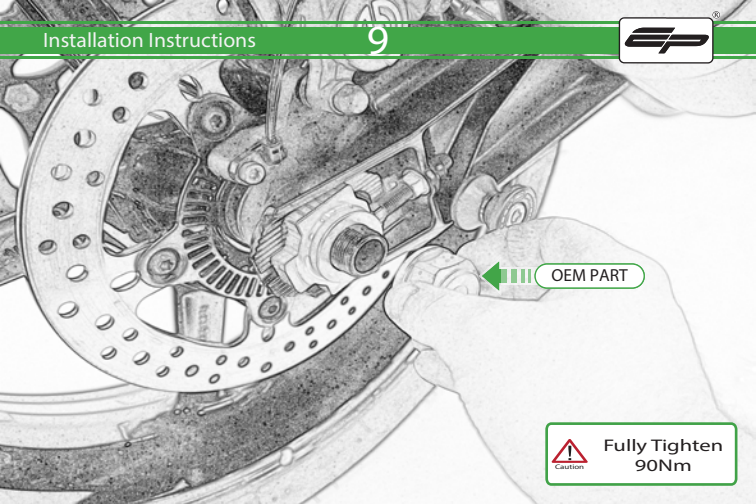

OEM PART



Fully Tighten
90Nm

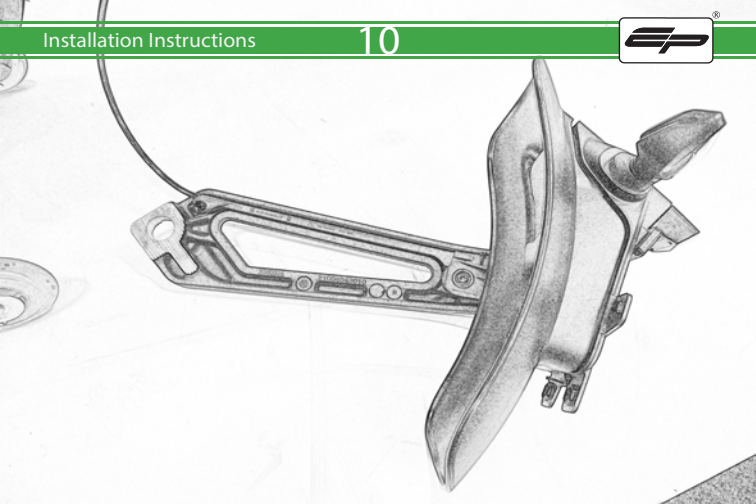

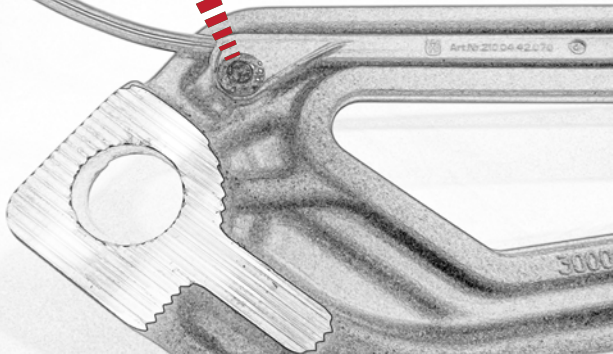

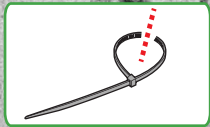
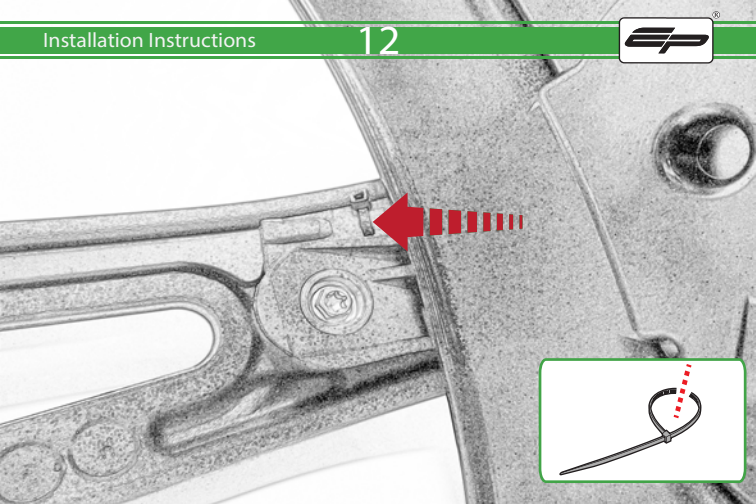

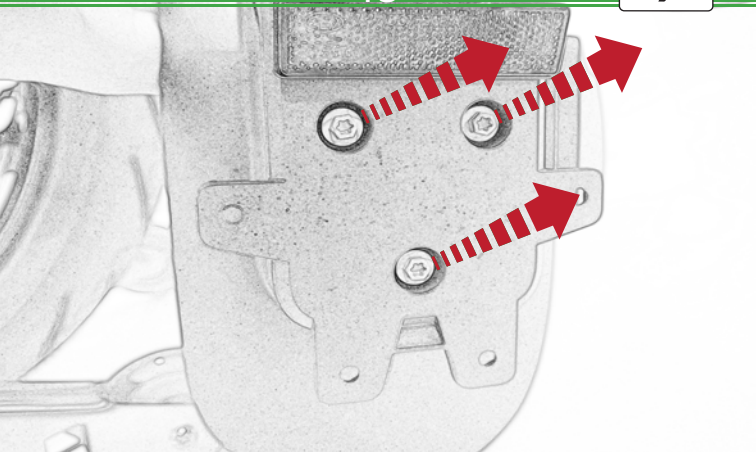

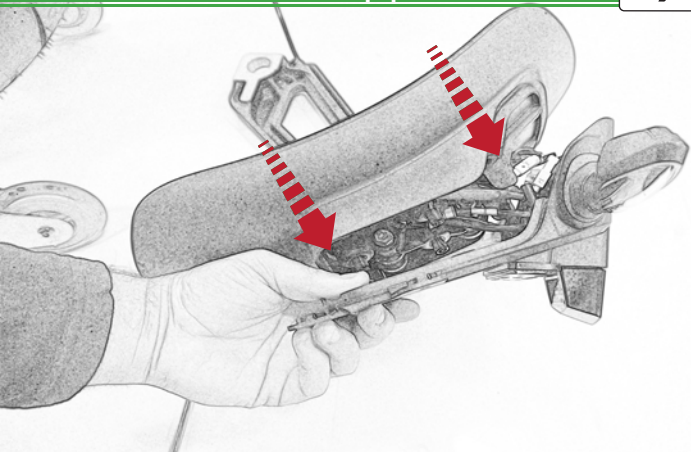

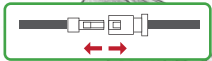
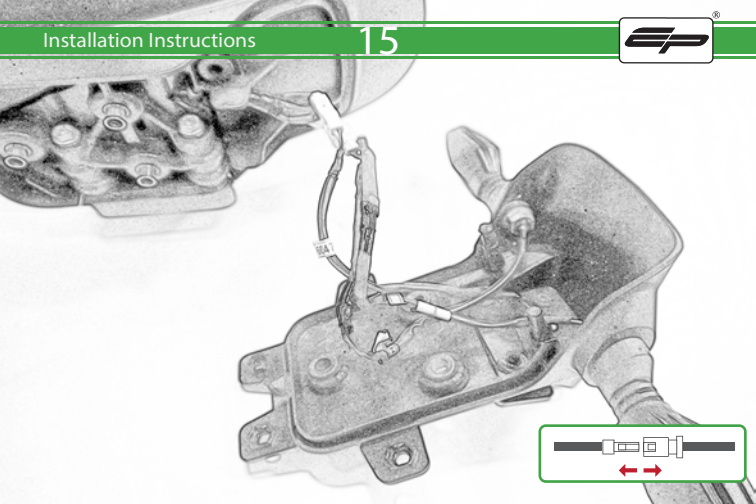

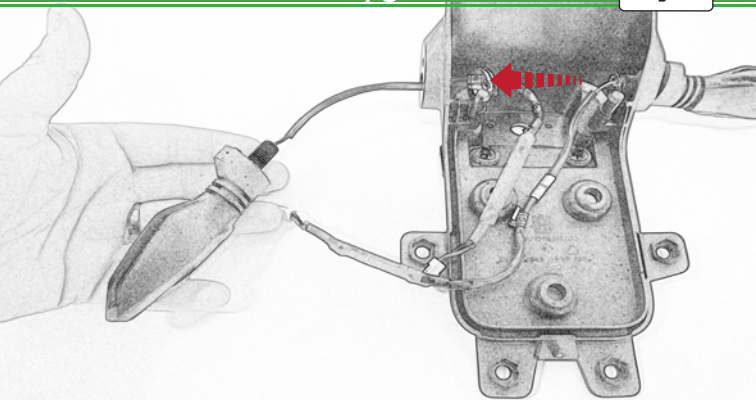

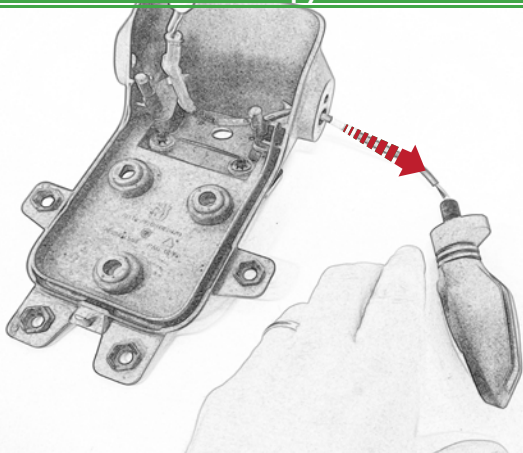

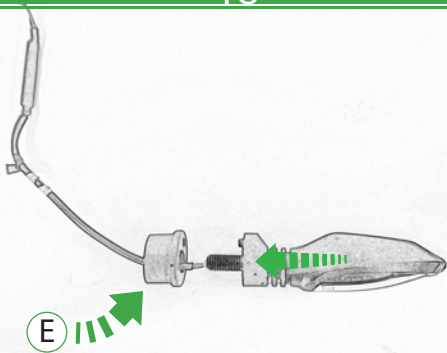

Repeat
Both Sides

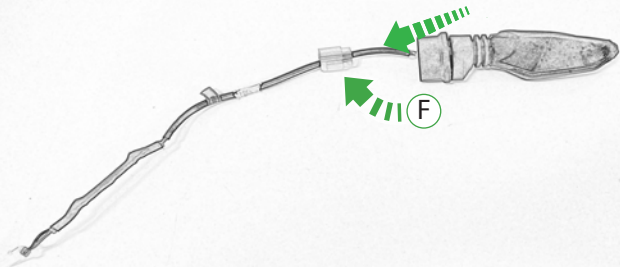

Repeat
Both Sides

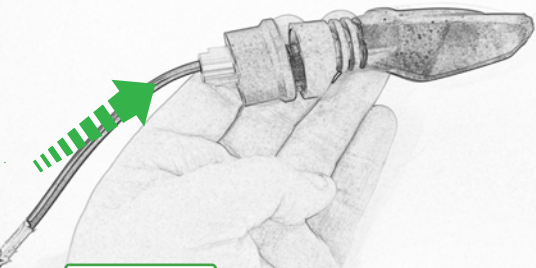

 **Fully Tighten**

Repeat Both Sides

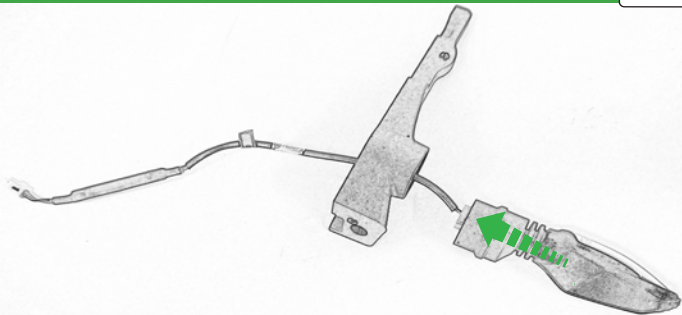

Repeat
Both Sides

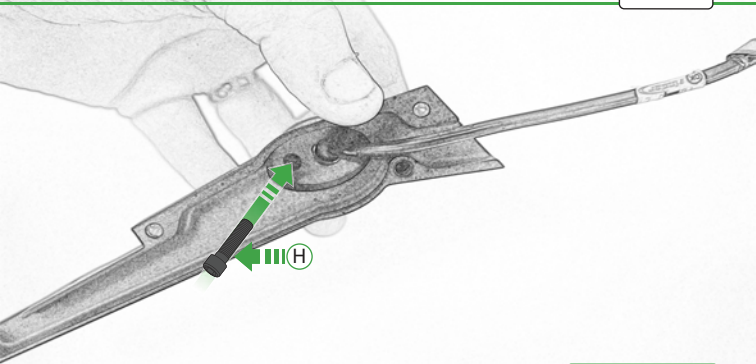

Repeat
Both Sides



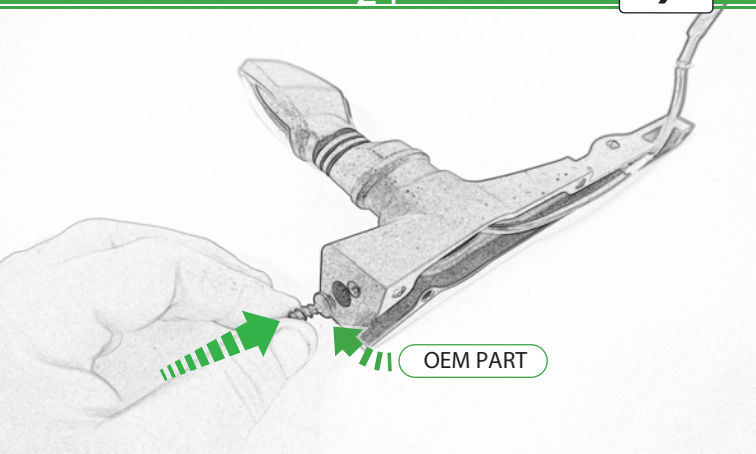

OEM PART

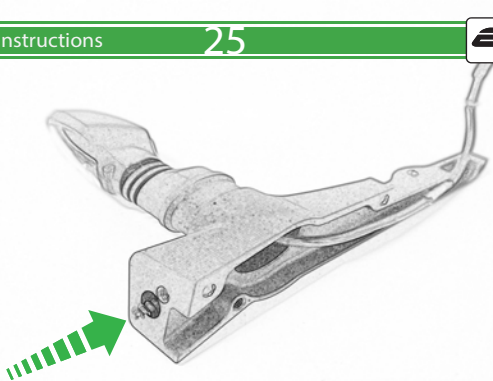

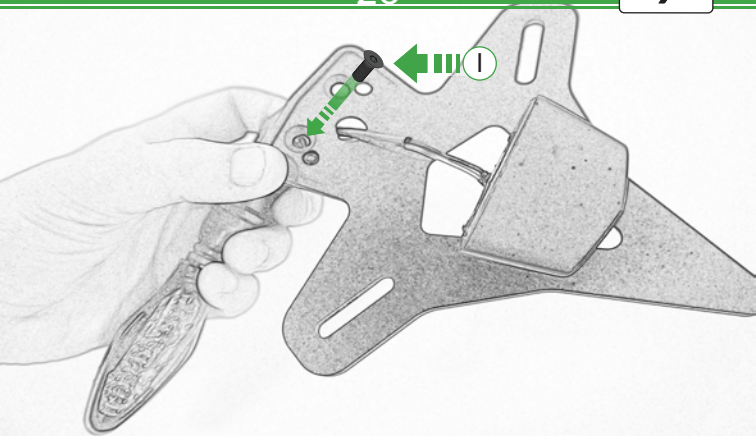

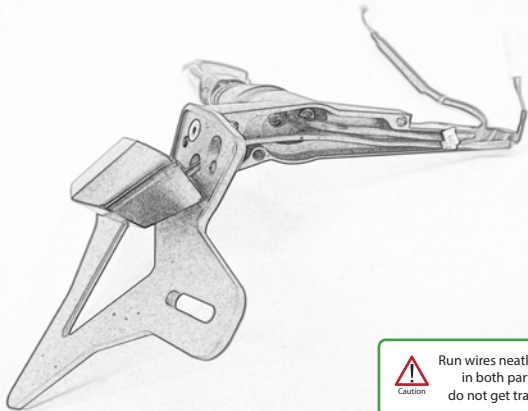

Caution

Run wires neatly down the channel
in both parts ensuring they
do not get trapped or squashed

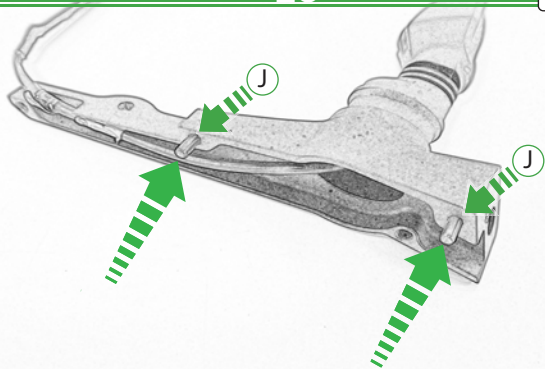

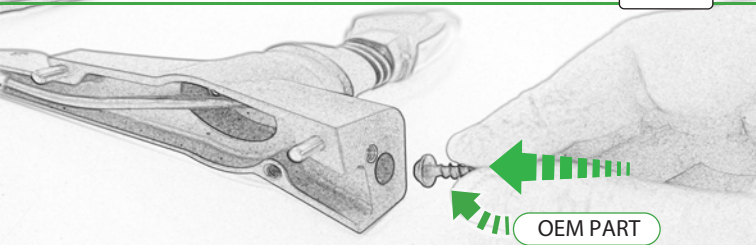

OEM PART

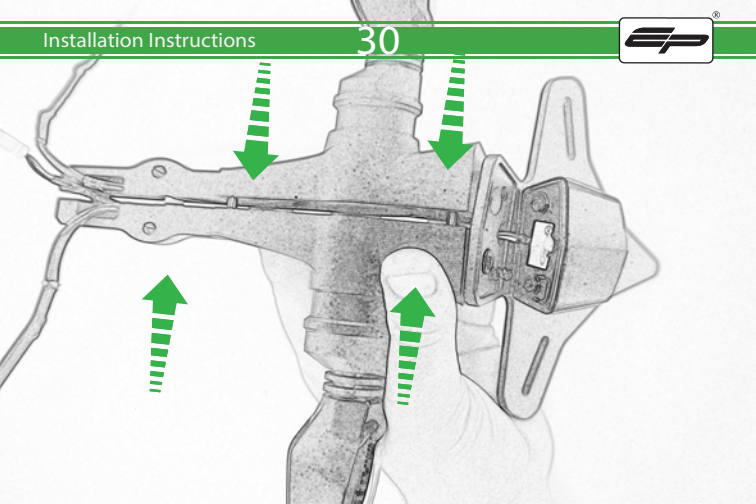

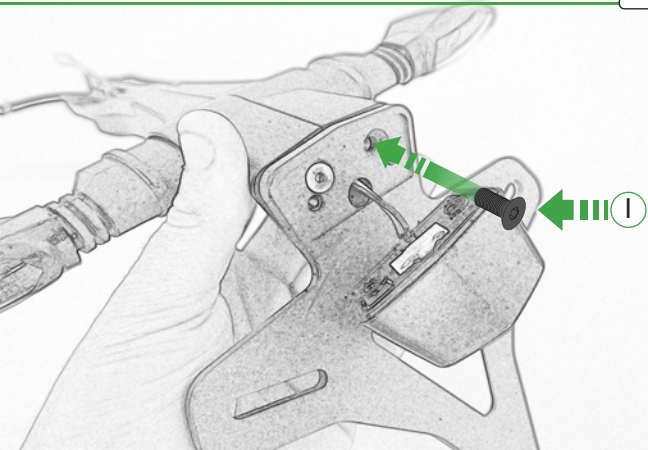

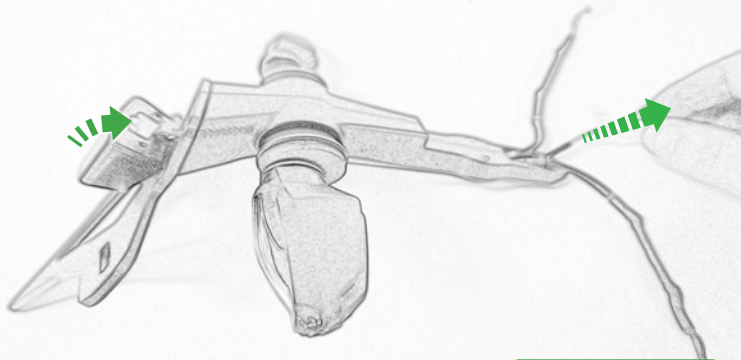

Caution

Pull Wire
Through Tail Tidy

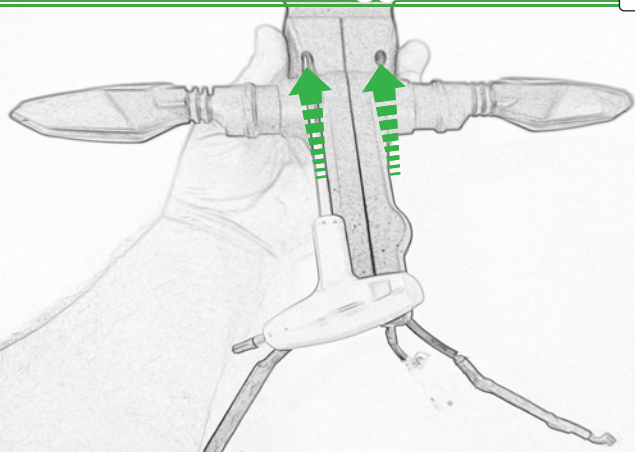

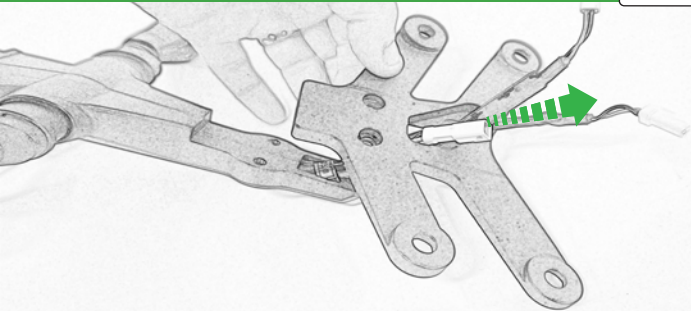

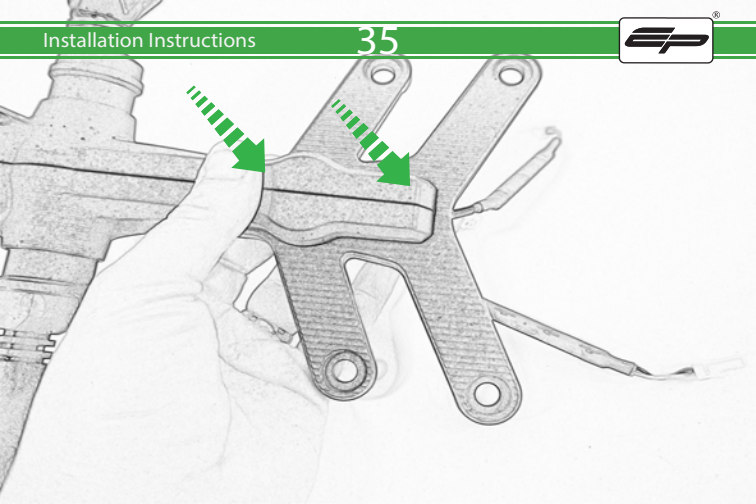

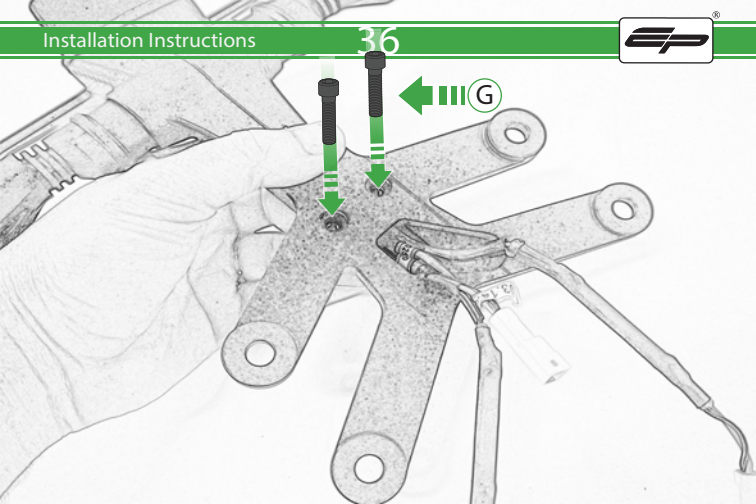



$\phi 22,5\text{mm}$



Use Target for
Drilling Hole

10750
06252600
104

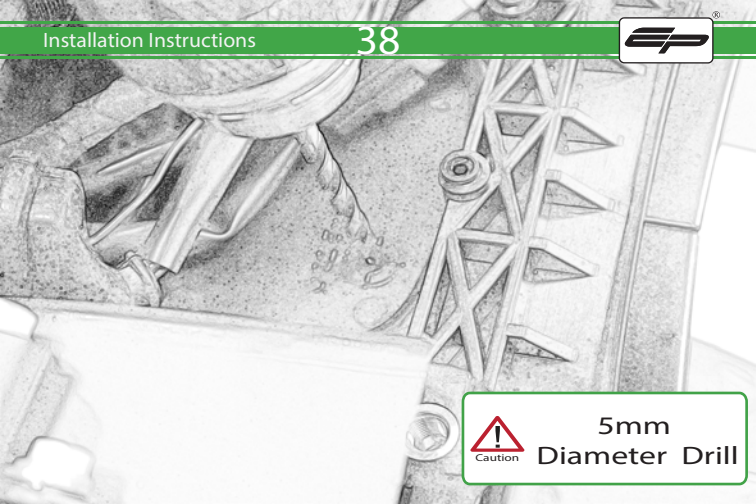

Caution

5mm
Diameter Drill

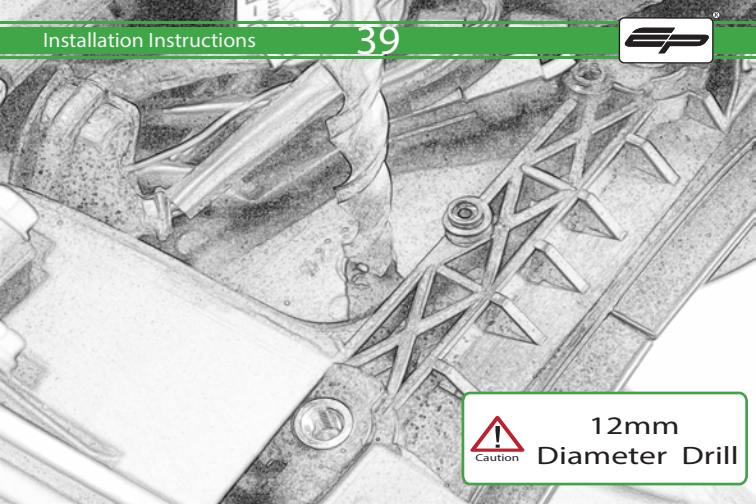

Caution

12mm
Diameter Drill

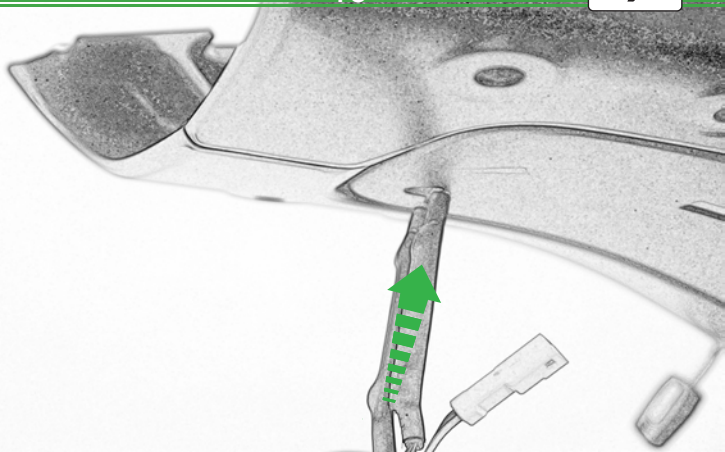

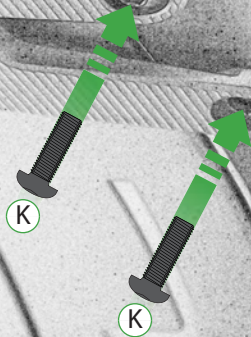

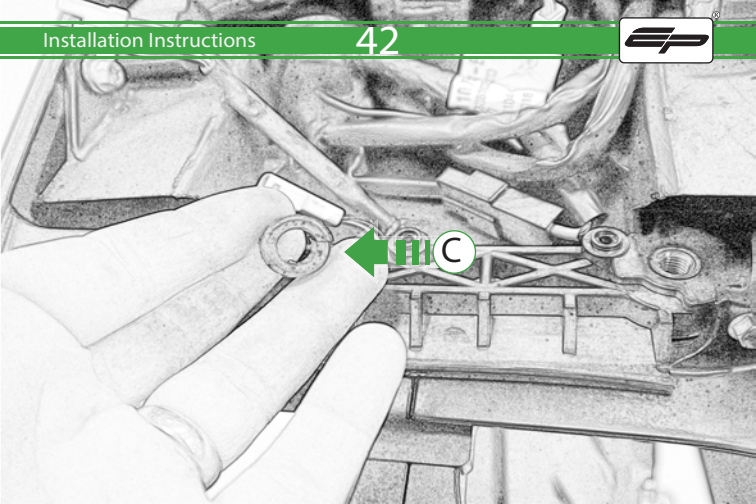

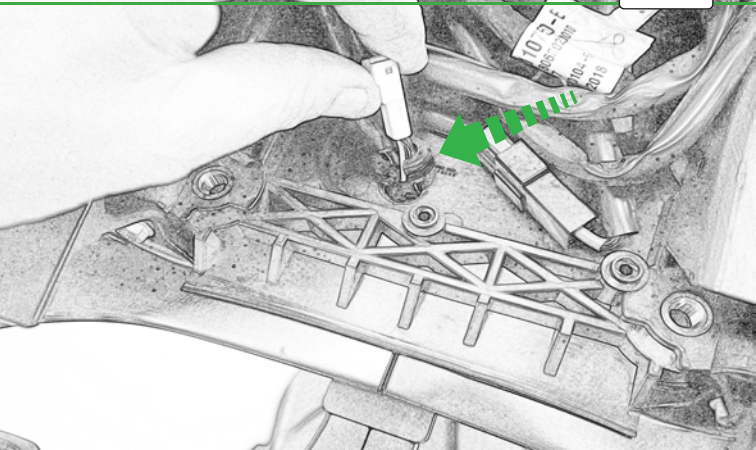

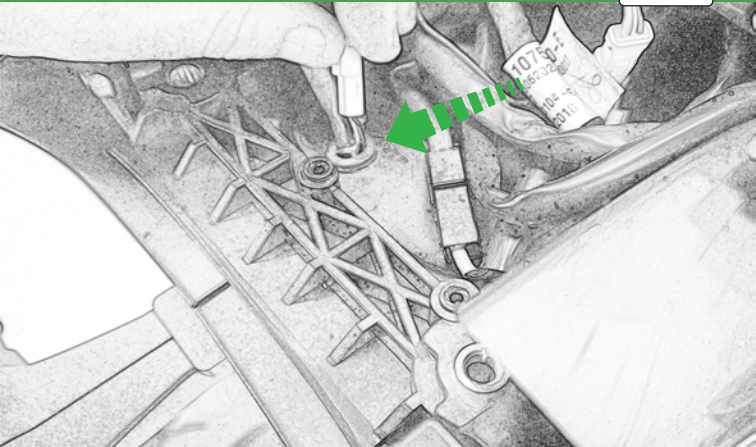

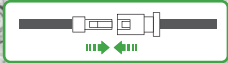
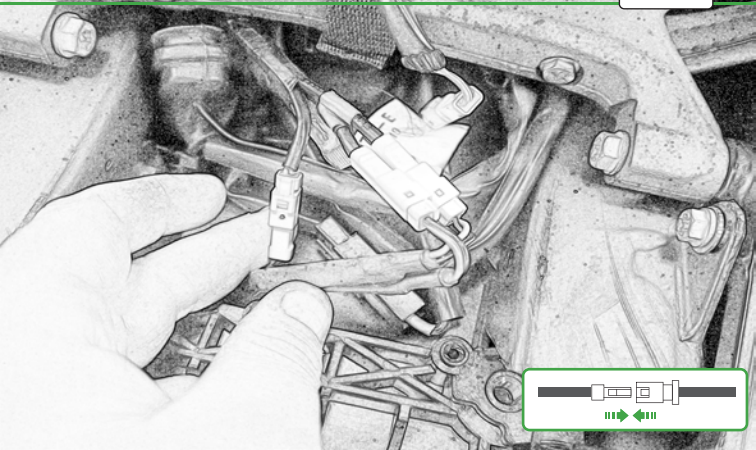



Reverse Stages

4 - 1

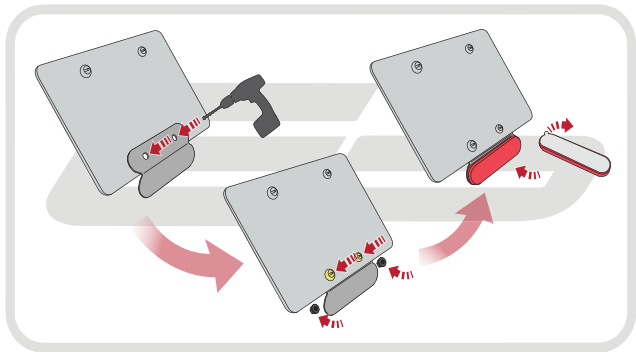

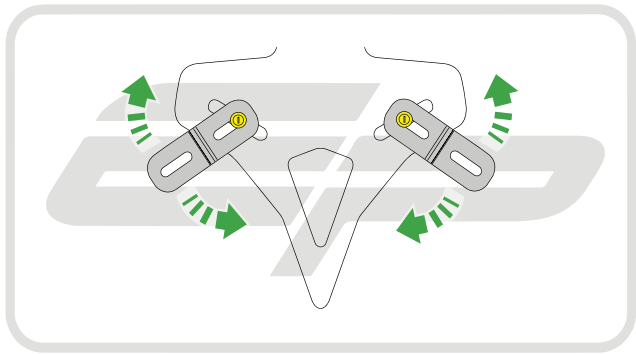



 **ESSENTIAL CHECKS** 

After installation of your tail tidy ensure that the licence plate does not contact the rear tyre when suspension is fully compressed.

Ensure all electrics including indicators, tail light, brake light and licence plate light lights are working correctly before riding the motorcycle.

It is recommended that periodic inspections are made to ensure that all fixings are fully tightend.



EVOTECH®
P E R F O R M A N C E

www.evotech-performance.com