



EVOTECH®
P E R F O R M A N C E

Ducati Diavel 1260
Tail Tidy

Installation Instructions

Kit Contents PRN014701

- | | |
|---------------------------------|----------------------------------|
| (A) 1 x Reflector Kit | (M) 1 x loom Connector |
| (B) 1 x Light Connector | (N) 2 x M6 Flange Nut |
| (C) 1 x Rear Light | (O) 2 x P-clip Number 3 |
| (D) 1 x Light Housing | (P) 2 x M4 x 6 Button Head Bolt |
| (E) 1 x Main Arm | (Q) 2 x Rubber Pads |
| (F) 1 x Number Plate Bracket | (R) 2 x M6 x 20 Button Head Bolt |
| (G) 1 x Sub Indicator Bracket | (S) 4 x M6 Washers |
| (H) 1 x Main Cover Bracket | (T) 4 x M8 x 30 Button Head Bolt |
| (I) 1 x Plastic Cover Plate L/H | (U) 4 x M6 x 25 Button Head Bolt |
| (J) 1 x Plastic Cover Plate R/H | (V) 9 x M5 x 10 Button Head Bolt |
| (K) 1 x Inner Frame Bracket R/H | |
| (L) 1 x Inner Frame Bracket L/H | |

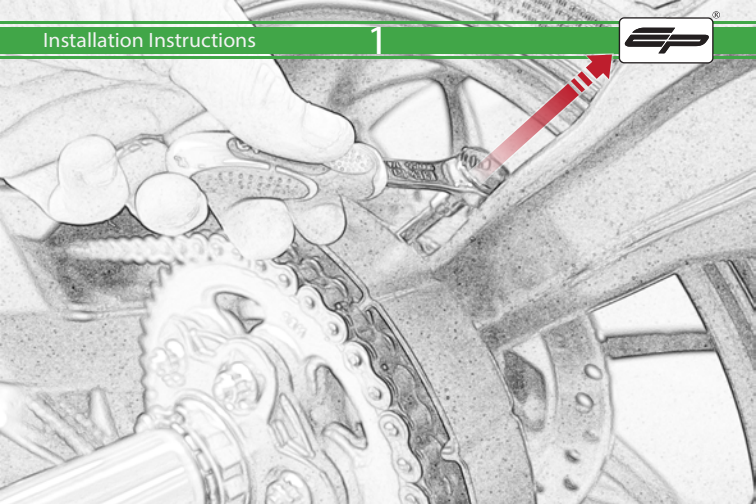

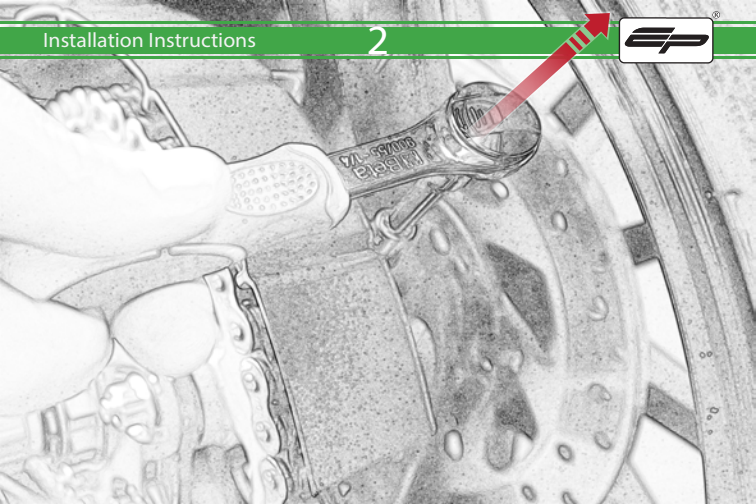

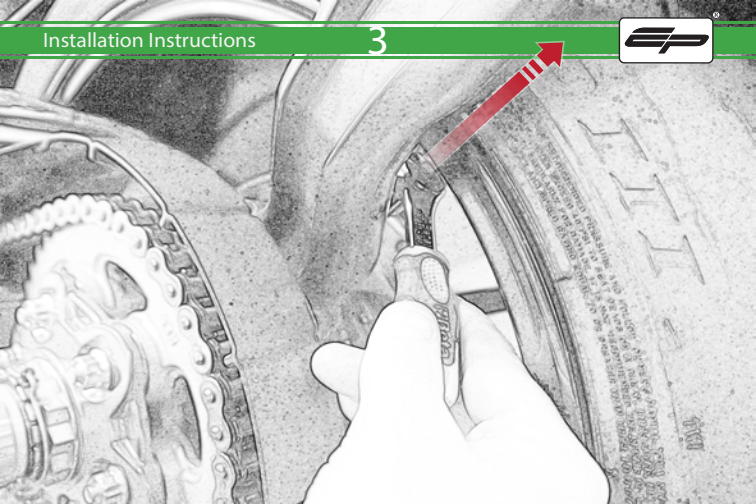

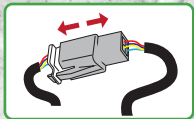
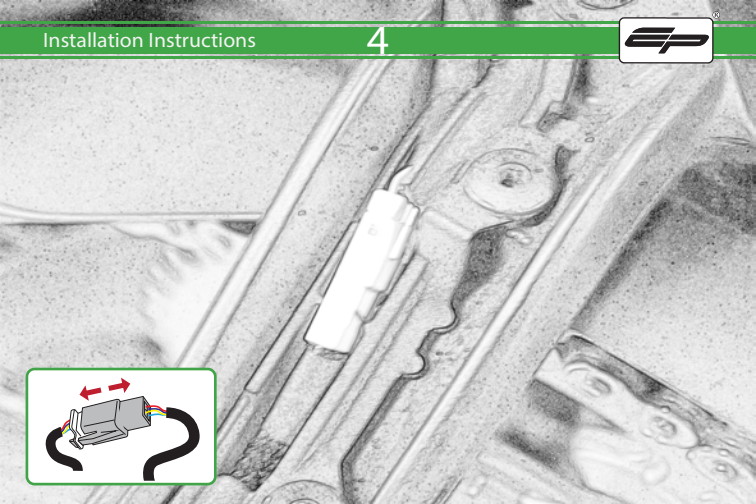

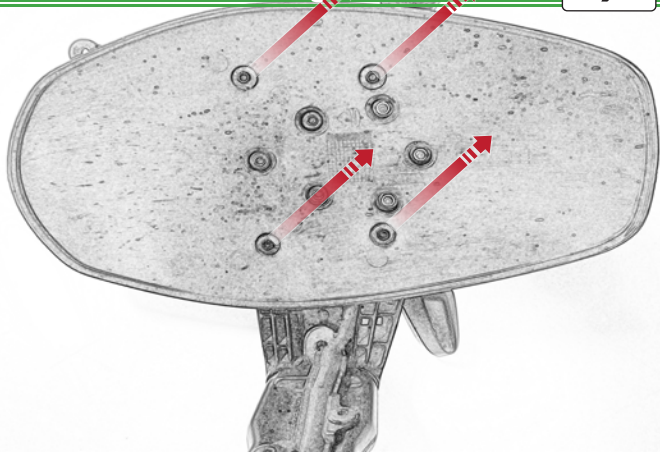

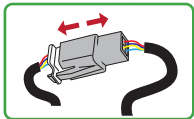
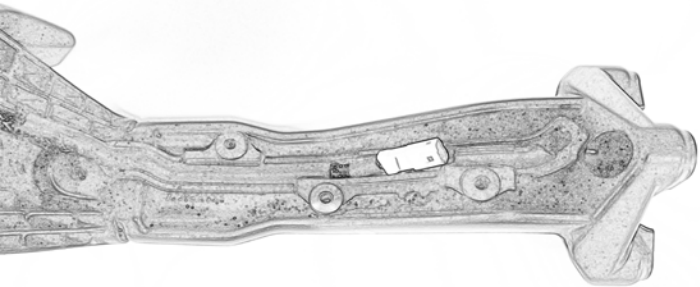

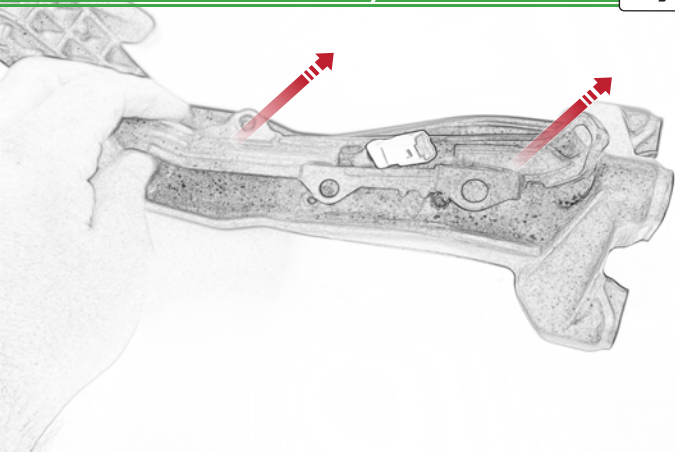

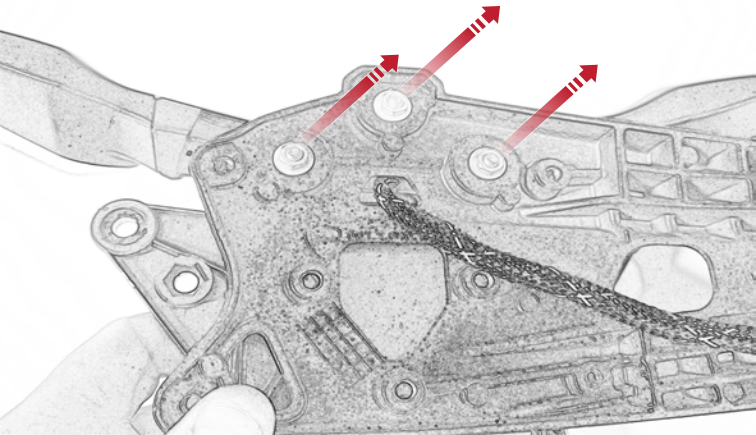

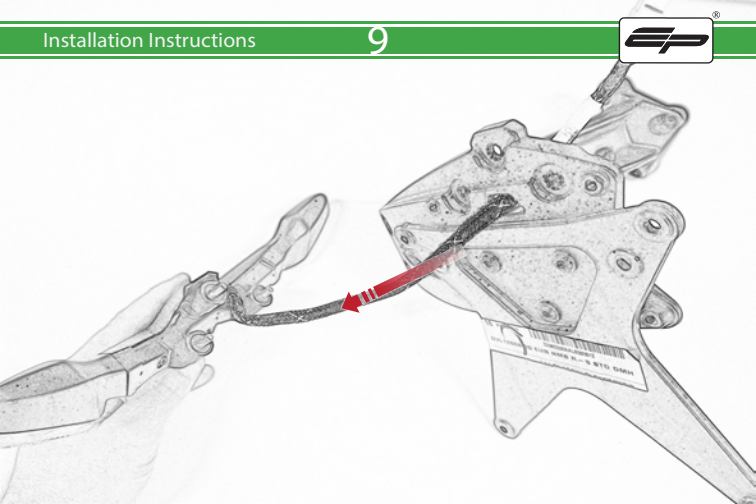

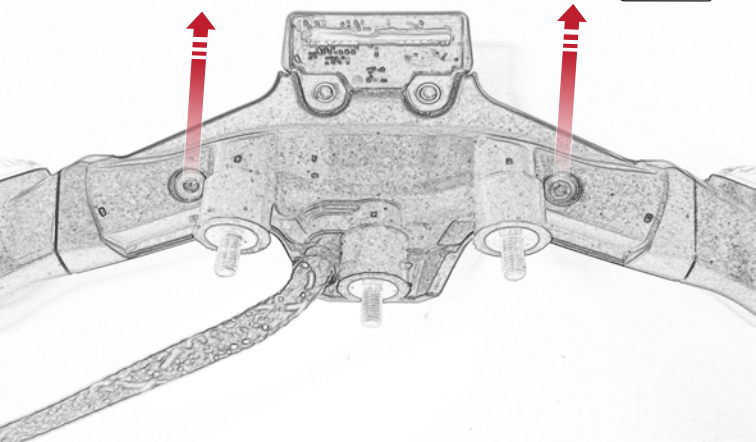

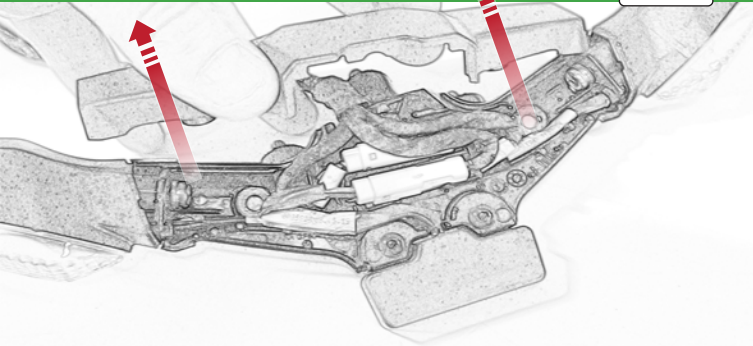

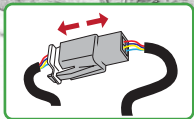
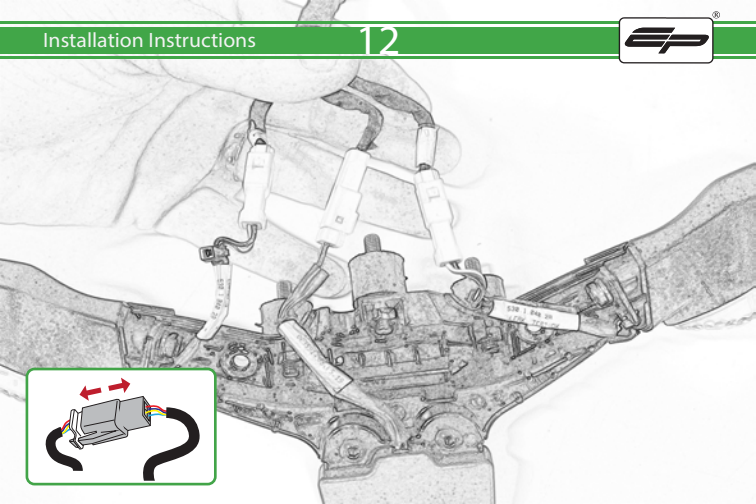

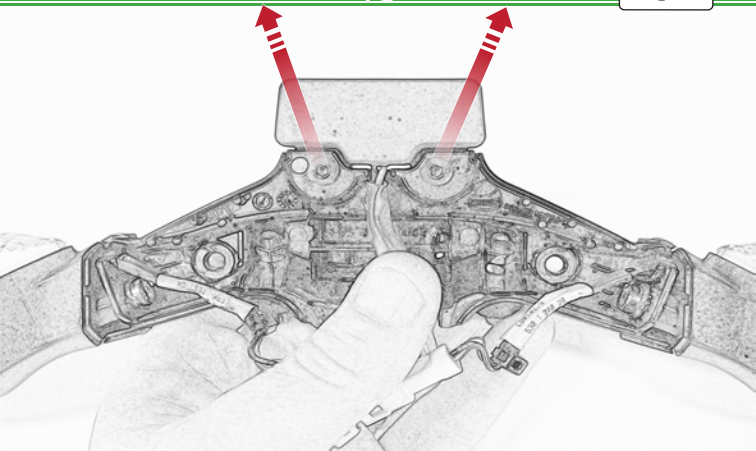

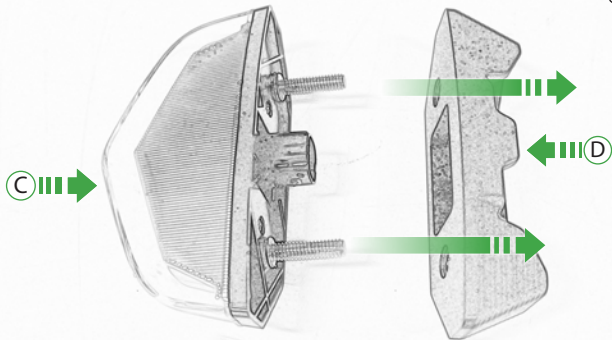

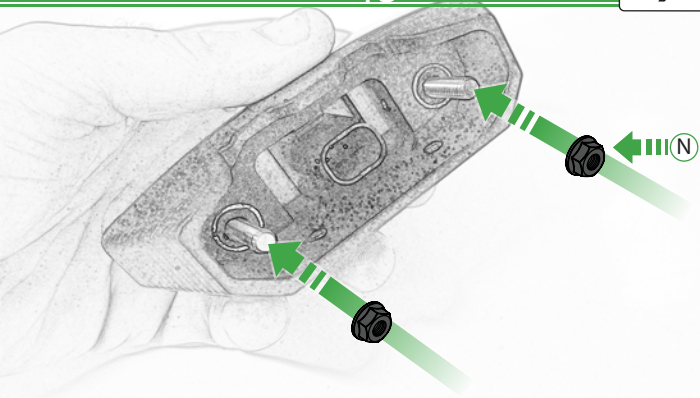

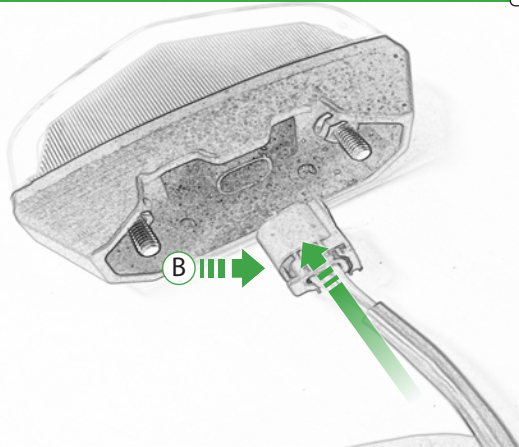



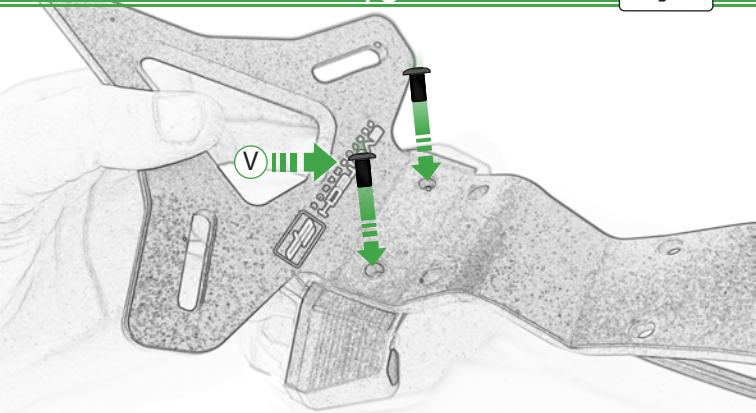

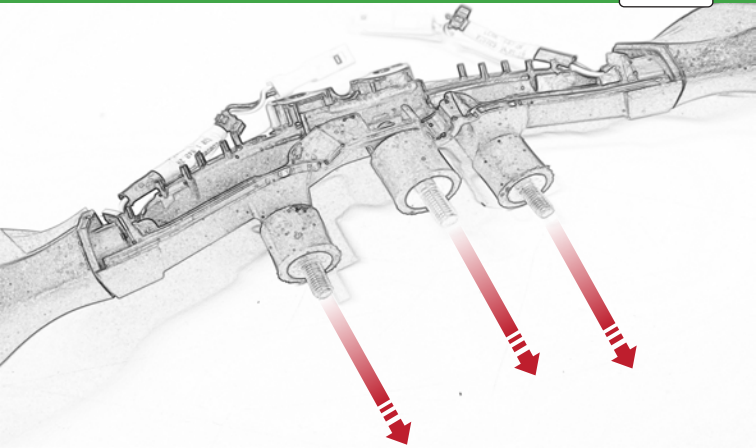

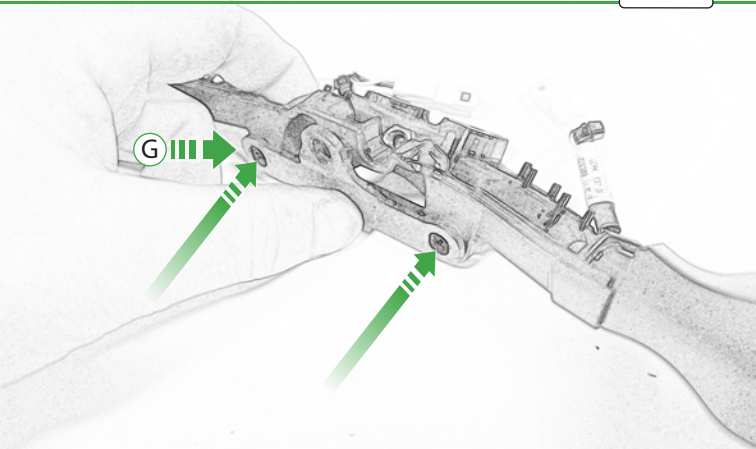

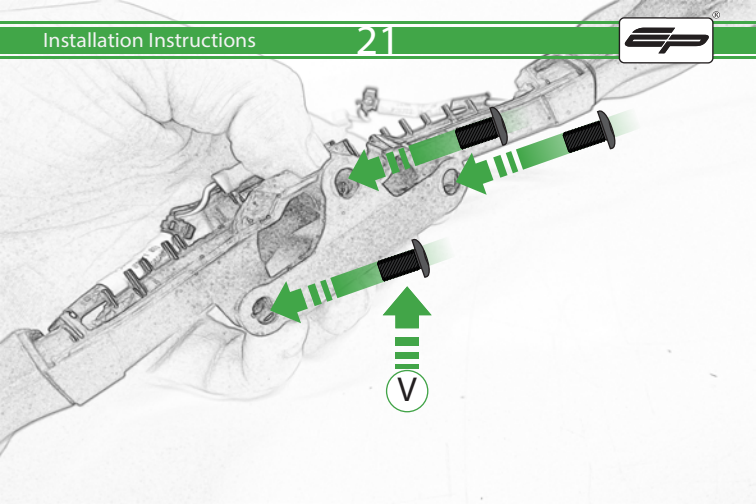

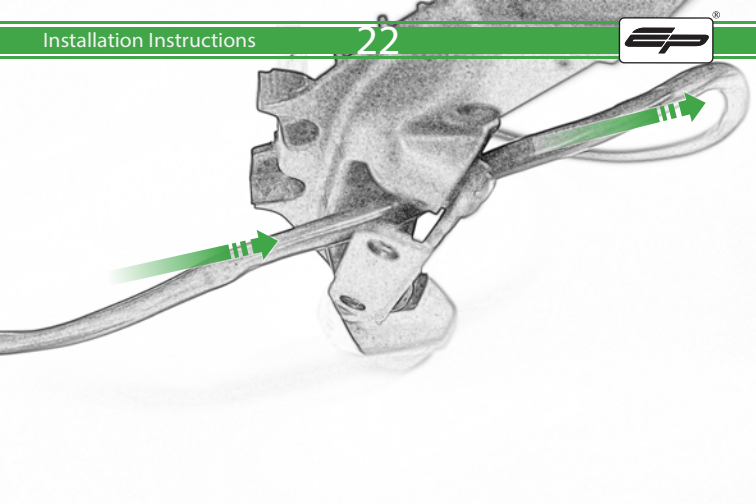

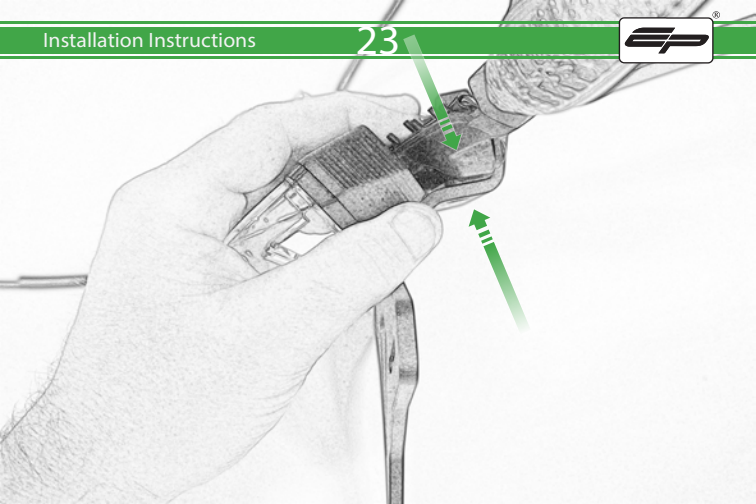

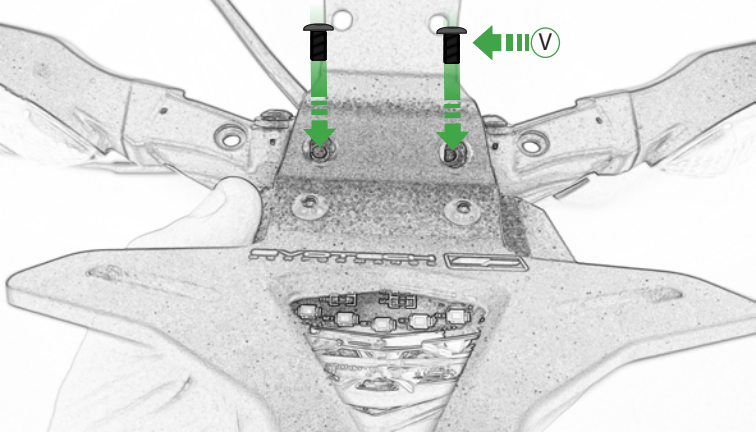

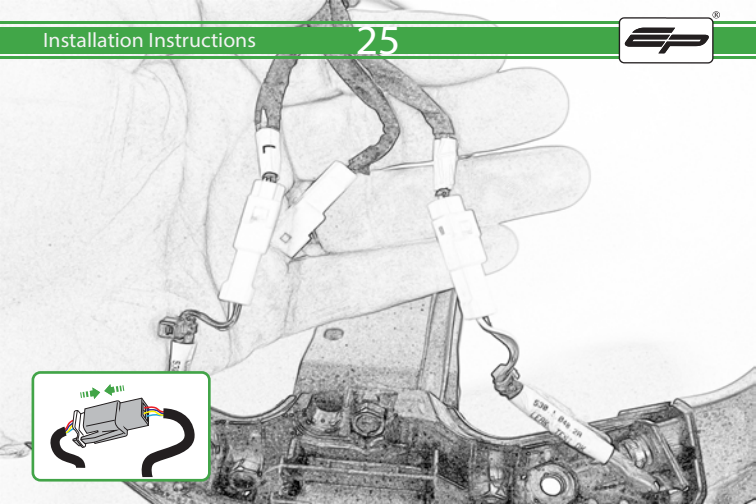
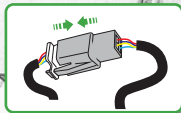

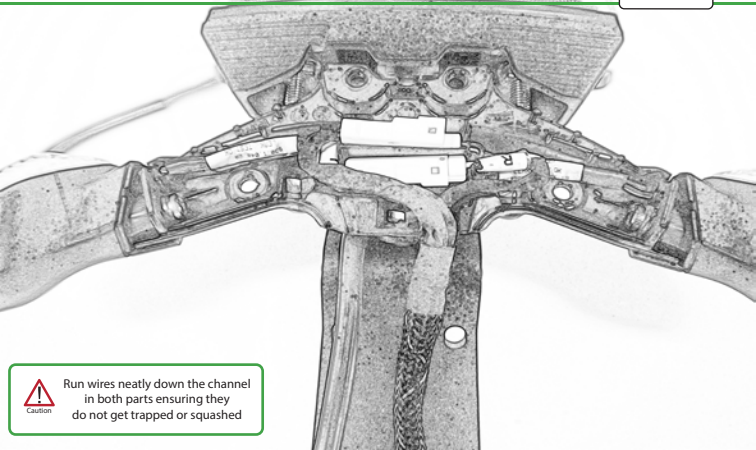

Caution

Run wires neatly down the channel in both parts ensuring they do not get trapped or squashed

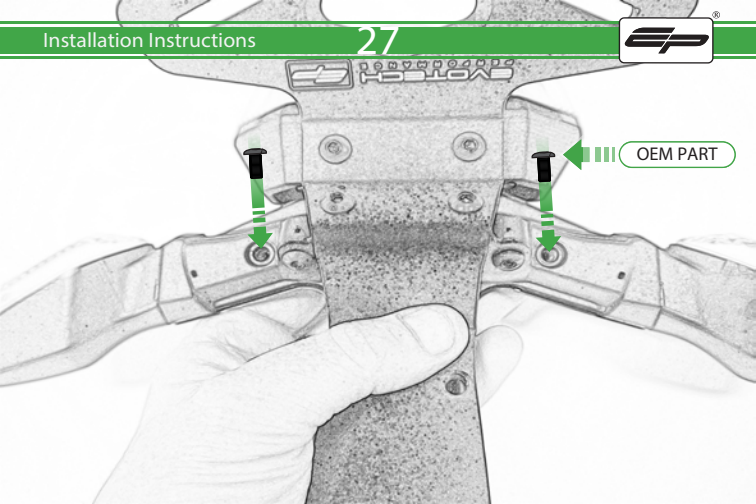

OEM PART

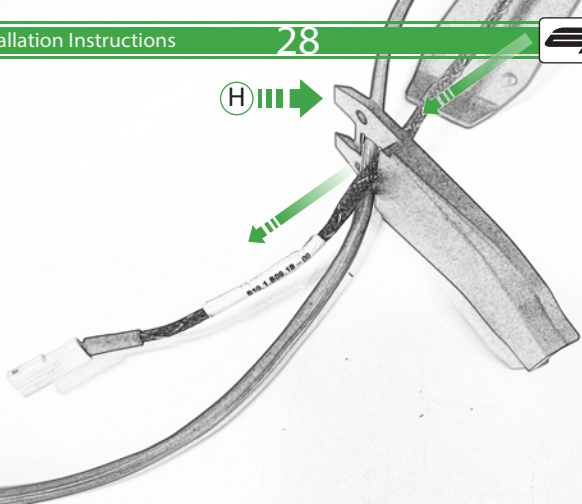

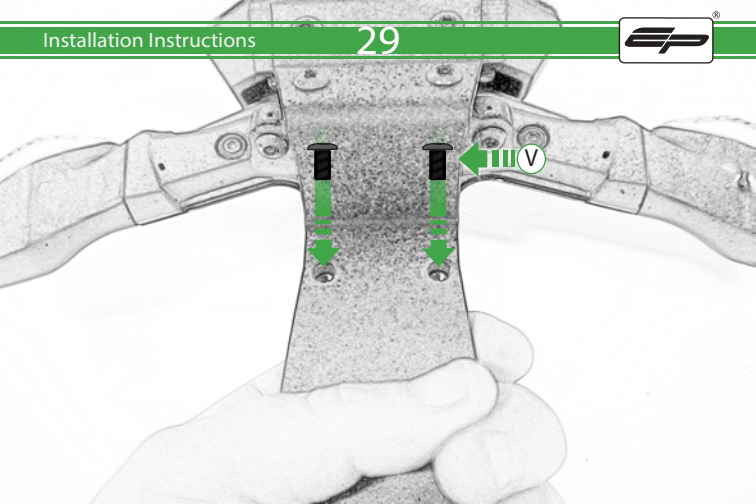

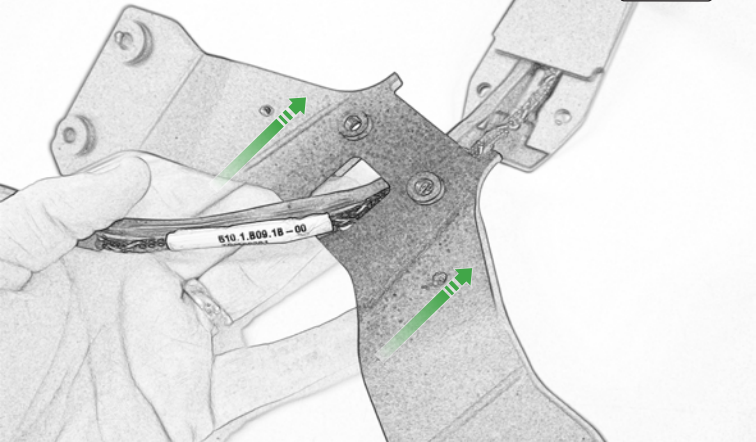

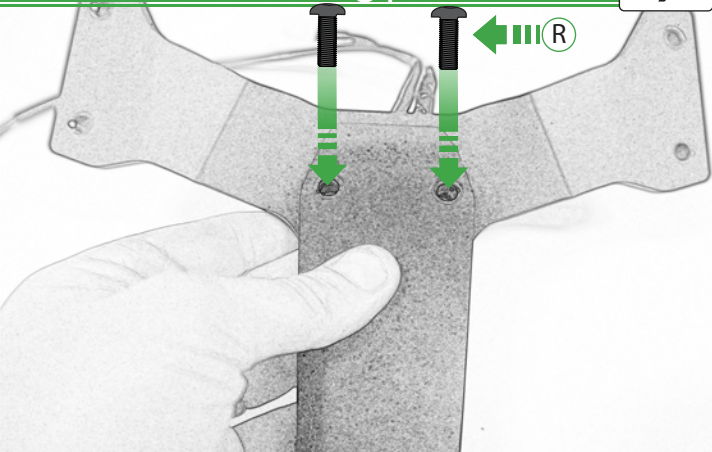

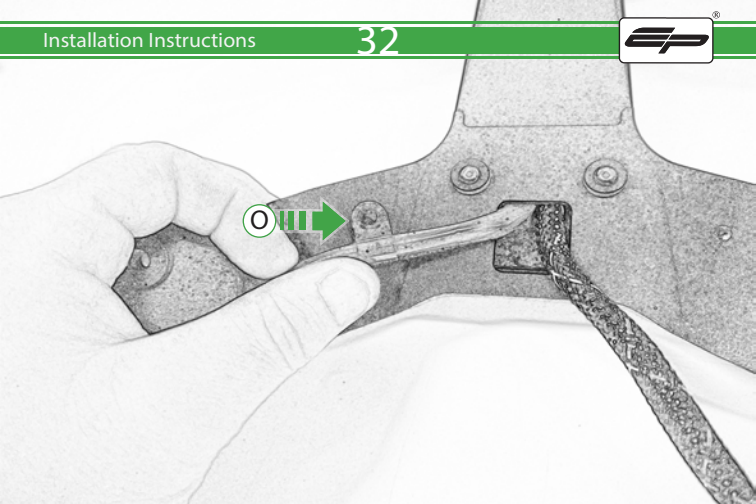

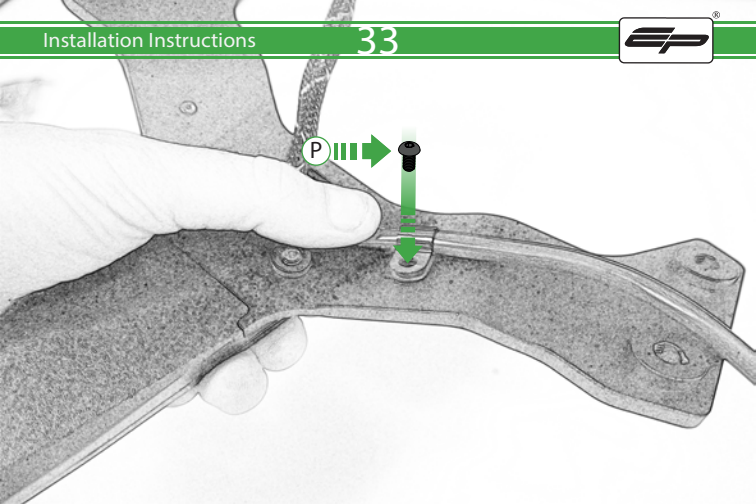

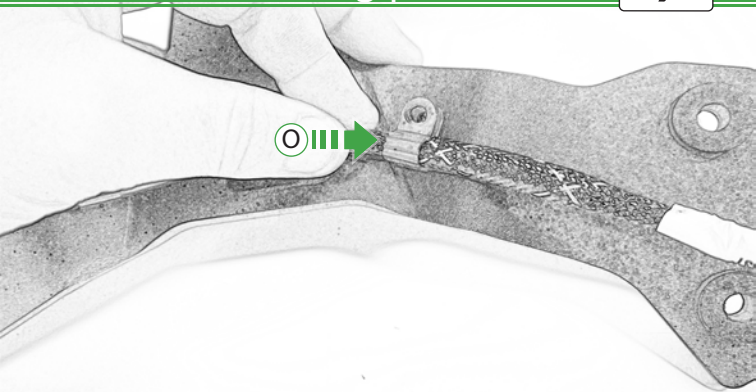

35
P III

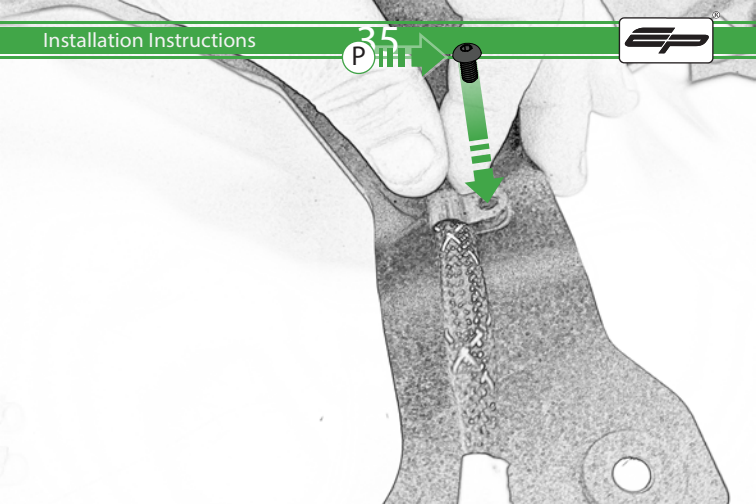

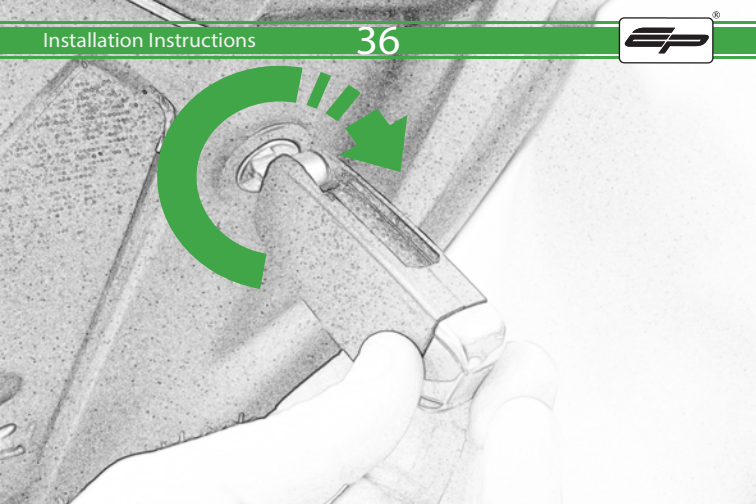

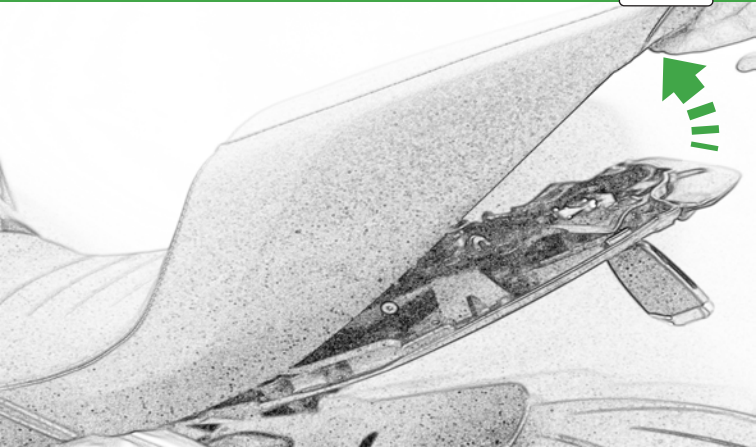

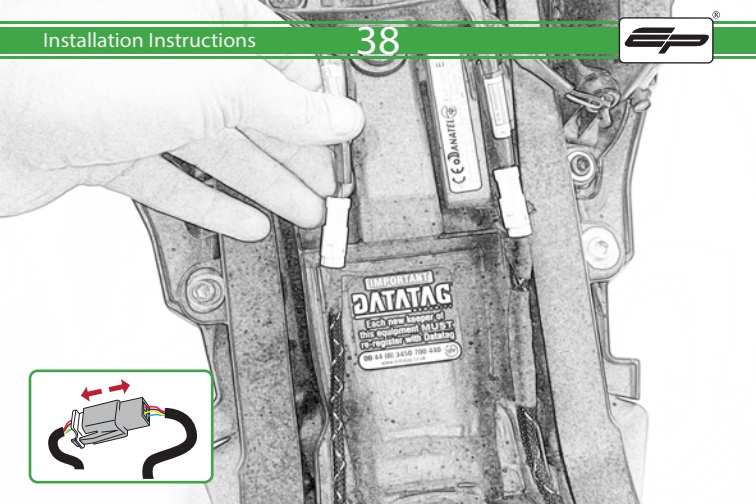
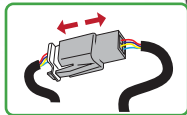

IMPORTANT DATATAG
Each new keeper of
this equipment MUST
re-register with Datatag
00 44 181 3450 700 440
www.datatag.co.uk

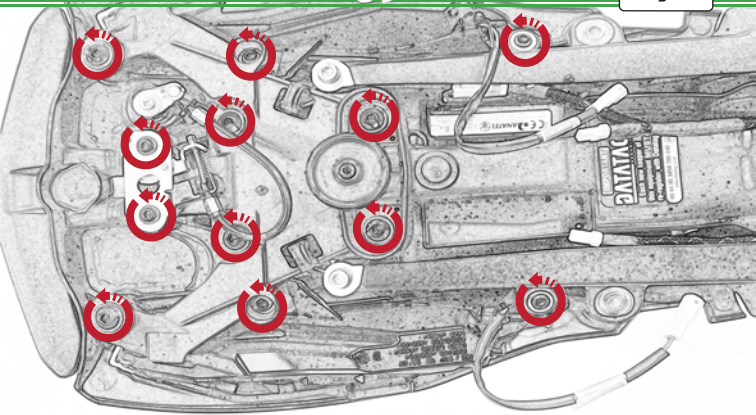



Repeat
Both Sides

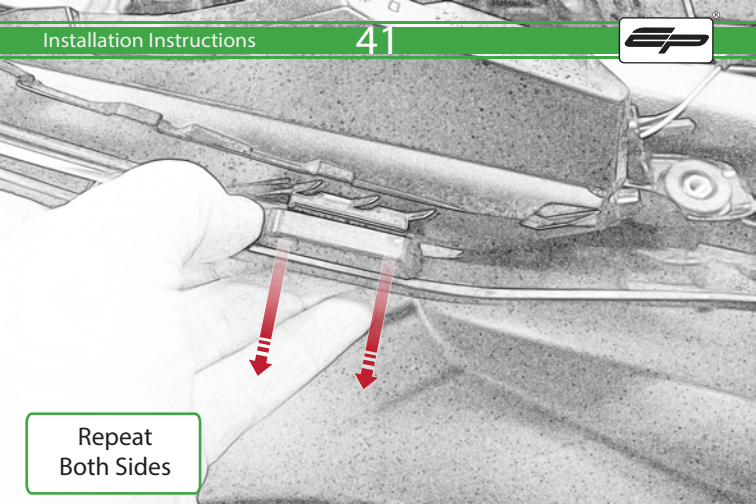

Repeat
Both Sides

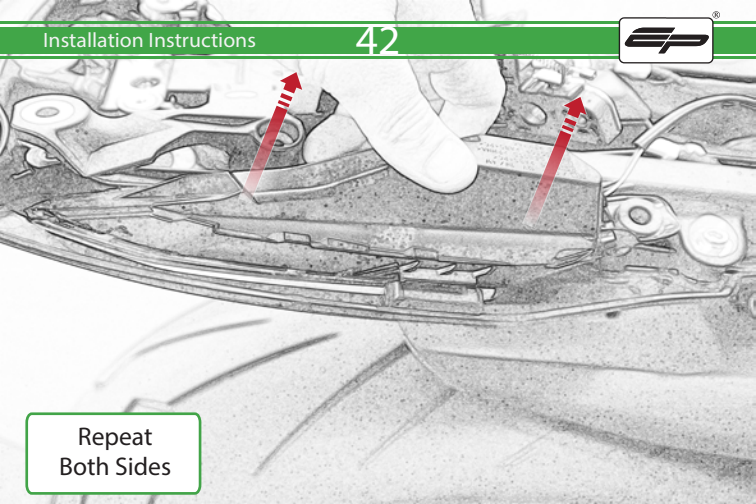

Repeat
Both Sides

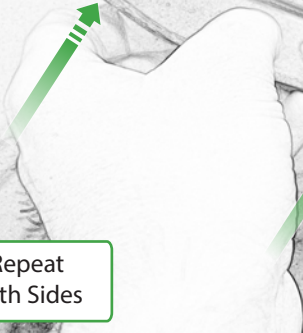

Repeat
Both Sides

A close-up photograph of a hand pointing to a specific component on a metal chassis. Two green arrows with dashed lines point from the hand towards the component. The component is a small, rectangular metal block mounted on a metal plate. The background shows various other parts of the chassis, including screws and wiring.

Repeat
Both Sides

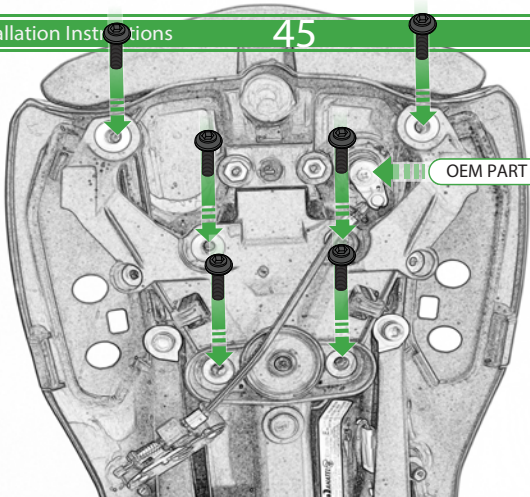

OEM PART



OEM PART

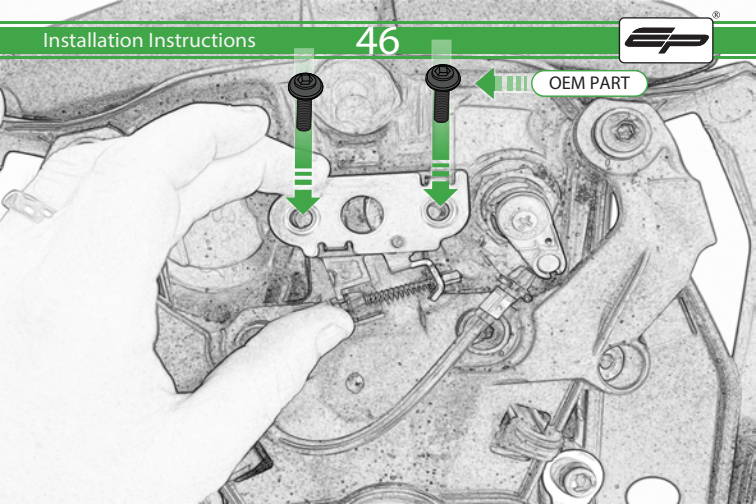

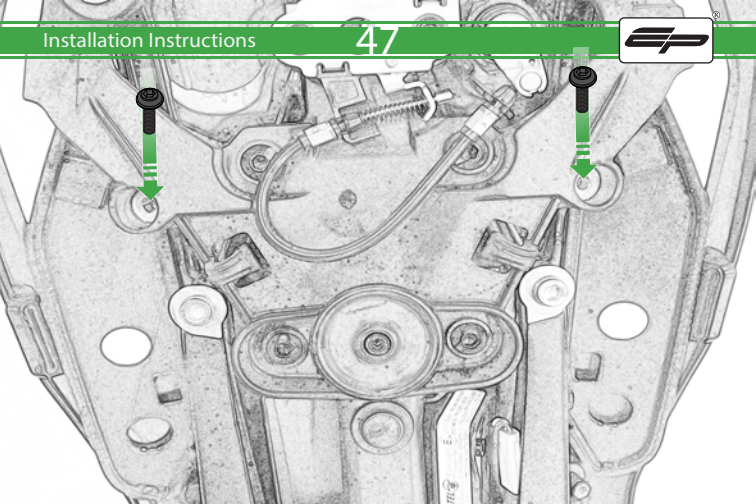

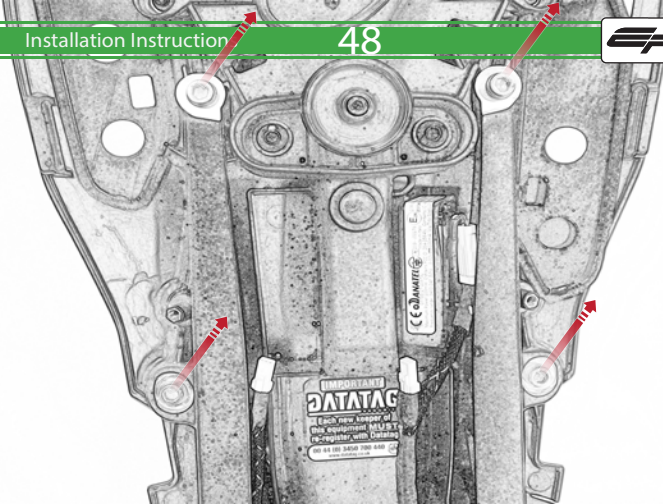

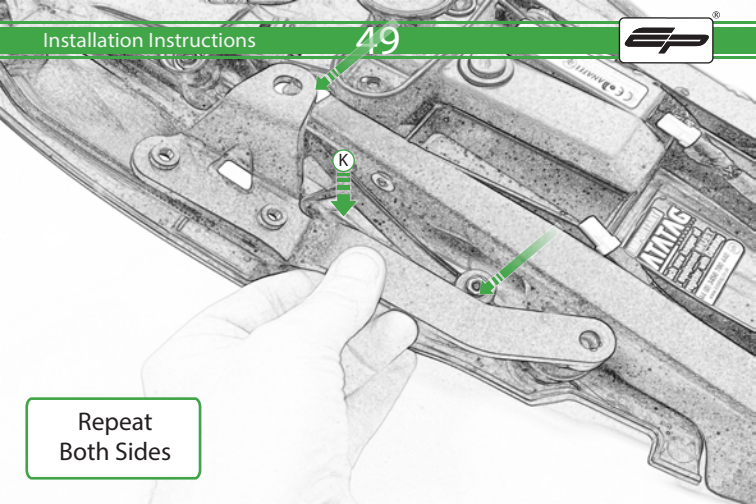

Repeat
Both Sides

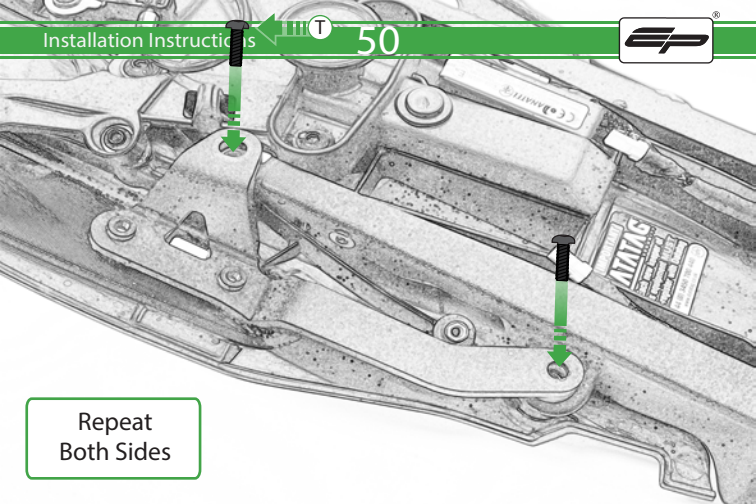

Repeat
Both Sides

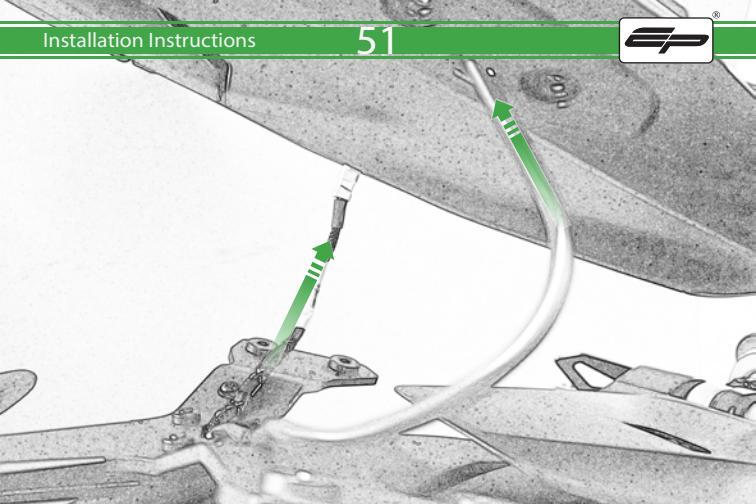

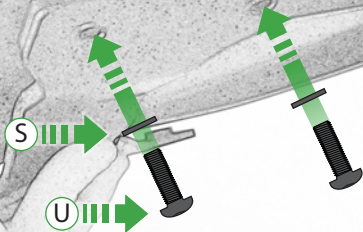

Do Not Fully
Tighten

Repeat
Both Sides

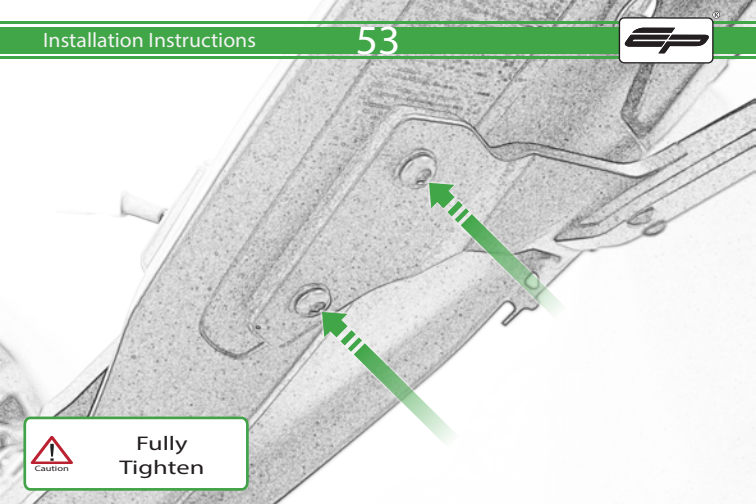

Caution

Fully
Tighten

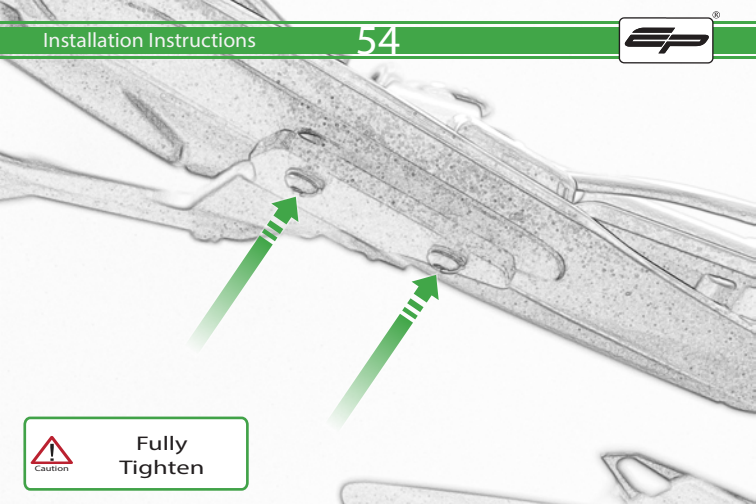

Caution

Fully
Tighten

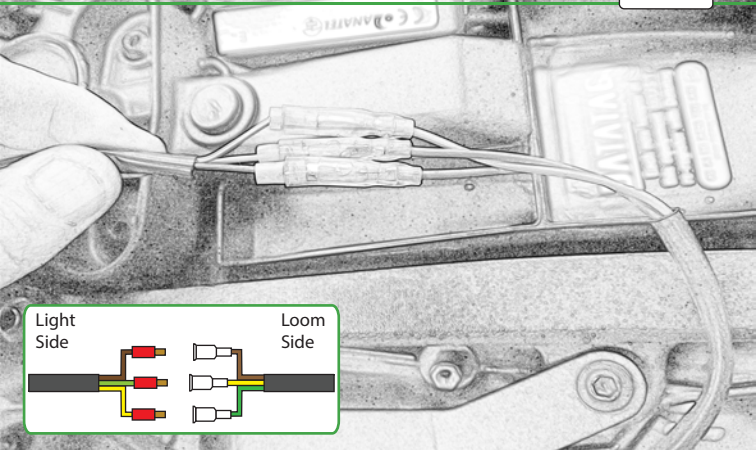

Light
Side

Loom
Side

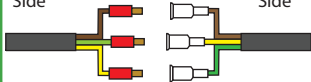

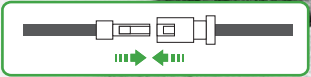
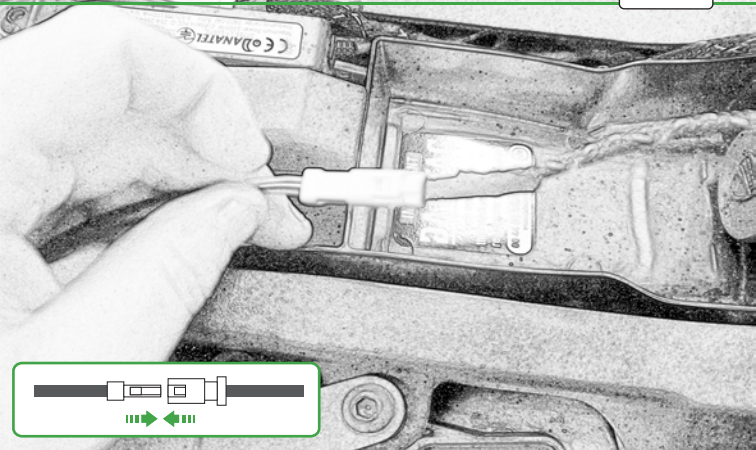

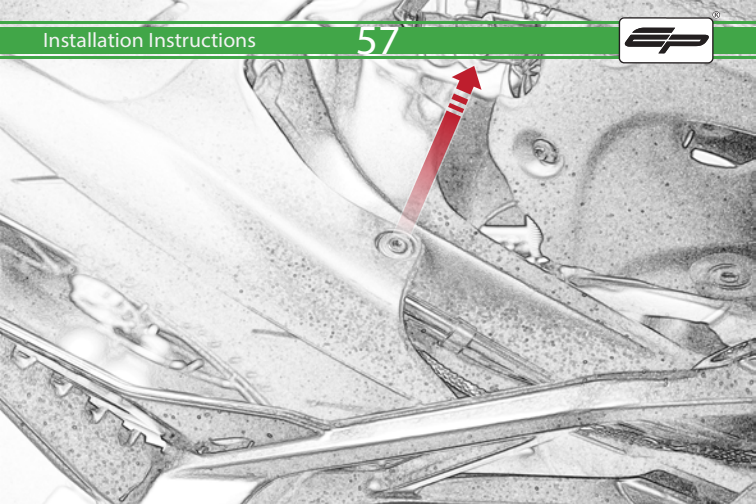

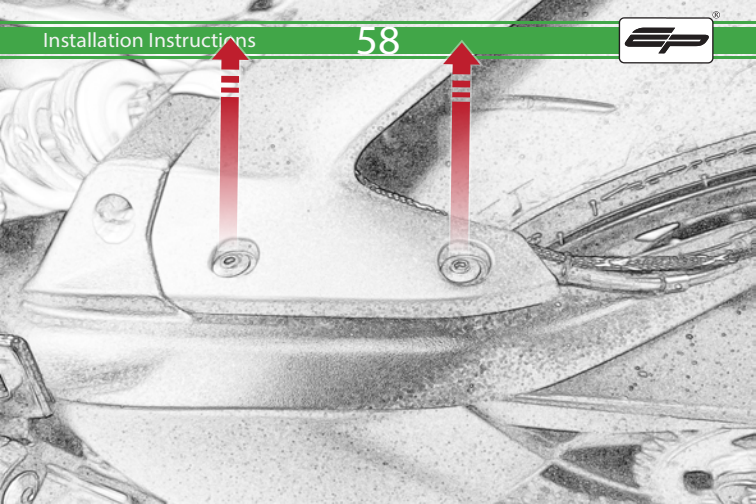

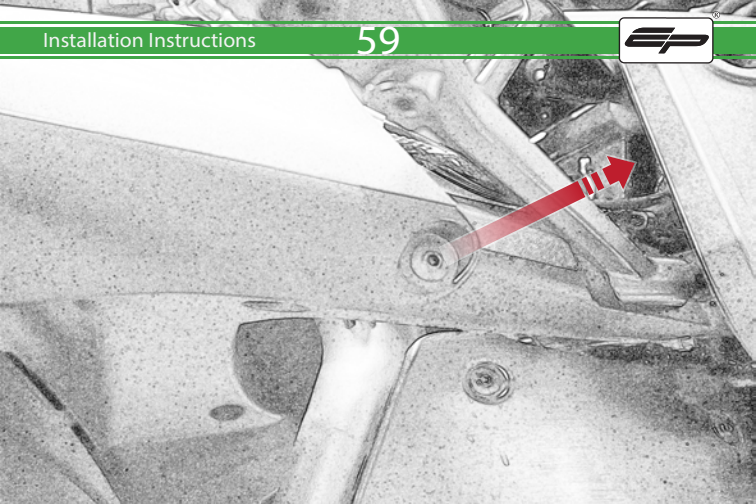

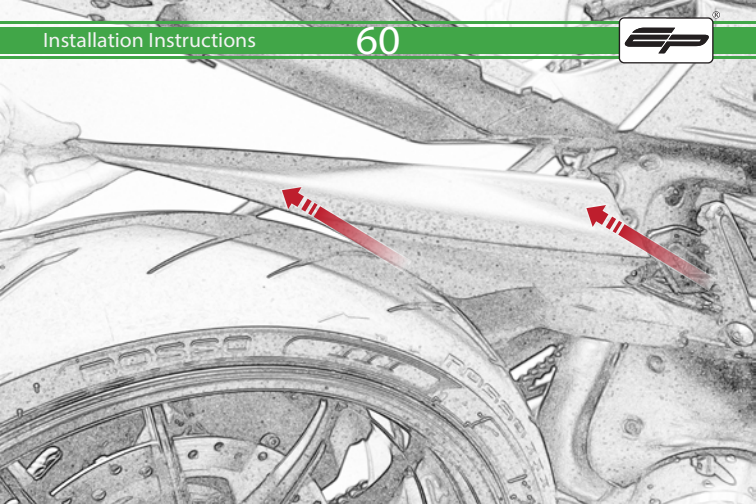

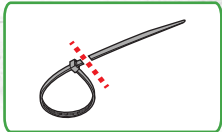

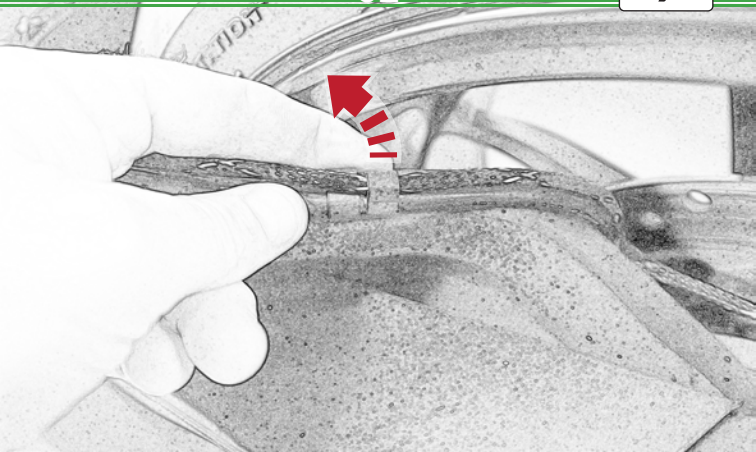

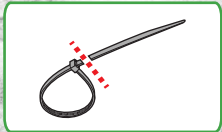
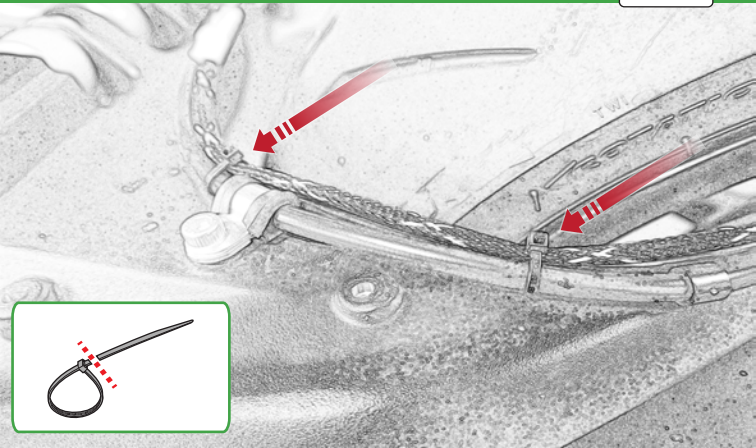

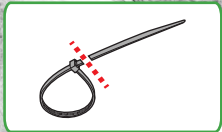
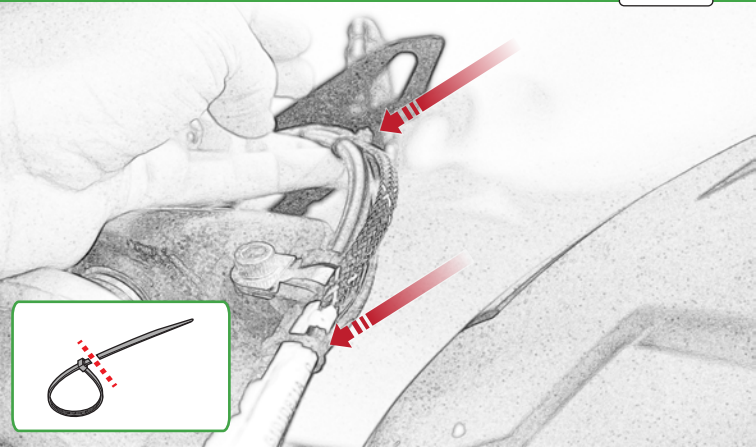



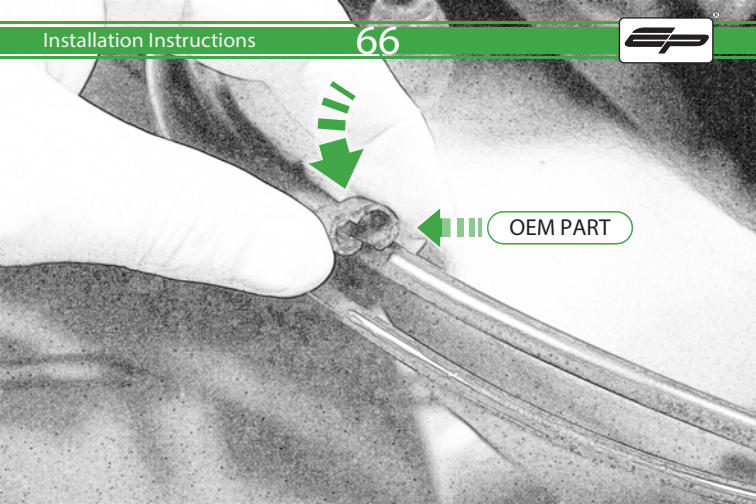

OEM PART

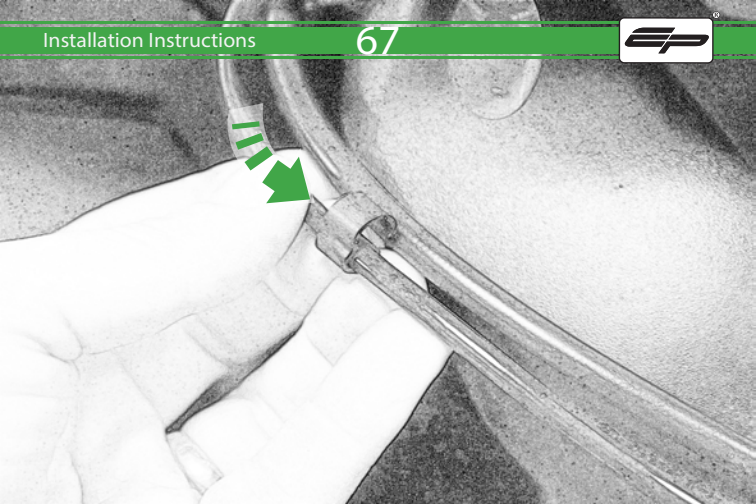

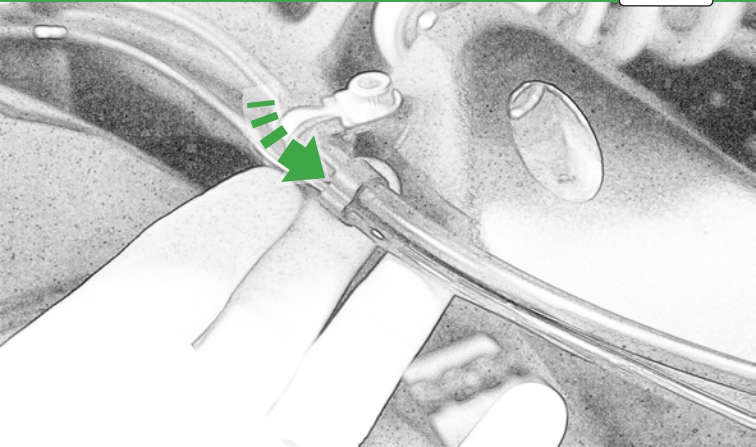

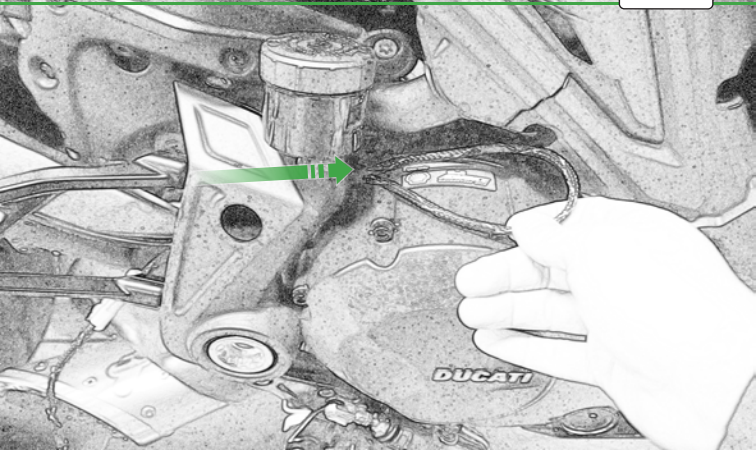



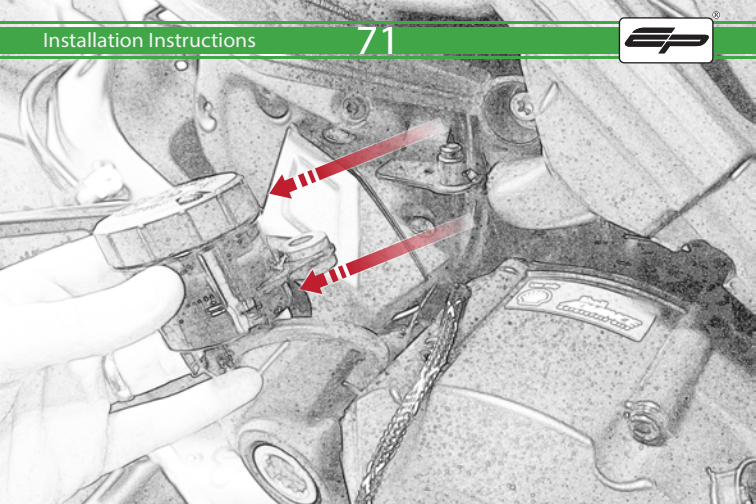

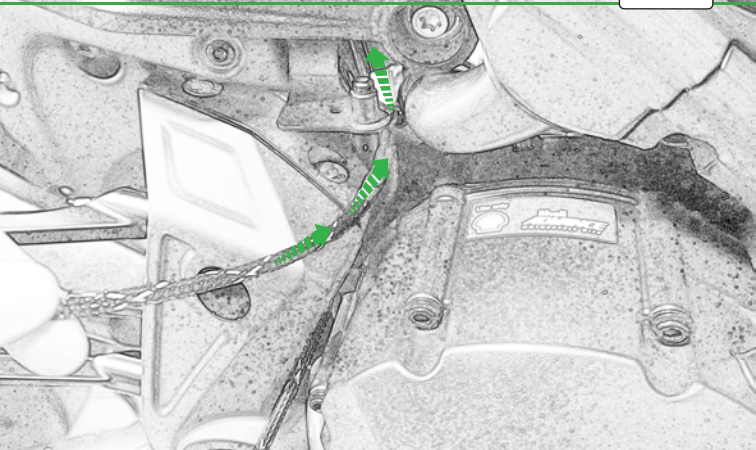

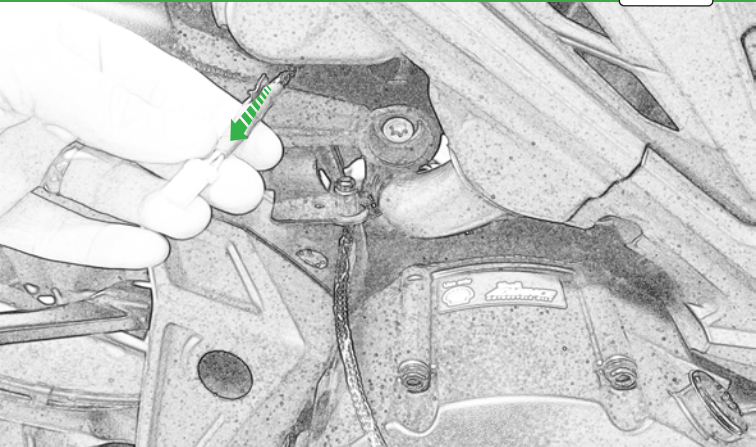

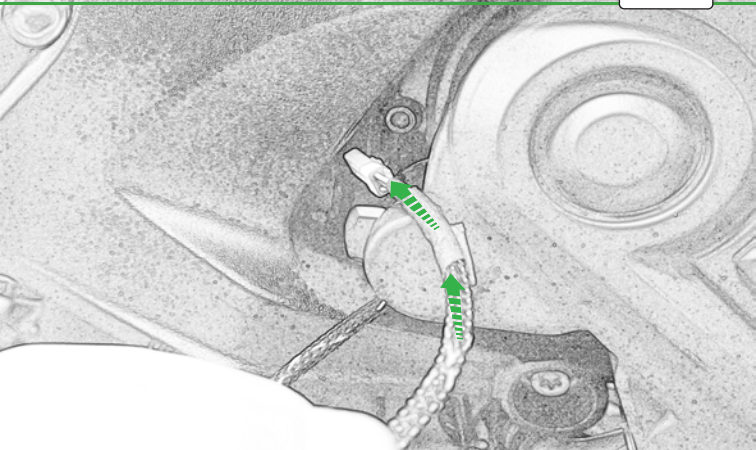

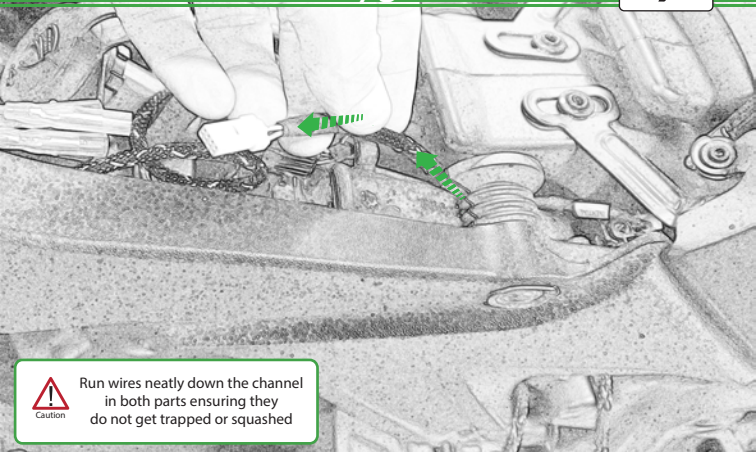

Caution

Run wires neatly down the channel in both parts ensuring they do not get trapped or squashed

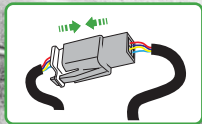
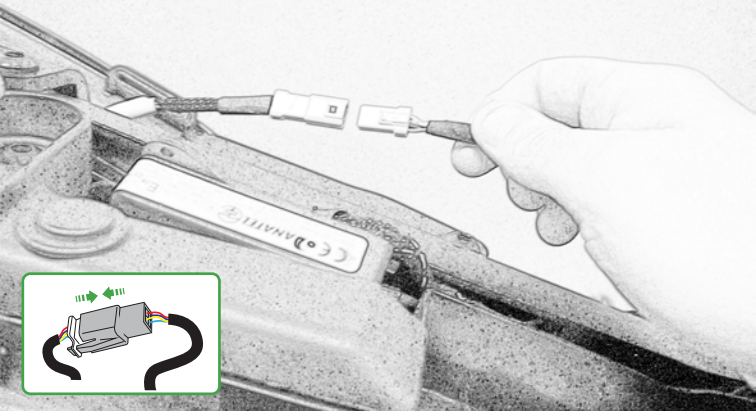

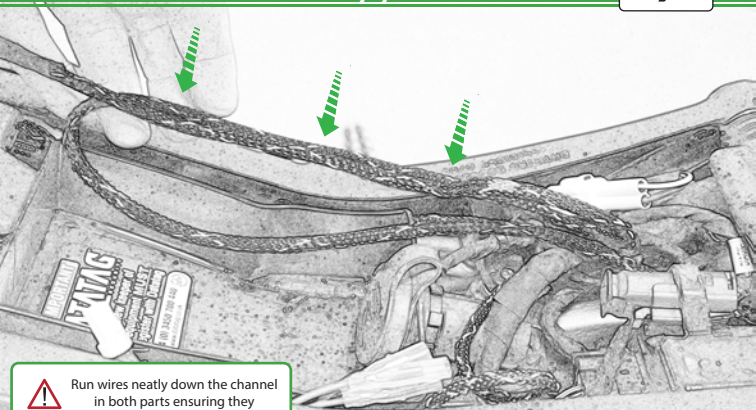

Caution

Run wires neatly down the channel in both parts ensuring they do not get trapped or squashed

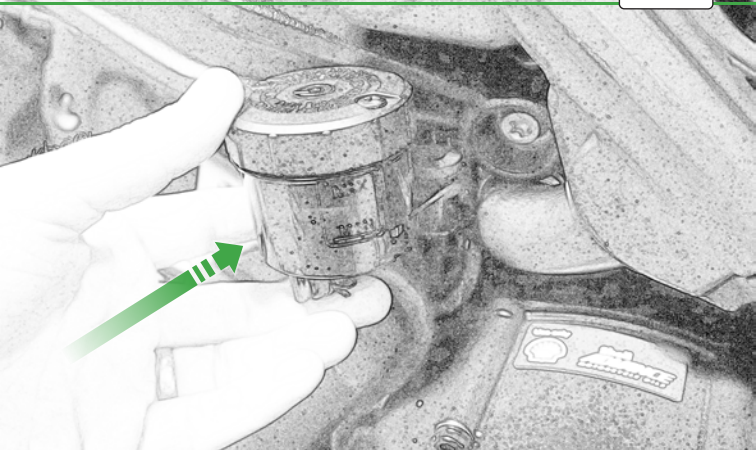



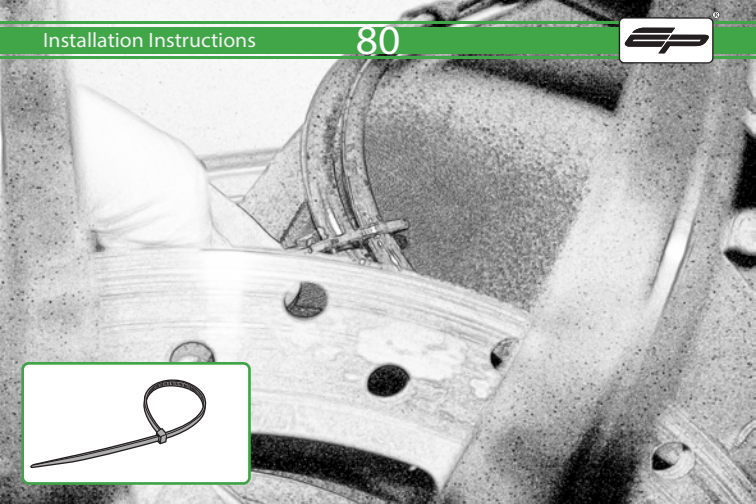

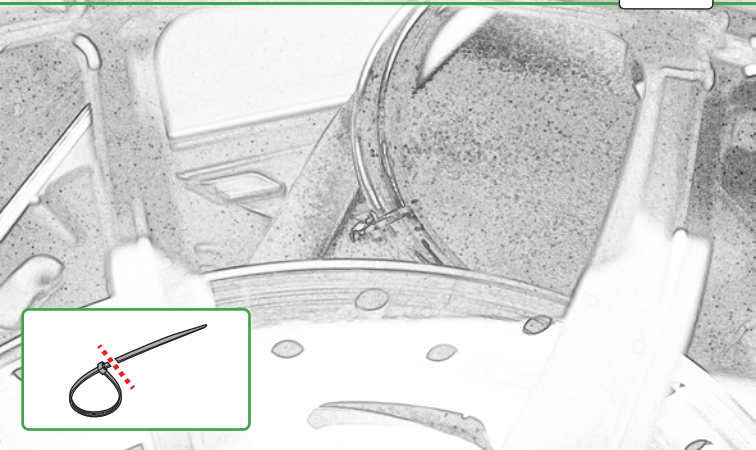







Reverse Stages

56 - 60

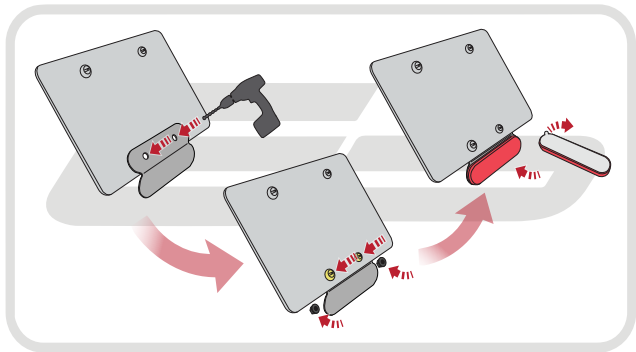

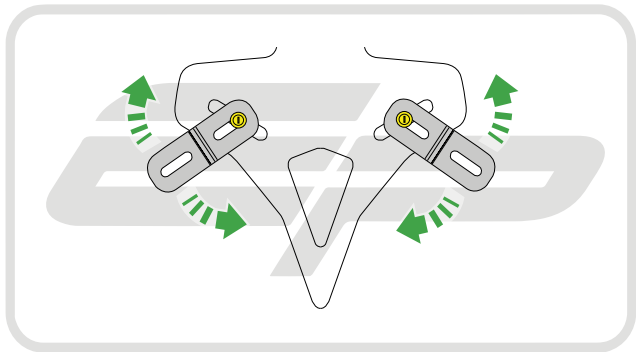



 **ESSENTIAL CHECKS** 

After installation of your tail tidy ensure that the licence plate does not contact the rear tyre when suspension is fully compressed.

Ensure all electrics including indicators, tail light, brake light and licence plate light lights are working correctly before riding the motorcycle.

It is recommended that periodic inspections are made to ensure that all fixings are fully tightend.



EVOTECH®
P E R F O R M A N C E

www.evotech-performance.com