

**EVOTECH**®  
P E R F O R M A N C E

[www.evotech-performance.com](http://www.evotech-performance.com)

Aprilia RS660 Tail Tidy  
Installation Instructions



## Kit Contents PRN015278

- |                                   |                                   |
|-----------------------------------|-----------------------------------|
| (A) 1 x Reflector Kit             | (M) 2 x M4 Flange Nuts            |
| (B) 1 x Retro Light               | (N) 2 x M6 Special Washer         |
| (C) 1 x Light Bracket             | (O) 2 x M6 x 40 Button Head Bolts |
| (D) 1 x Loom Connector            | (P) 2 x M6 x 35 Caphead           |
| (E) 1 x Number Plate Bracket      | (Q) 2 x M6 x 60 Caphead           |
| (F) 1 x Main Body Left            | (R) 4 x Indicator Stems           |
| (G) 1 x Main Body Right           | (S) 4 x M6 x 12 Button Head Bolts |
| (H) 1 x Mounting Plate            | (T) 4 x M4 x 10 Button Head Bolts |
| (I) 1 x Cover Plate               |                                   |
| (J) 1 x Special Spacer            |                                   |
| (K) 1 x M6 x 35 Button Head Bolts |                                   |
| (L) 2 x M4 x 8 Button Head Bolts  |                                   |



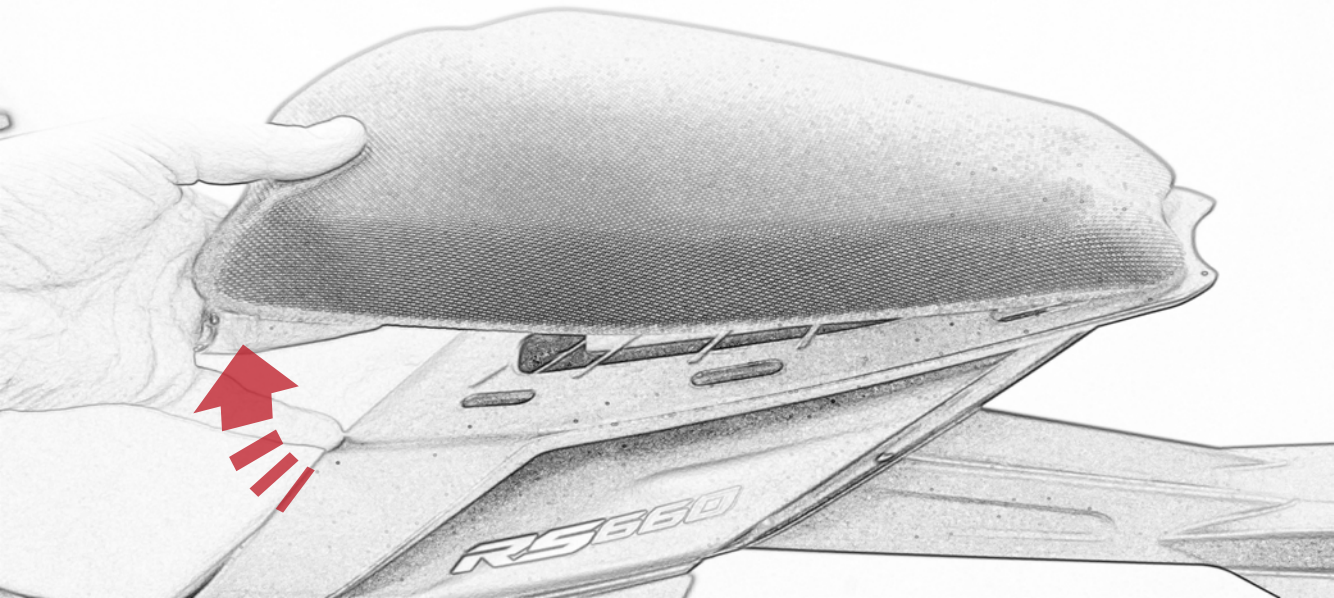

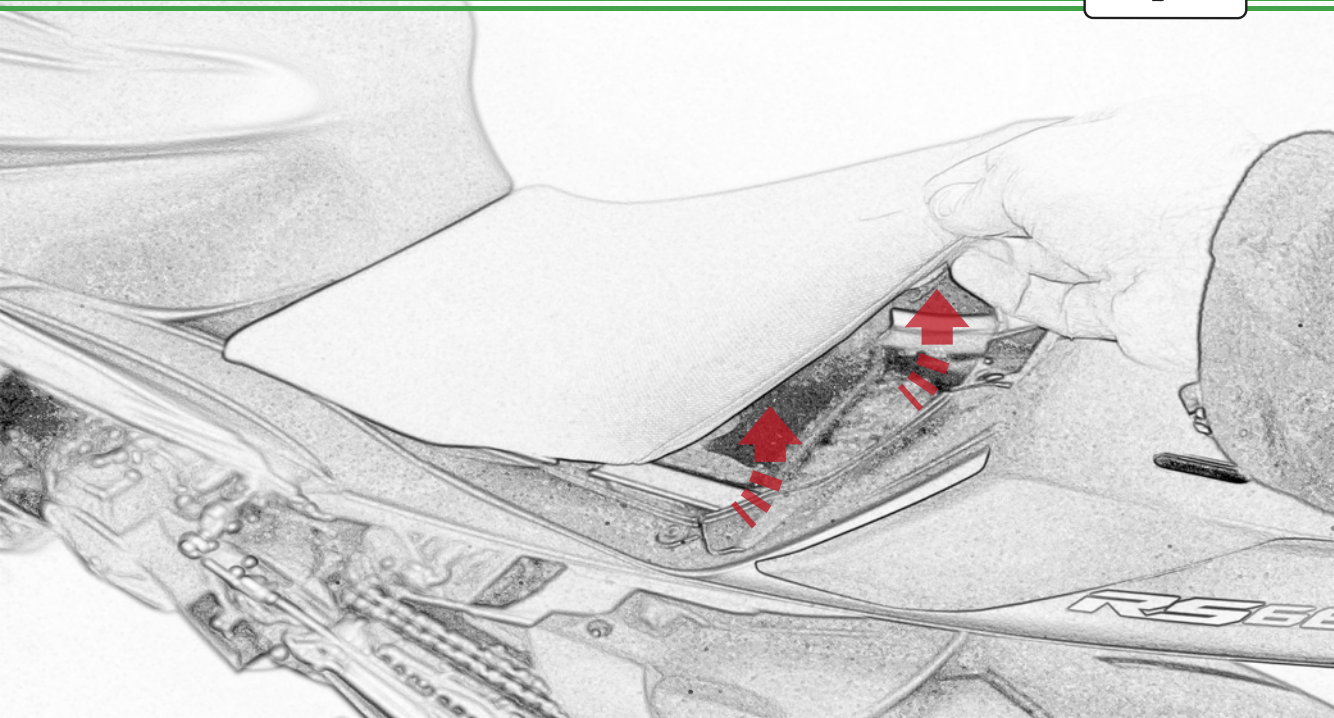

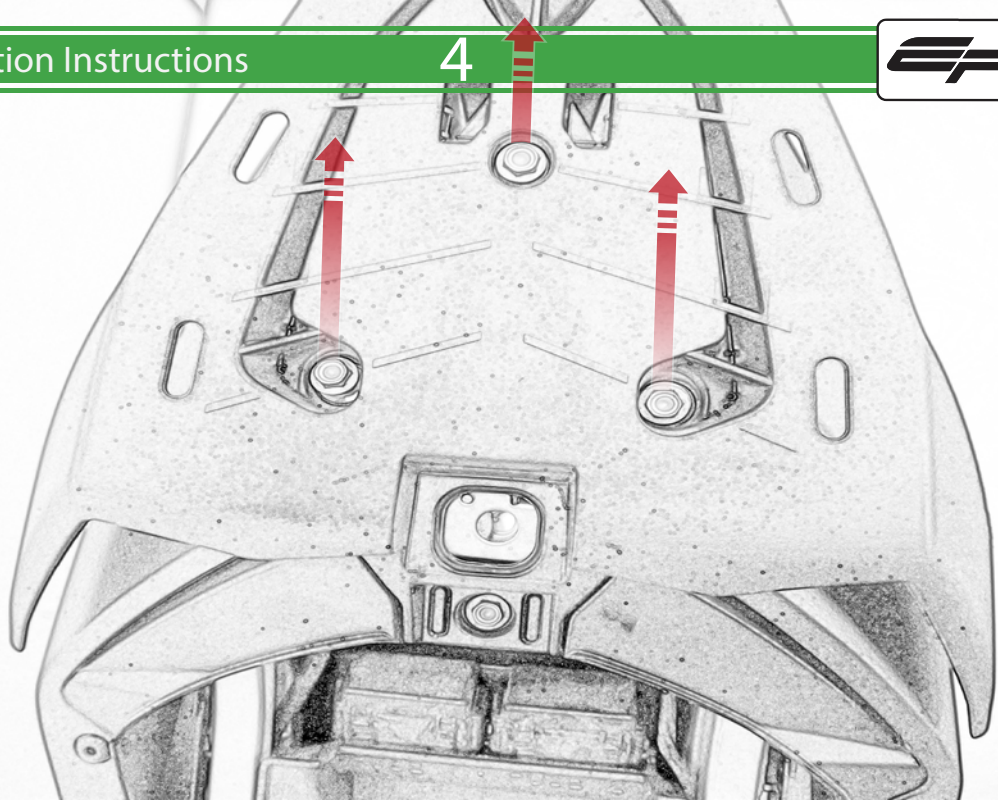

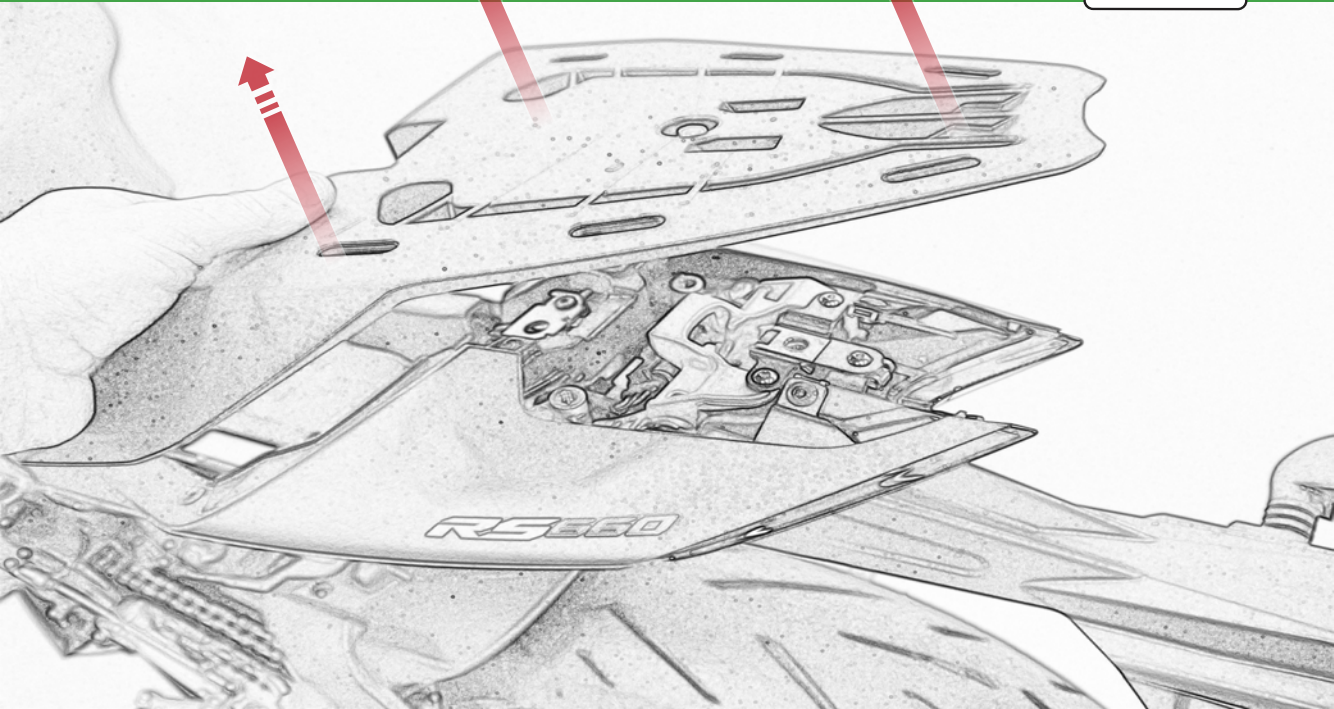

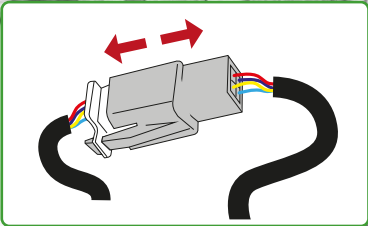
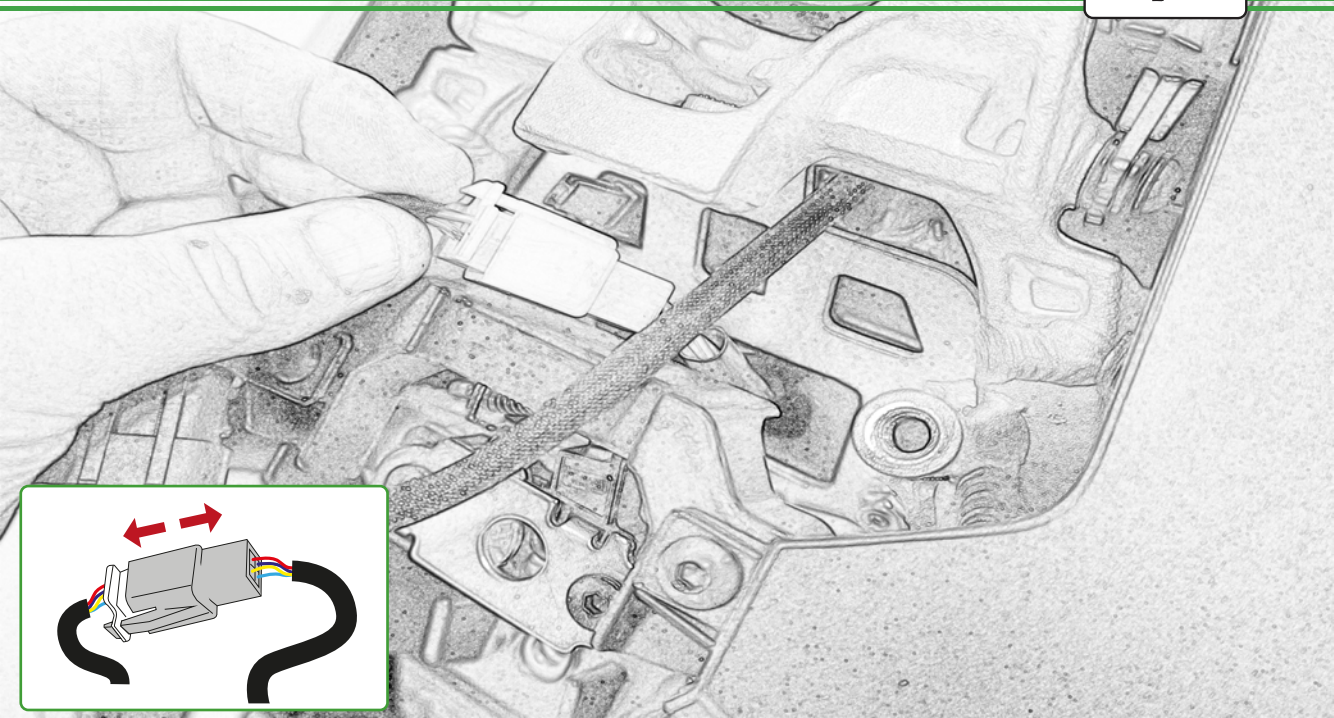



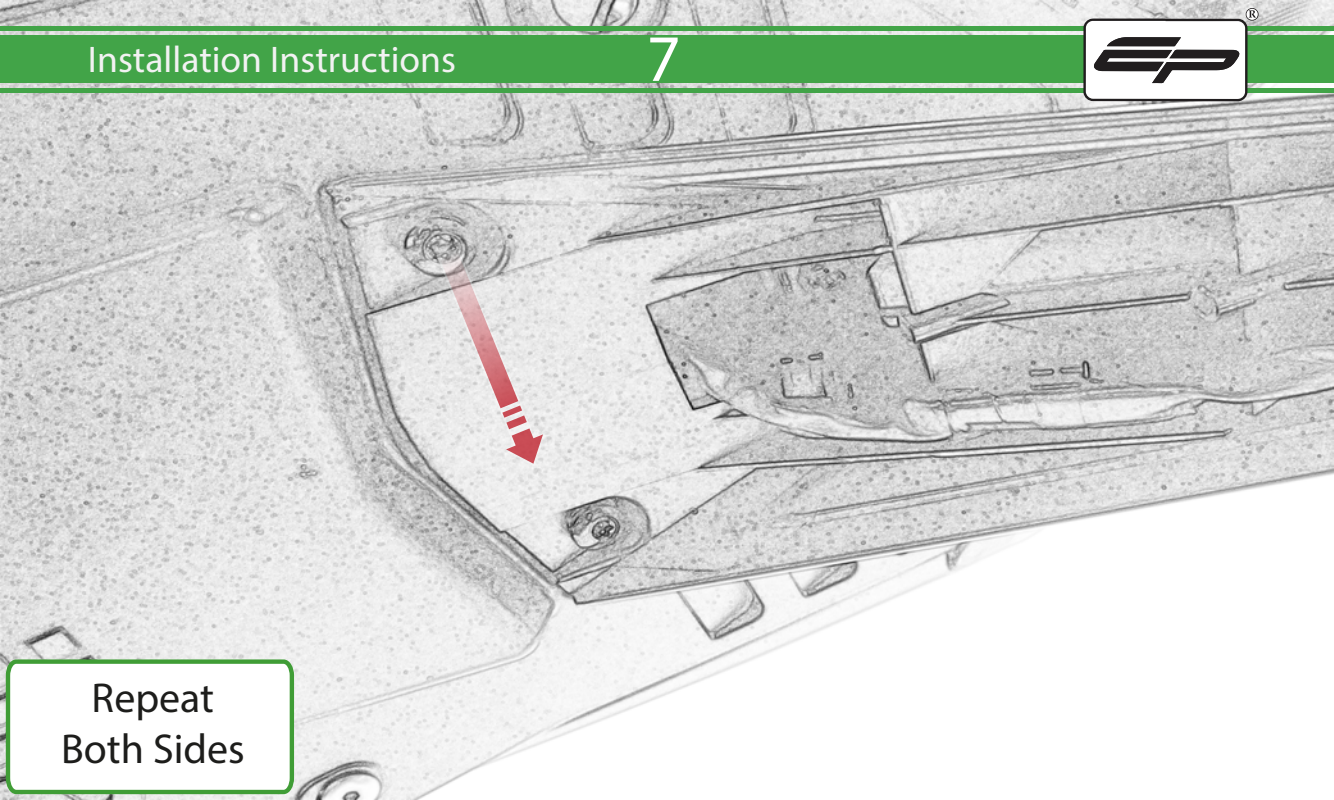

Repeat  
Both Sides



Repeat  
Both Sides

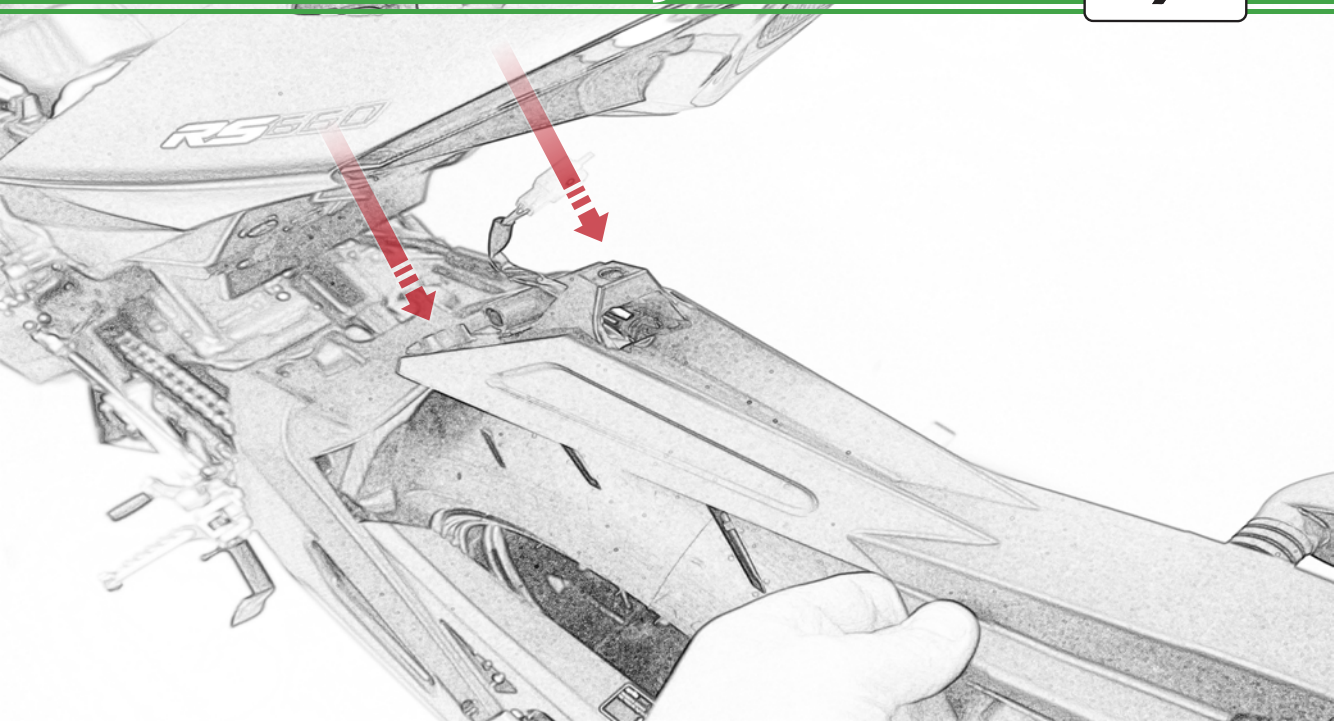

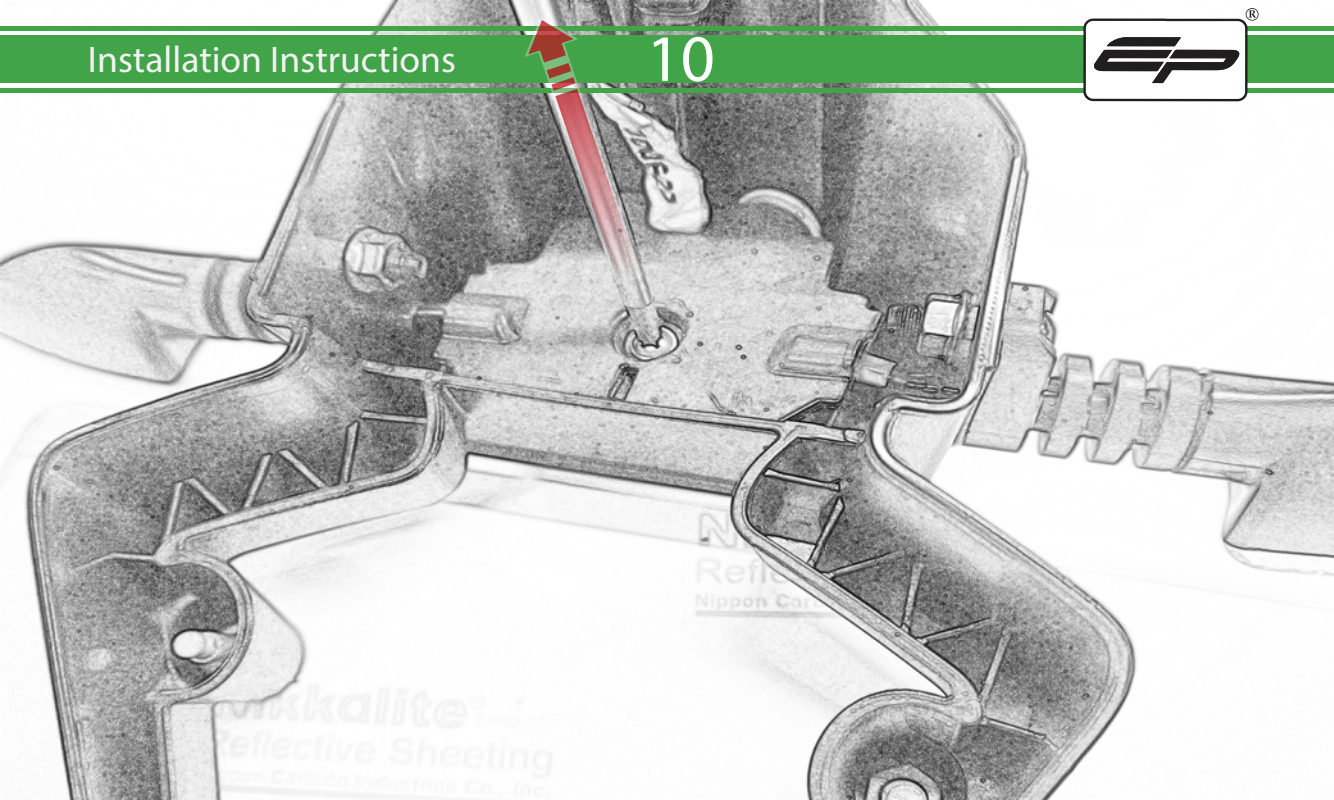

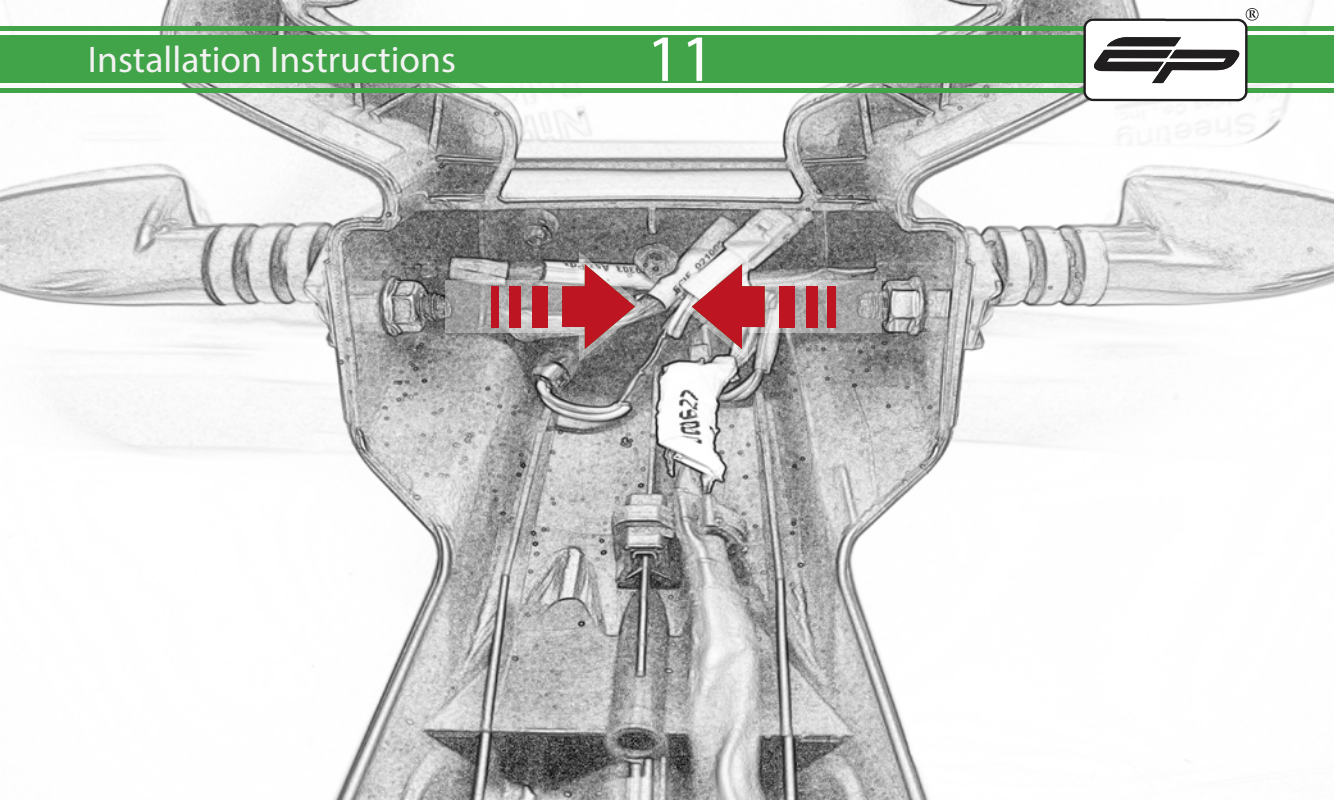

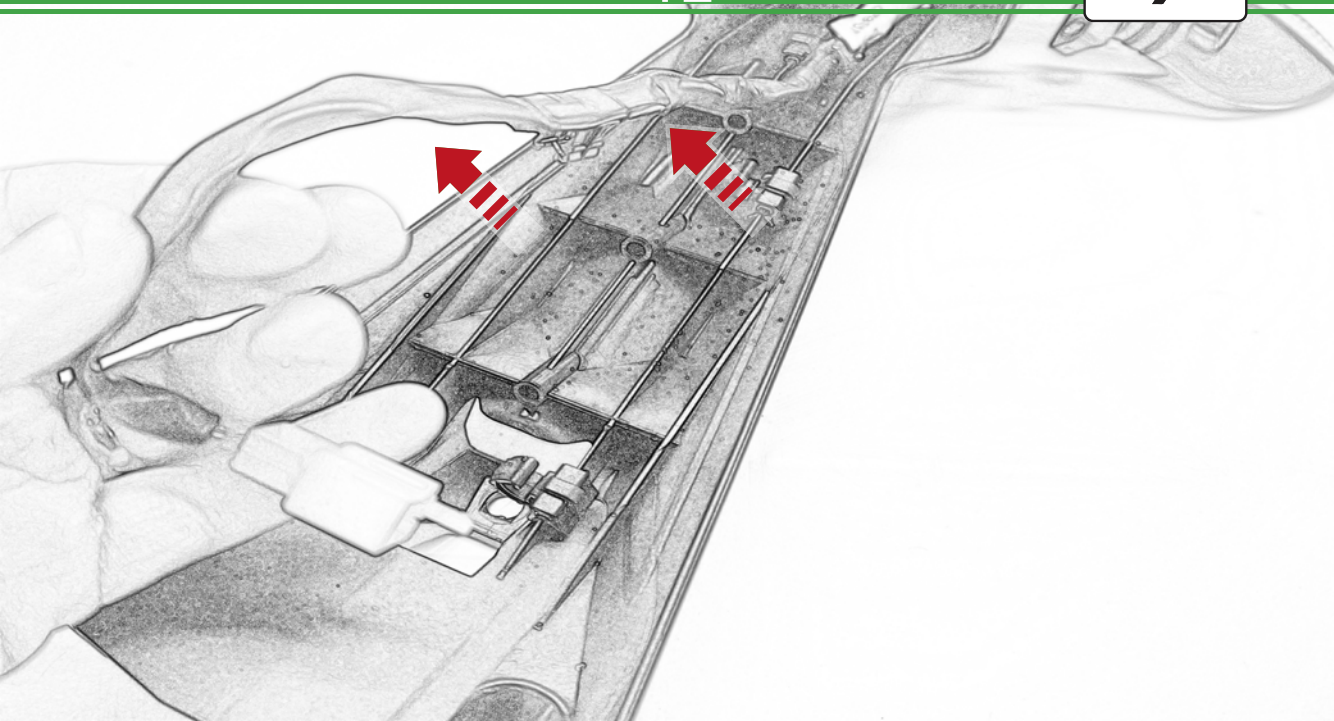

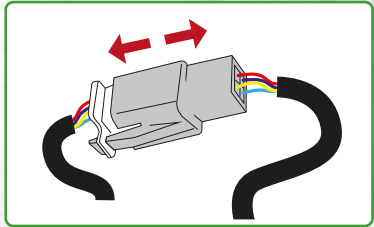
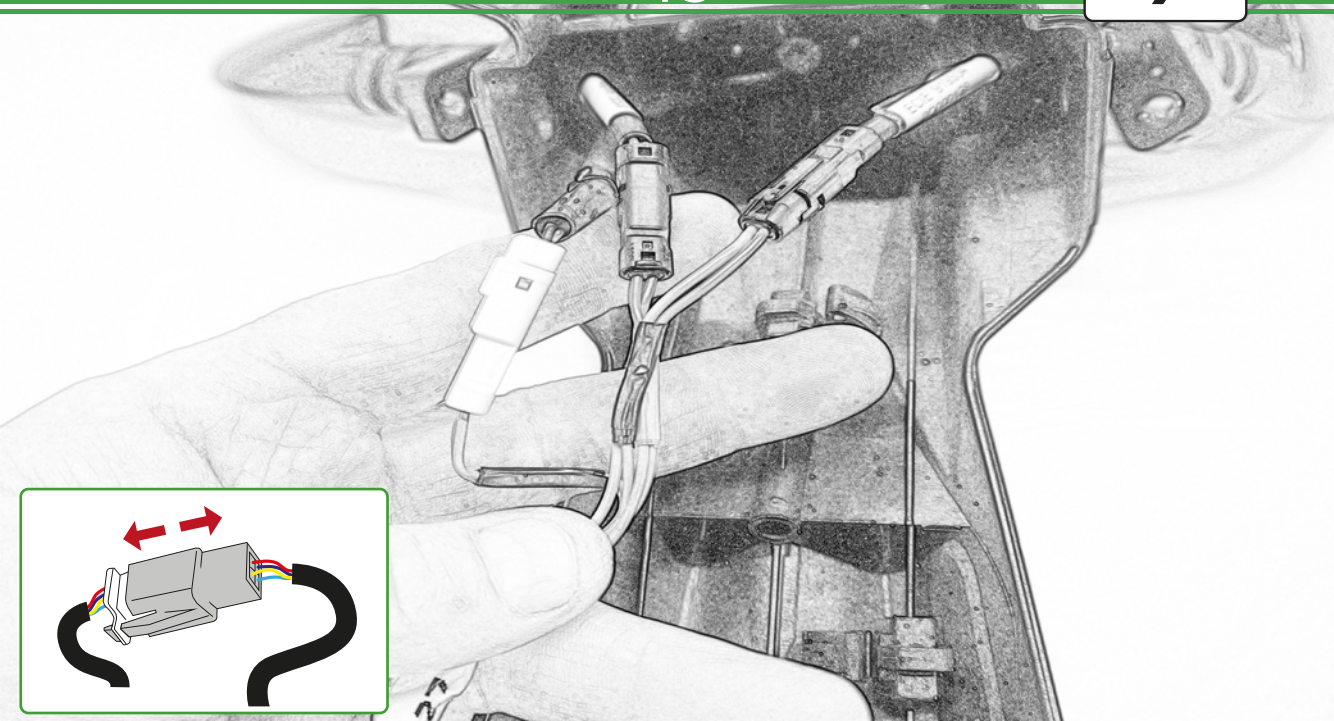

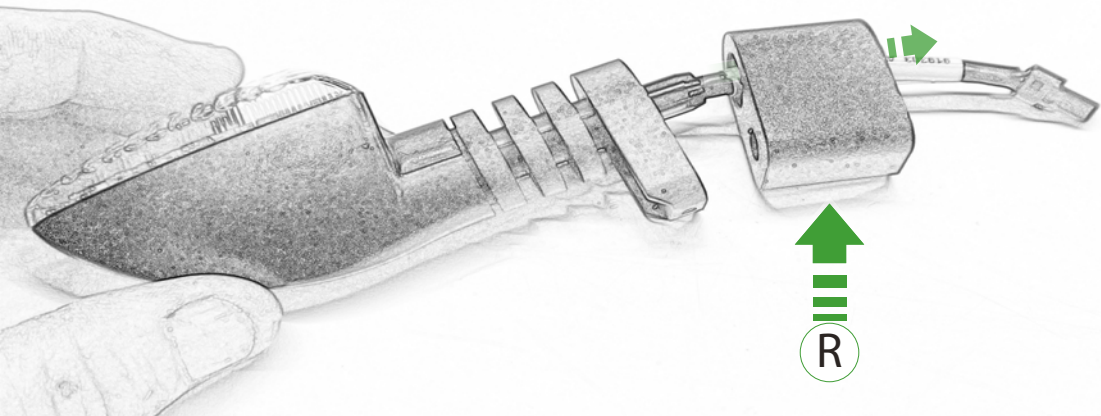



Repeat  
Both Sides

 Use 2 x Part R and K for wider  
Indicator Position

Caution



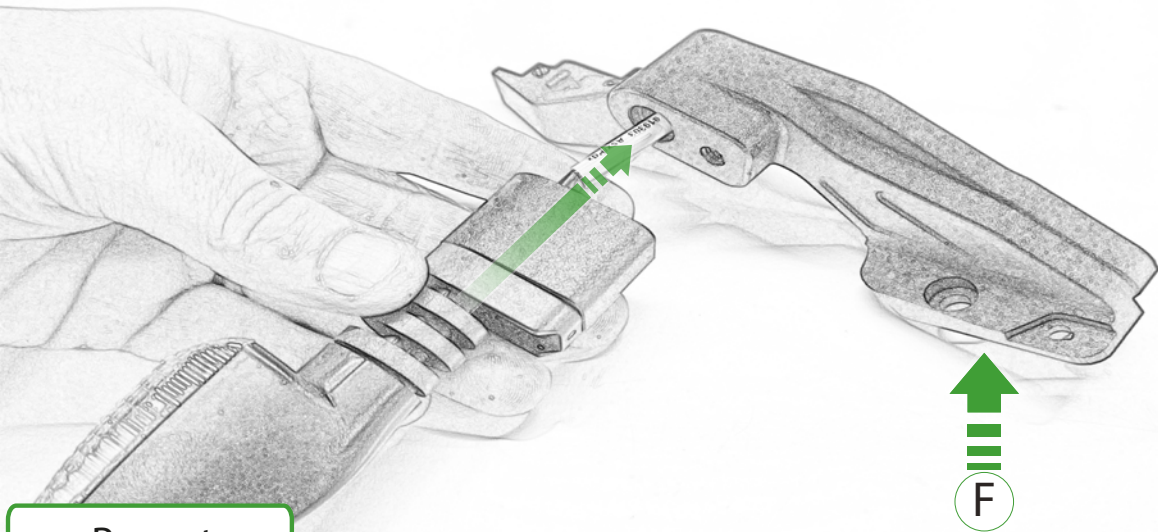

Repeat  
Both Sides

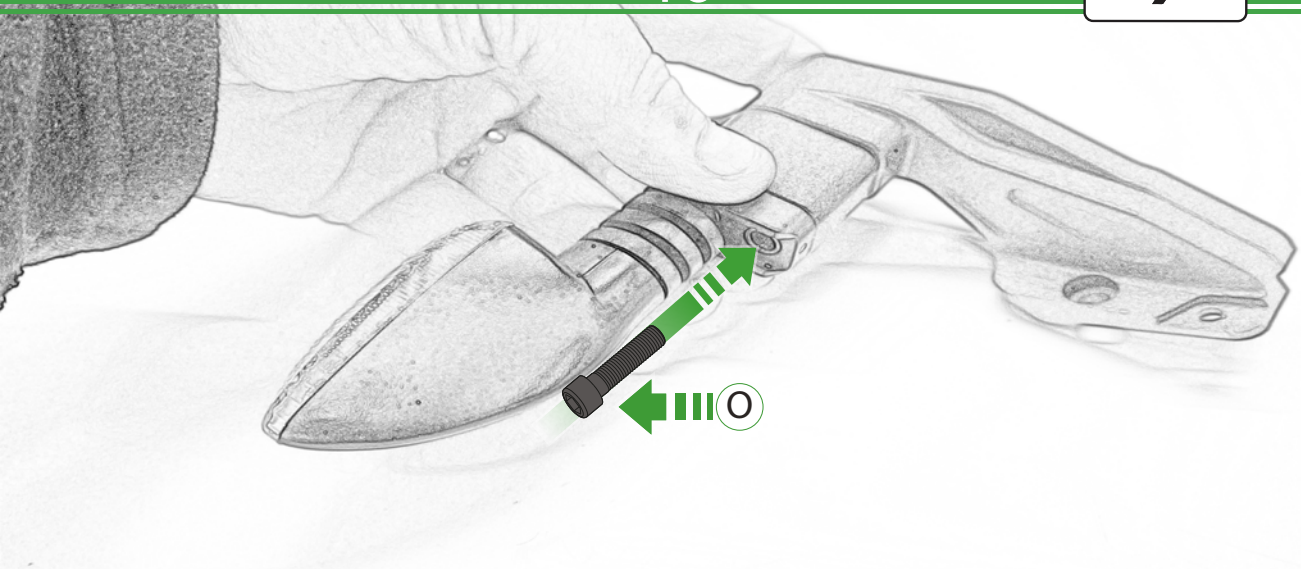

Repeat  
Both Sides

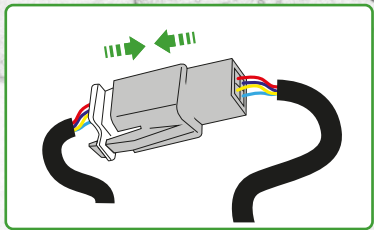
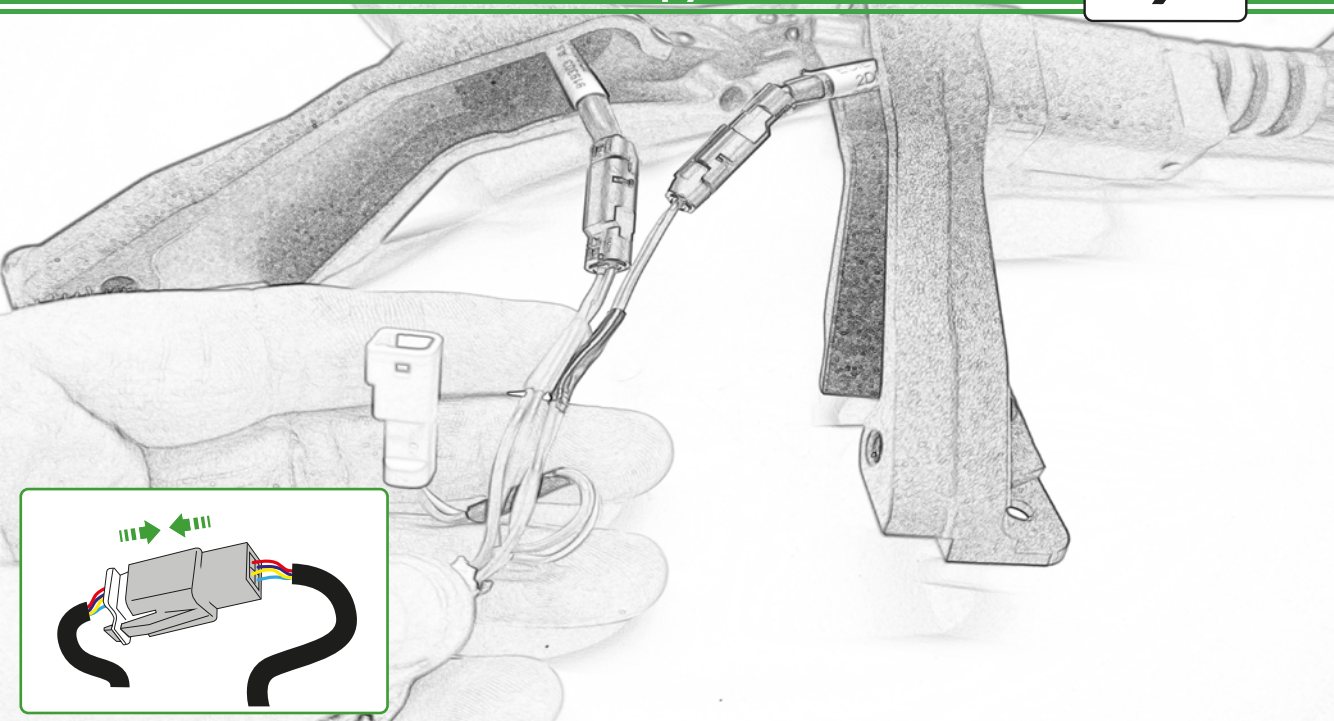

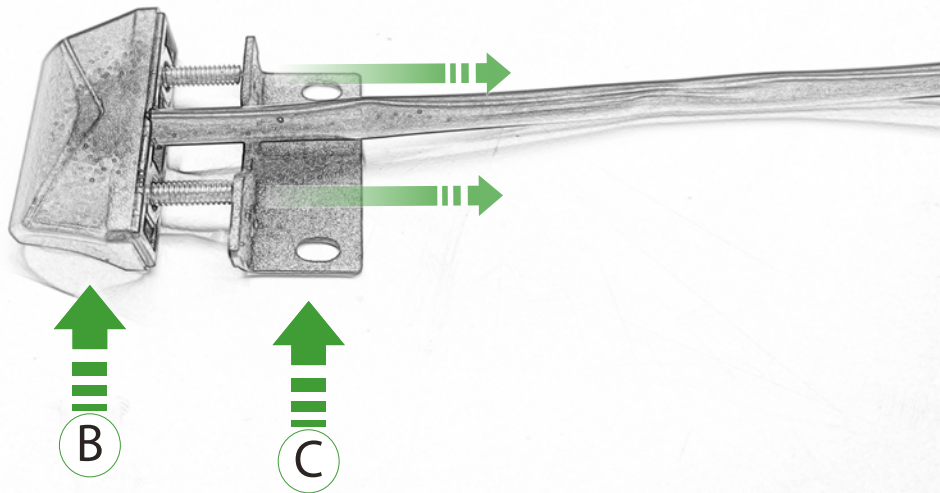

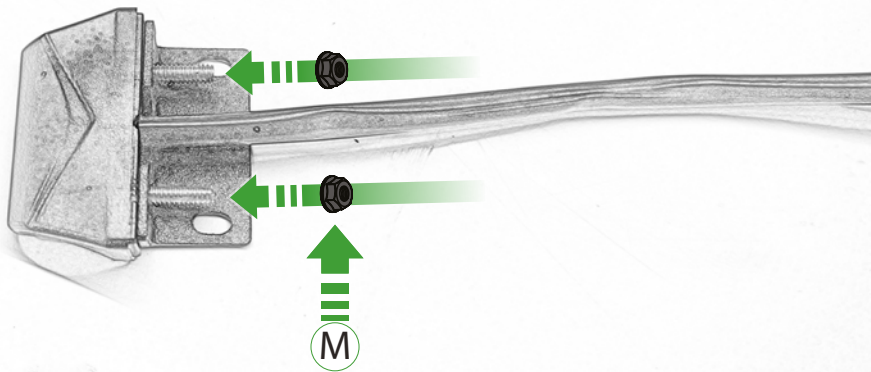

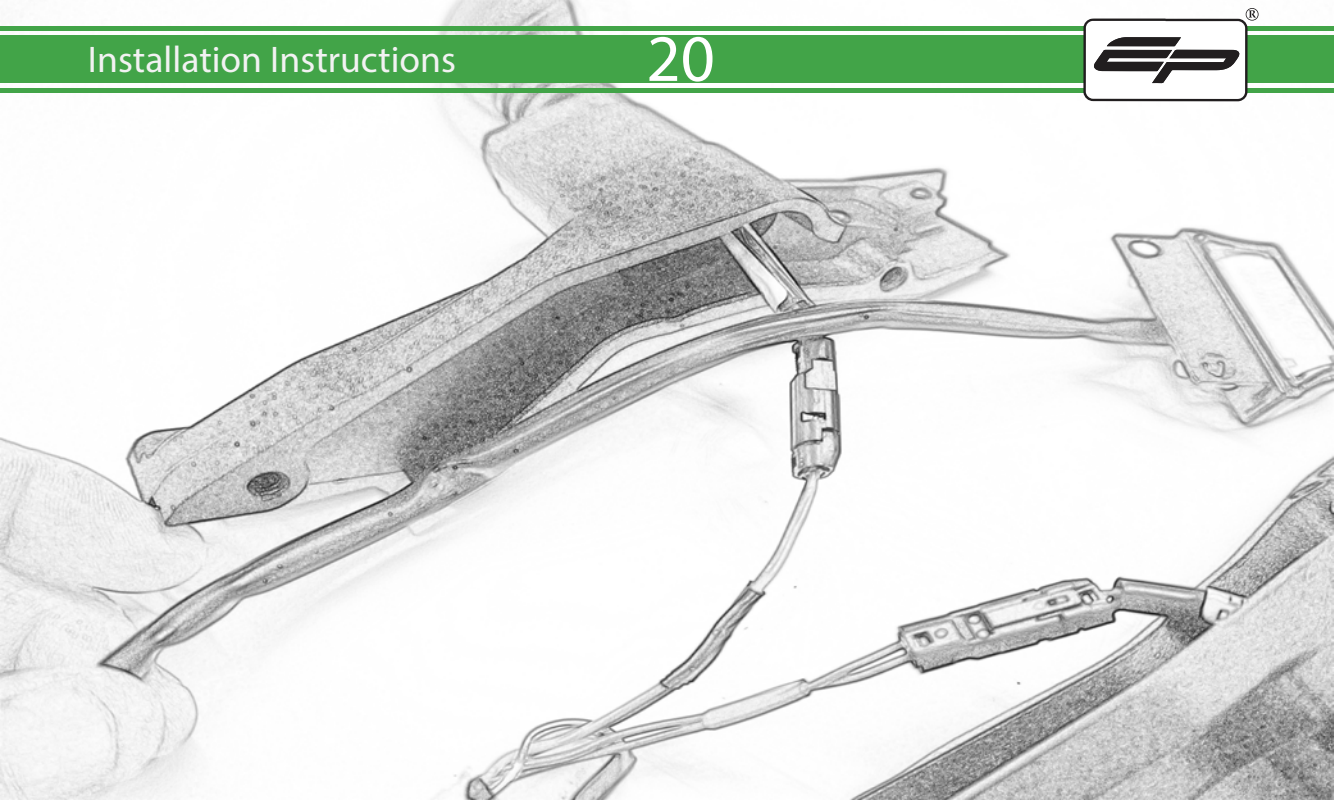

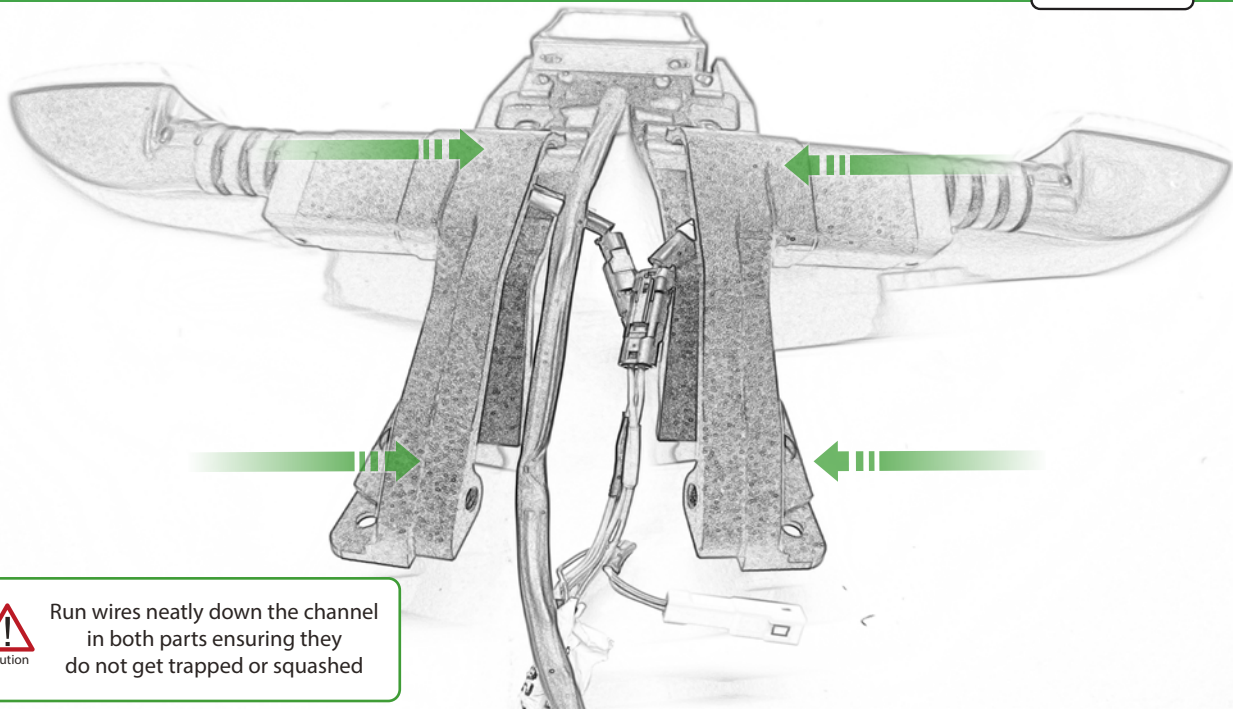

Caution

Run wires neatly down the channel in both parts ensuring they do not get trapped or squashed

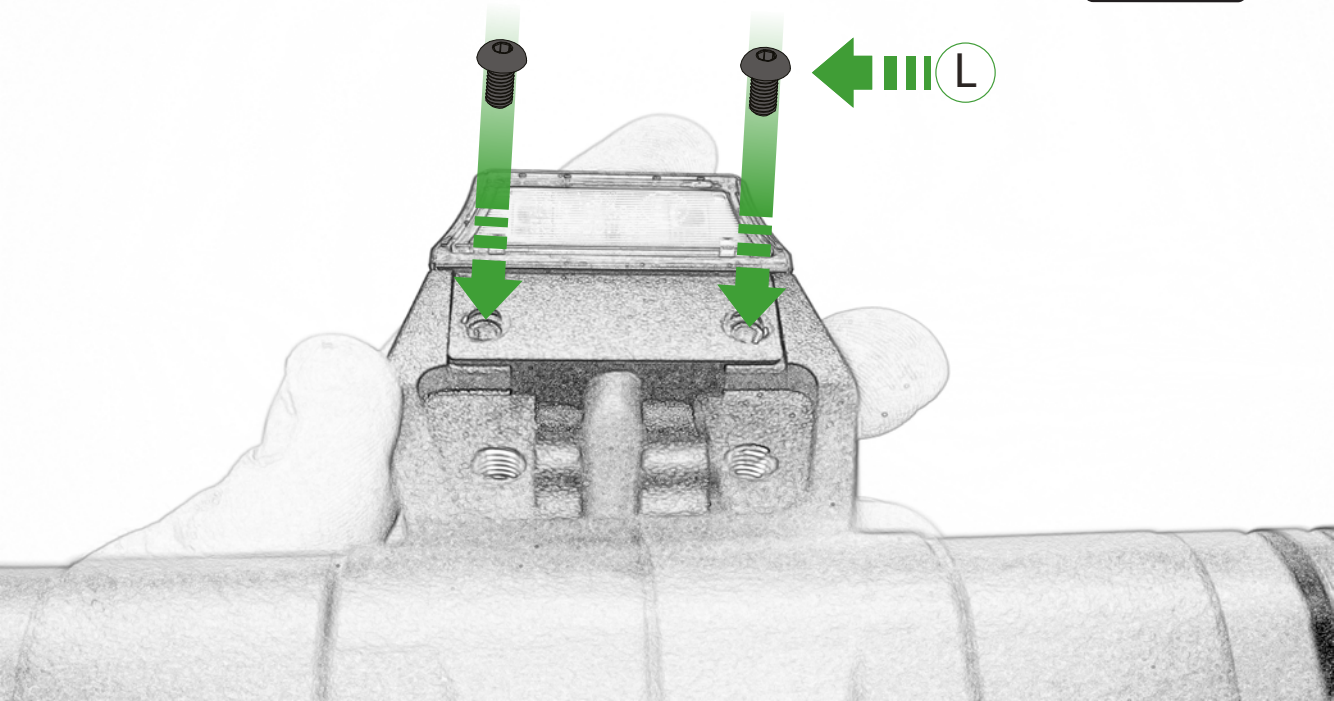



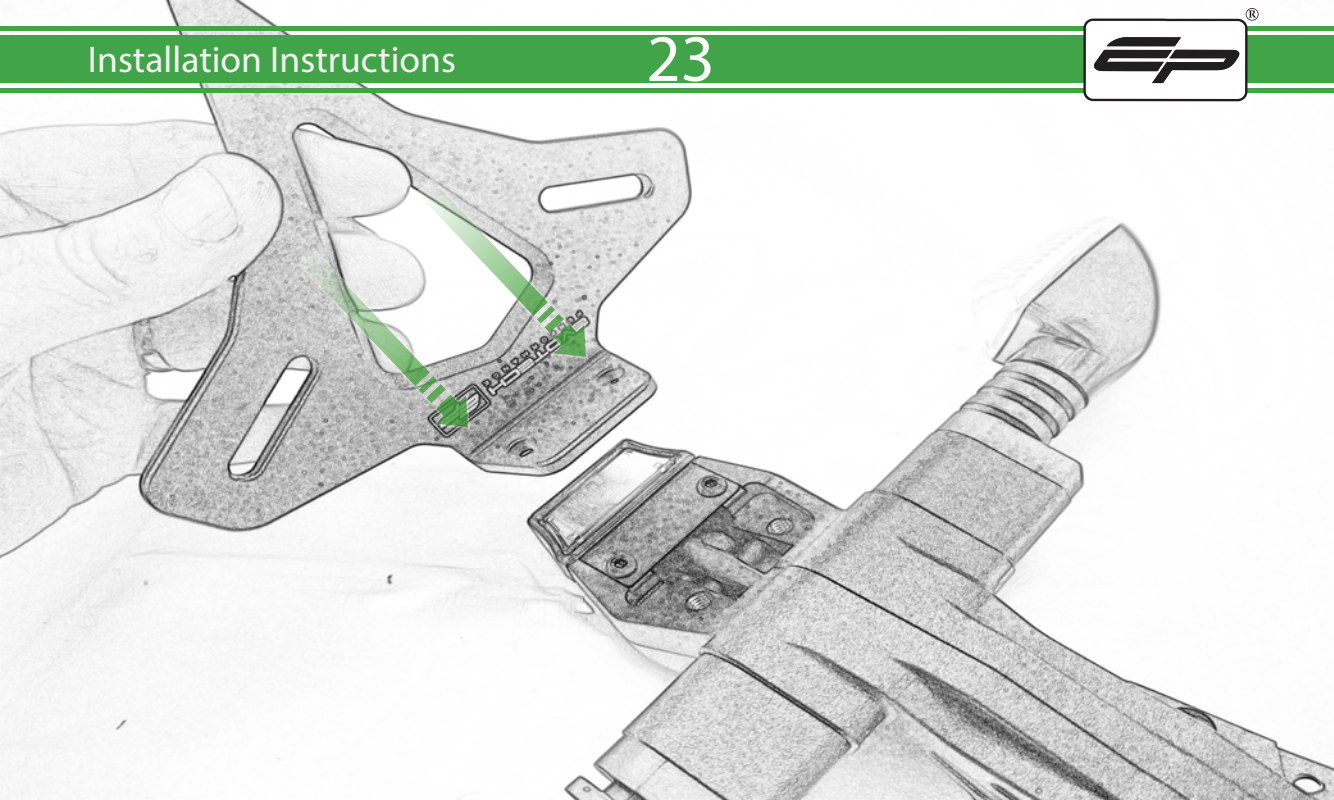

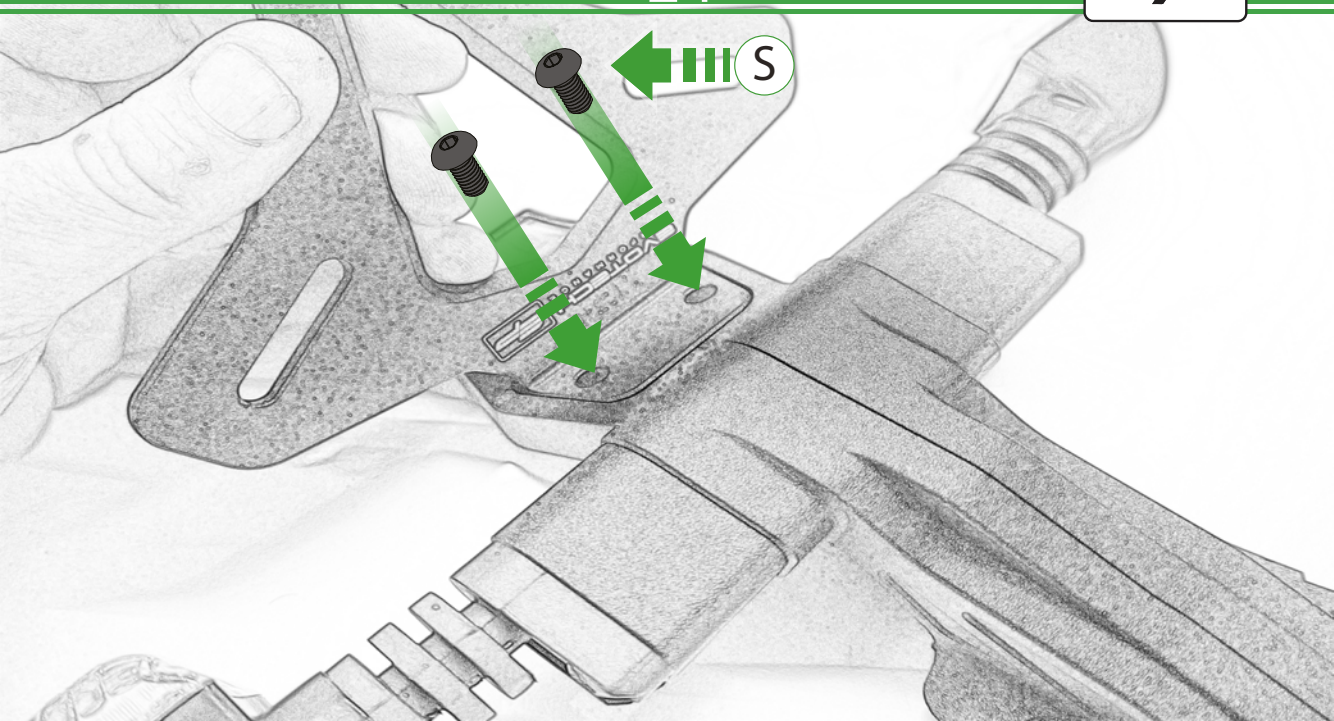

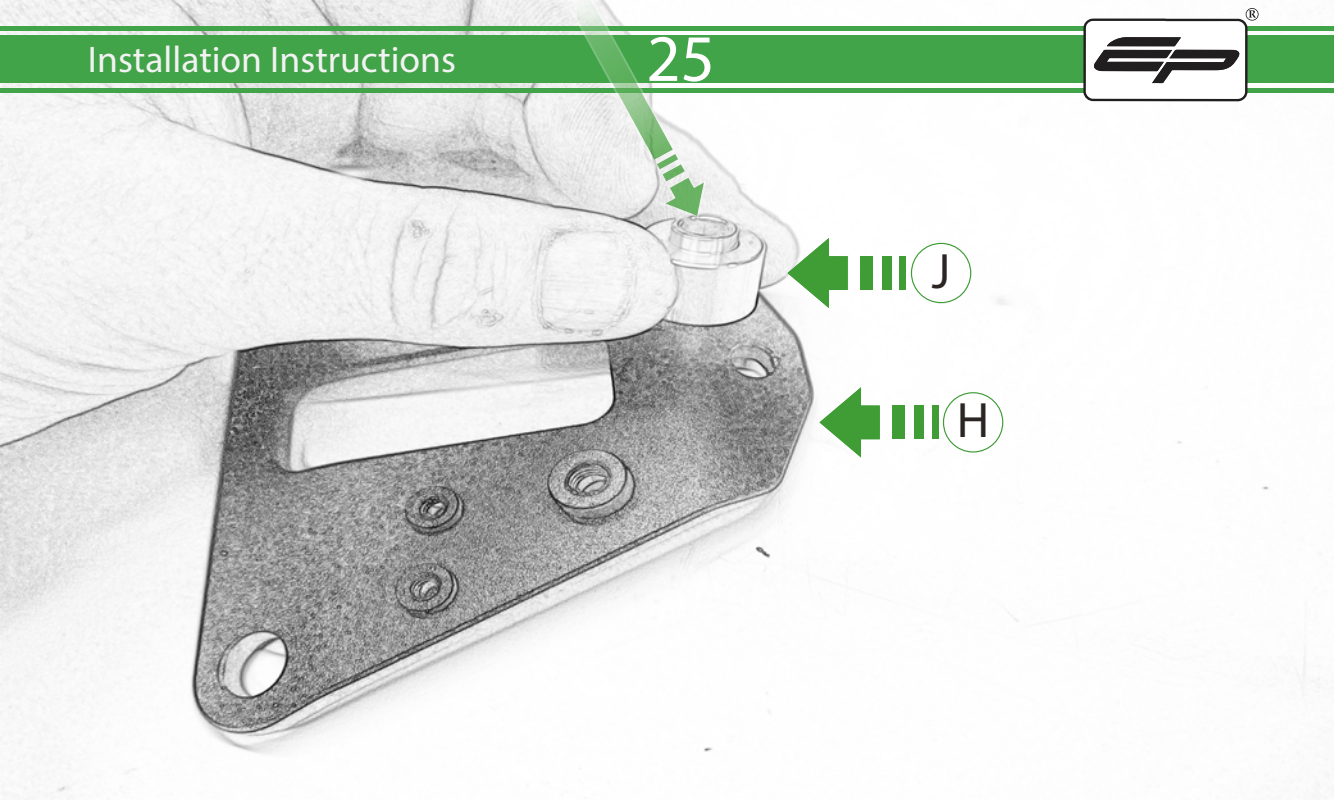

J

H

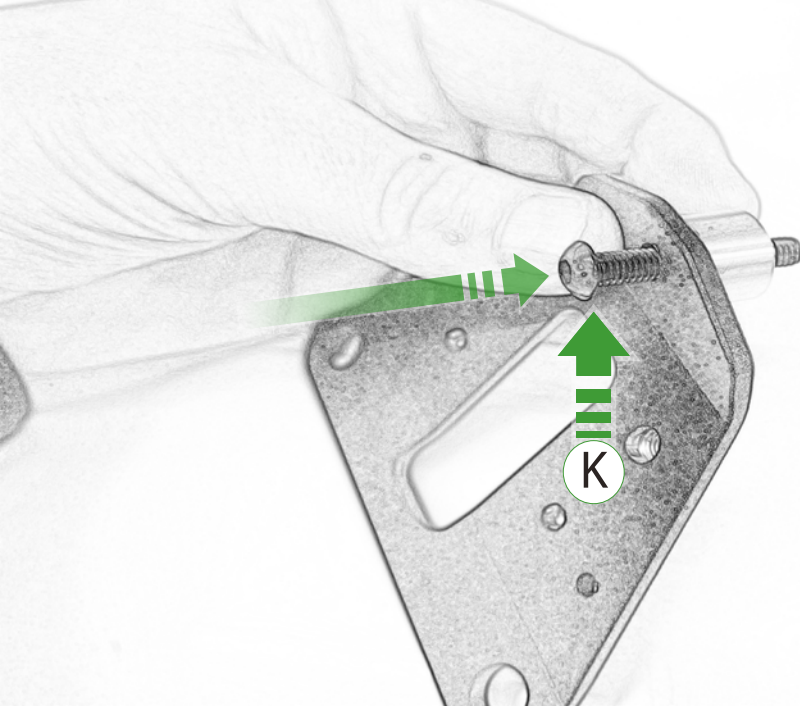

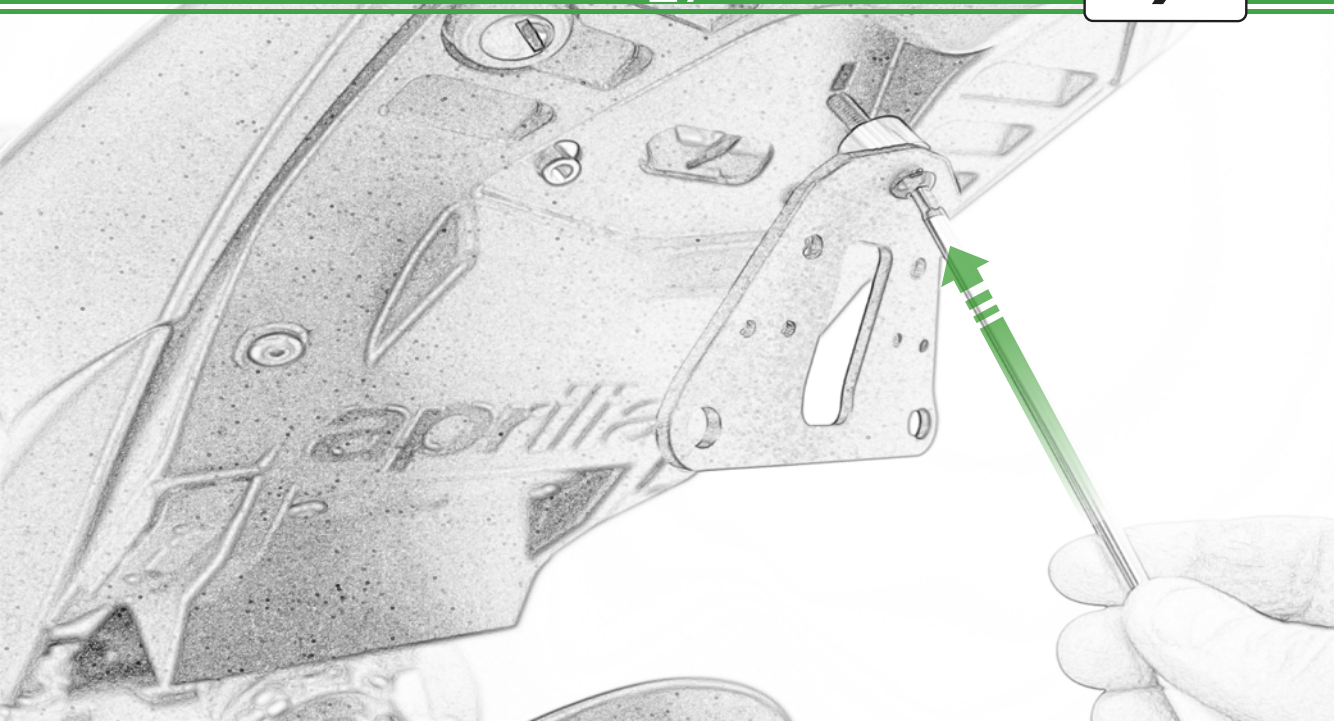



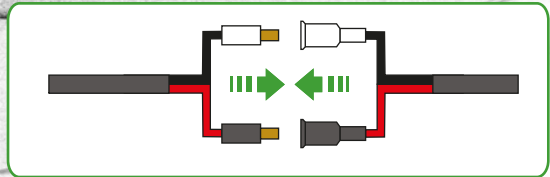
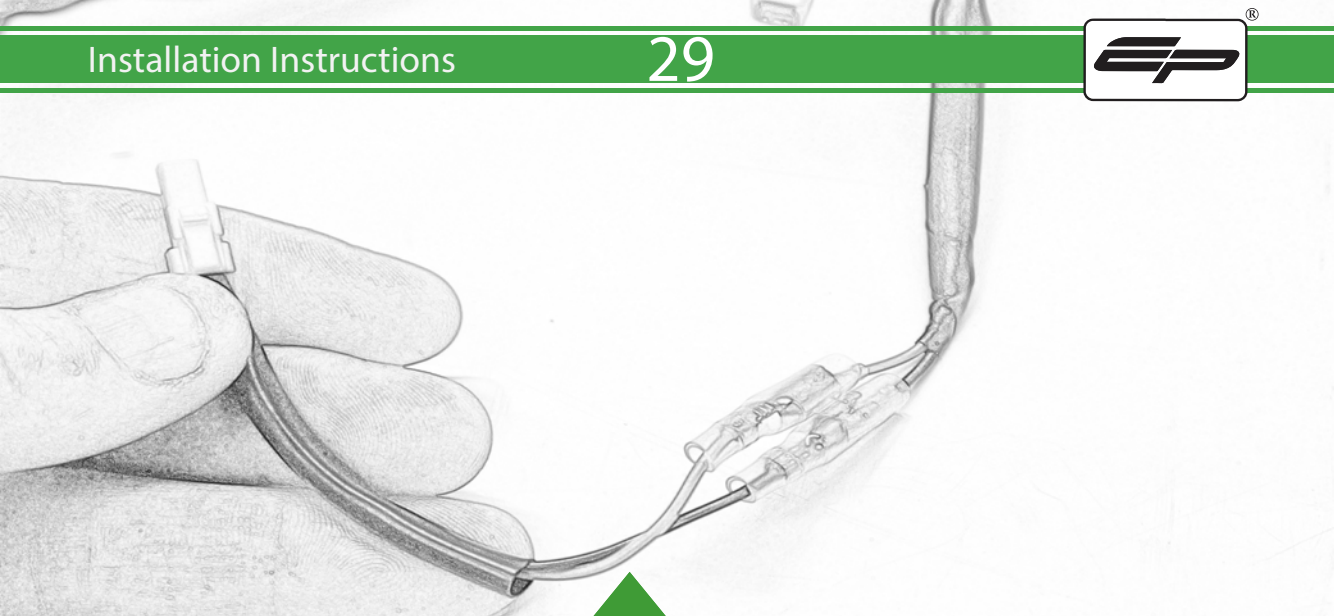

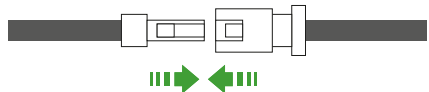
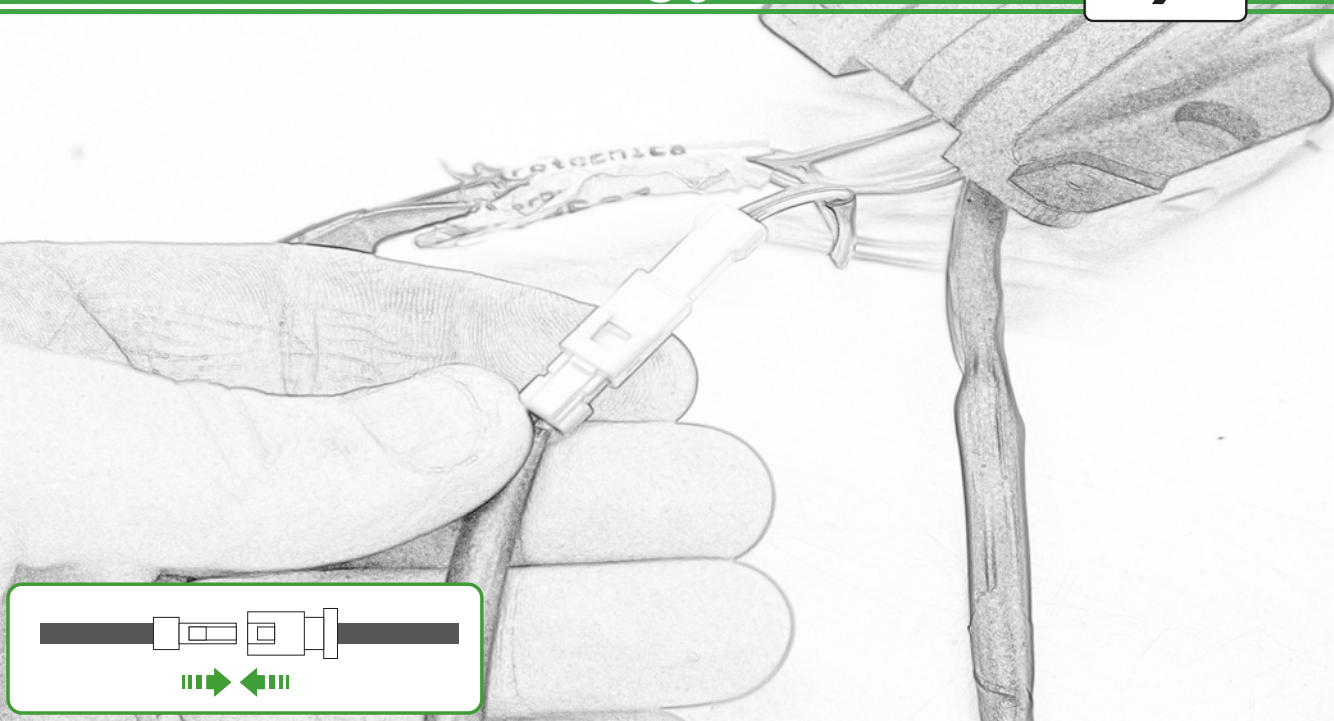



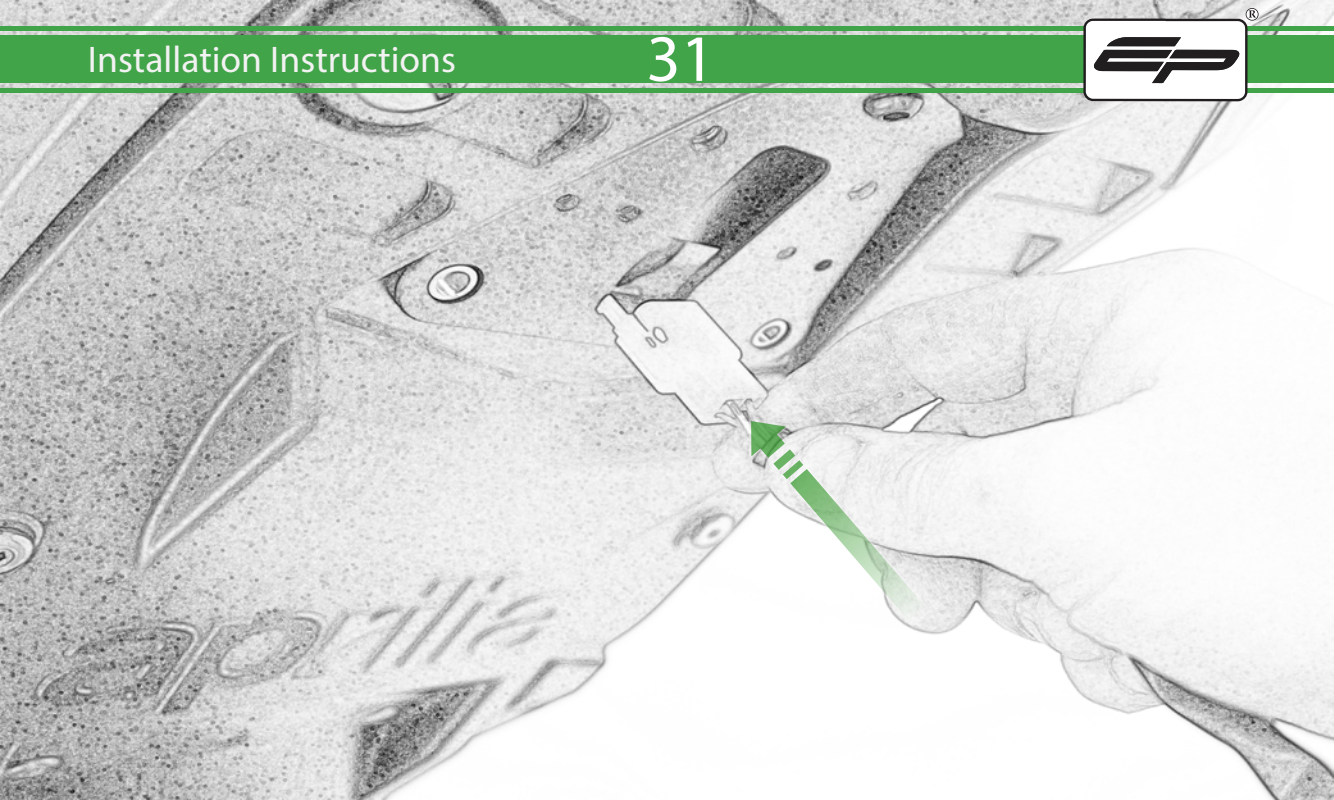

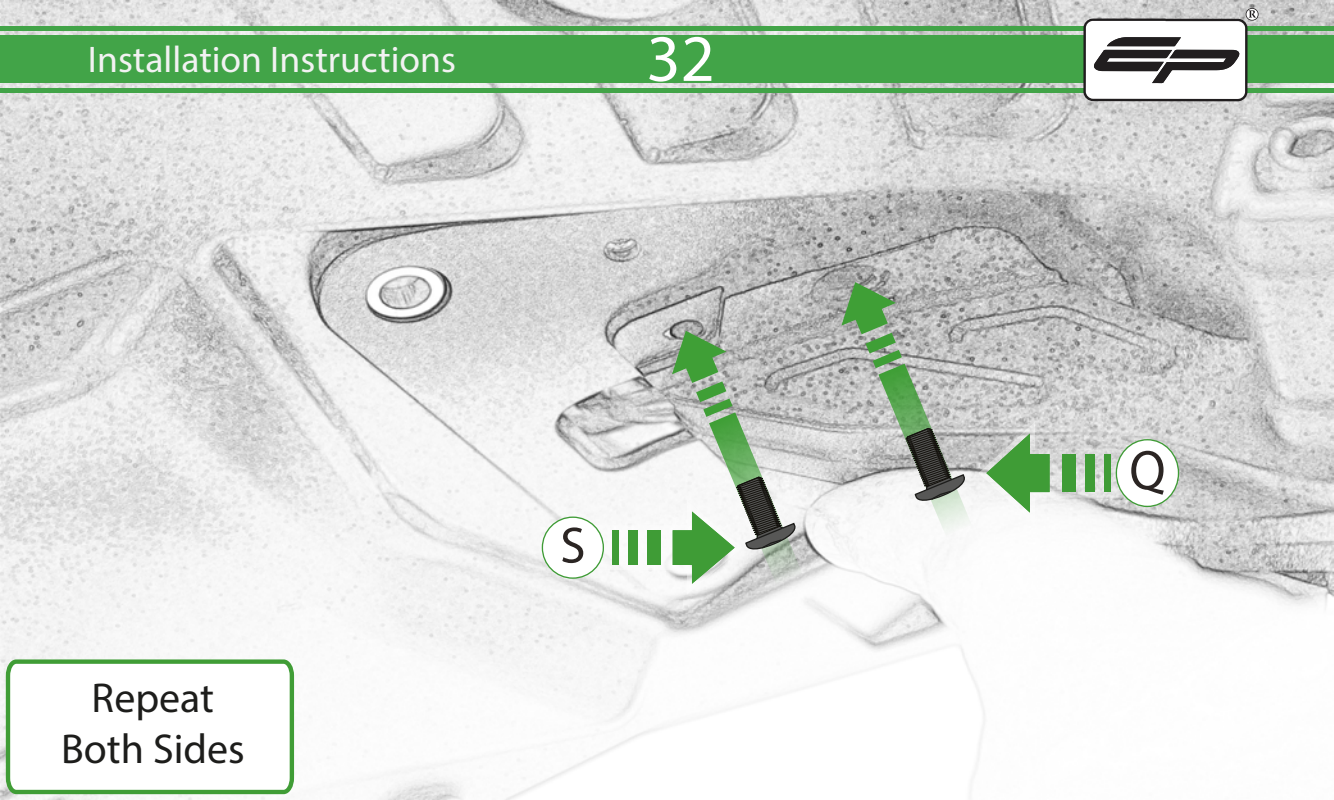

S

Q

Repeat  
Both Sides

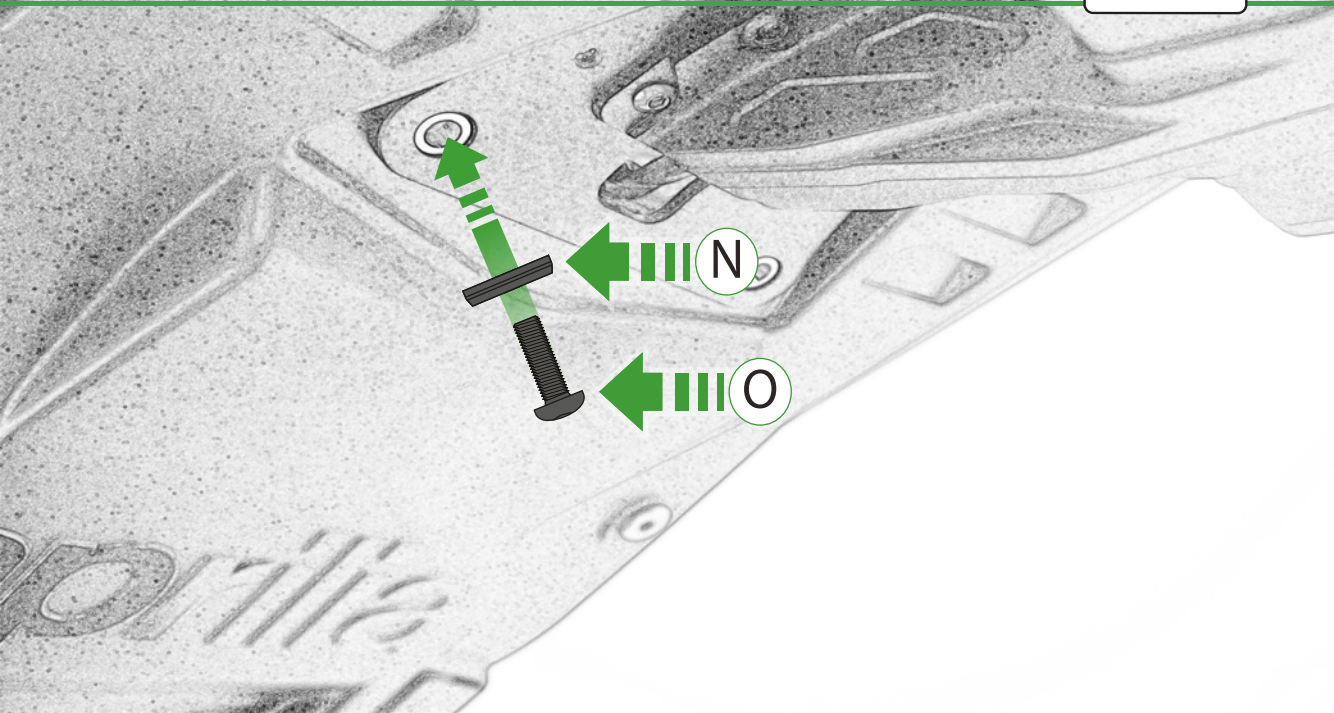

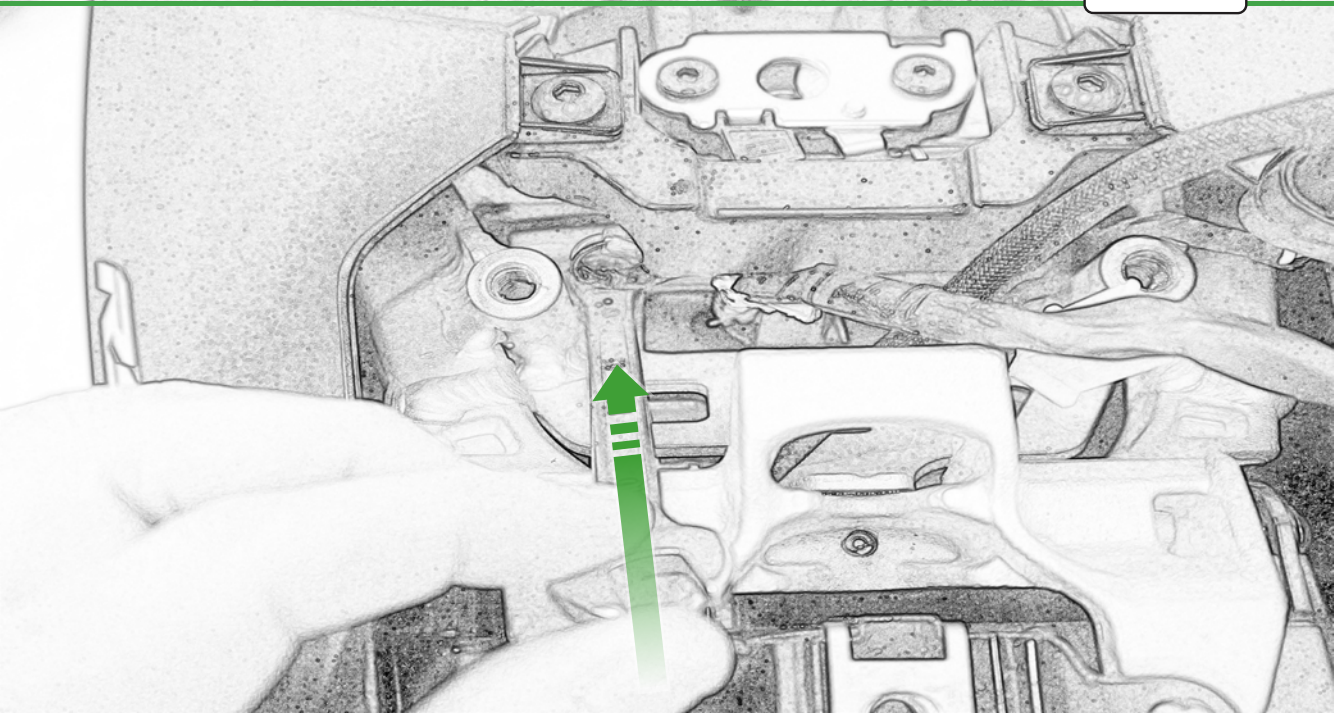

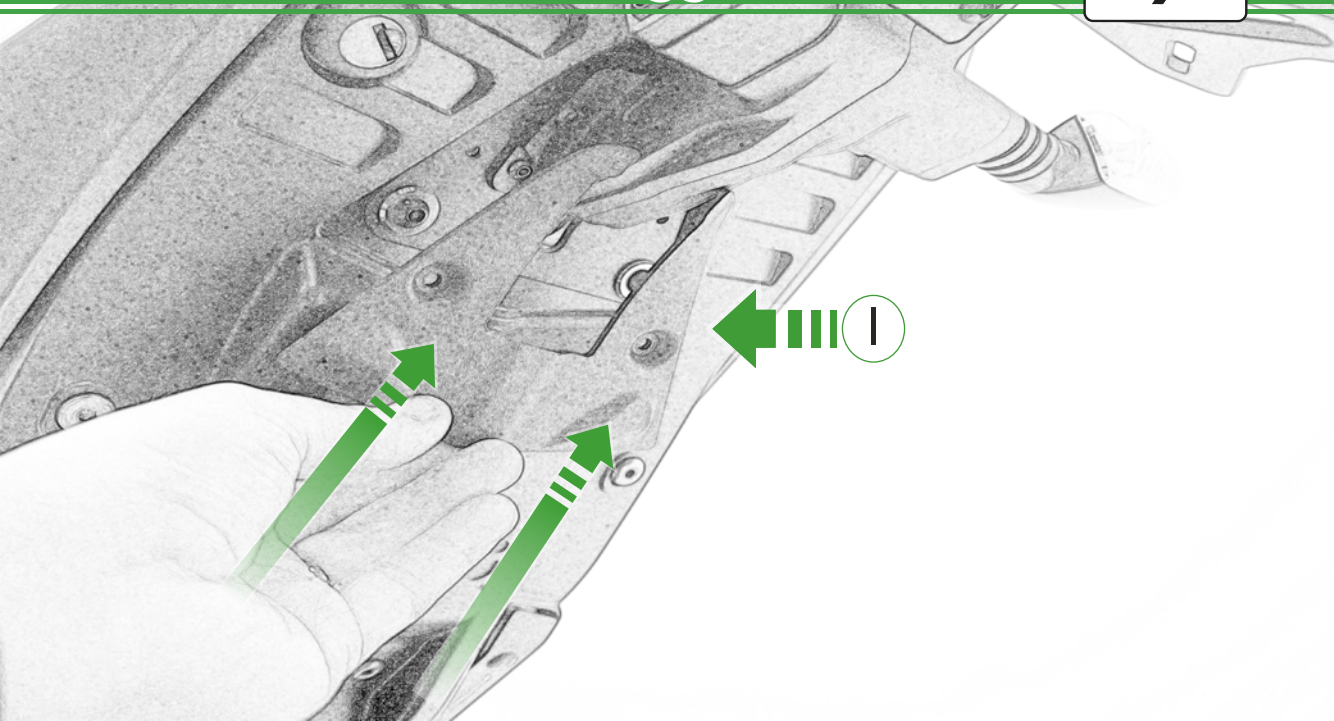



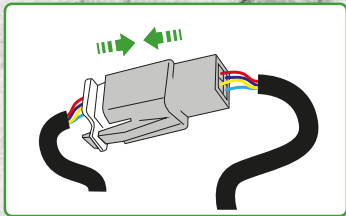
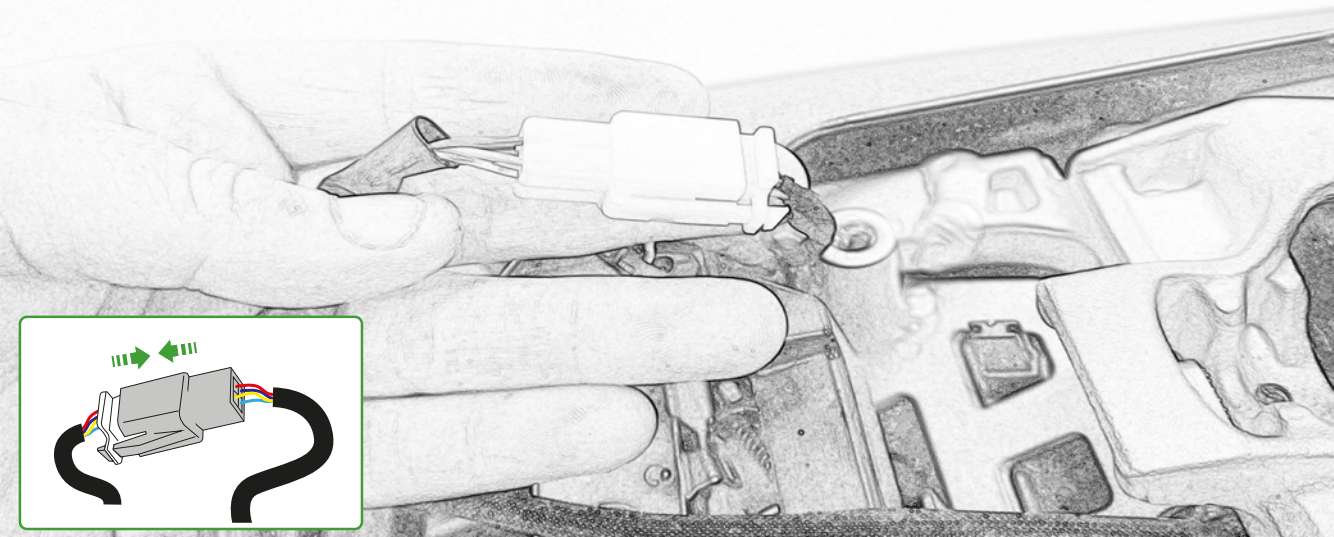

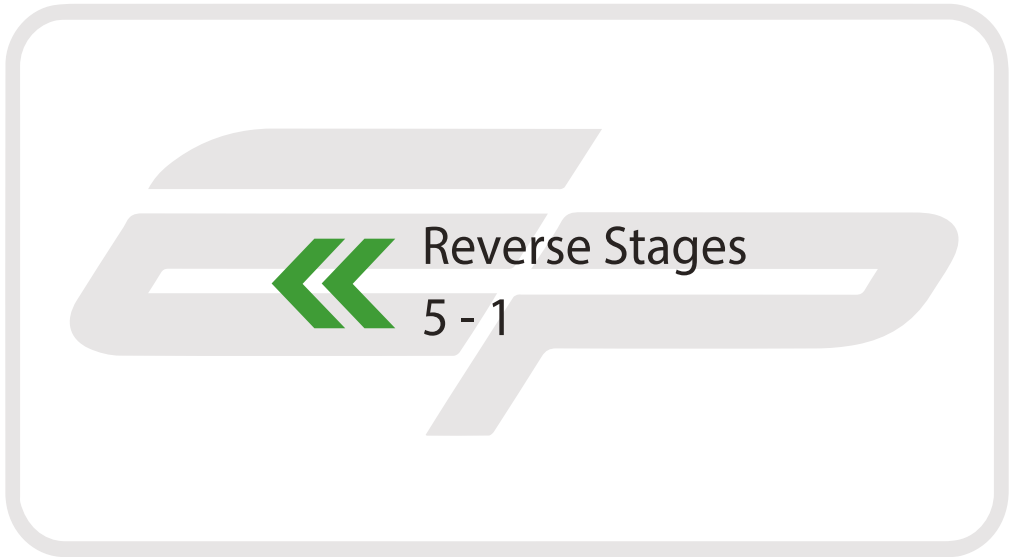



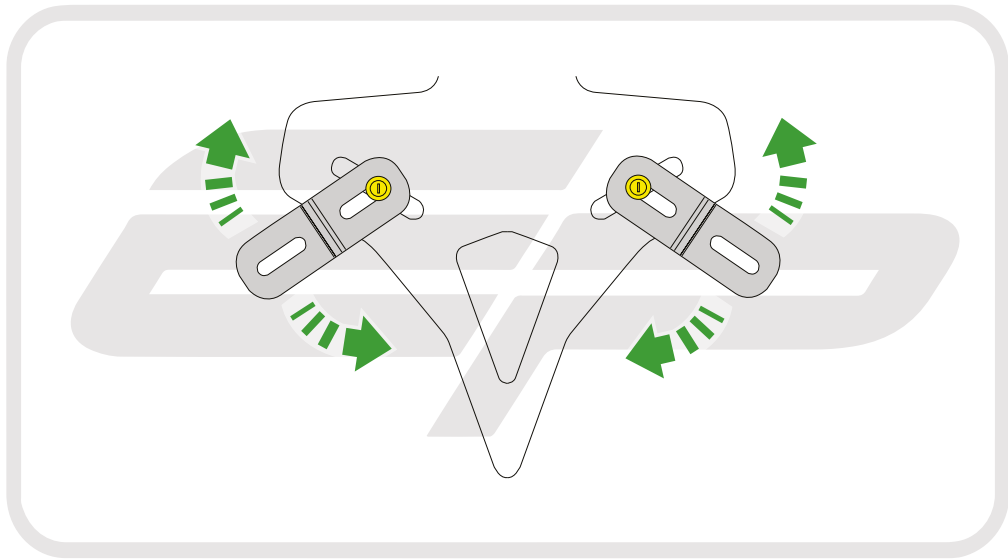

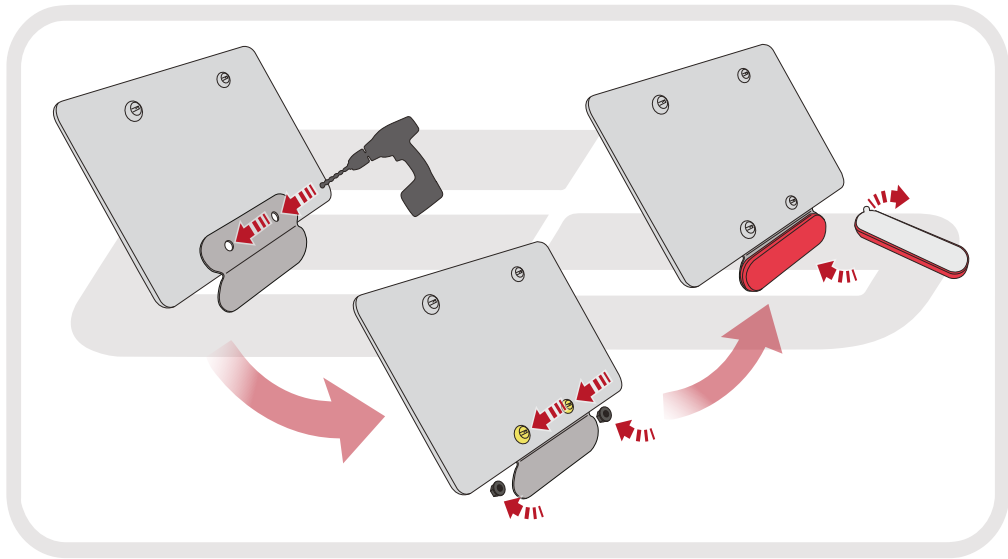



## ESSENTIAL CHECKS



After installation of your tail tidy ensure that the licence plate does not contact the rear tyre when suspension is fully compressed.

Ensure all electrics including indicators, tail light, brake light and licence plate light lights are working correctly before riding the motorcycle.

It is recommended that periodic inspections are made to ensure that all fixings are fully tightend.



**EVOTECH**®  
P E R F O R M A N C E

[www.evotech-performance.com](http://www.evotech-performance.com)