

**EVOTECH**®  
P E R F O R M A N C E

[www.evotech-performance.com](http://www.evotech-performance.com)

Suzuki V-Strom 1050

Crash Protection Instructions



## Kit Contents PRN015130

- Ⓐ 1 x Spindle Shaft
- Ⓑ 1 x Right Hand Spacer
- Ⓒ 1 x Left Hand Spacer
- Ⓓ 2 x Poly Washer
- Ⓔ 2 x M12 Nylock nut
- Ⓕ 2 x M12 Washer
- Ⓖ 2 x Bobbin Head

# Installation Instructions

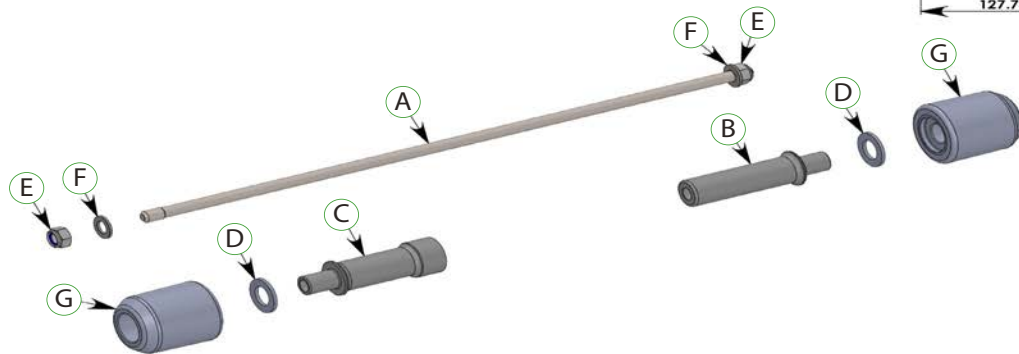
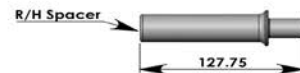
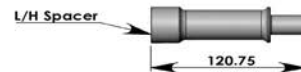

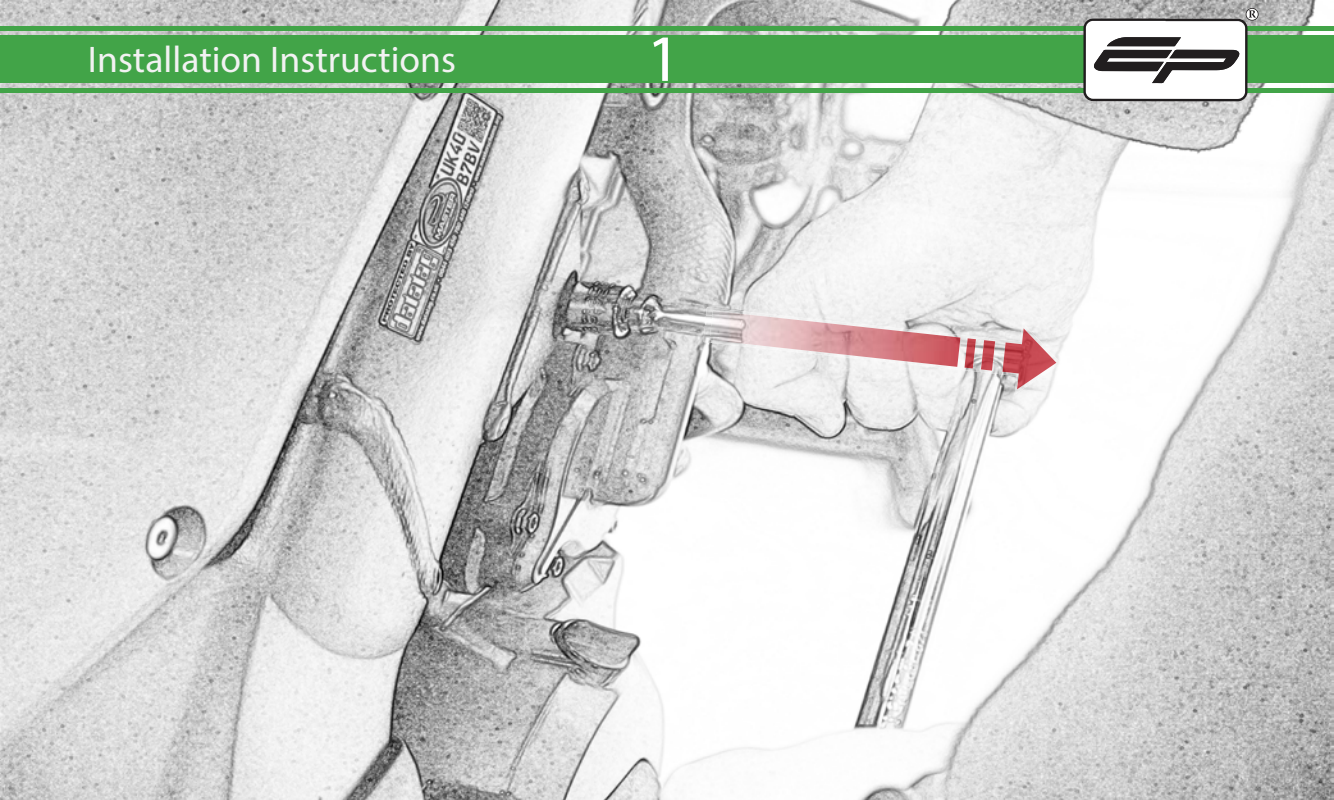



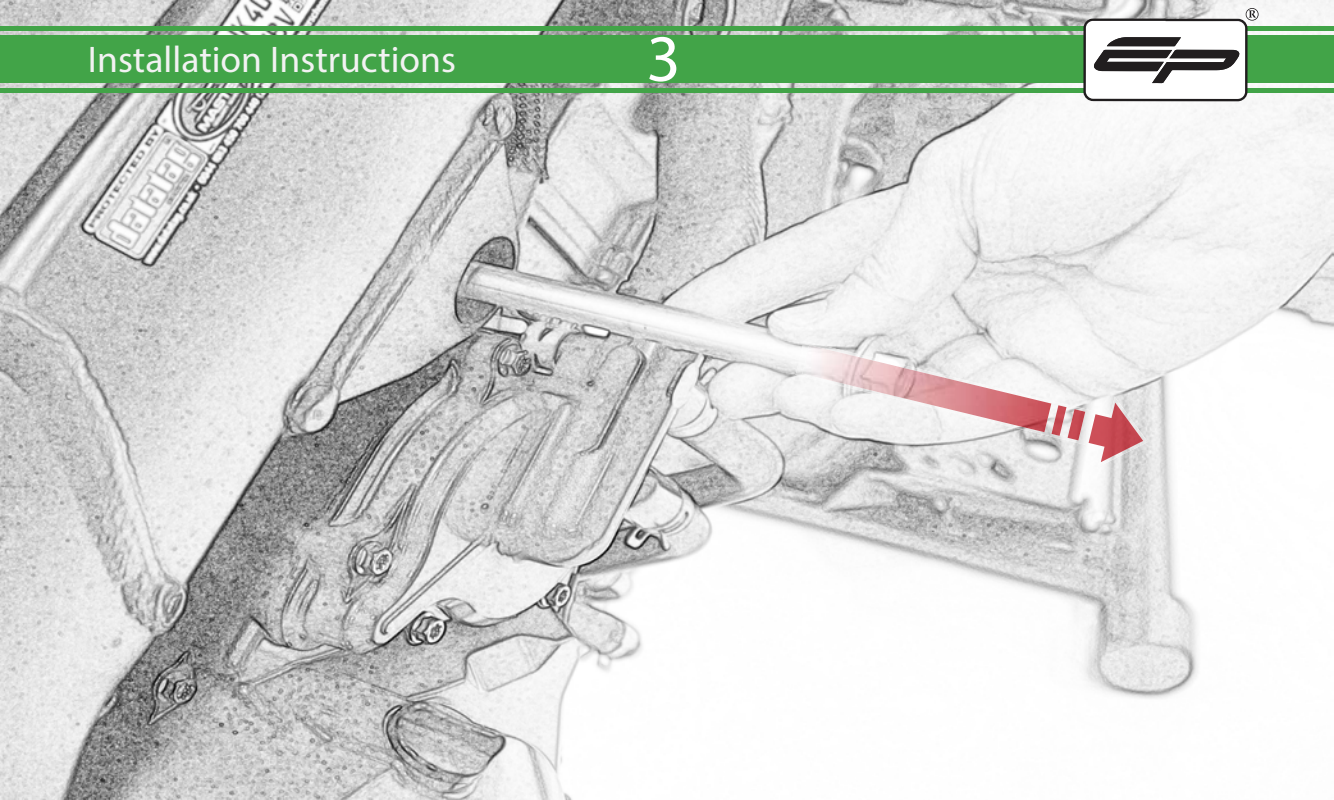

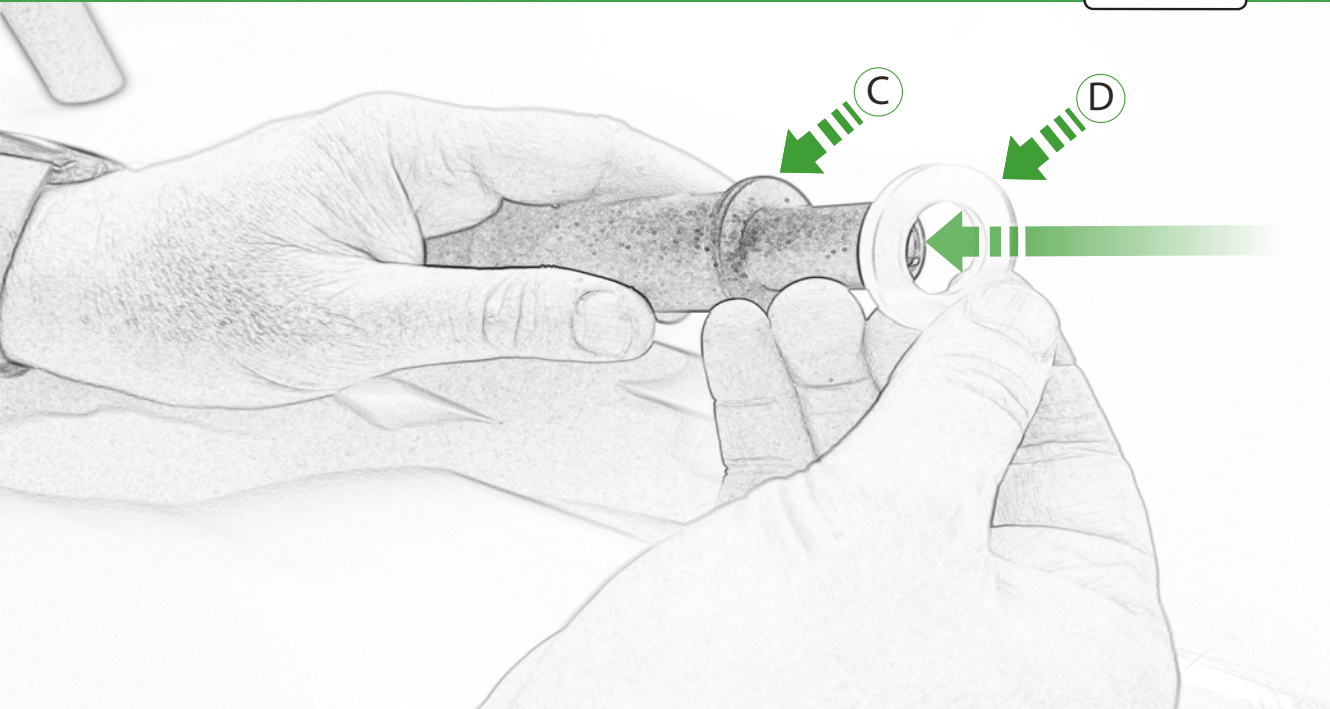







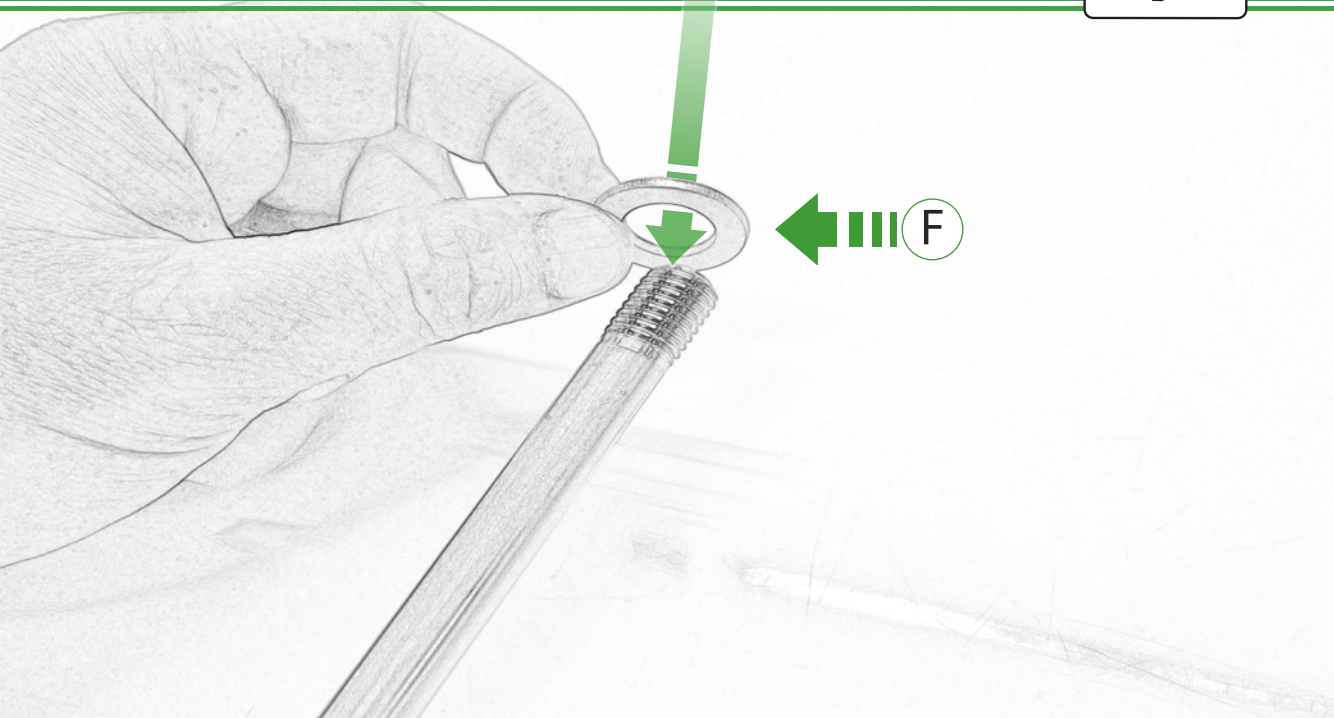

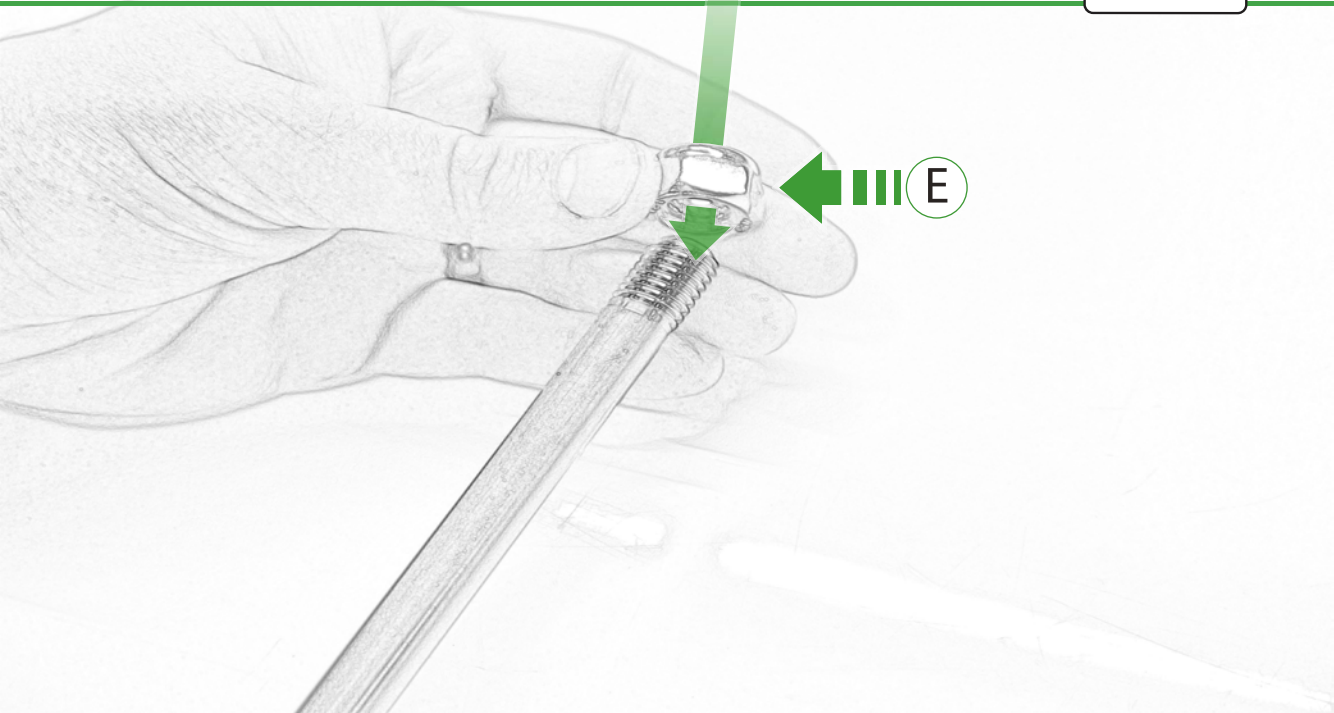

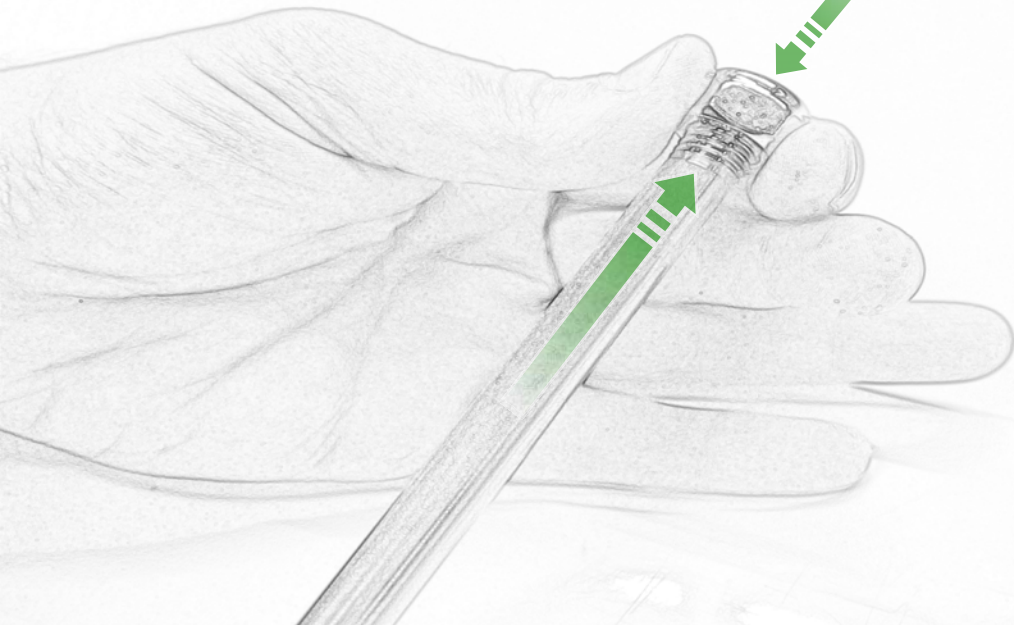

Do Not Fully Tighten

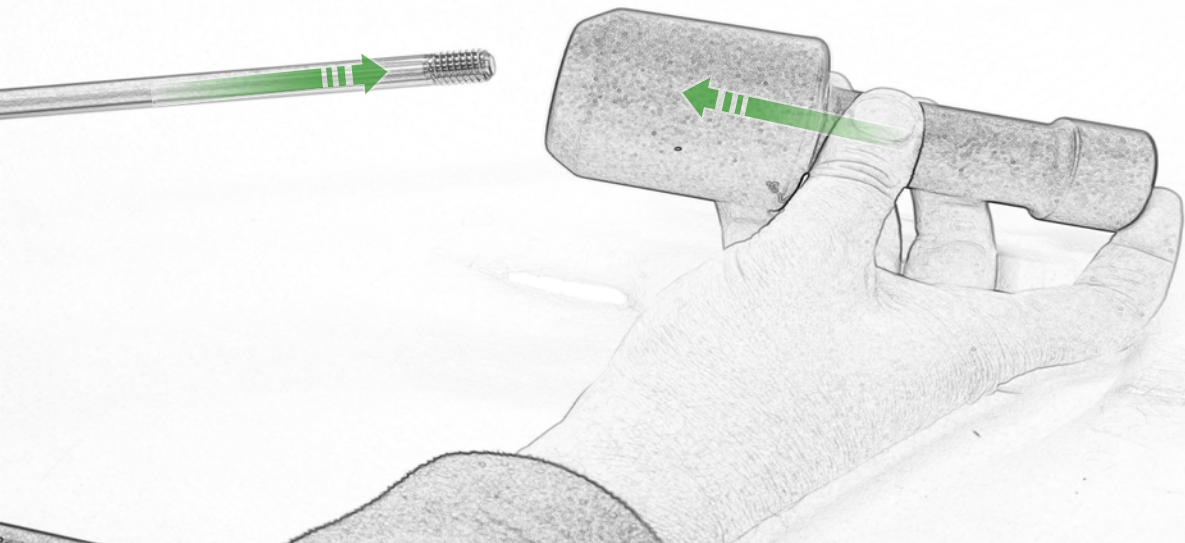

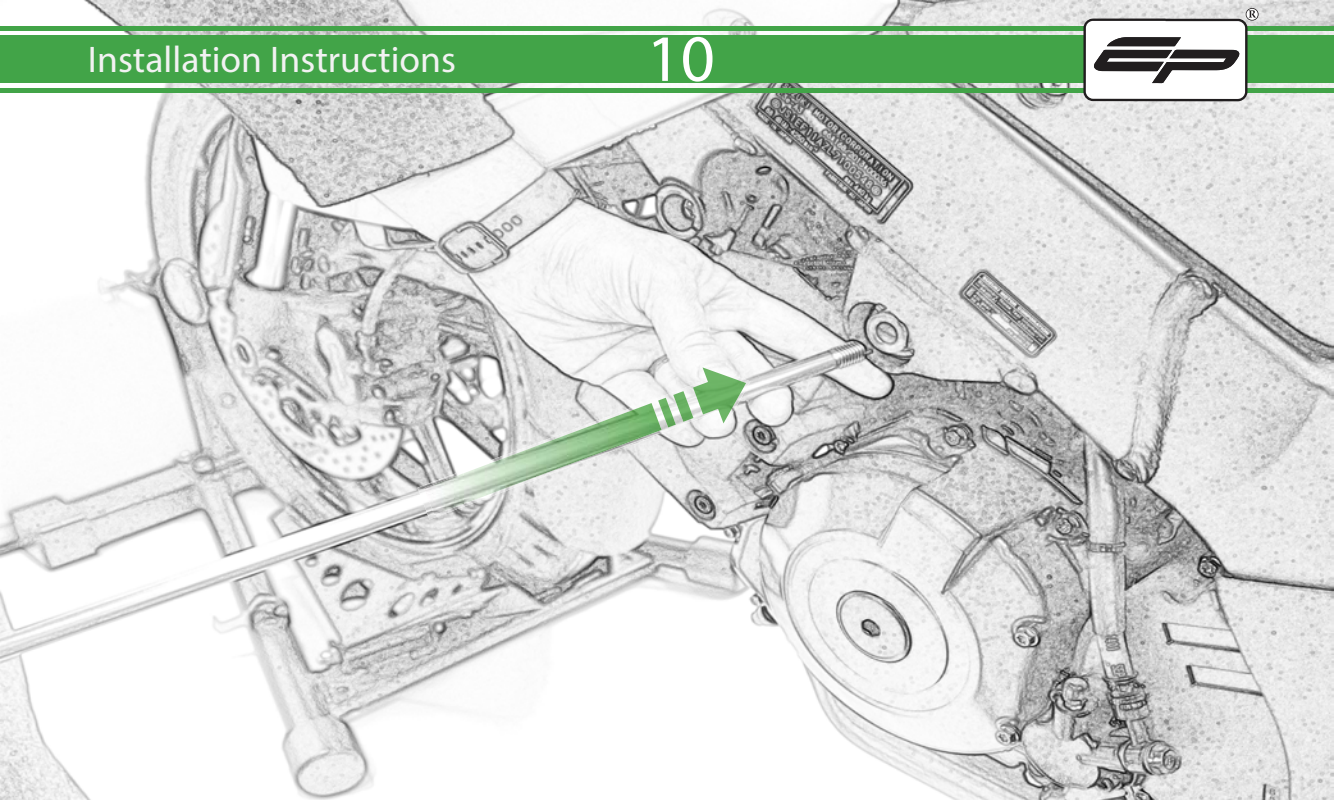



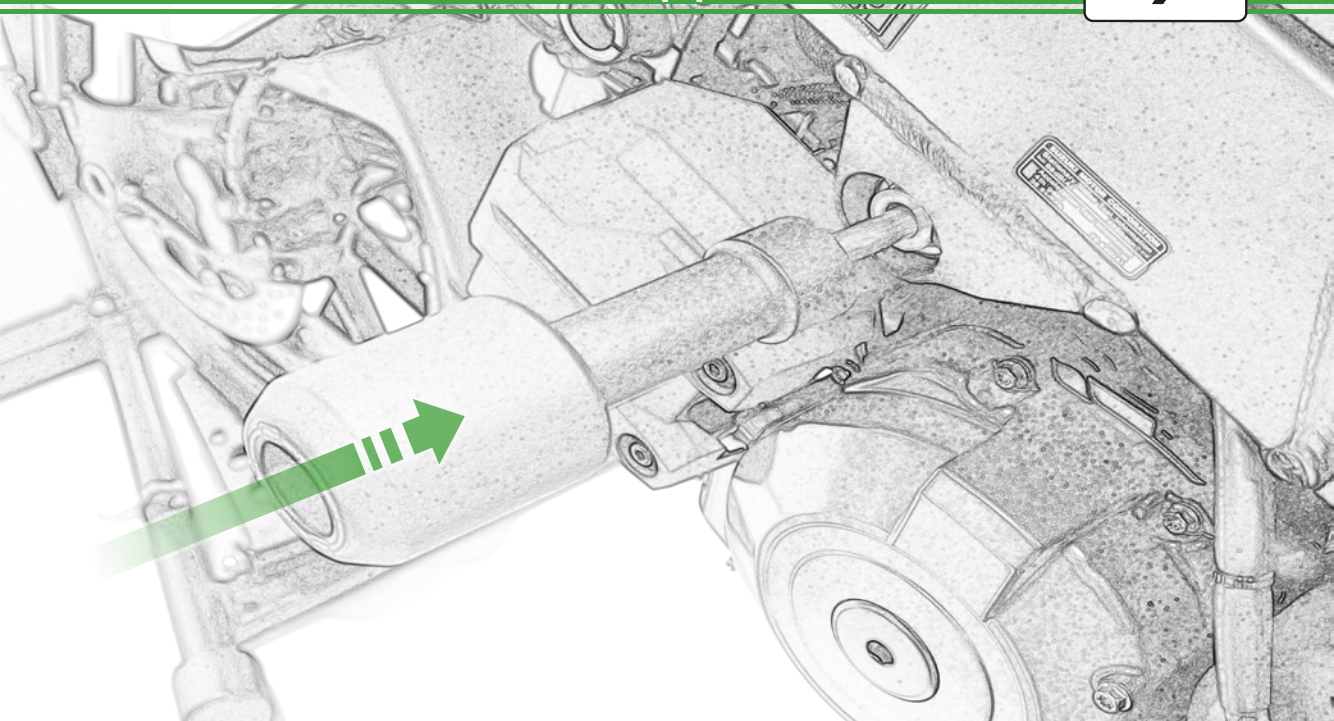

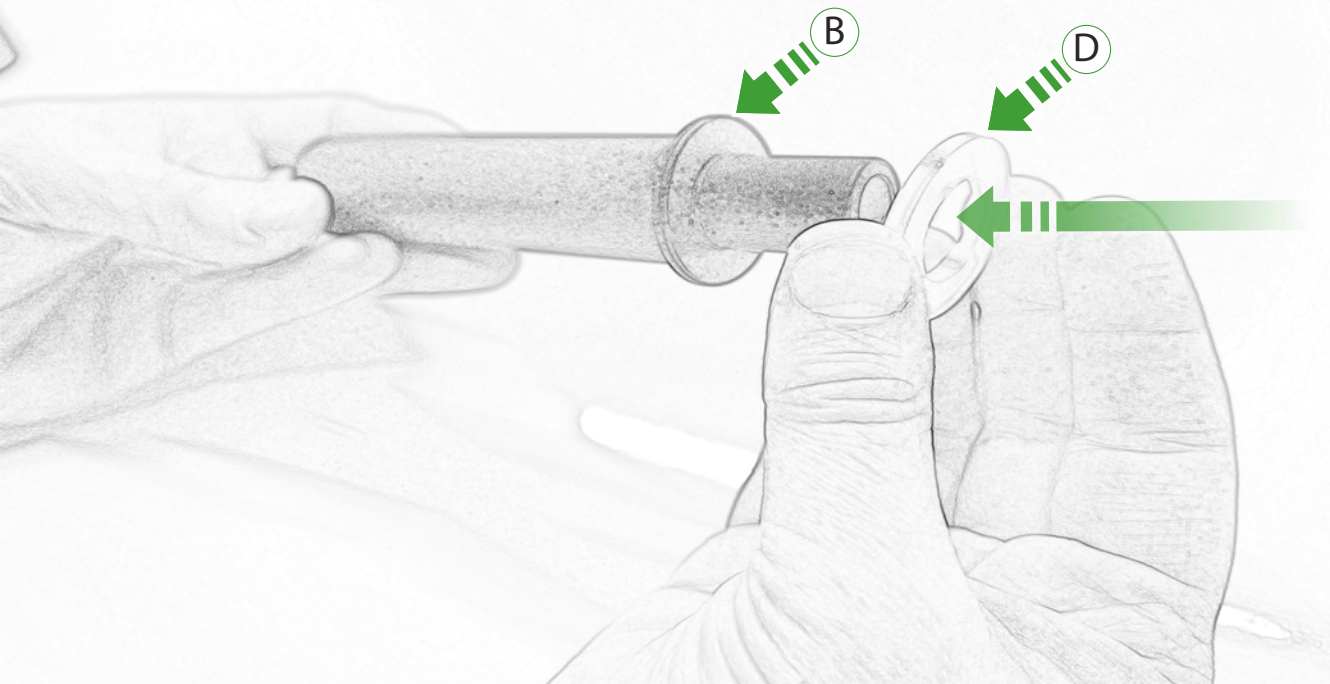



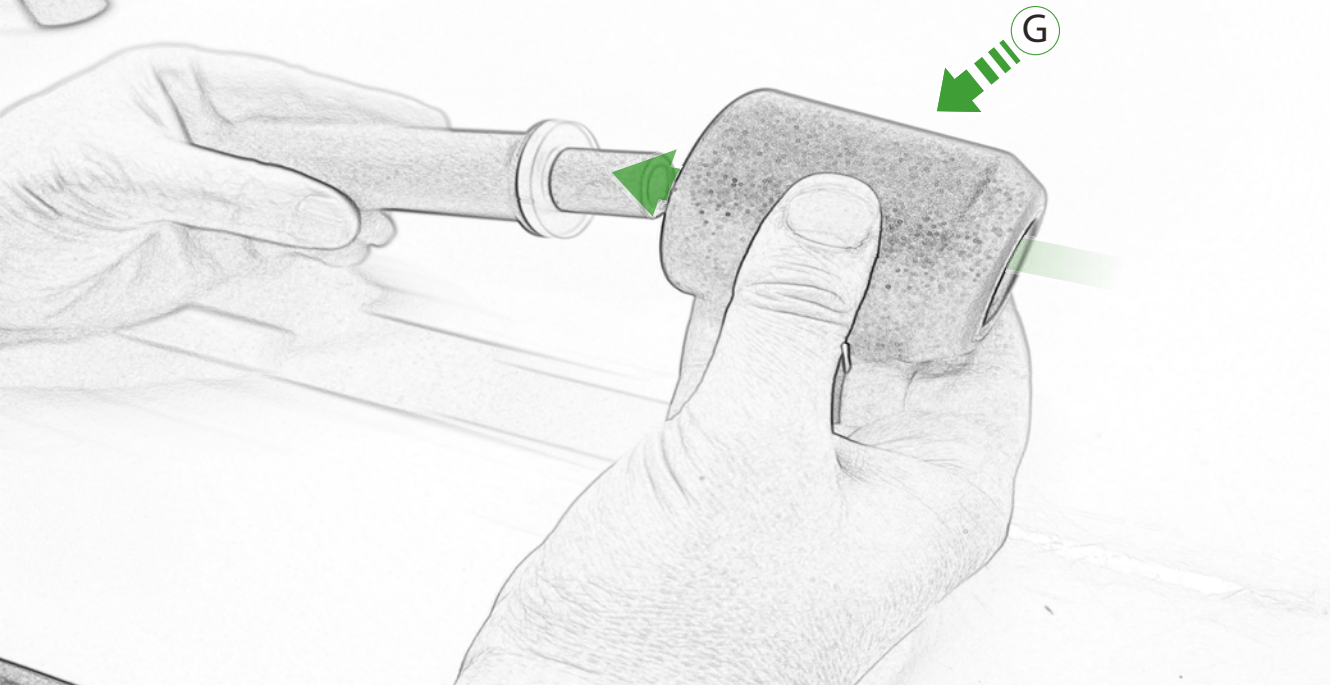

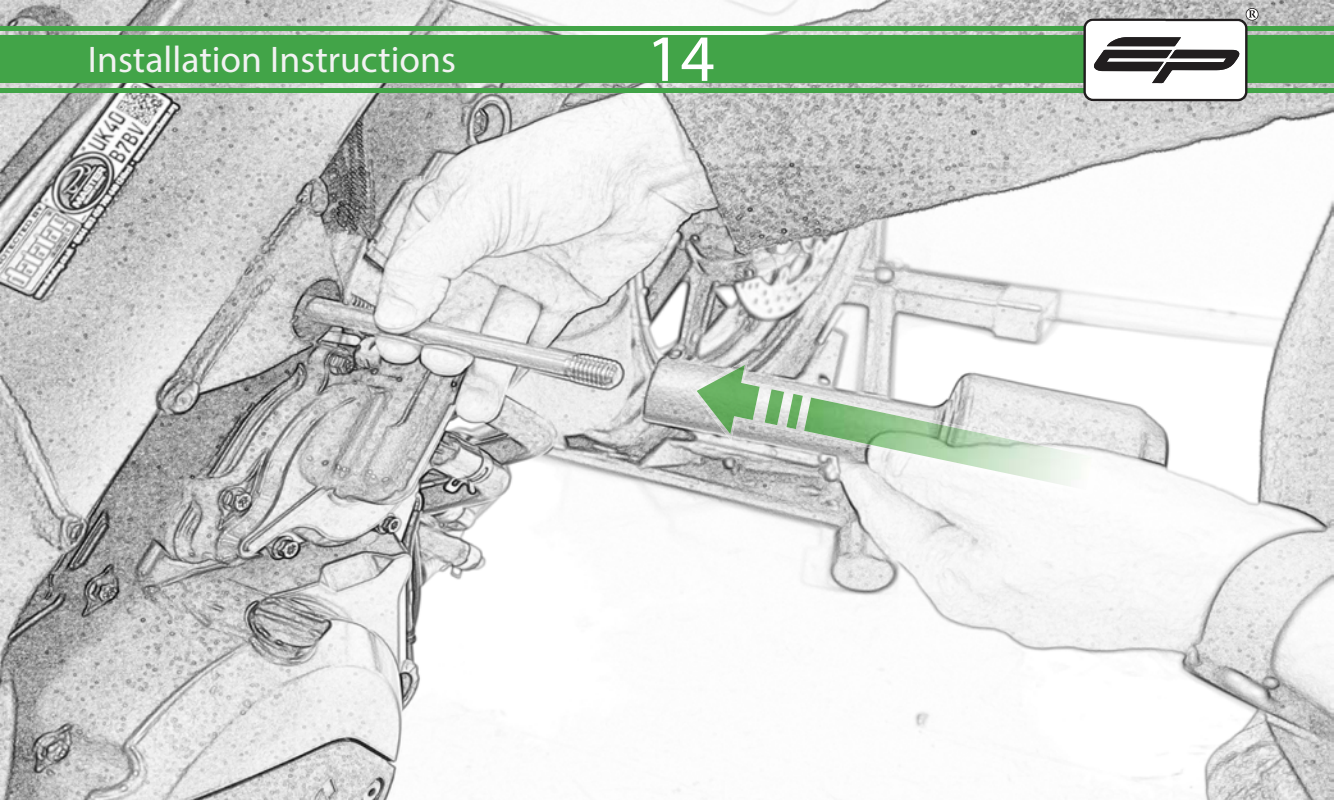

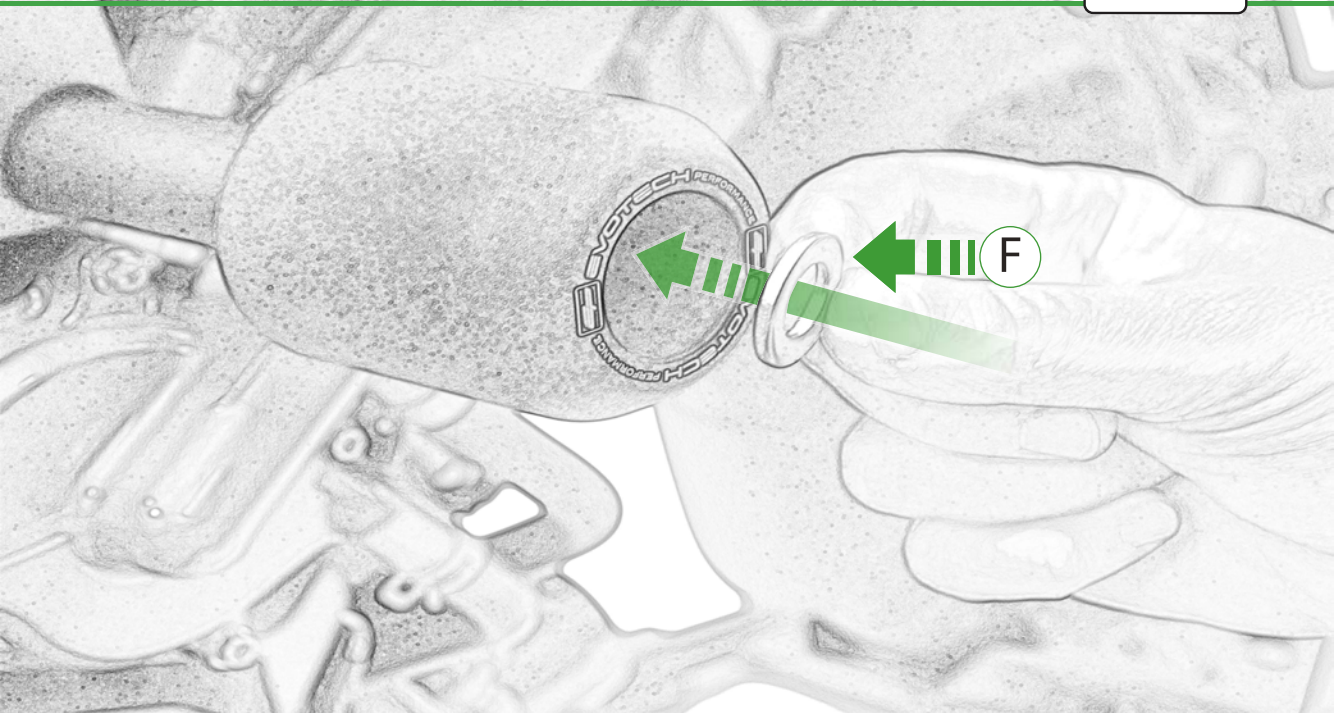

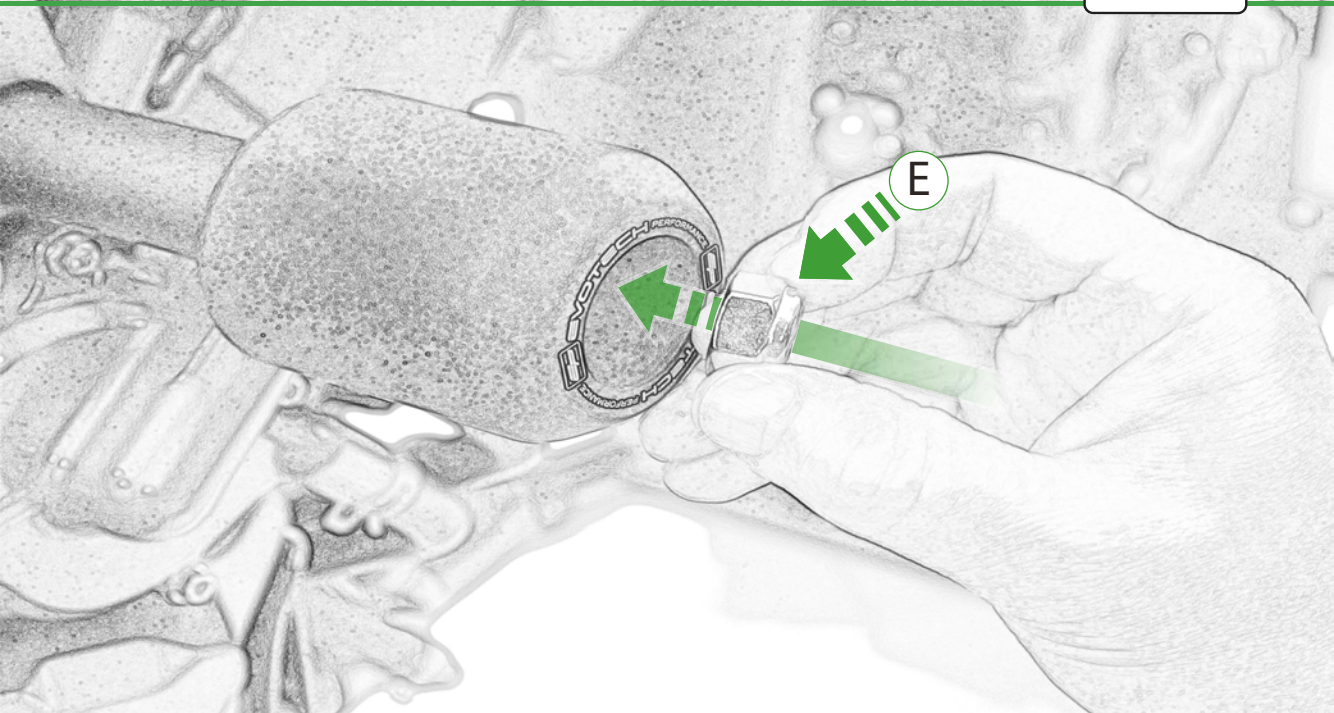



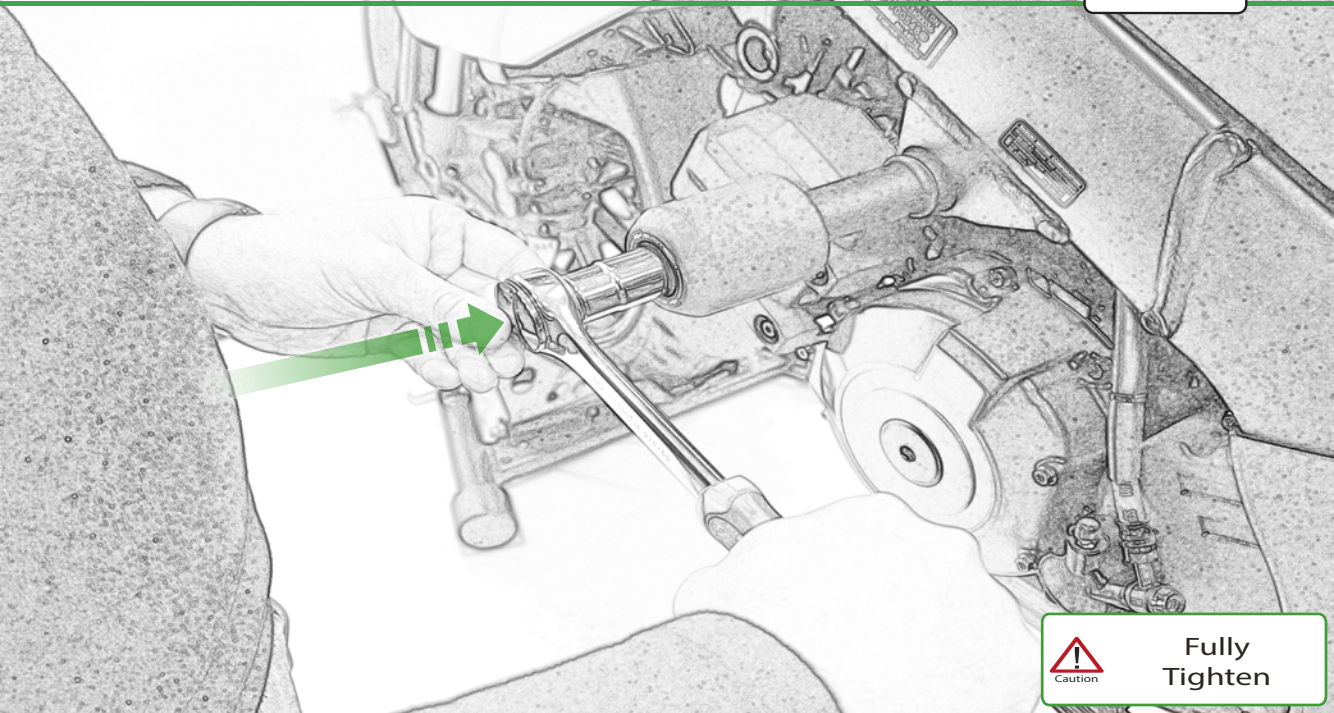

Fully  
Tighten

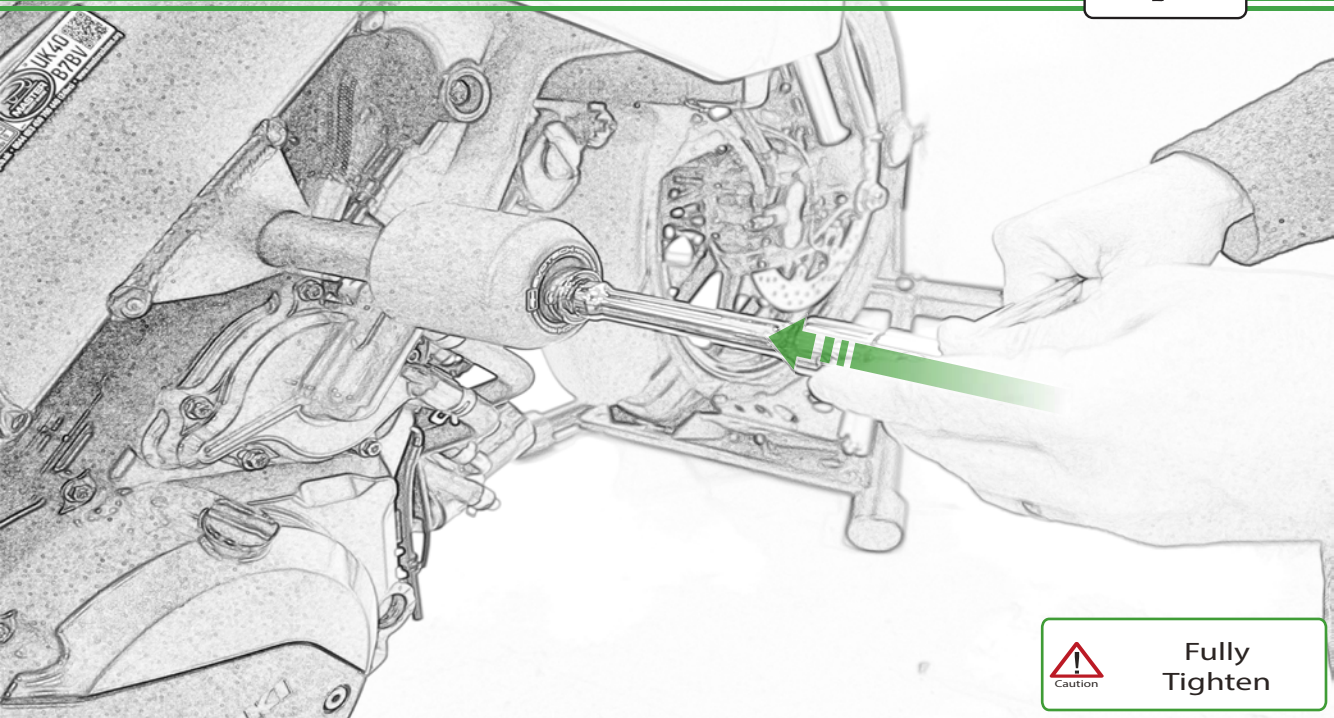

Fully  
Tighten



## ESSENTIAL CHECKS

It is recommended that periodic inspections are made to ensure that all bolts are tightened to the specified torque settings.

Should the bike be involved in an accident a thorough inspection should be made and any components that have taken an impact, no matter how small, be replaced





**EVOTECH**®  
P E R F O R M A N C E

[www.evotech-performance.com](http://www.evotech-performance.com)