



EVOTECH[®]
P E R F O R M A N C E

BMW S1000R

Crash protection

Installation Instructions



Kit Contents PRN013782

- | | |
|-------------------------------------------|------------------------------------|
| A 1 x L/H Bracket | I 1 x Main Shaft |
| B 1 x R/H Inner Bracket | J 2 x M10 x 60 Caphead Bolt |
| C 1 x R/H Outer Bracket | K 2 x M12 Washers |
| D 1 x L/H Bobbin Spacer | L 2 x Polyurathane Washer |
| E 1 x R/H Bobbin Spacer | M 2 x Bobbin Heads |
| F 1 x Concial Spacer | N 2 x M8 x 25 Caphead Bolt |
| G 1 x M12 x 60 x 1.25 Caphead Bolt | |
| H 1 x M12 x 85 x 1.25 Caphead Bolt | |

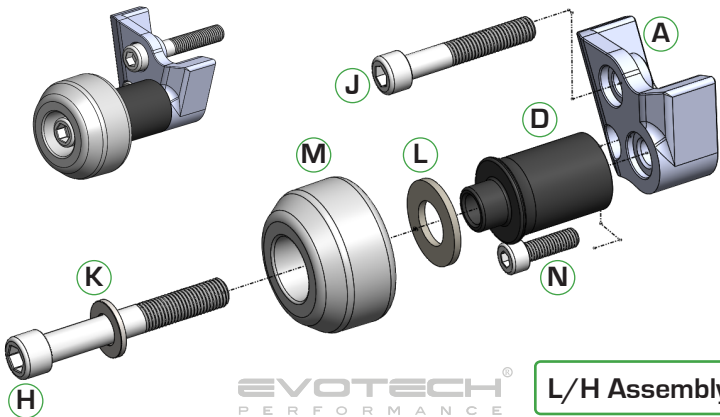

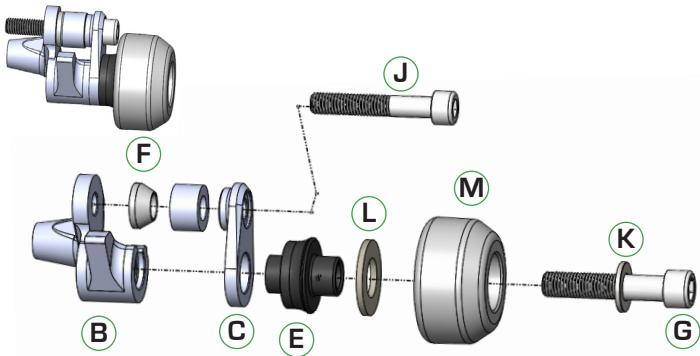

EVOTECH[®]
P E R F O R M A N C E

R/H Assembly

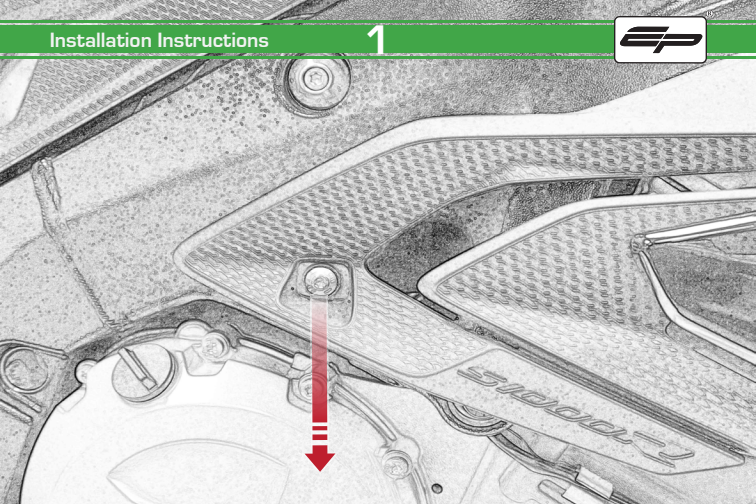

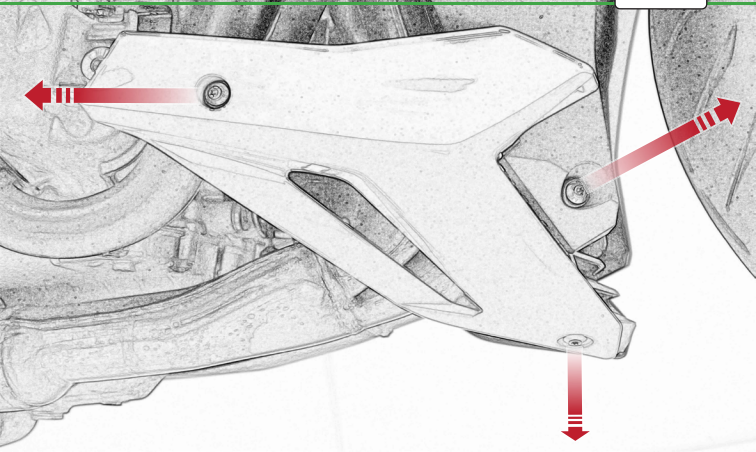

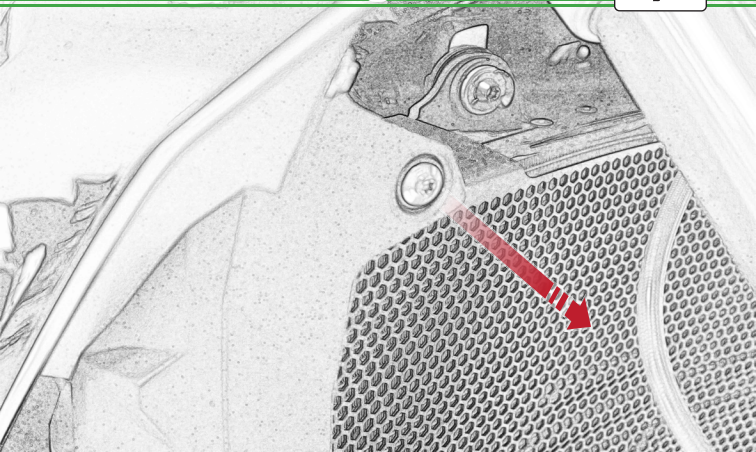

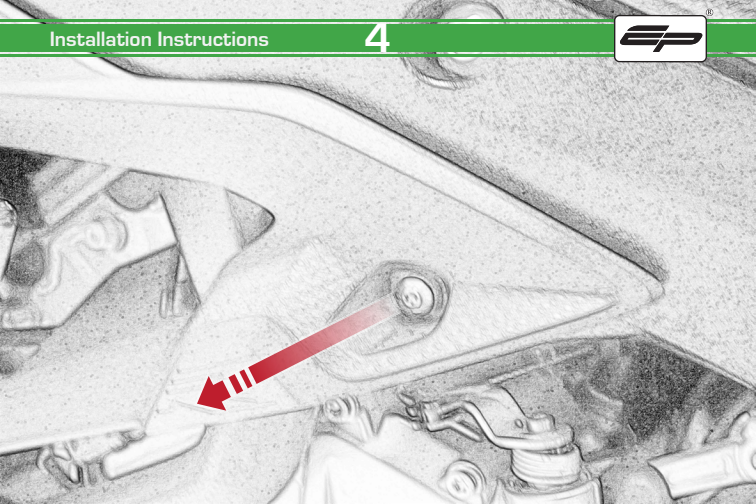

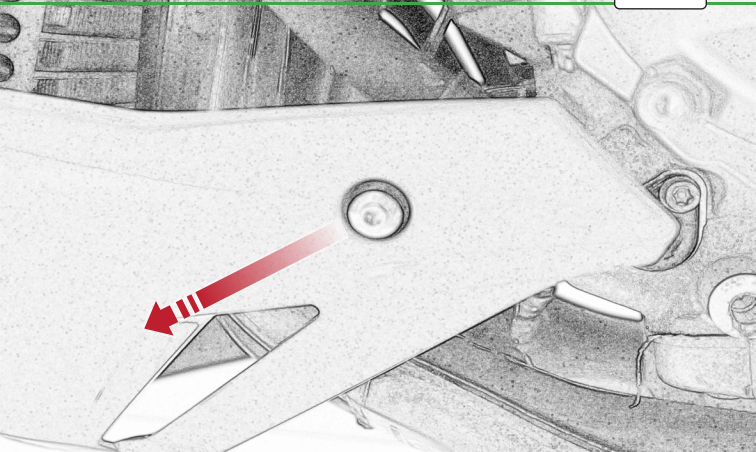

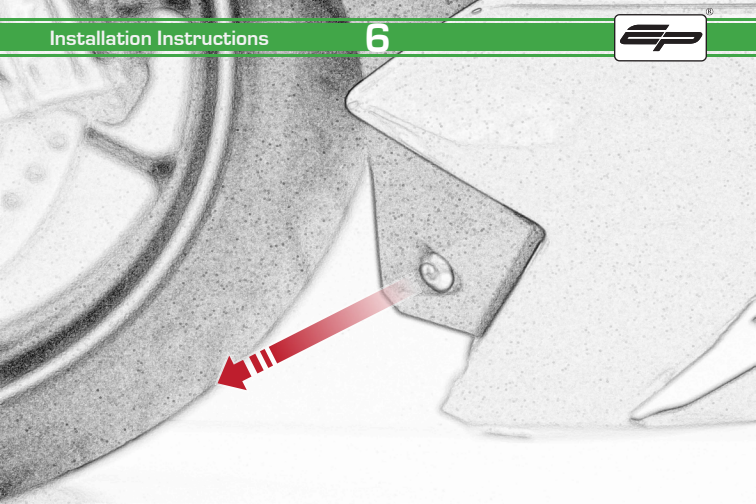

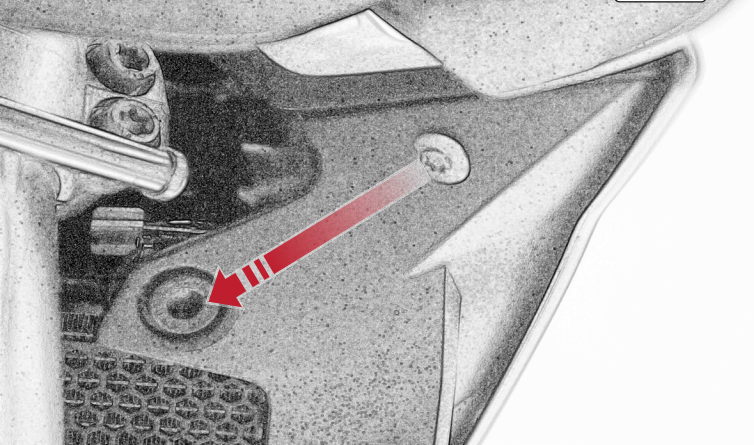

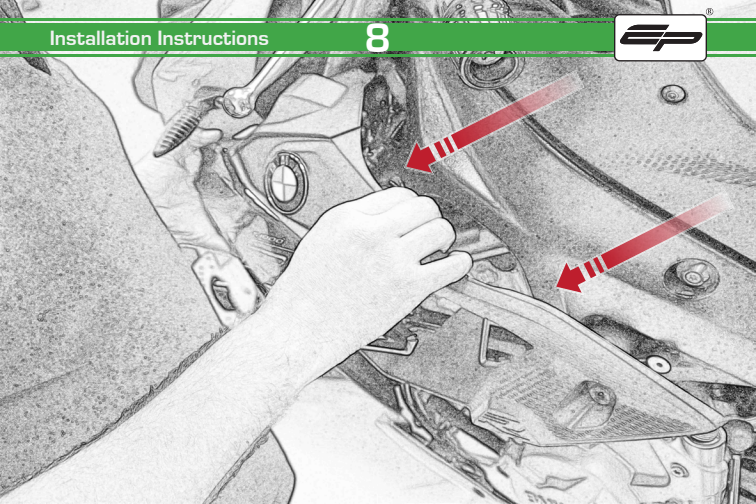

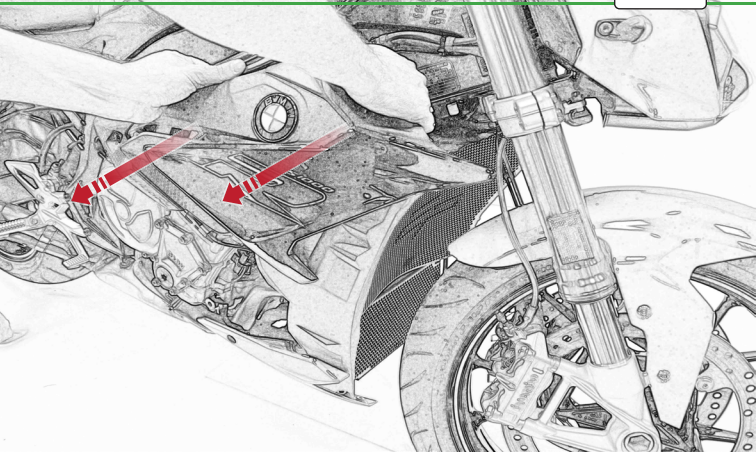

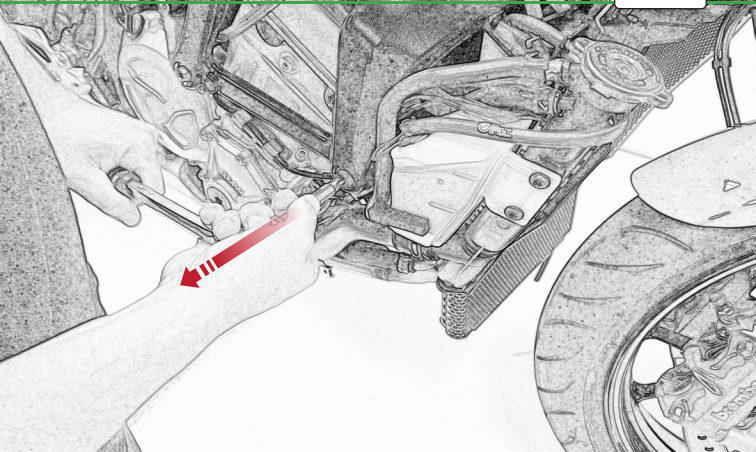

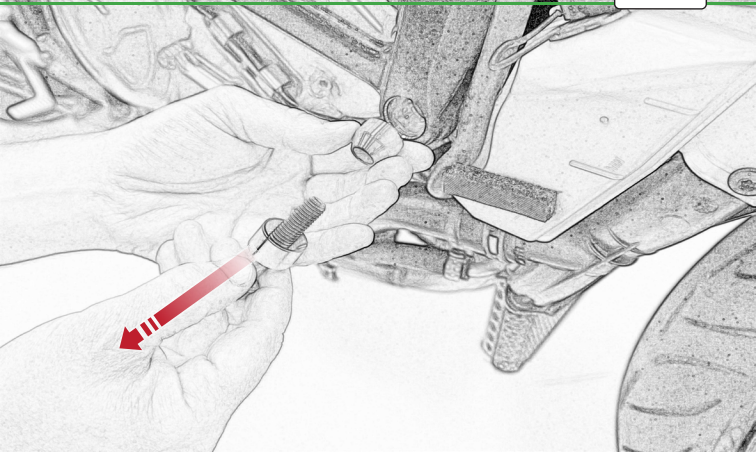

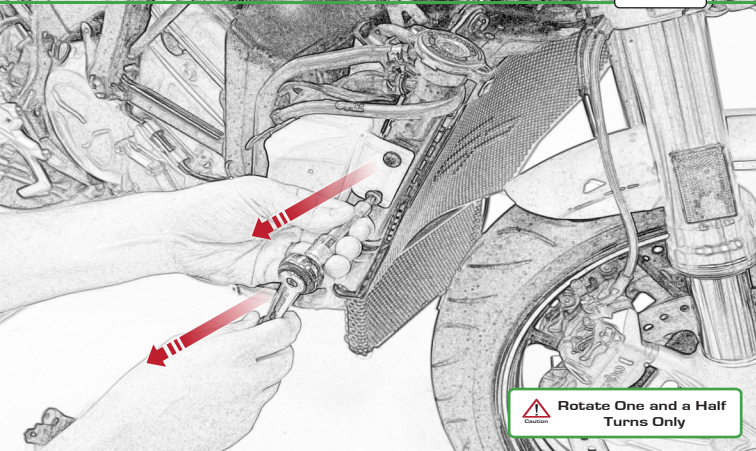

**Rotate One and a Half
Turns Only**

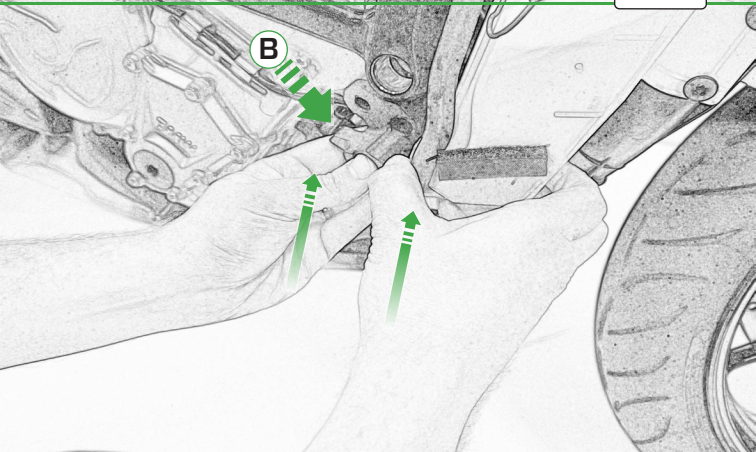

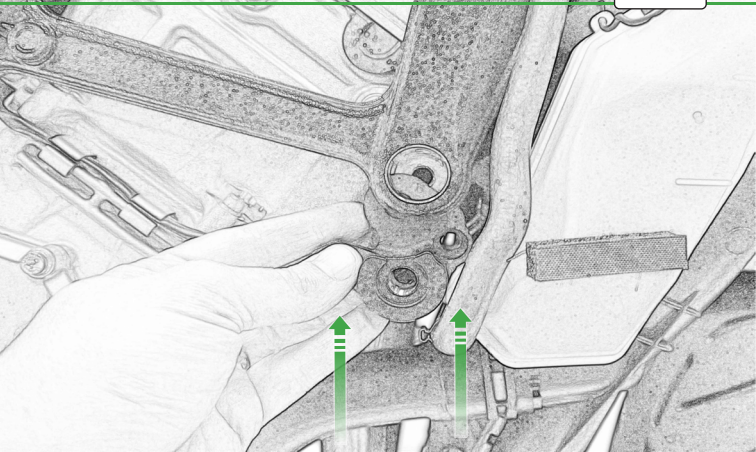

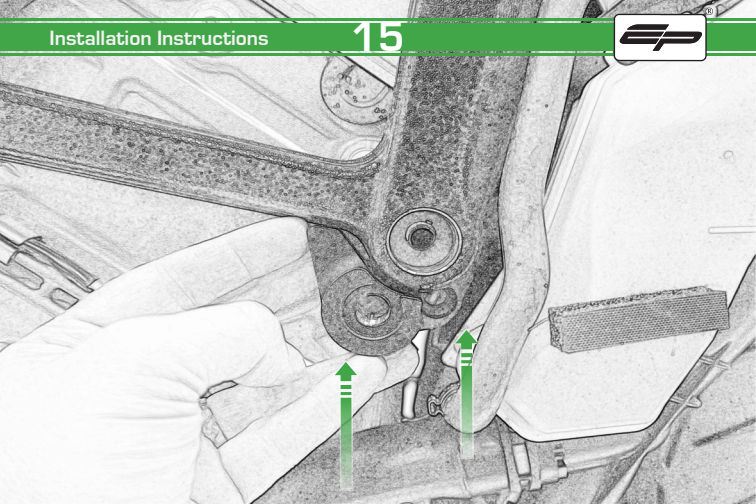

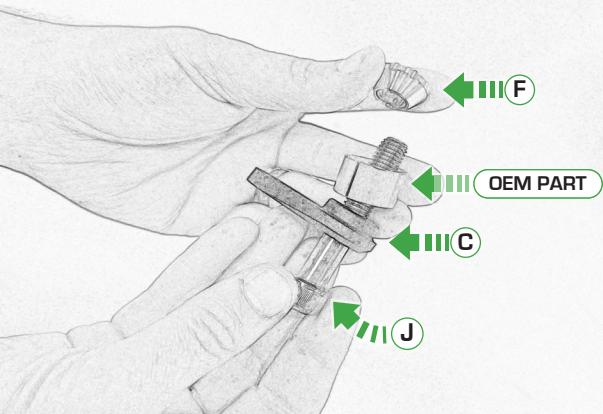



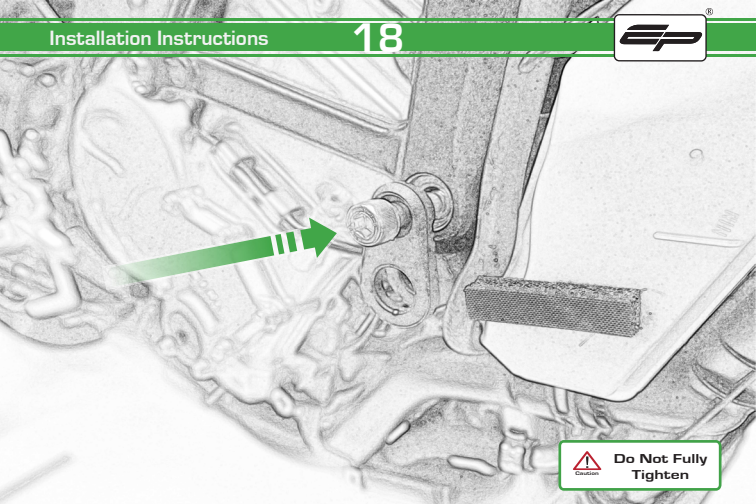

**Do Not Fully
Tighten**

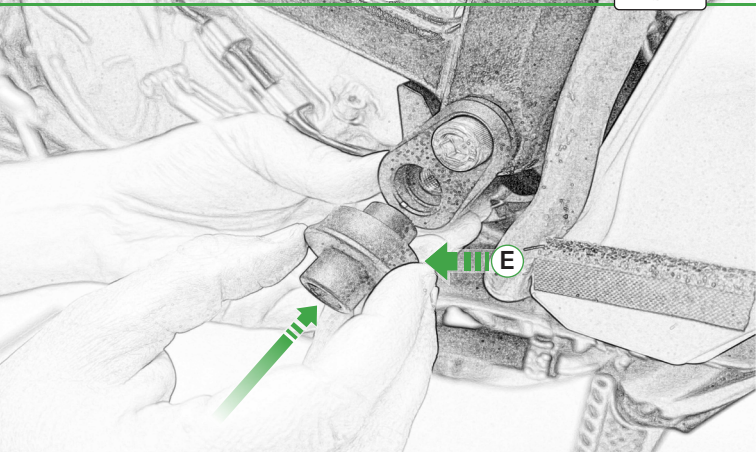

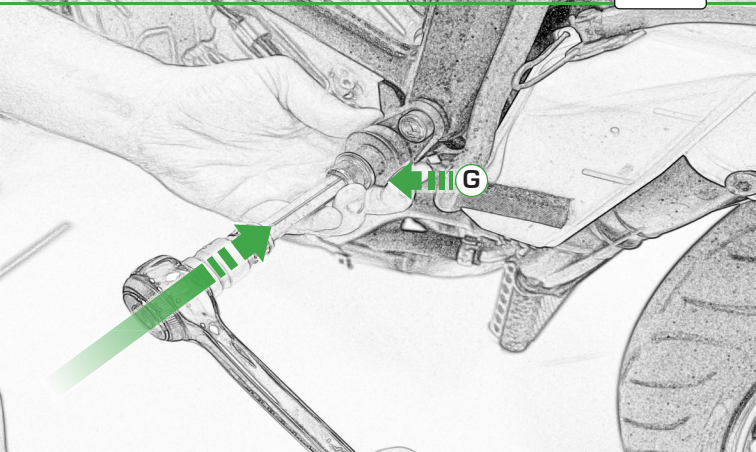

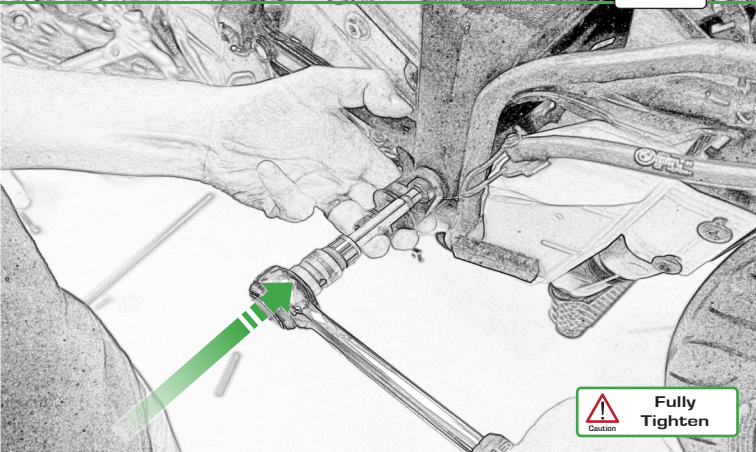

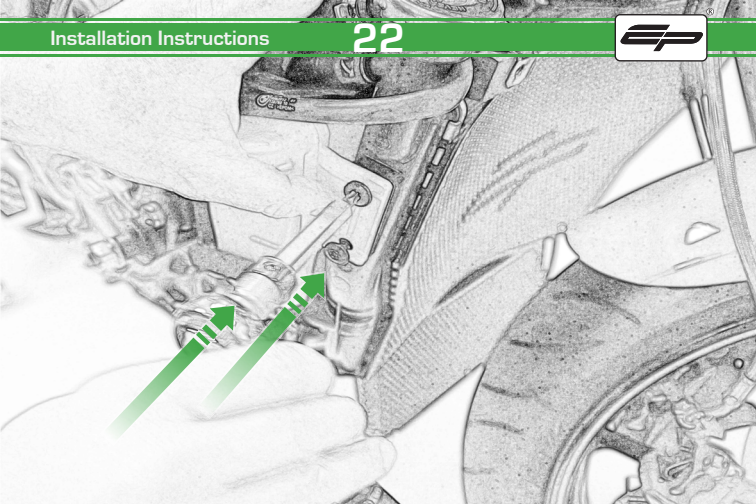

Caution

**Fully
Tighten**

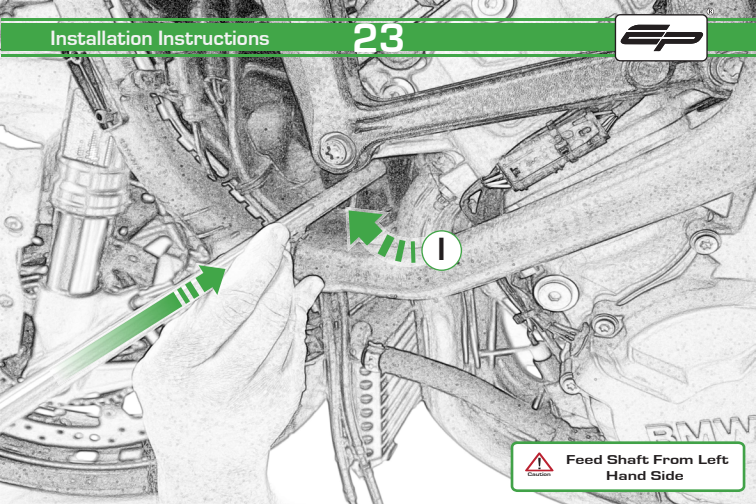



 **Feed Shaft From Left Hand Side**



Caution

**Locate Shaft in
Right Hand Bracket**

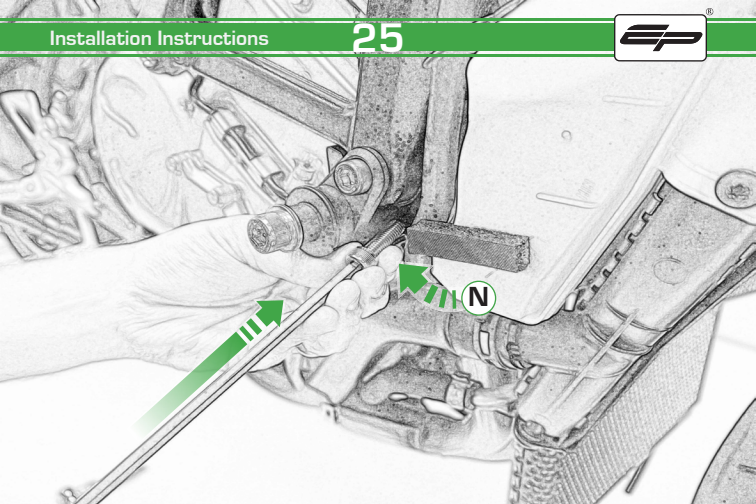

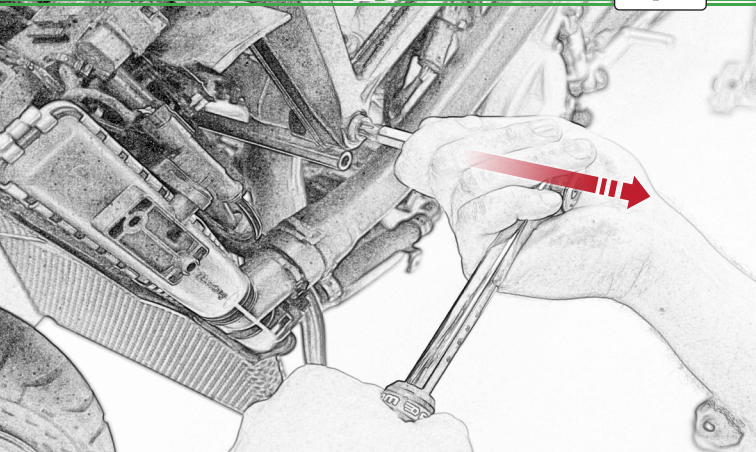

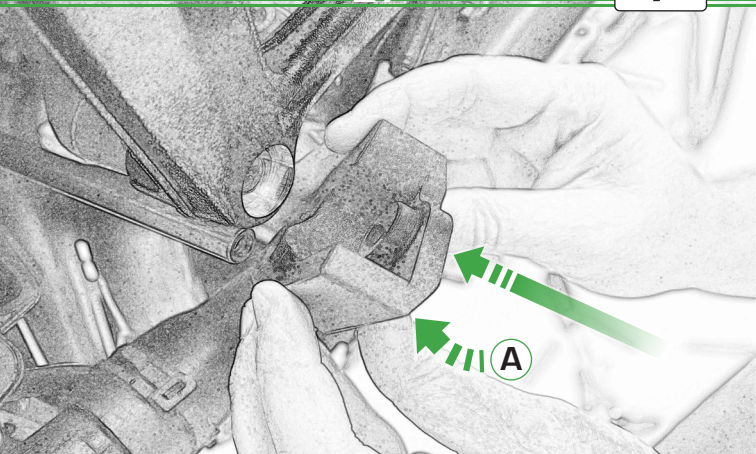

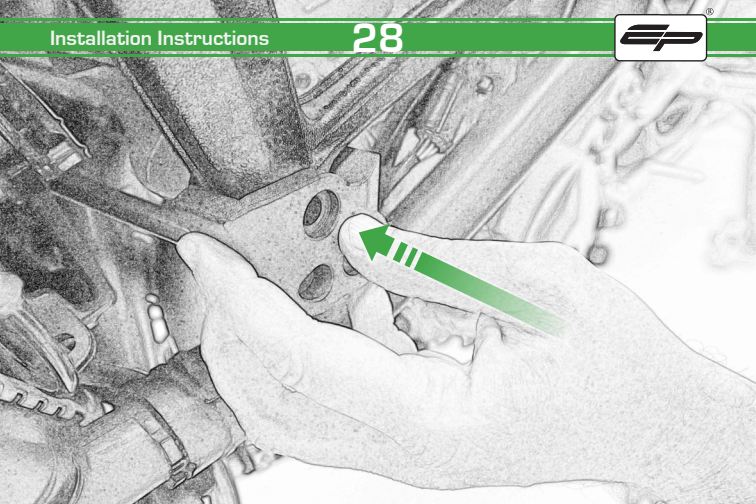

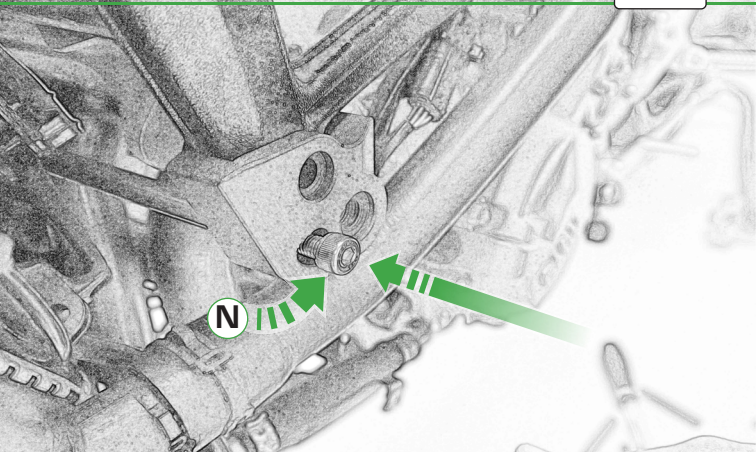

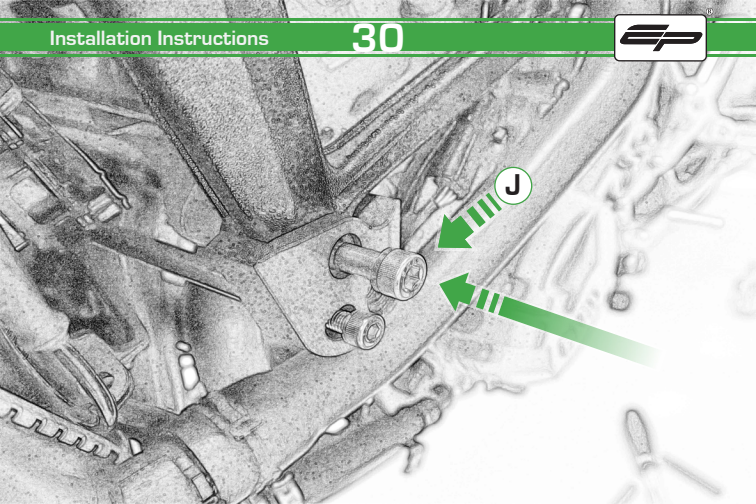

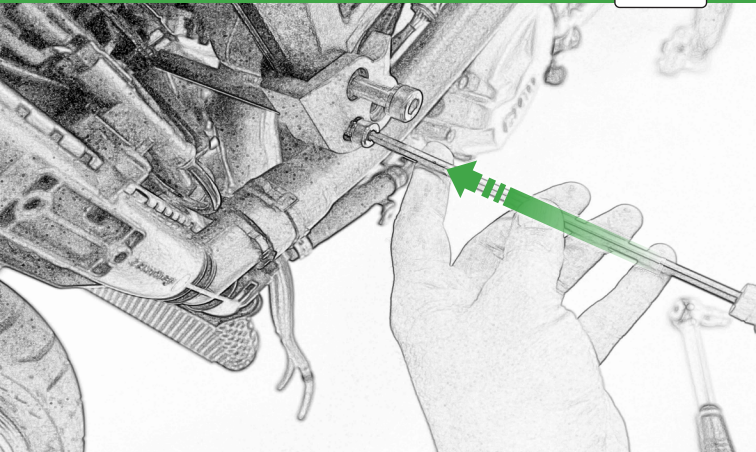

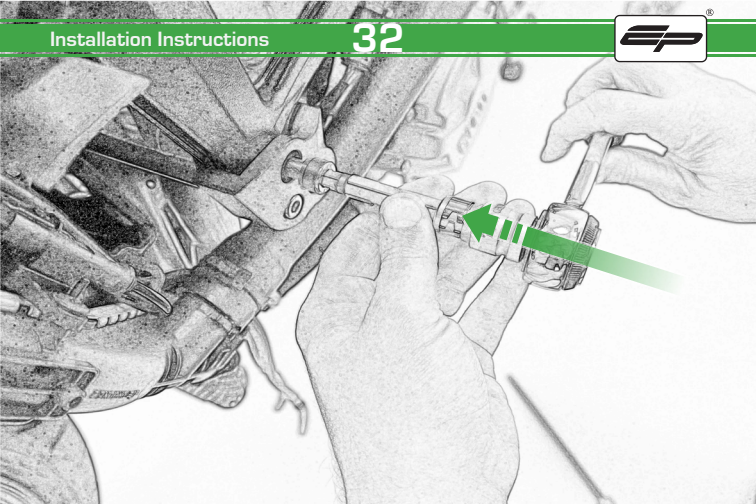

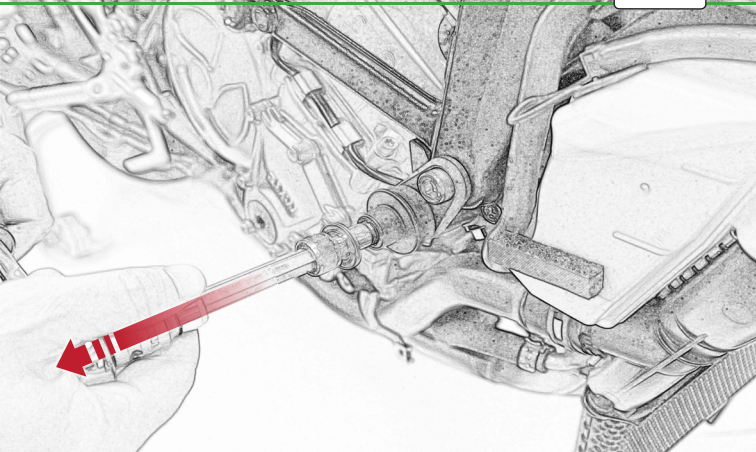

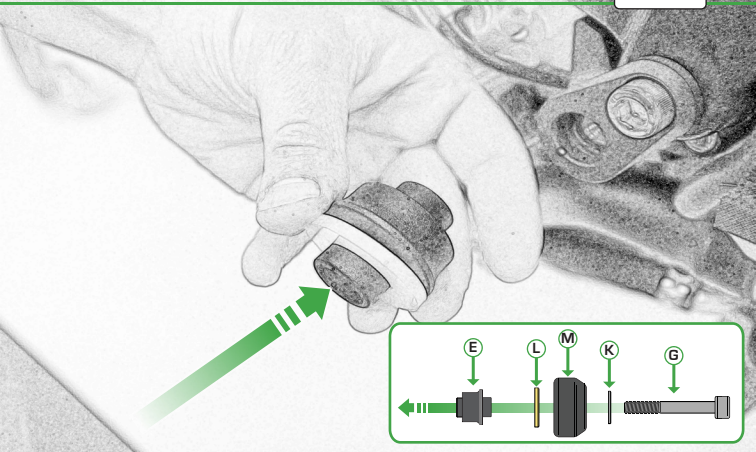

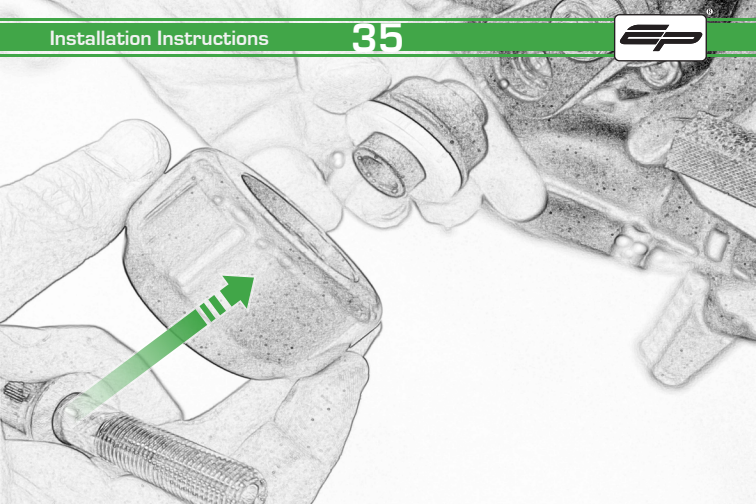

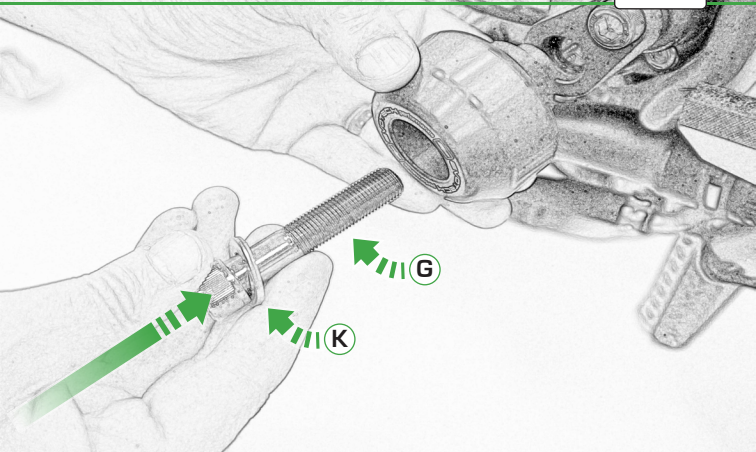

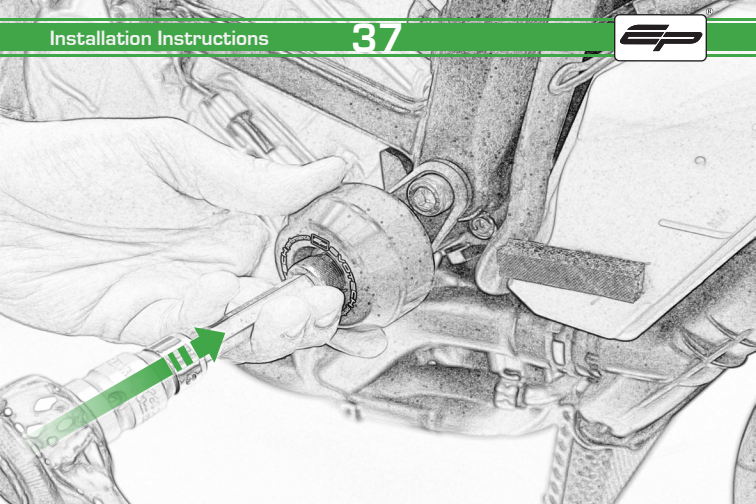

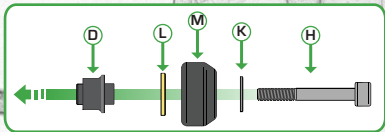
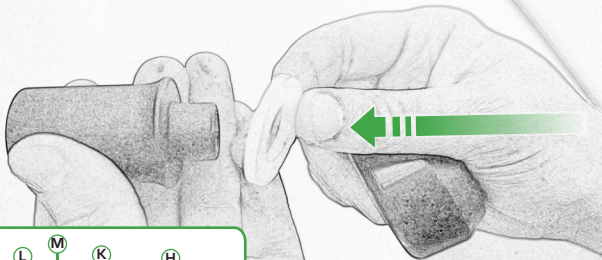

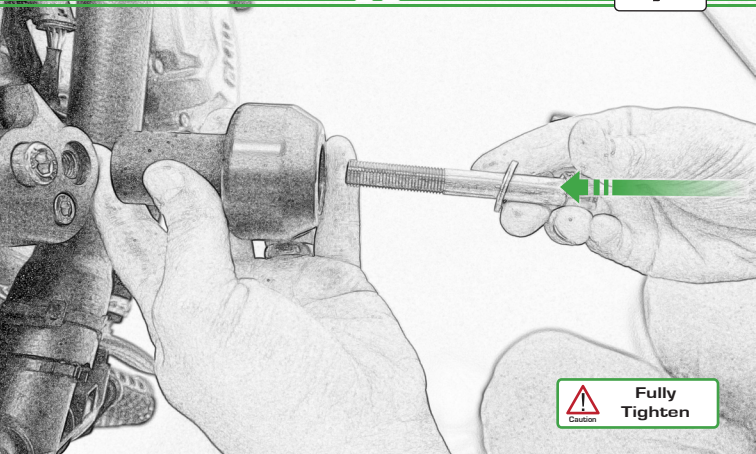

 **Fully Tighten**
Caution



Reverse Stages

9 - 1

 **ESSENTIAL CHECKS** 

It is recommended that periodic inspections are made to ensure that all bolts are tightened to the specified torque settings.

Should the bike be involved in an accident a thorough inspection should be made and any components that have taken an impact, no matter how small, be replaced



EVOTECH®
P E R F O R M A N C E

www.evotech-performance.com