



EVOTECH[®]
P E R F O R M A N C E

Ducati Scrambler
Engine Guard

Installation Instructions



Kit Contents PRN014118

- (A) 1 x Upper Bracket
- (B) 1 x Lower Bracket
- (C) 5 x M6 x 12mm Black Button Head Bolts

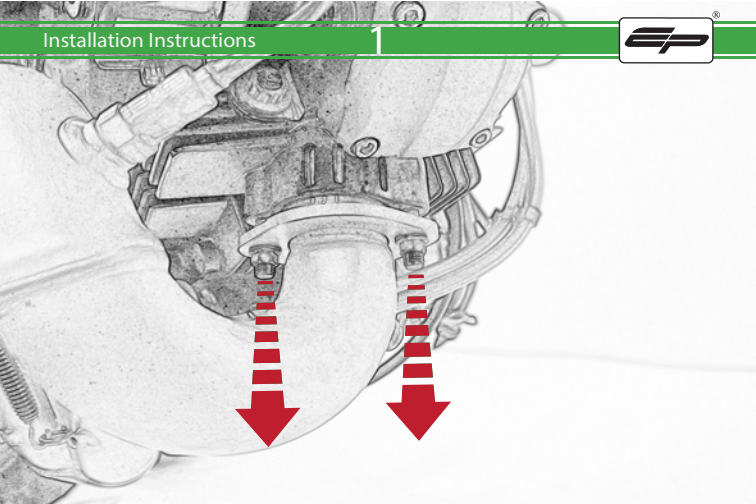

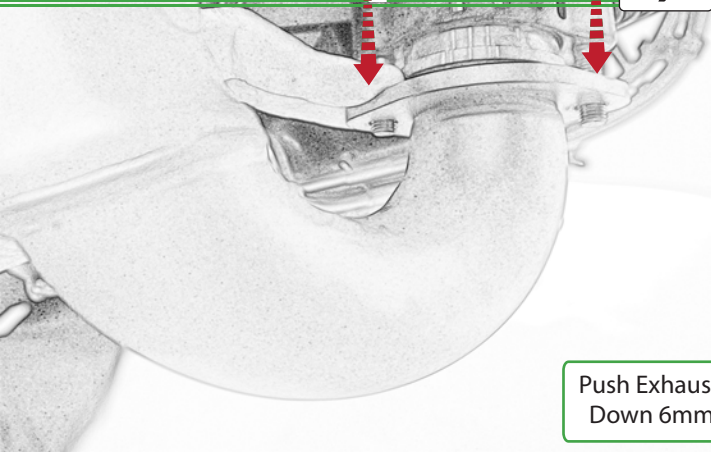

Push Exhaust
Down 6mm

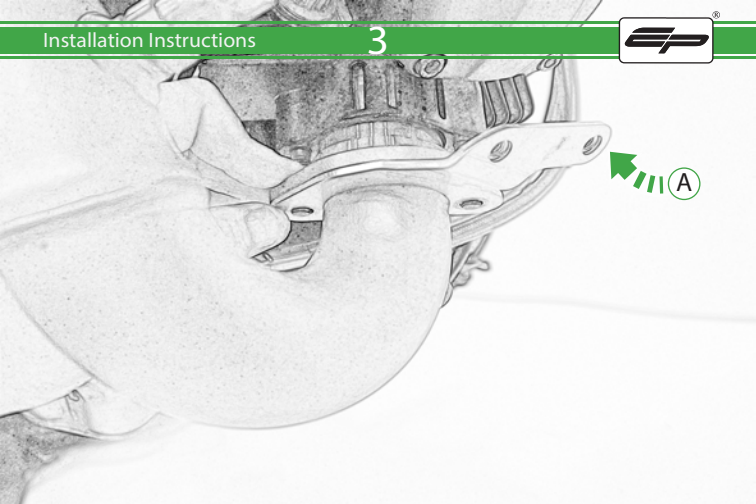

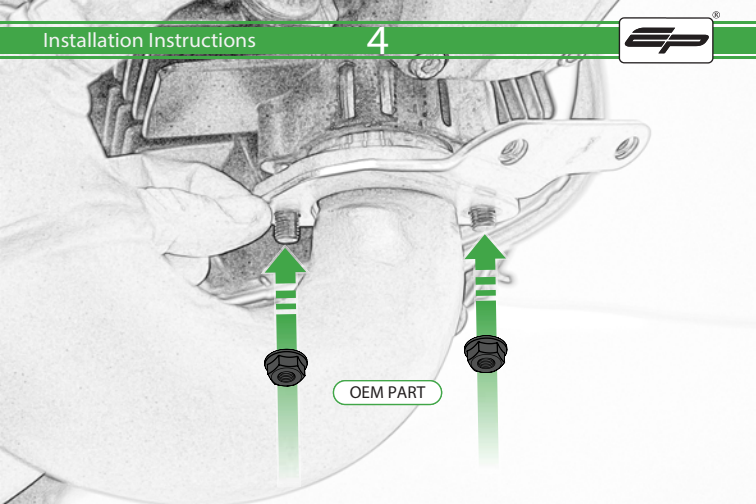

OEM PART

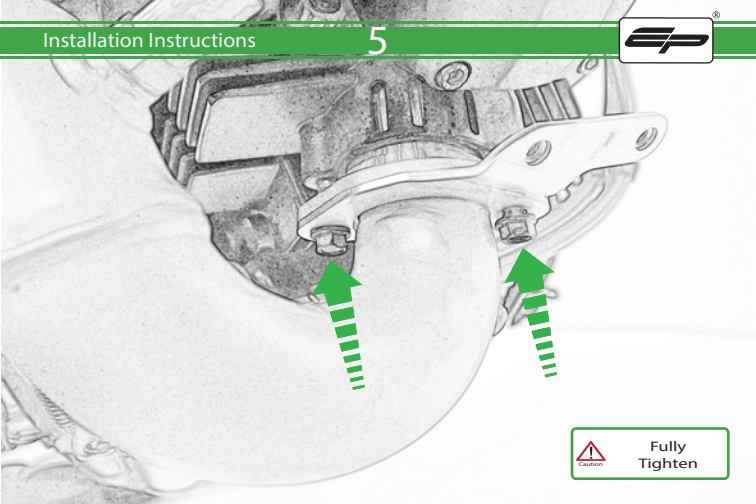

 **Fully Tighten**

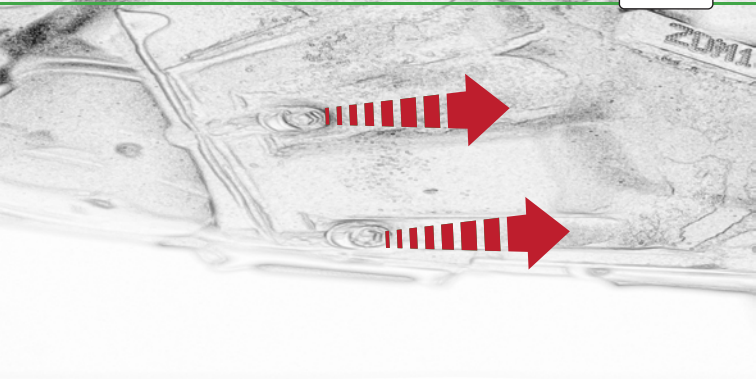

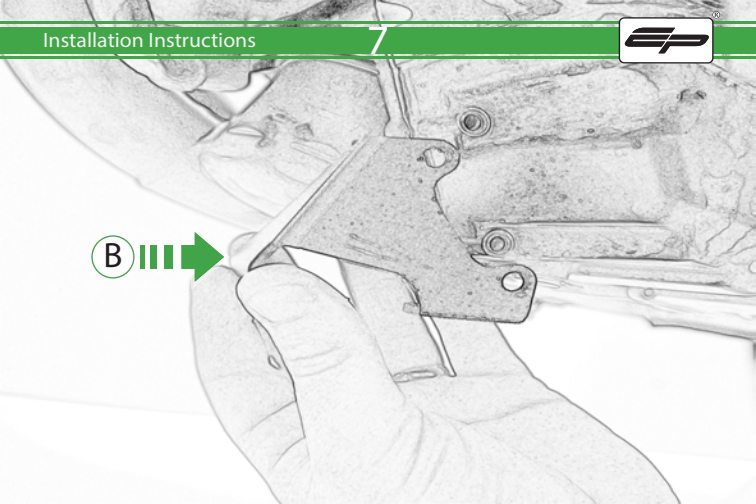

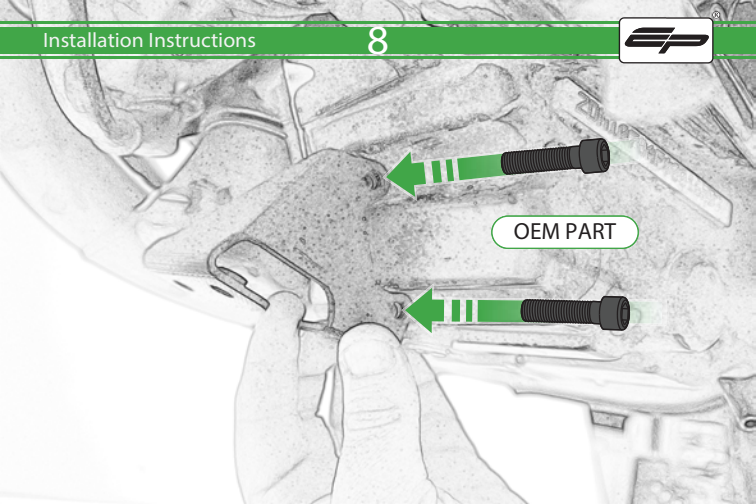

OEM PART

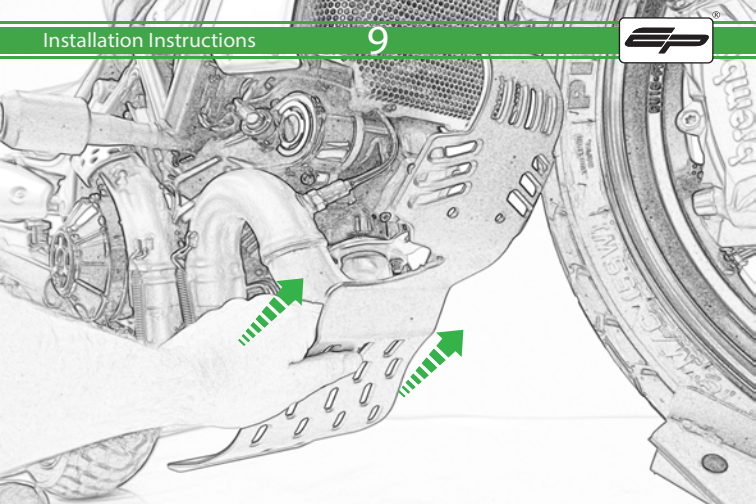

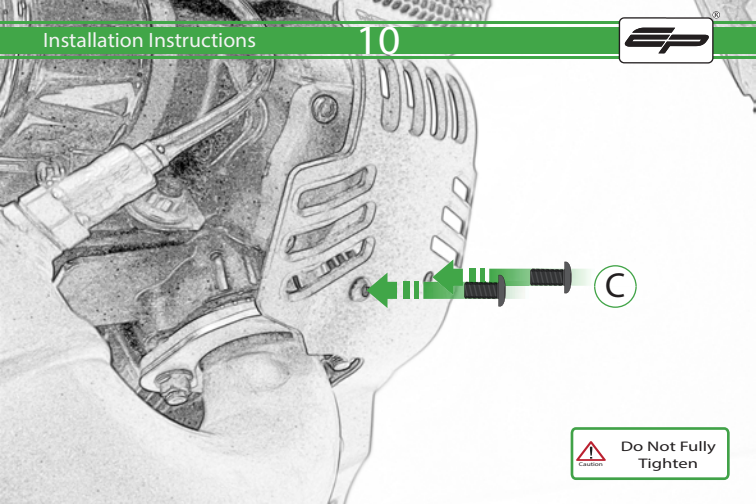

C

 Do Not Fully Tighten

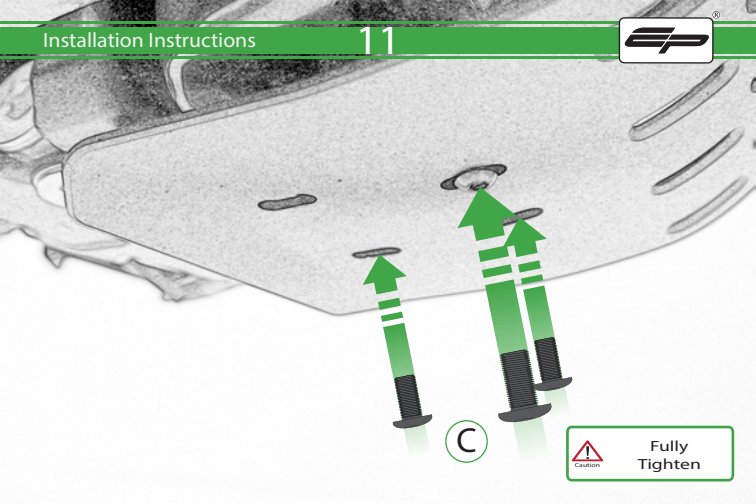

C

 Fully Tighten

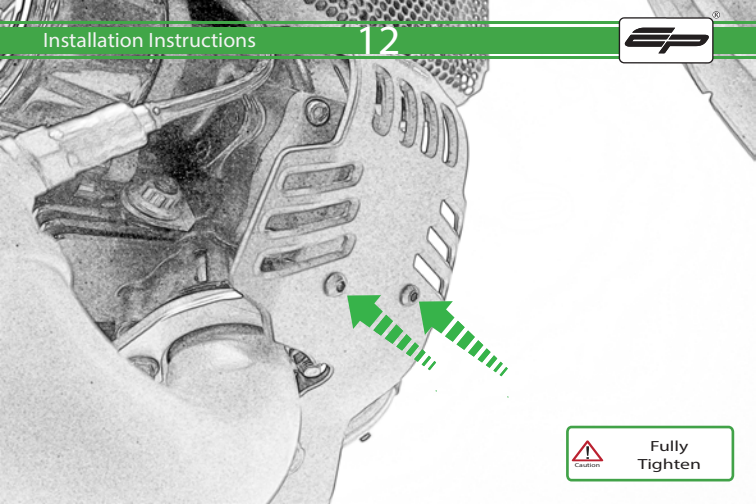

 **Fully Tighten**



 **ESSENTIAL CHECKS** 

It is recommended that periodic inspections are made to ensure that all bolts are tightened to the specified torque settings.

Should the bike be involved in an accident a thorough inspection should be made and any components that have taken an impact, no matter how small, be replaced



EVOTECH®
P E R F O R M A N C E

www.evotech-performance.com