



**EVOTECH**®  
P E R F O R M A N C E

[www.evotech-performance.com](http://www.evotech-performance.com)

Yamaha Tracer 9  
Garmin Sat Nav Mount



## Kit Contents PRN014566-015834

- |  |   |
|--|---|
| (A) 1 x Main Plate                       | (L) 2 x M4 x 5mm Black Button Head Bolts  |
| (B) 1 x Pivot Plate                      | (M) 4 x M4 x 10mm Black Button Head Bolts |
| (C) 1 x Sub Mounting Bracket             |   |
| (D) 2 x M5 x 8mm Black Button Head Bolts |   |
| (E) 2 x P-clips (No.1)                   |   |
| (F) 2 x P-clips (No.2)                   |   |
| (G) 2 x P-clips (No.3)                   | Sub Kit                                   |
| (H) 2 x P-clips (No.4)                   | (N) 1 x M5 x 12 Caphead                   |
| (I) 2 x Lobe Screw                       | (O) 1 x T-Clamp Bracket                   |
| (J) 2 x M5 Black Washer                  | (P) 3 x M5 x 20 Flange Bolt               |
| (K) 2 x Locking Washer                   |   |

P E R F O R M A N C E

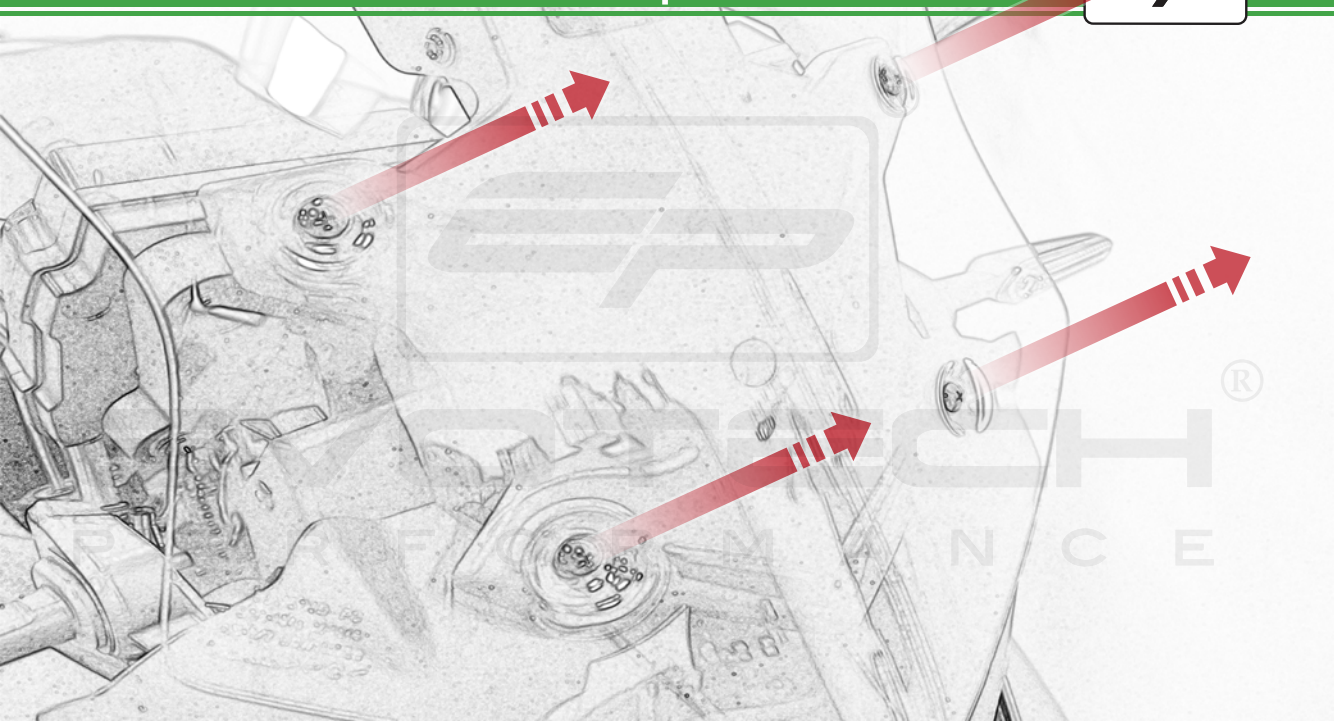

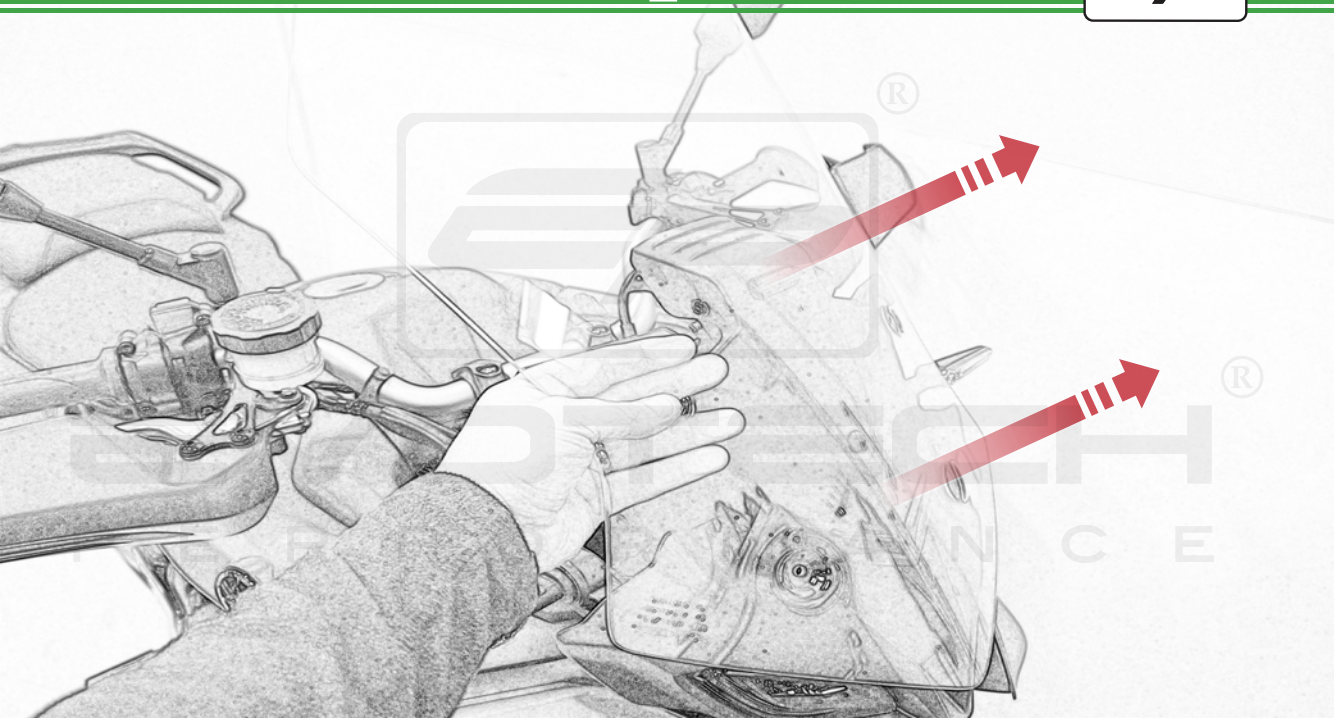

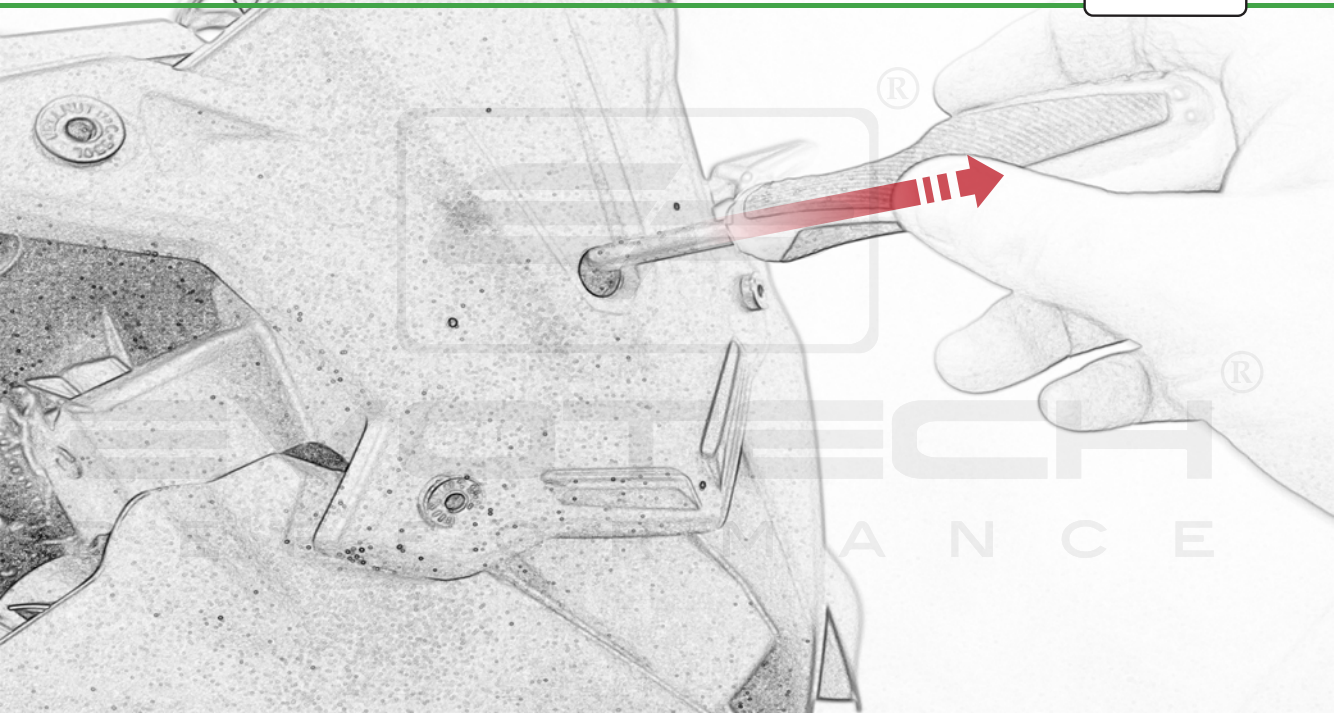

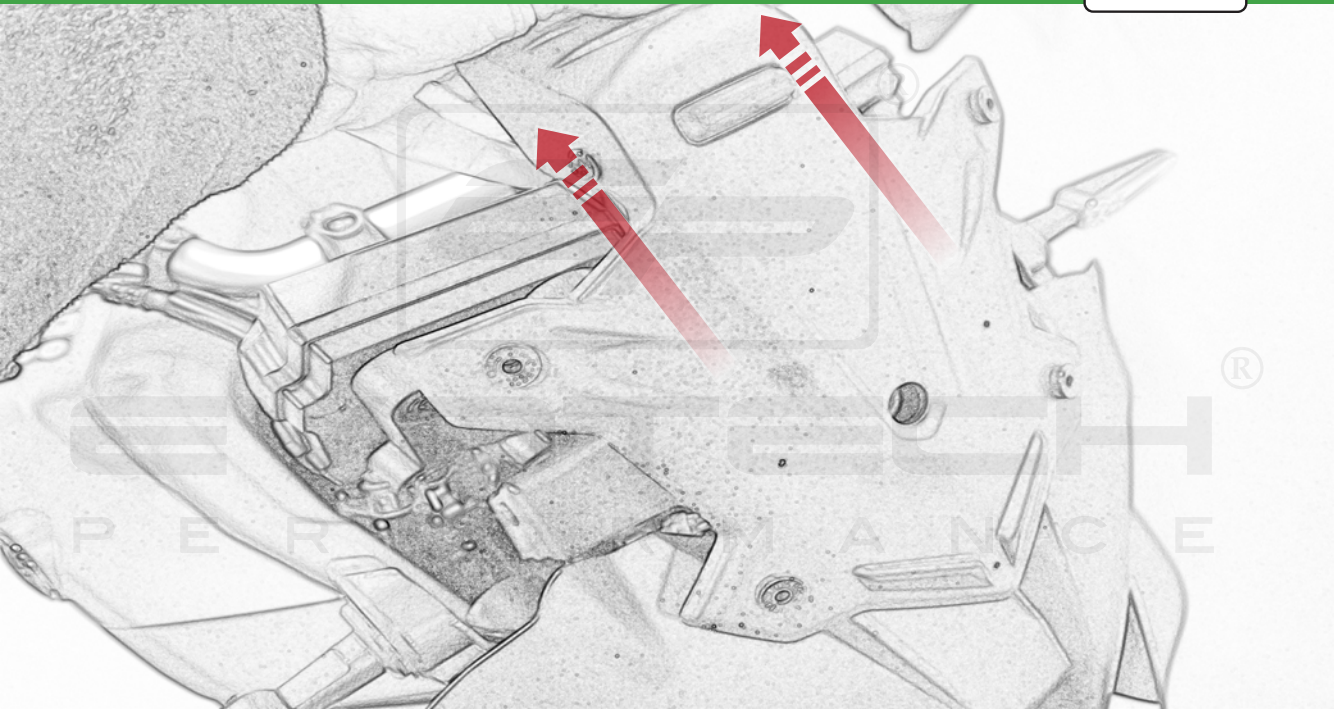

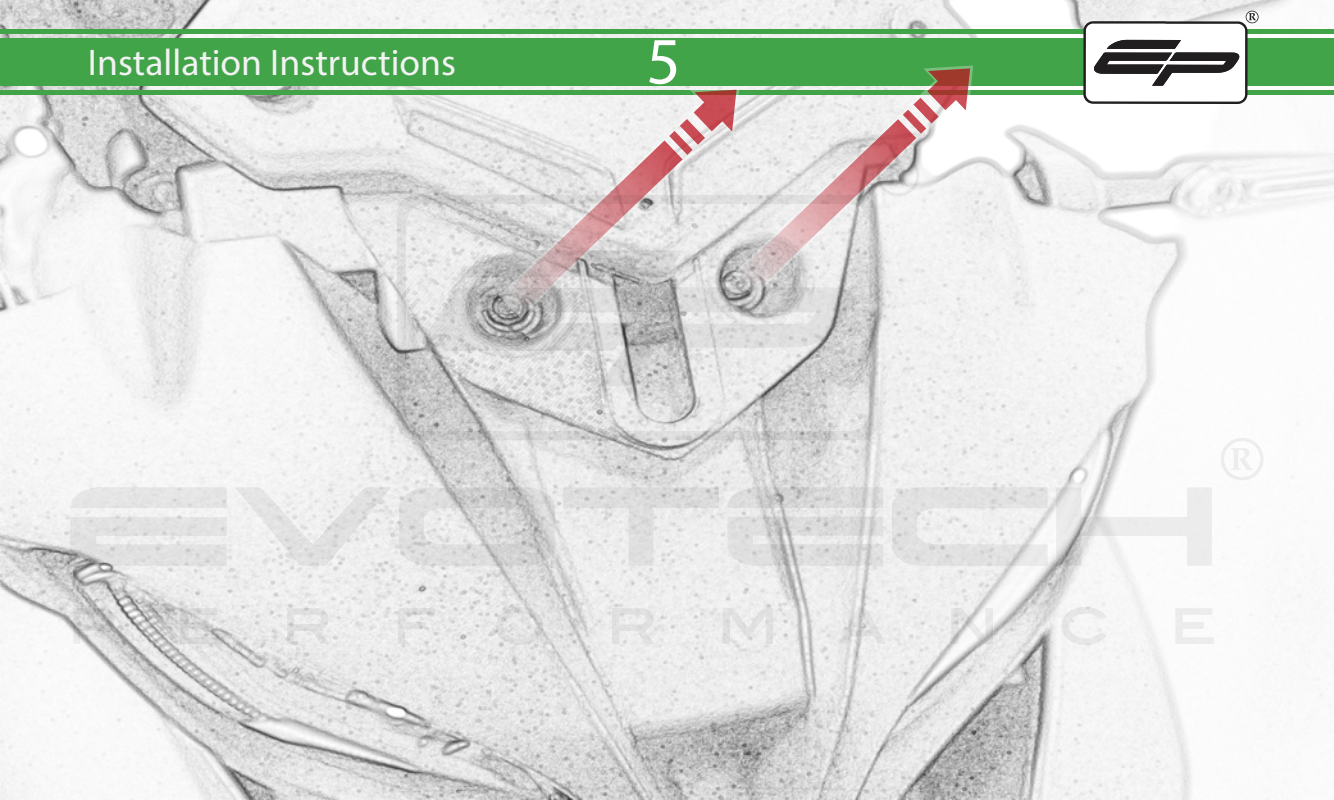

EVO TECH<sup>®</sup>  
PERFORMANCE

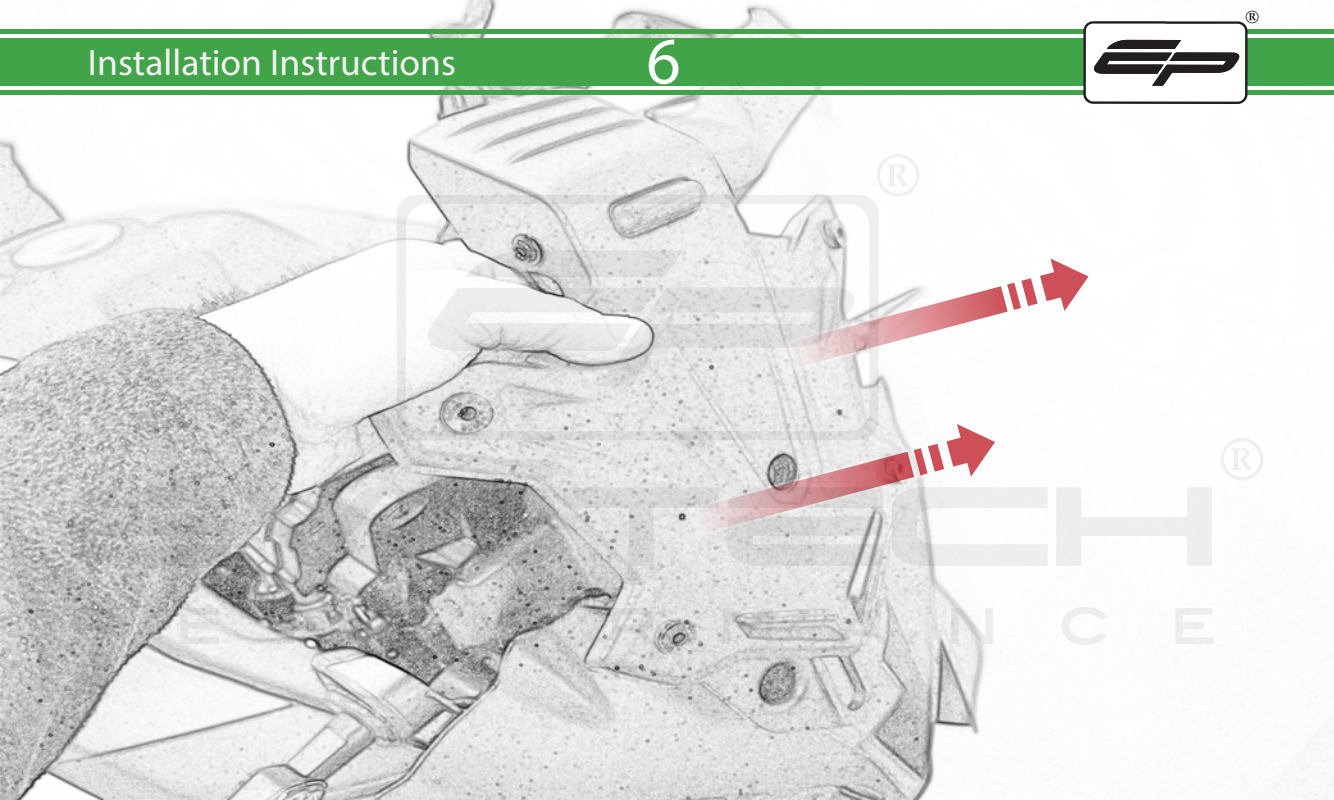



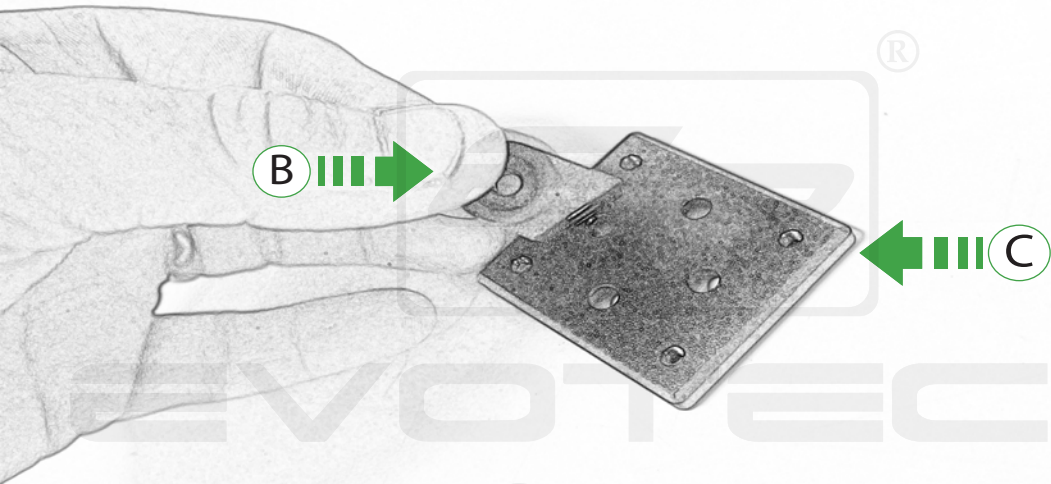

P E R F O R M A N C E

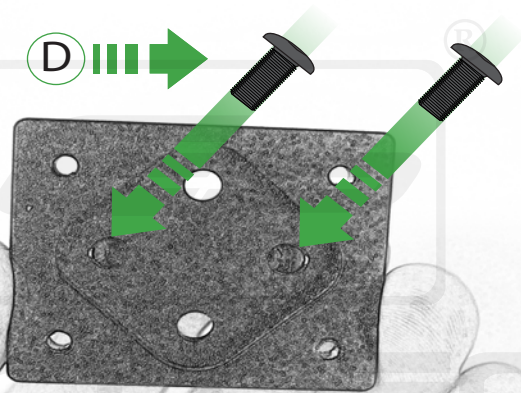

EVOLVOCH®  
P E R F O R M A N C E

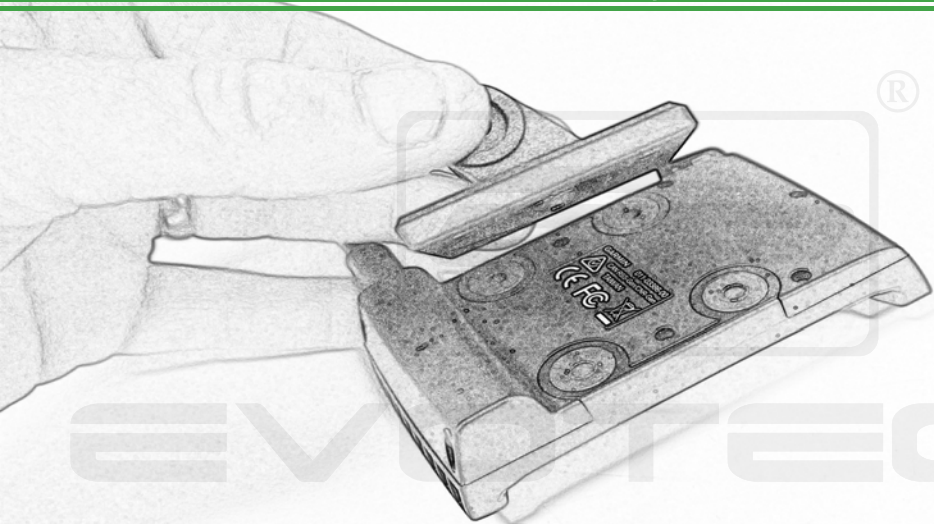

EVERTECH<sup>®</sup>  
P E R F O R M A N C E

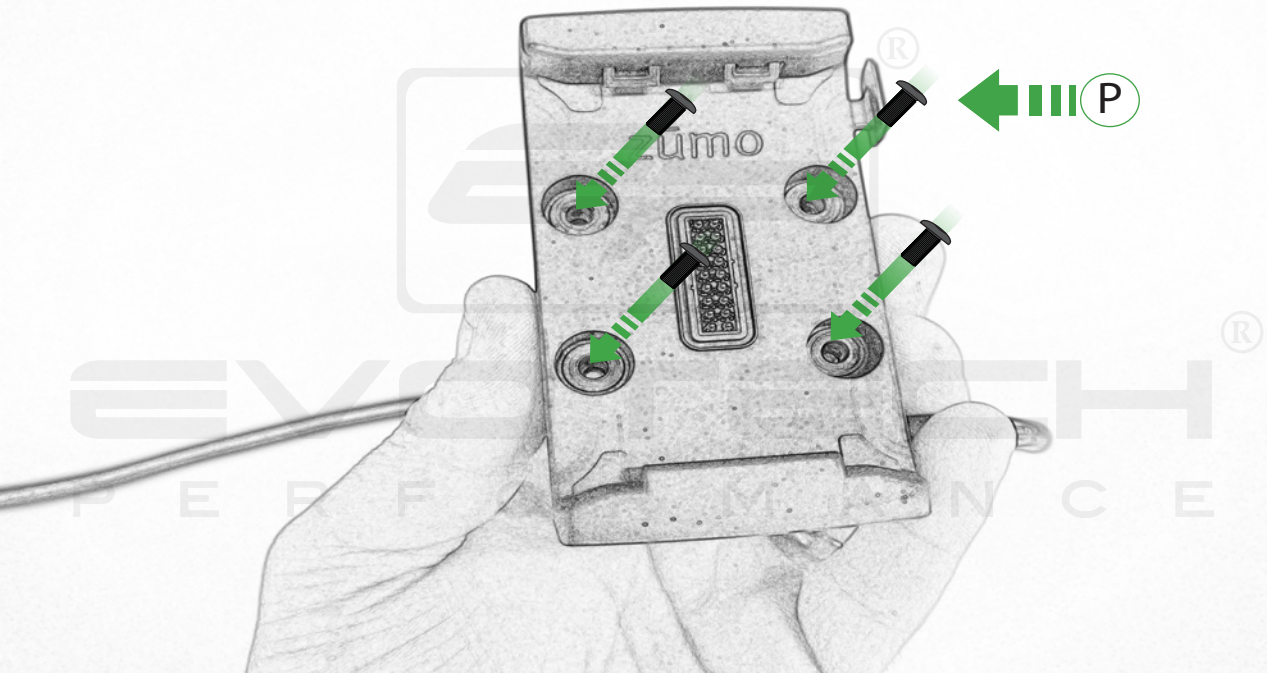



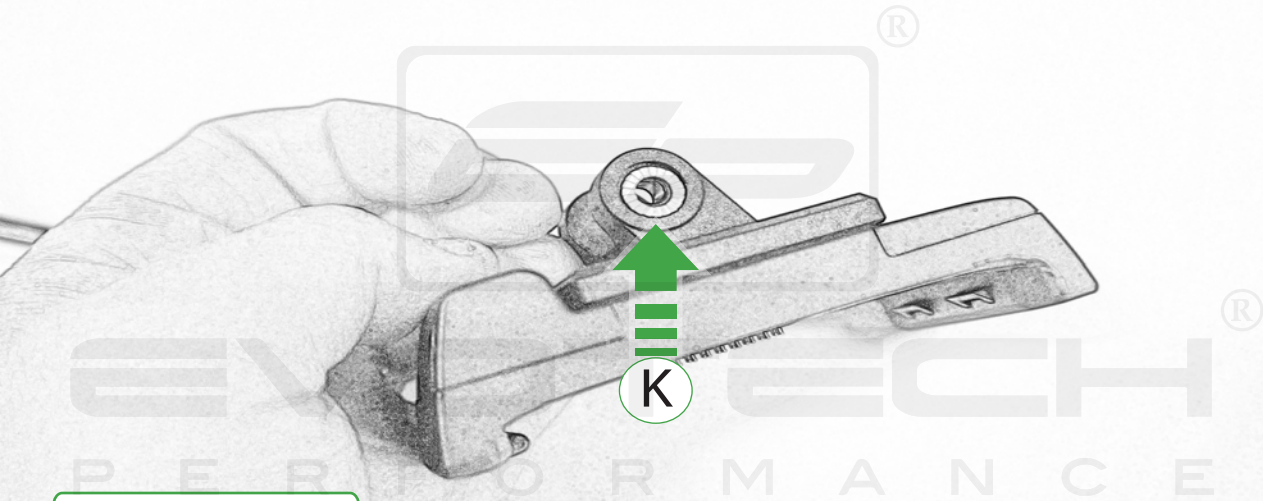

Repeat  
Both Sides

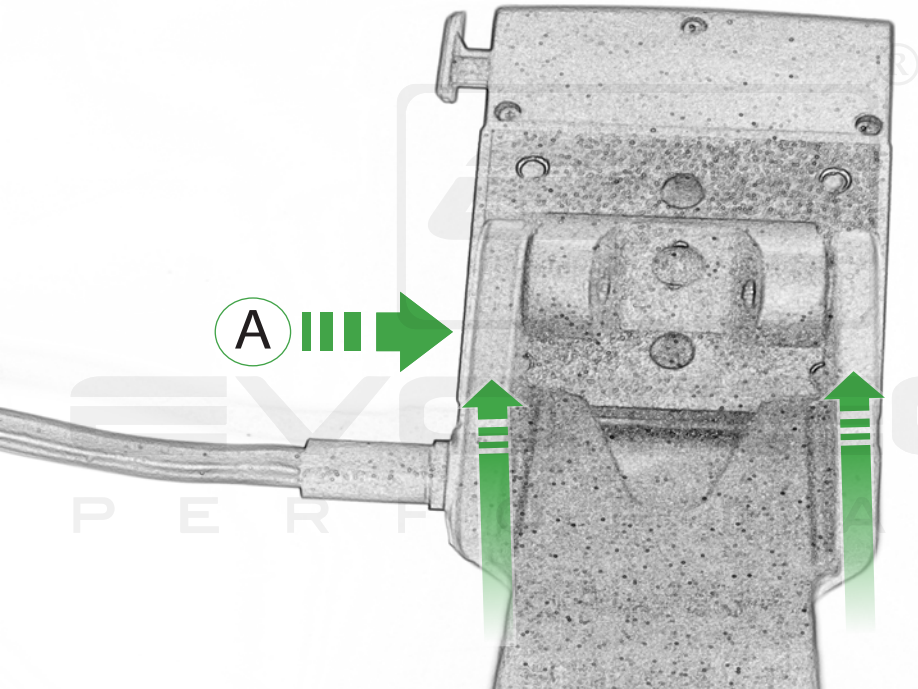

A



PERFORMANCE

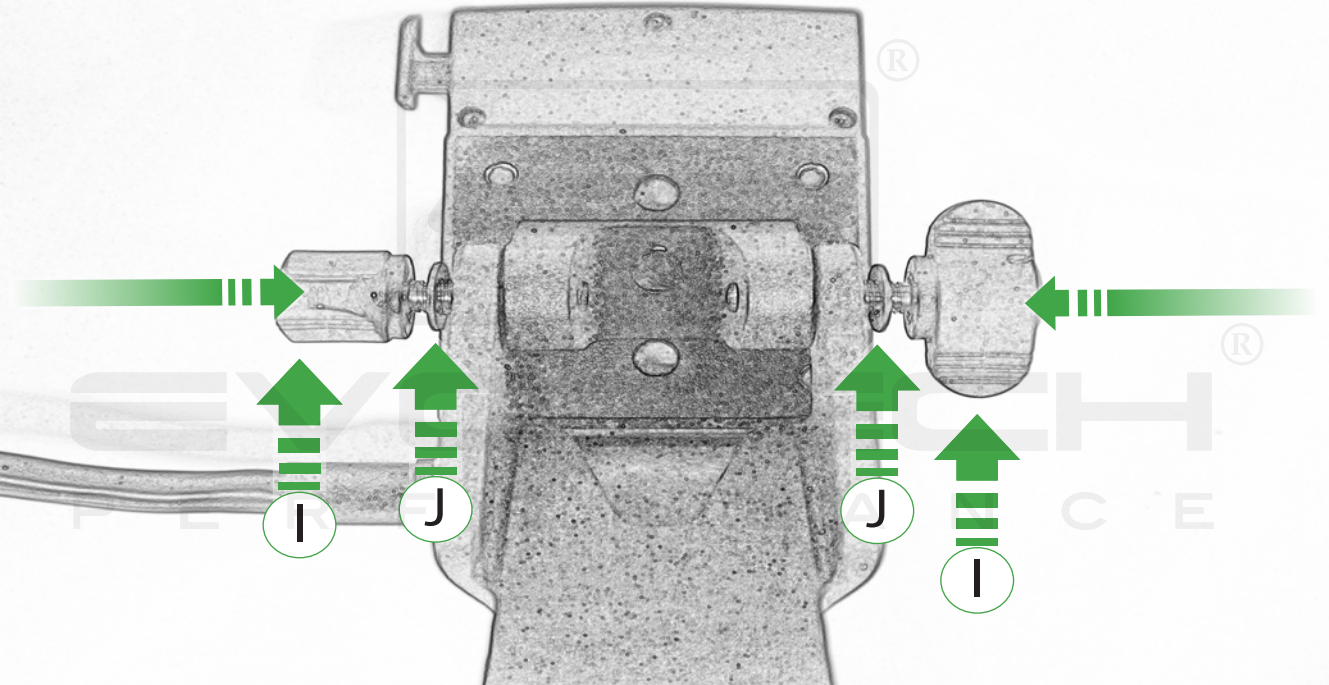



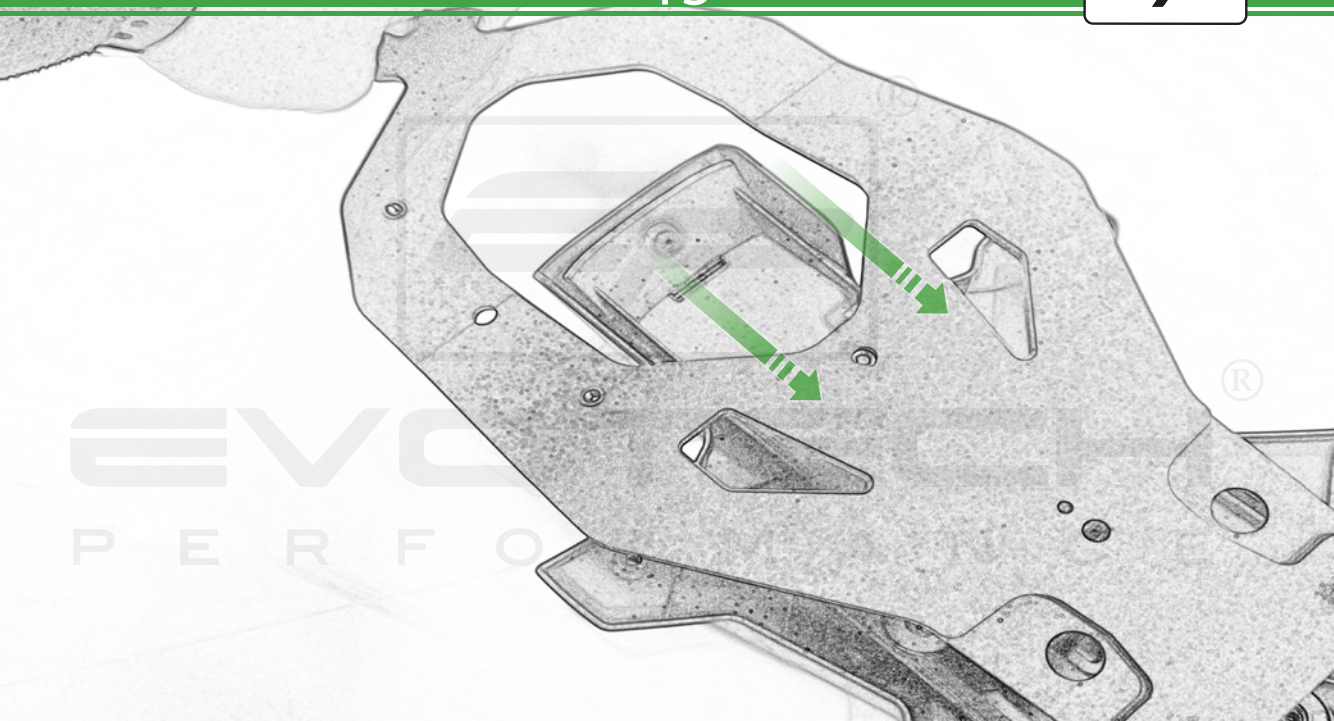

EVO  
PERFO



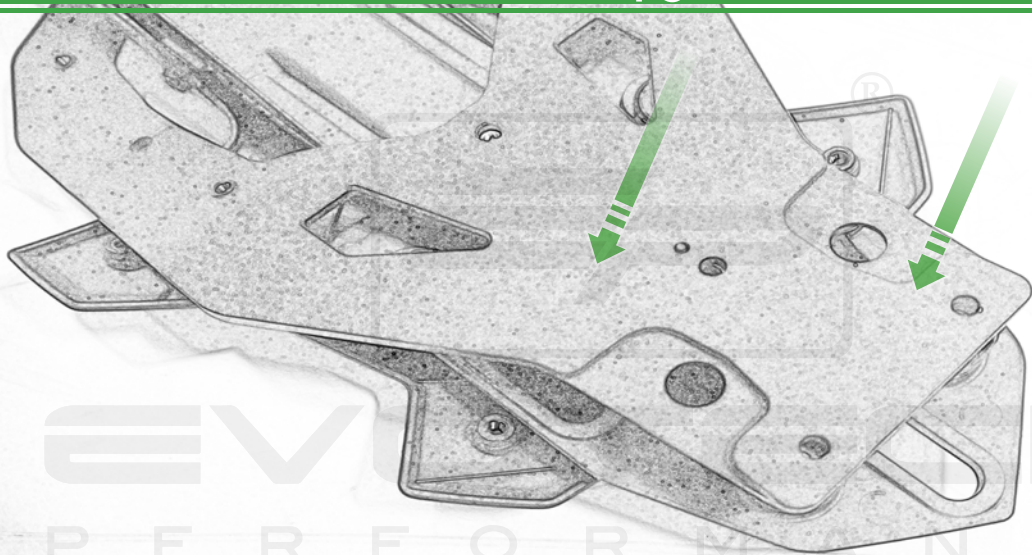

EP PERFORMANCE

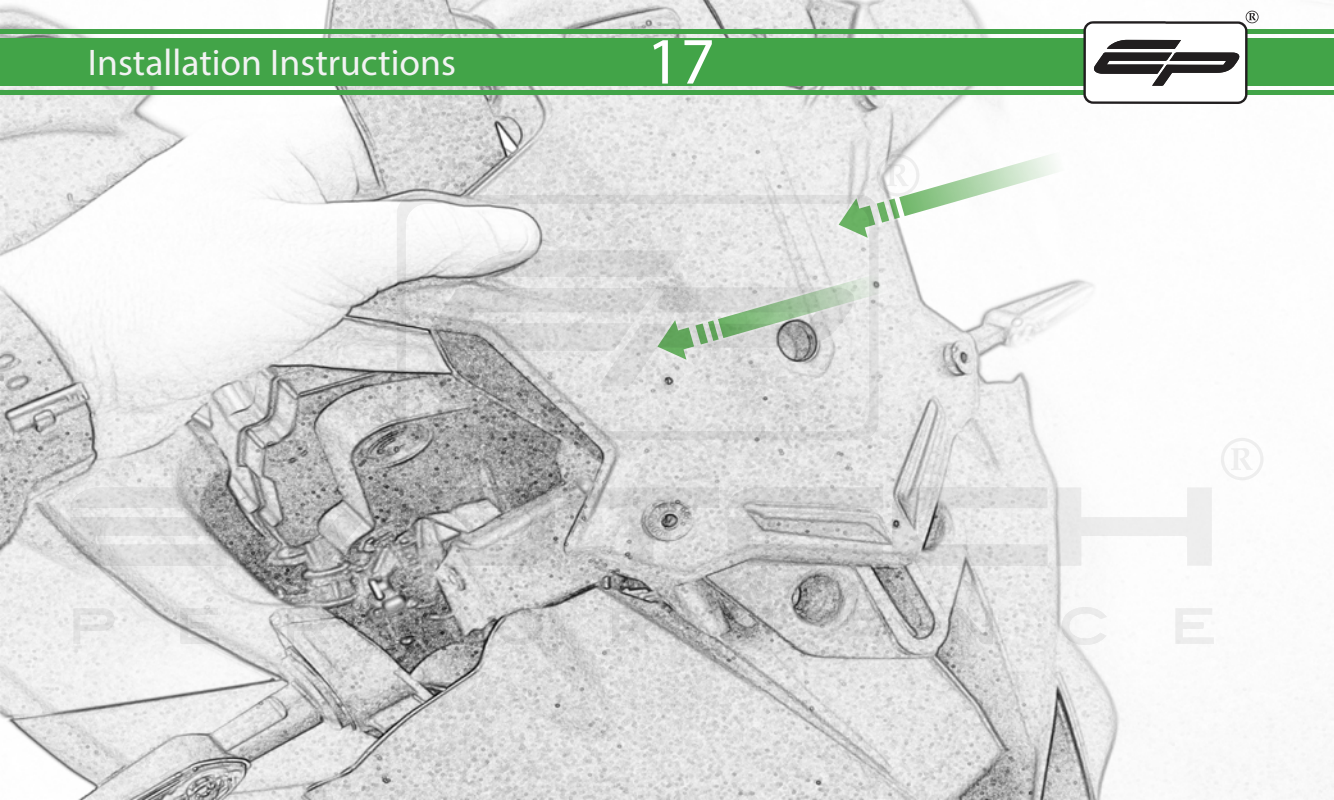

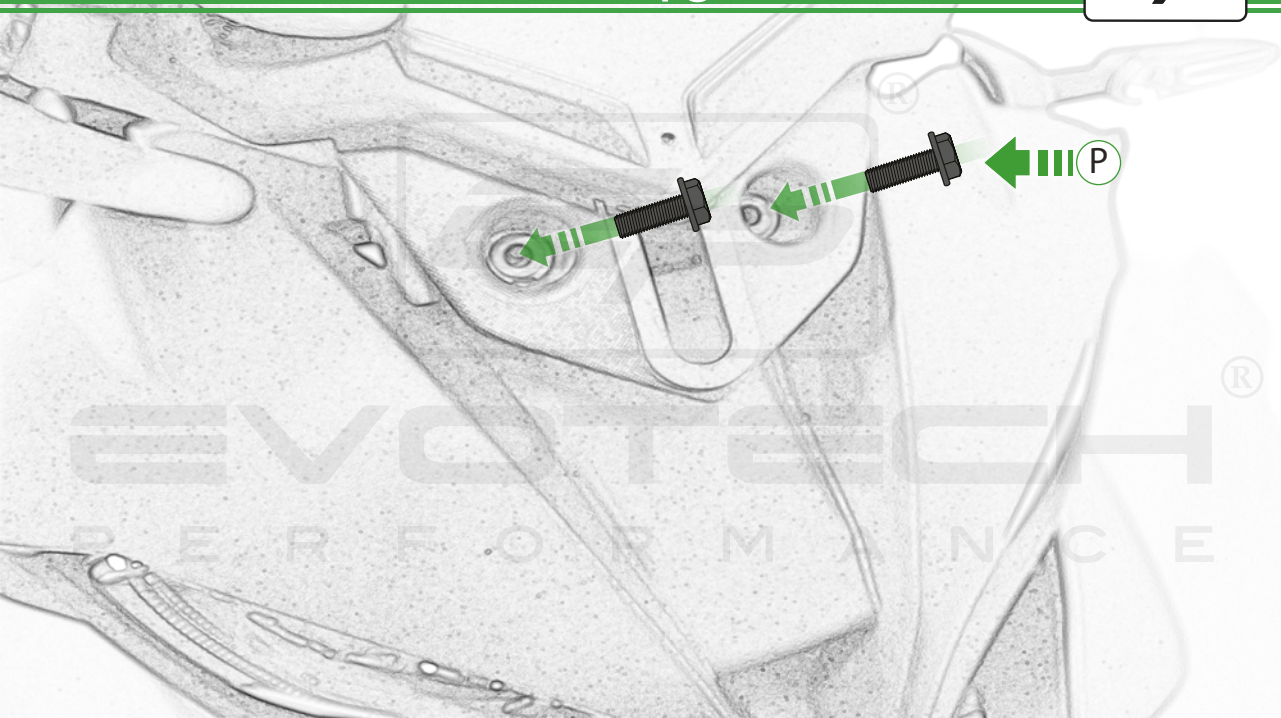

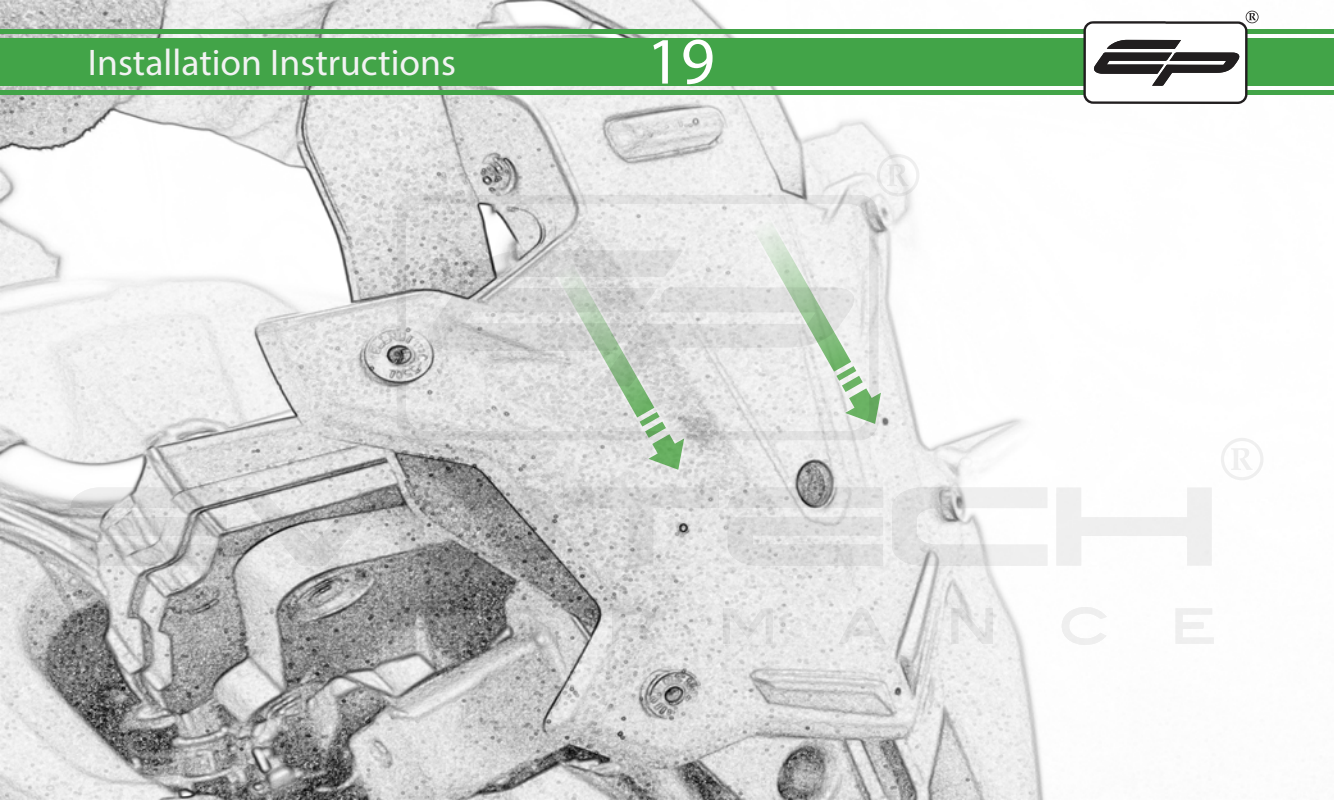

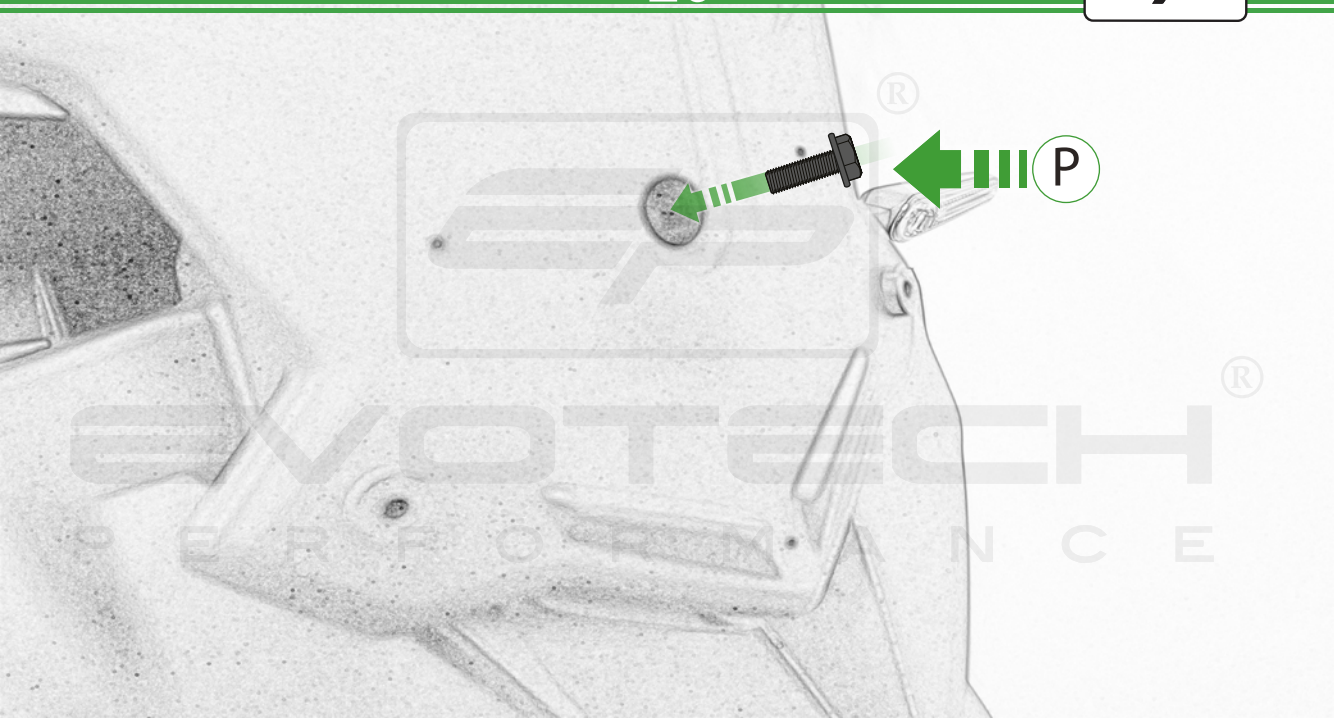

®

P

®

EVOTECH<sup>®</sup>  
PERFORMANCE

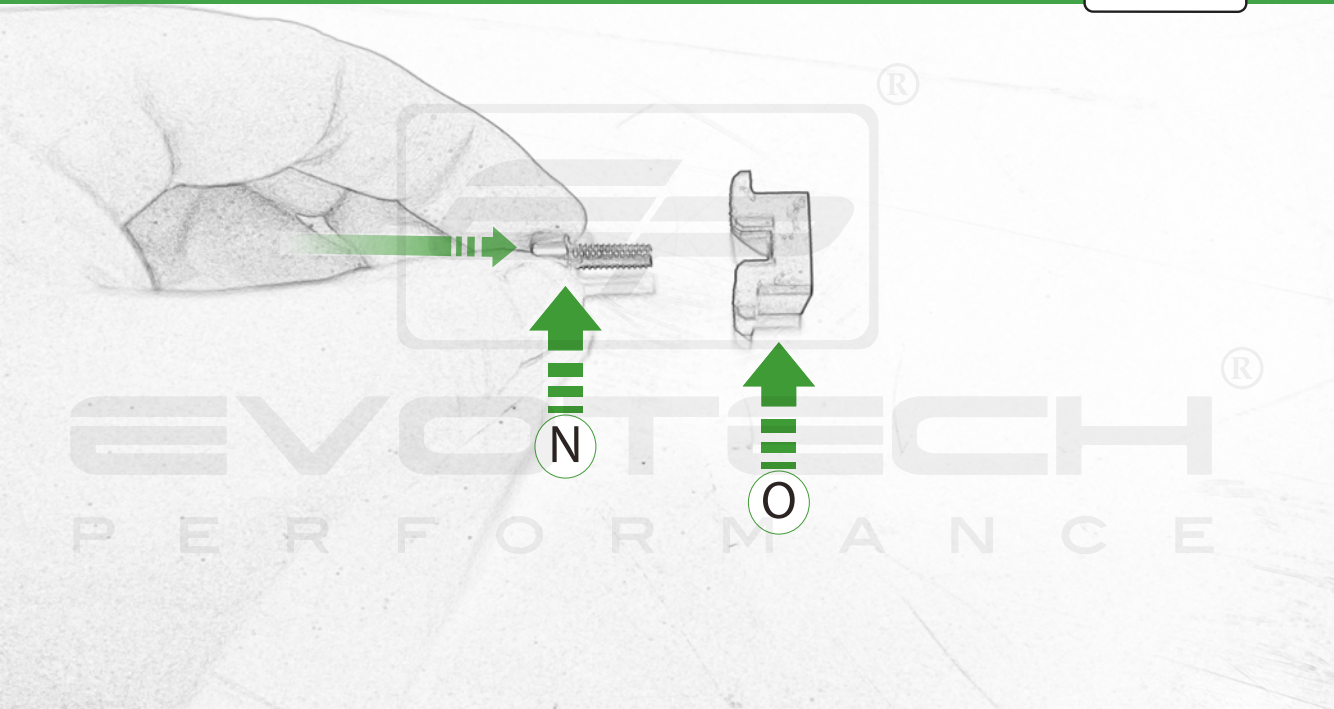

N

O

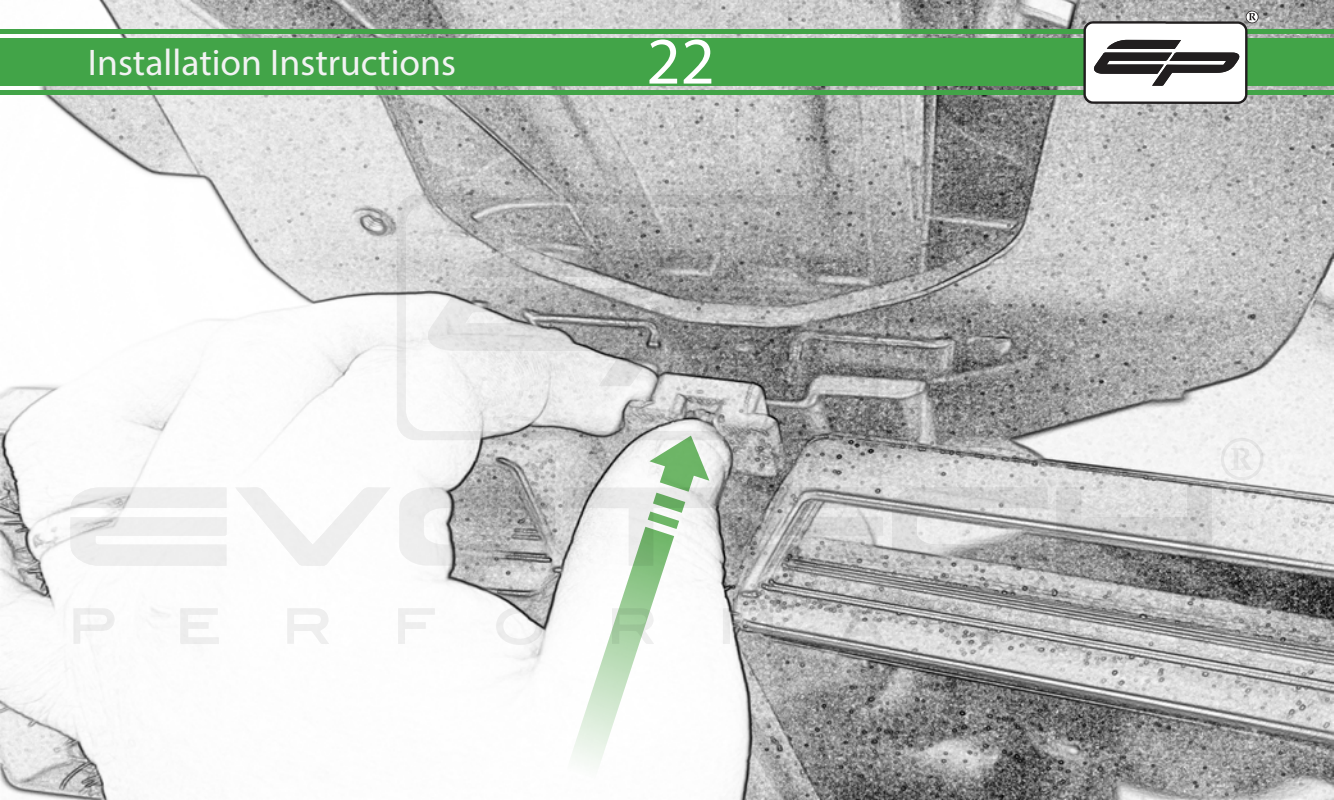



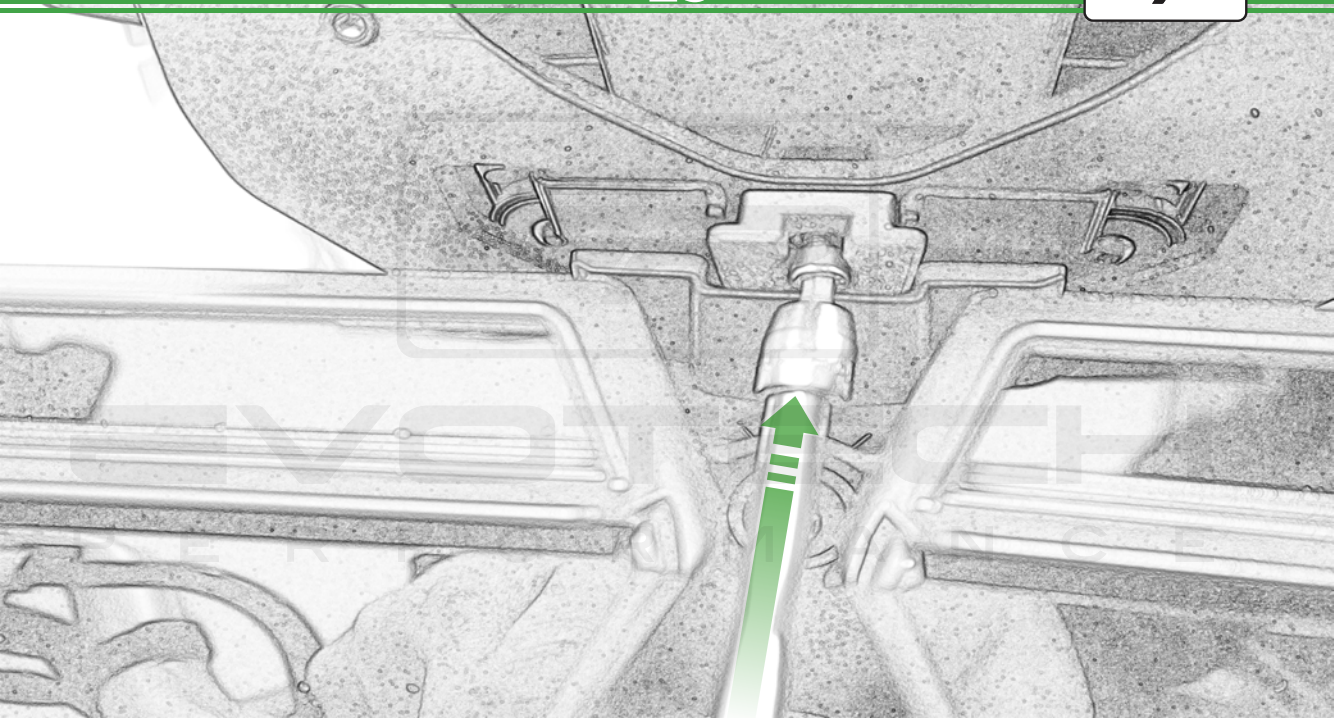

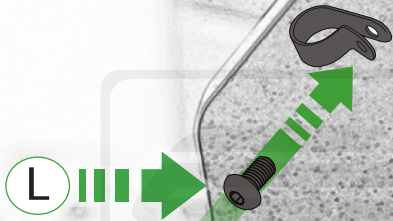



## **ESSENTIAL CHECKS**

It is recommended that periodic inspections are made to ensure that all bolts are tightened to the specified torque settings.

Should the bike be involved in an accident a thorough inspection should be made and any components that have taken an impact, no matter how small, be replaced

**EVOTECH** <sup>®</sup>  
P E R F O R M A N C E



**EVOTECH**®  
P E R F O R M A N C E

[www.evotech-performance.com](http://www.evotech-performance.com)