



EVOTECH®
P E R F O R M A N C E

Installation Instructions



DUCATI DIAVEL 2016 RADIATOR GUARD

Product Reference - 13089

Kit Contents

- Ⓐ 1 x Radiator Guard
- Ⓑ 1 x Neoprene Foam

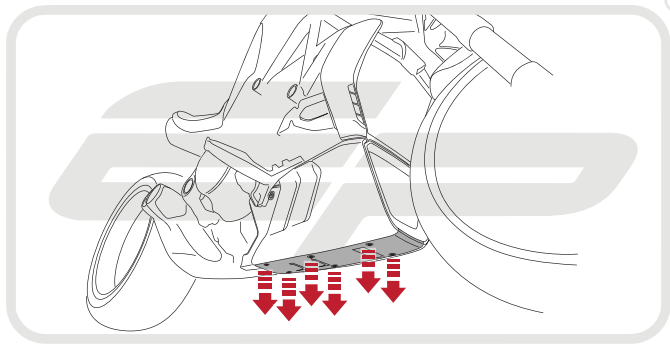

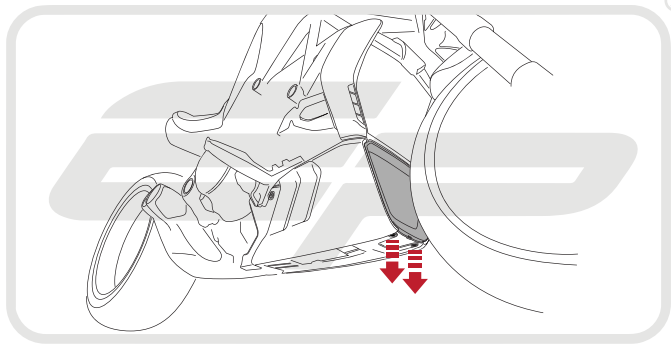

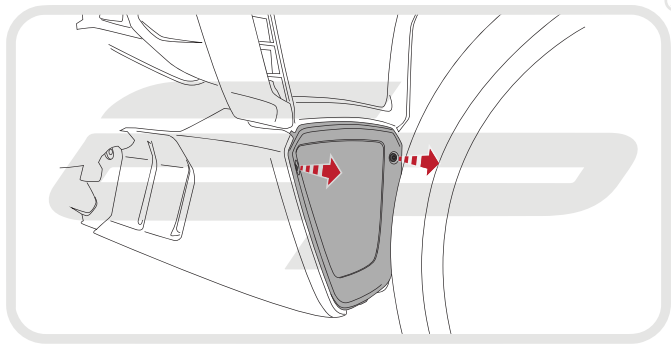

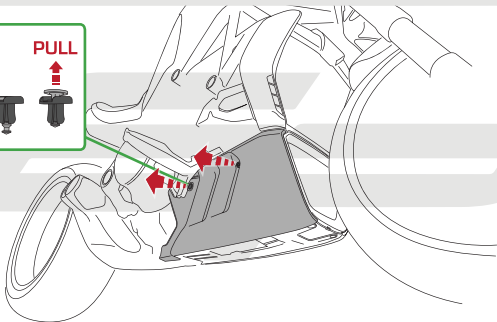
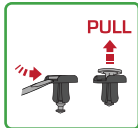

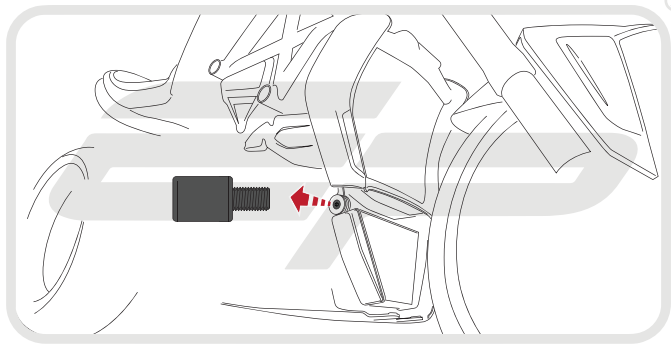

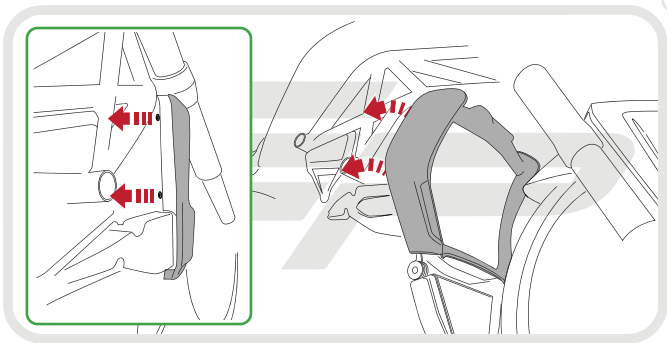

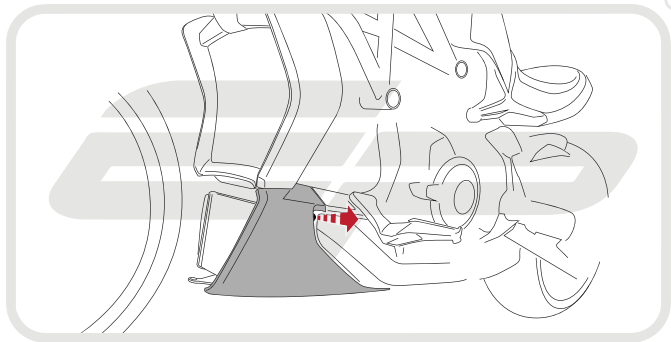

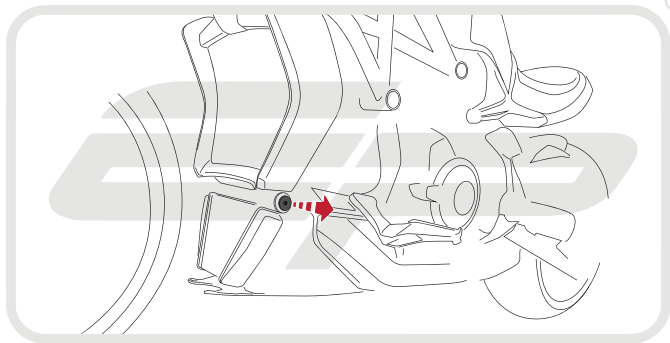



®

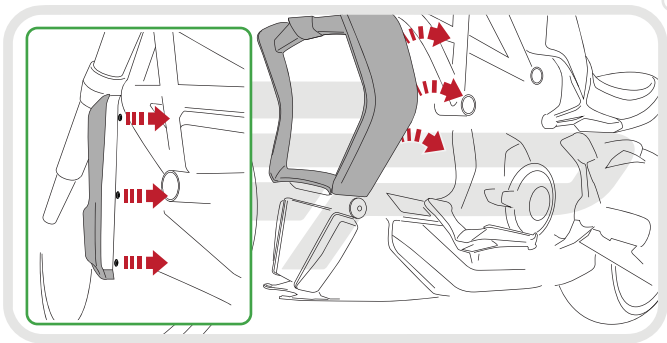

EVOTECH[®]
P E R F O R M A N C E

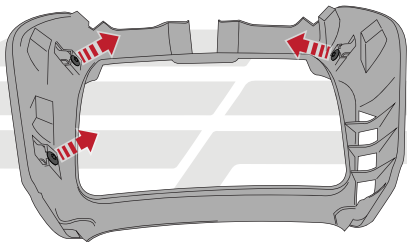

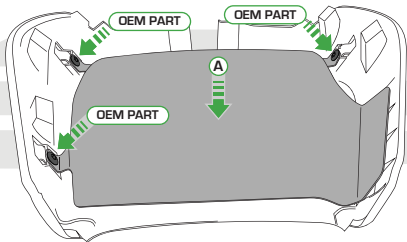

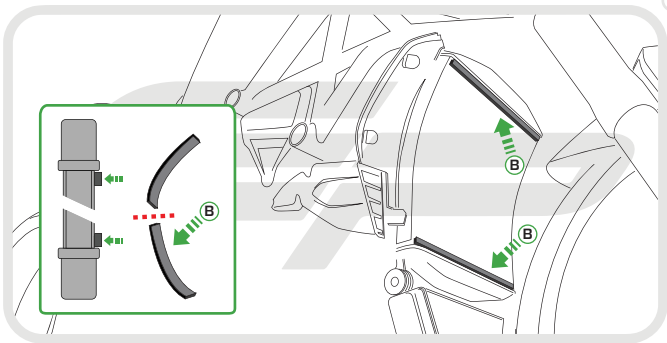



Reverse Stages

9 - 1



ESSENTIAL CHECKS

It is recommended that periodic inspections are made to ensure that dirt and debris have not become trapped between the guard and the radiator/oil cooler. Such dirt and debris would reduce the cooling efficiency of the radiator/oil cooler.

It is recommended that periodic inspections are made to ensure that all fixings are fully tightened.



EVOTECH®
P E R F O R M A N C E

www.evotech-performance.com