



BMW R nineT
Exhaust Hanger

Installation Instructions



Kit Contents PRN014254 / PRN014205

- Ⓐ 3 x M8 x 20 Black/Silver Button Head Bolts

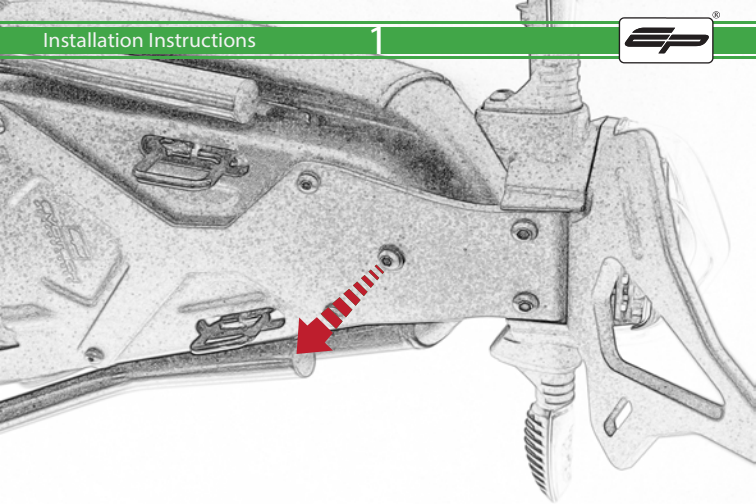

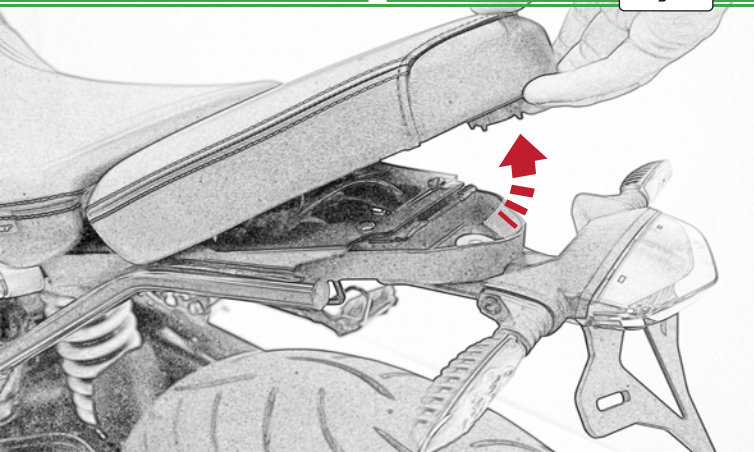

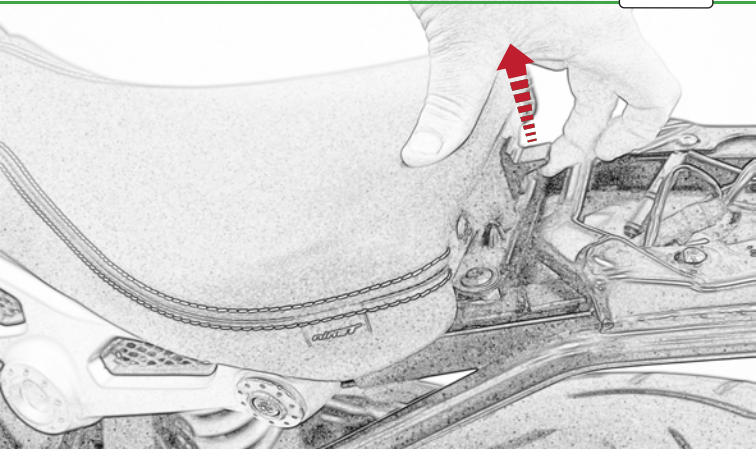



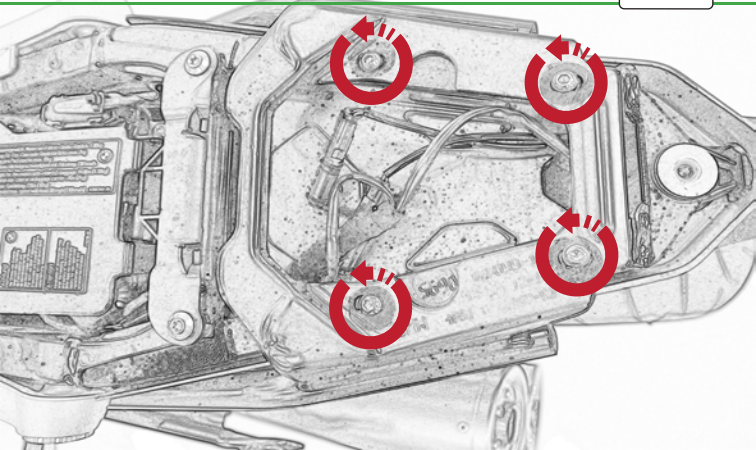

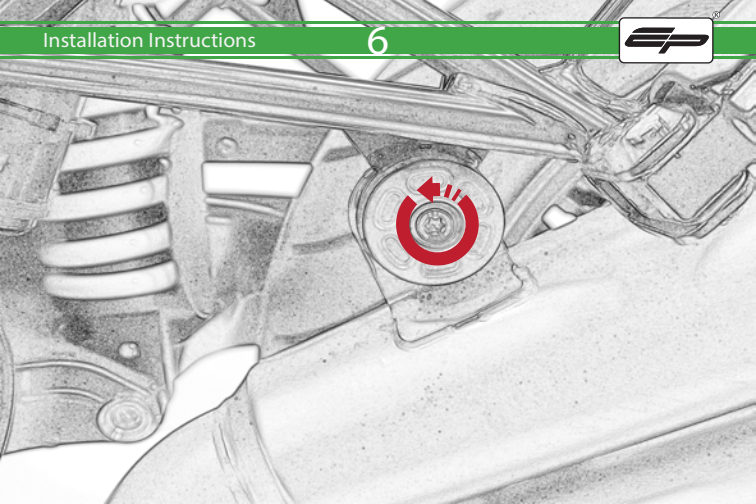

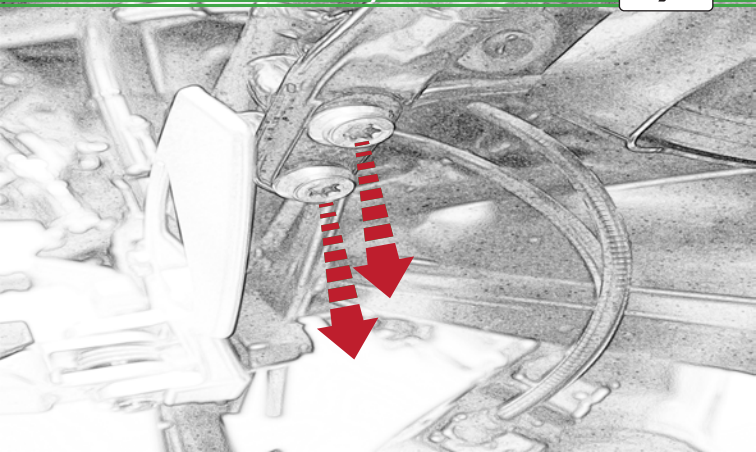

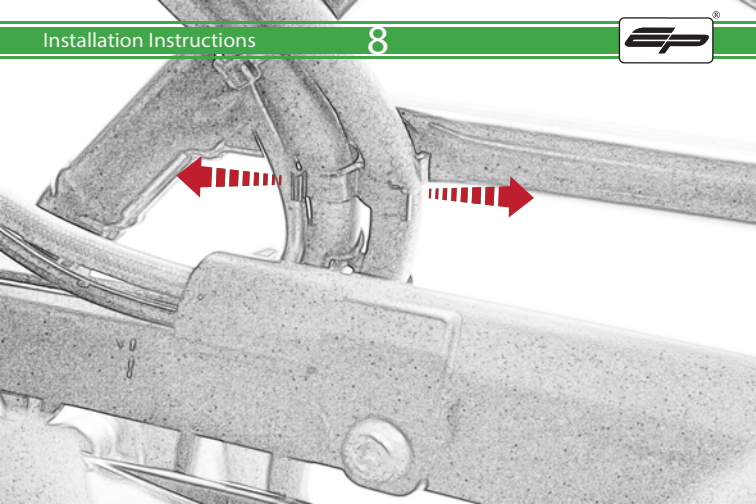

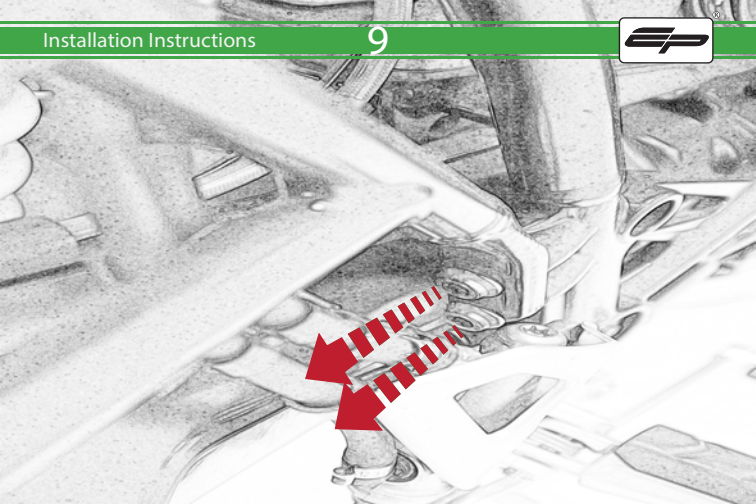

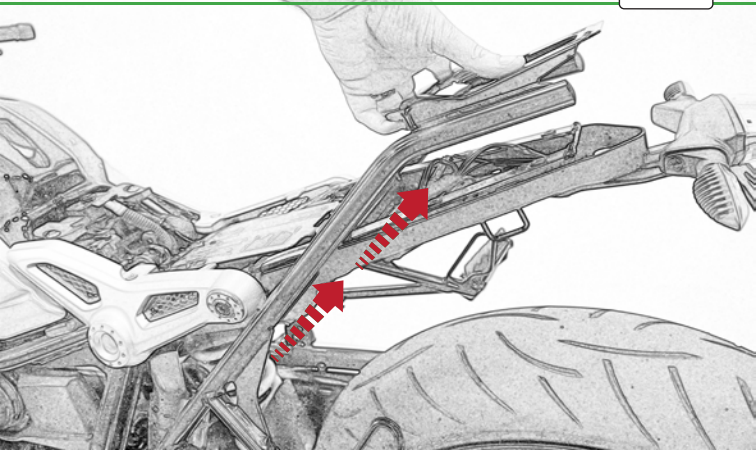

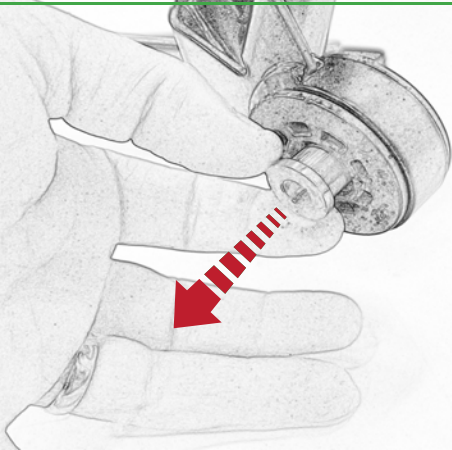

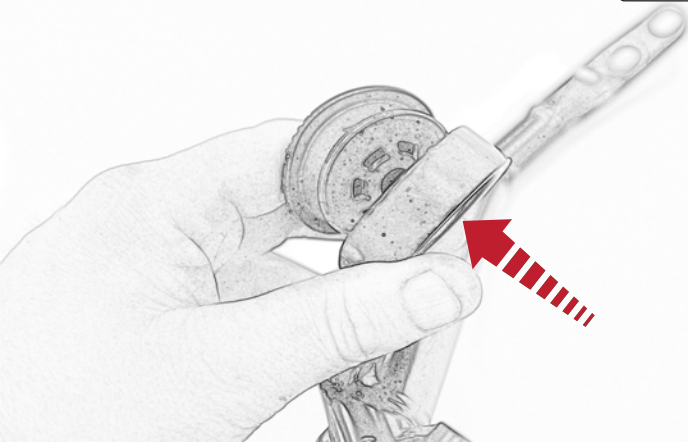

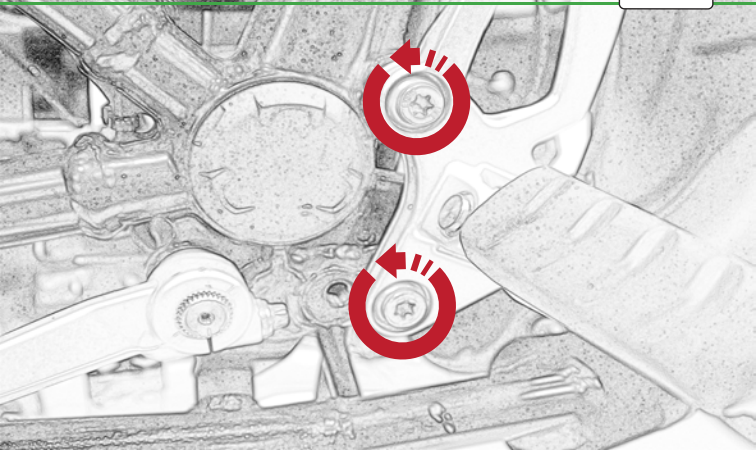

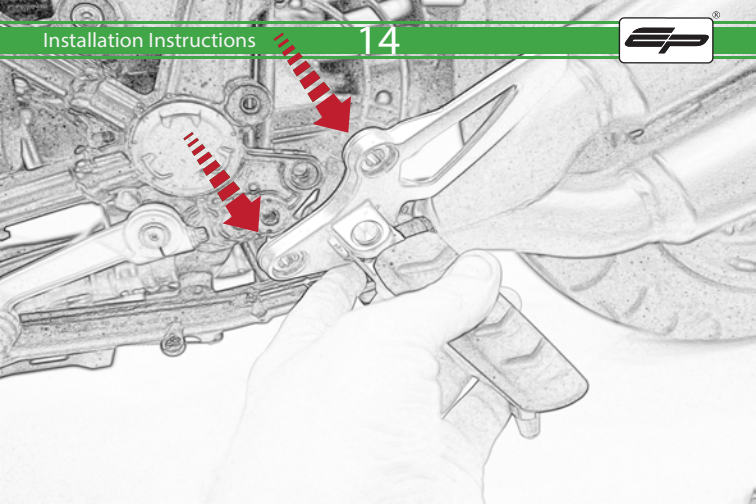

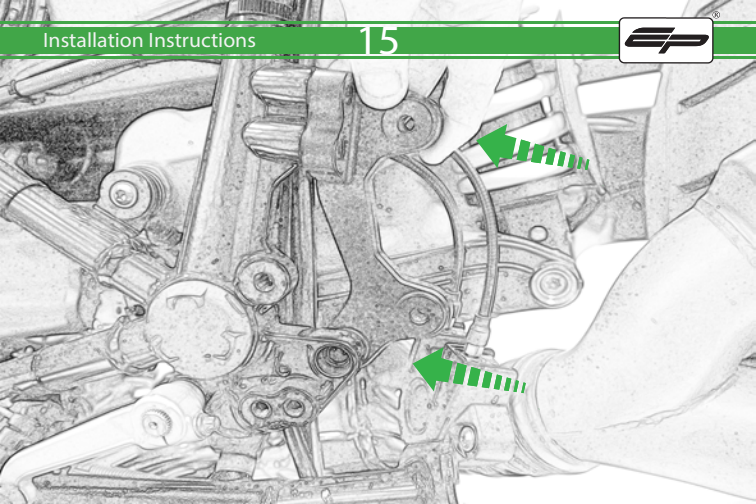

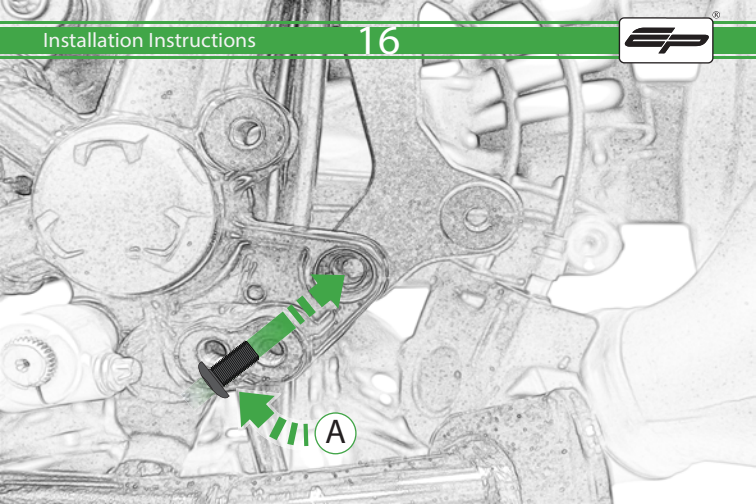



OEM PART



OEM PART

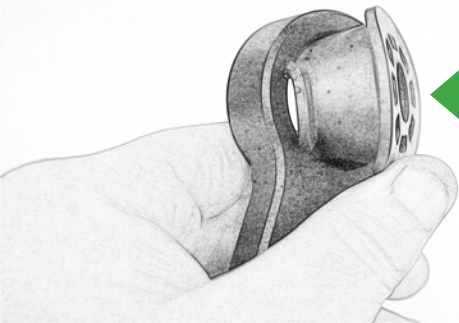

OEM PART



OEM PART

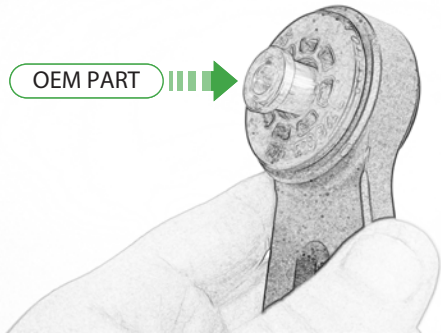

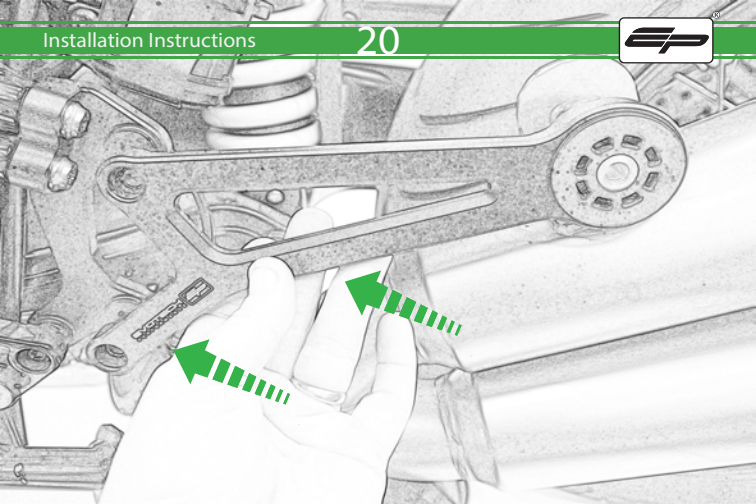

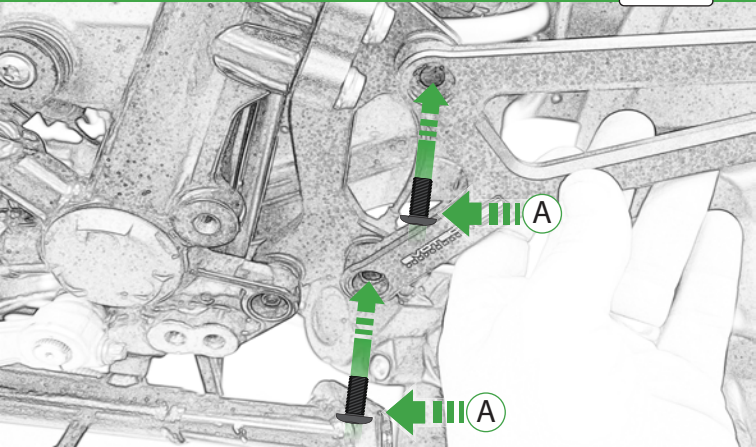

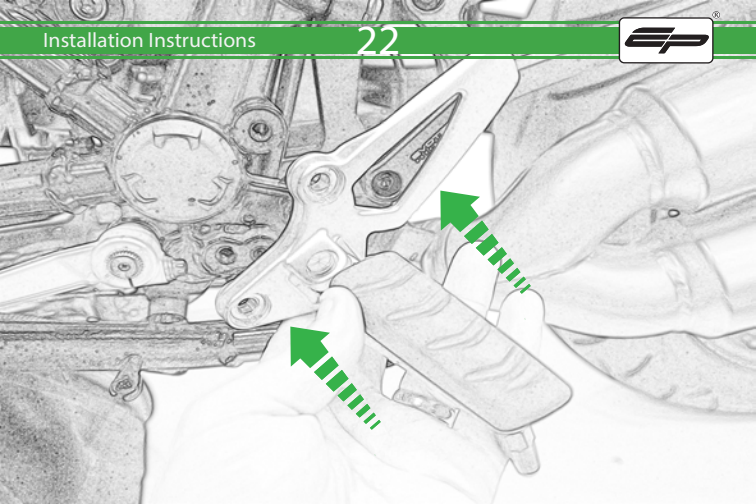

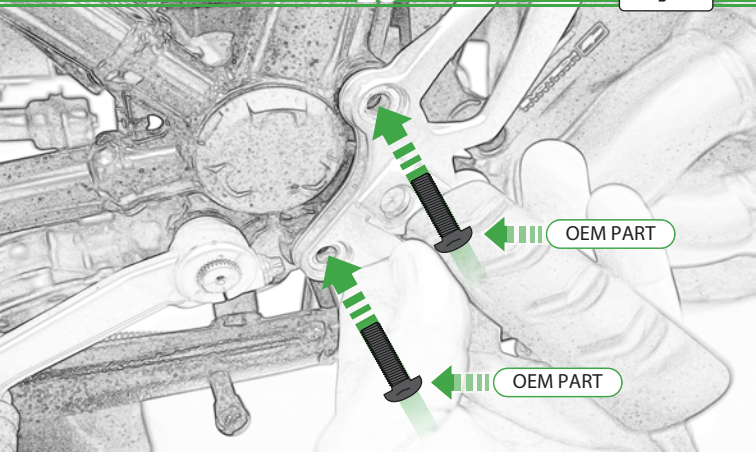

OEM PART

OEM PART



OEM PART

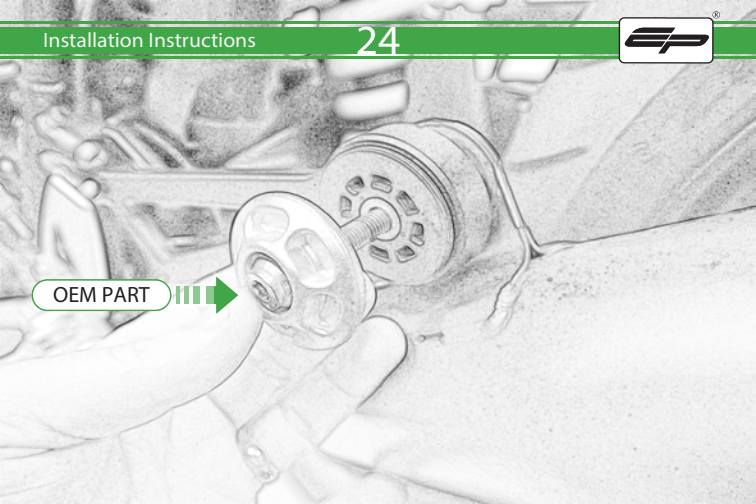

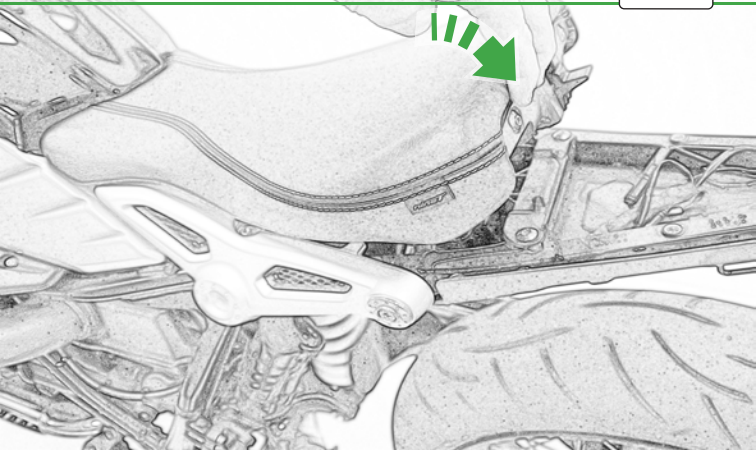



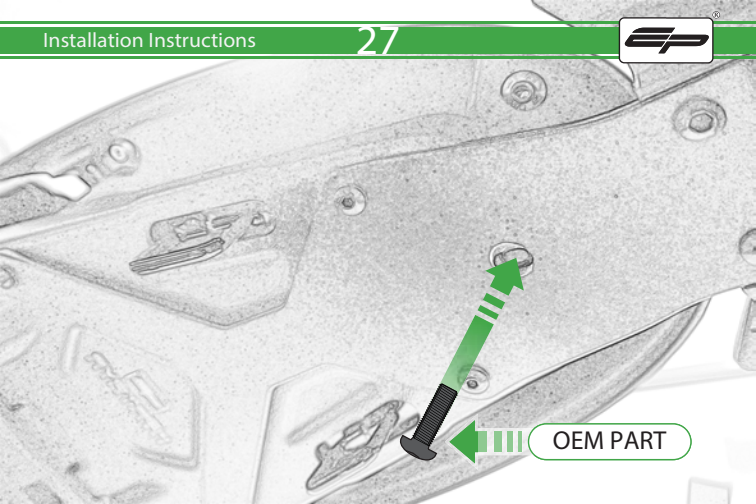

OEM PART



 **ESSENTIAL CHECKS** 

It is recommended that periodic inspections are made to ensure that all bolts are tightened to the specified torque settings.

Should the bike be involved in an accident a thorough inspection should be made and any components that have taken an impact, no matter how small, be replaced



EVOTECH®
P E R F O R M A N C E

www.evotech-performance.com