

EVOTECH®
P E R F O R M A N C E

www.evotech-performance.com

Yamaha XSR900

Tail Tidy



- Ⓐ 1 x Lock Cover
- Ⓑ 1 x Retro Light
- Ⓒ 1 x Connector (No.28)
- Ⓓ 2 x P-Clip (No.3)
- Ⓔ 2 x M4 Flange Nut
- Ⓕ 2 x M4 x 10mm Black Button Head Bolts
- Ⓖ 4 x M6 x 20mm Black Button Head Bolts
- Ⓗ 4 x M6 Flange Nut
- Ⓘ 5 x M4 x 6mm Black Button Head Bolts

P E R F O R M A N C E

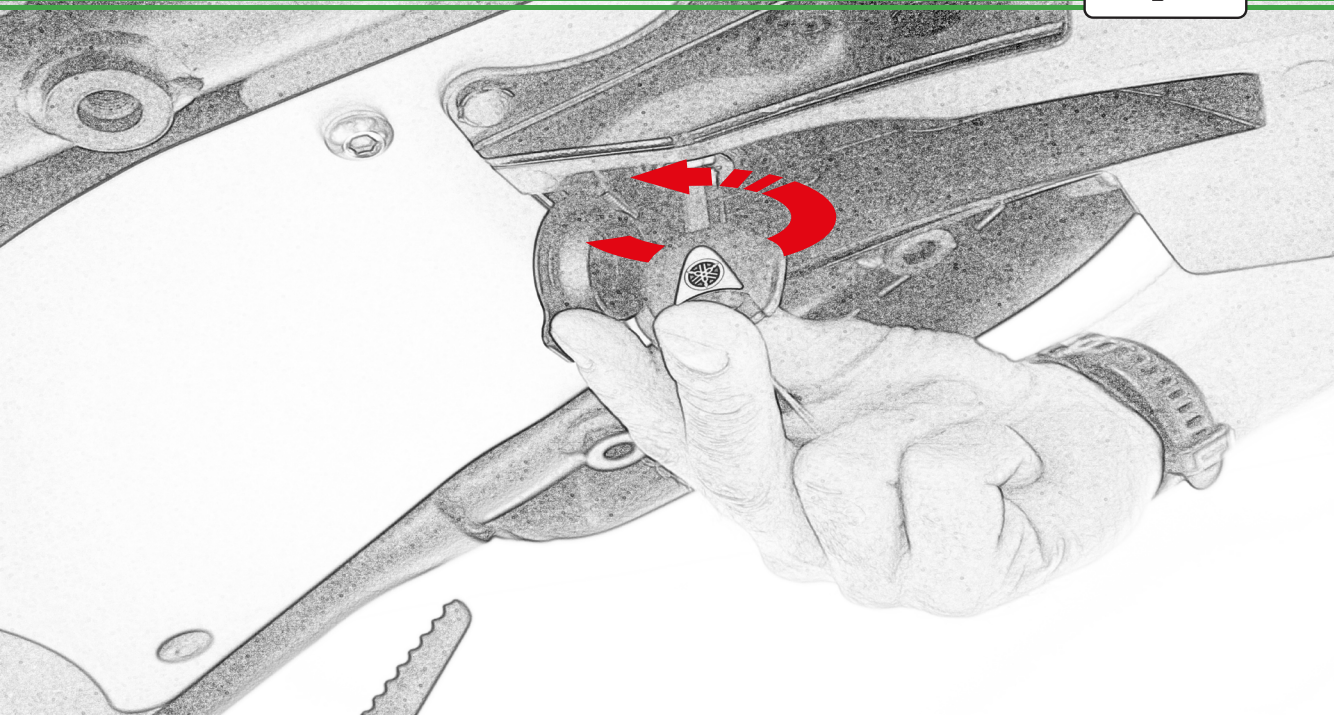

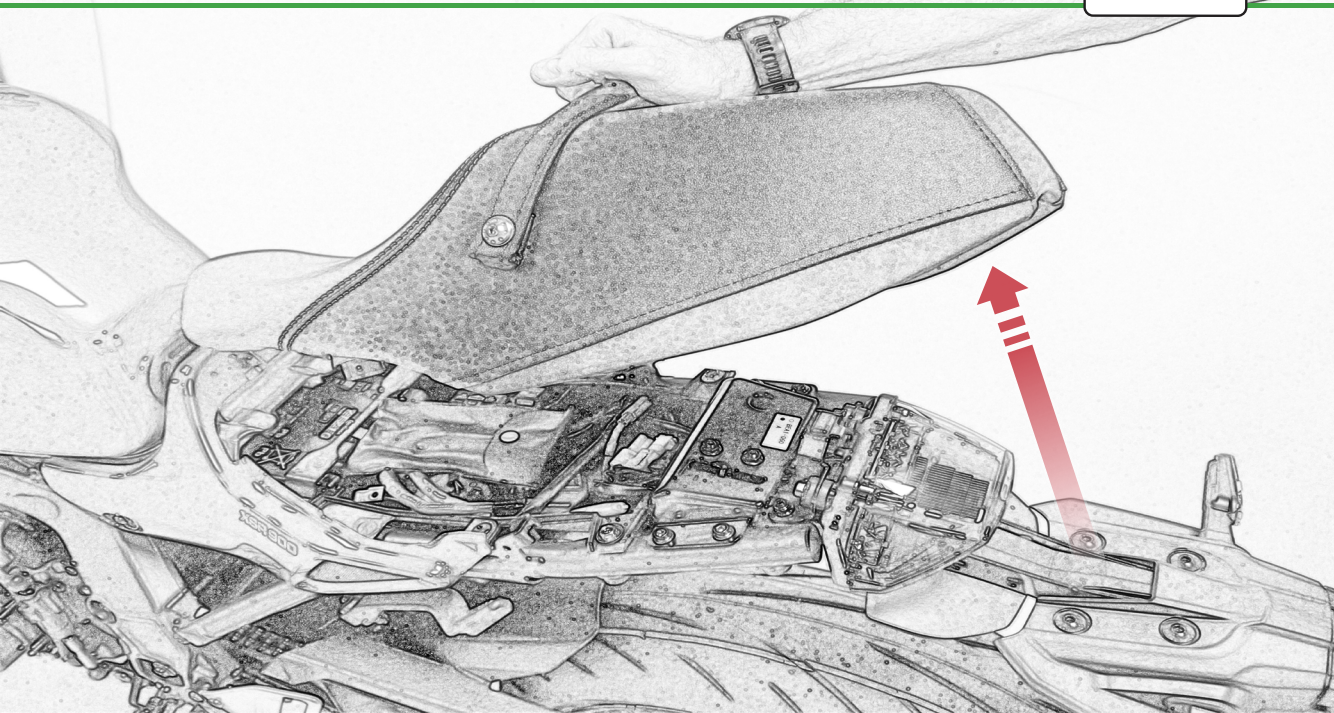

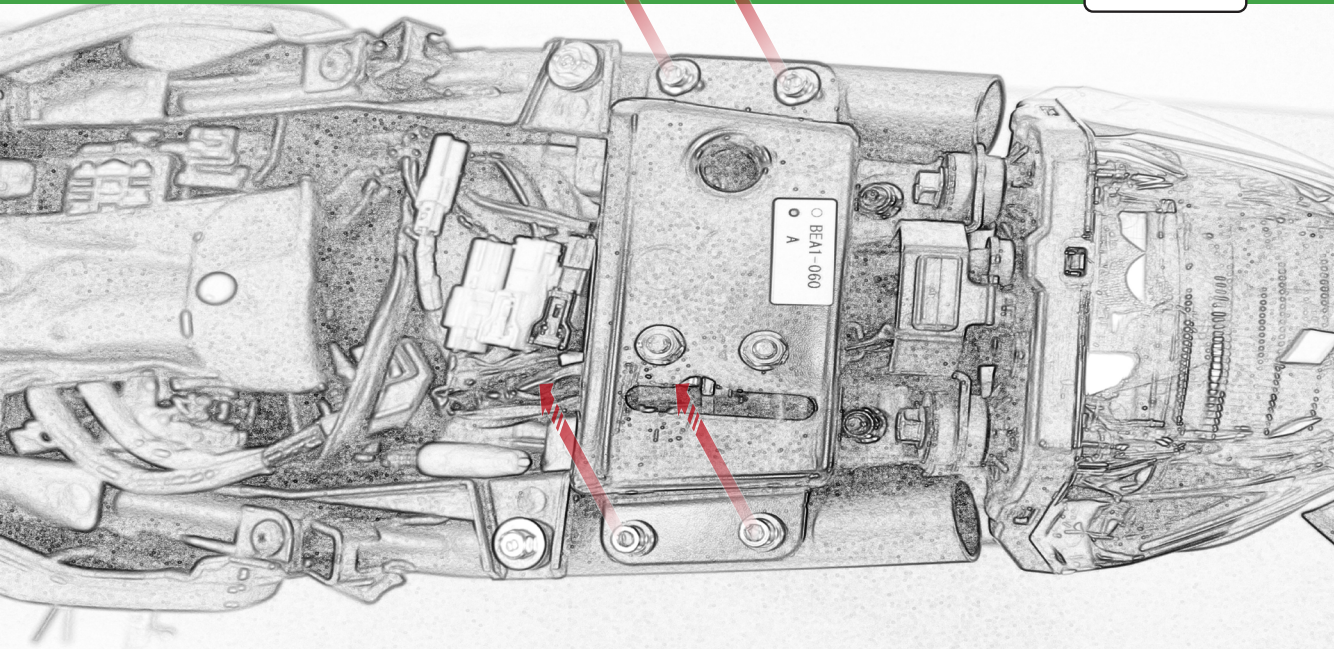

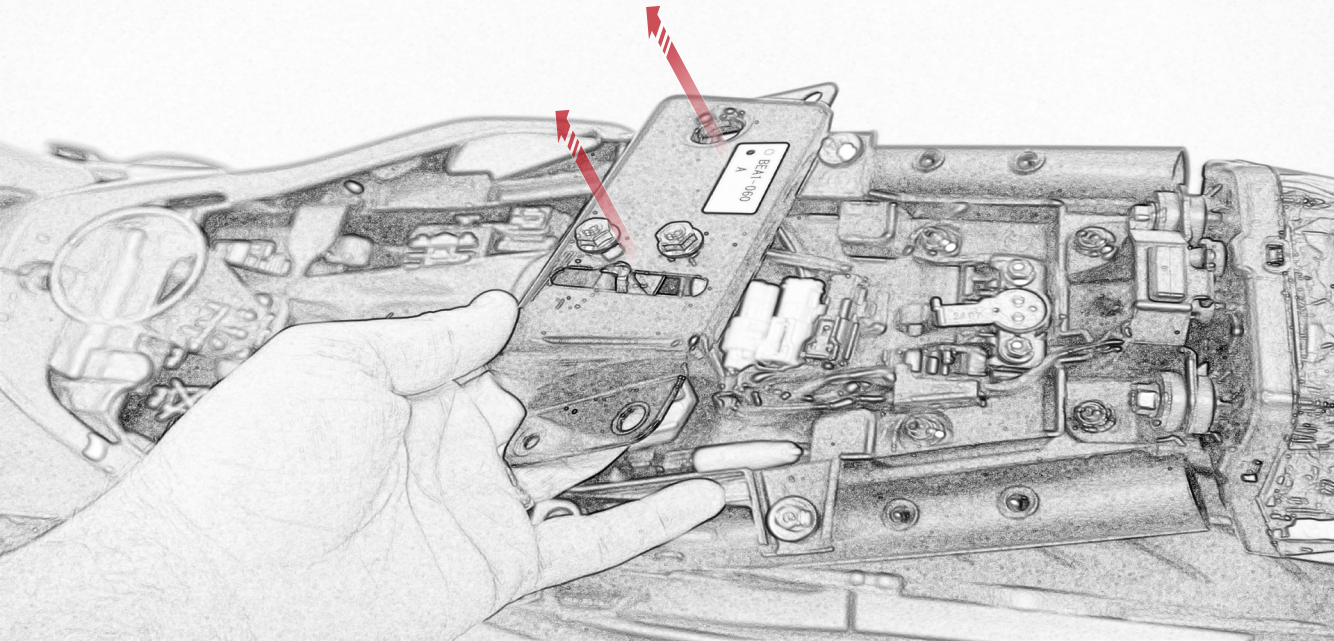

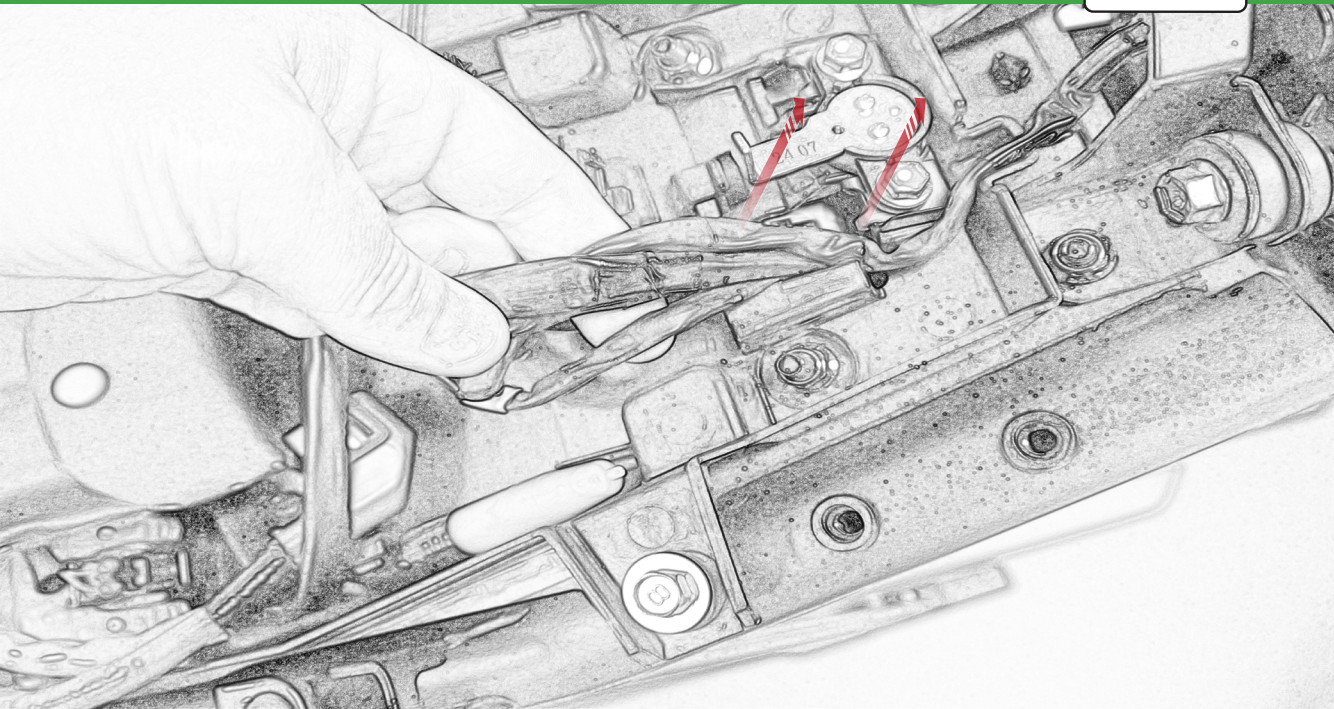

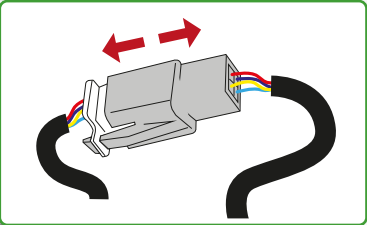
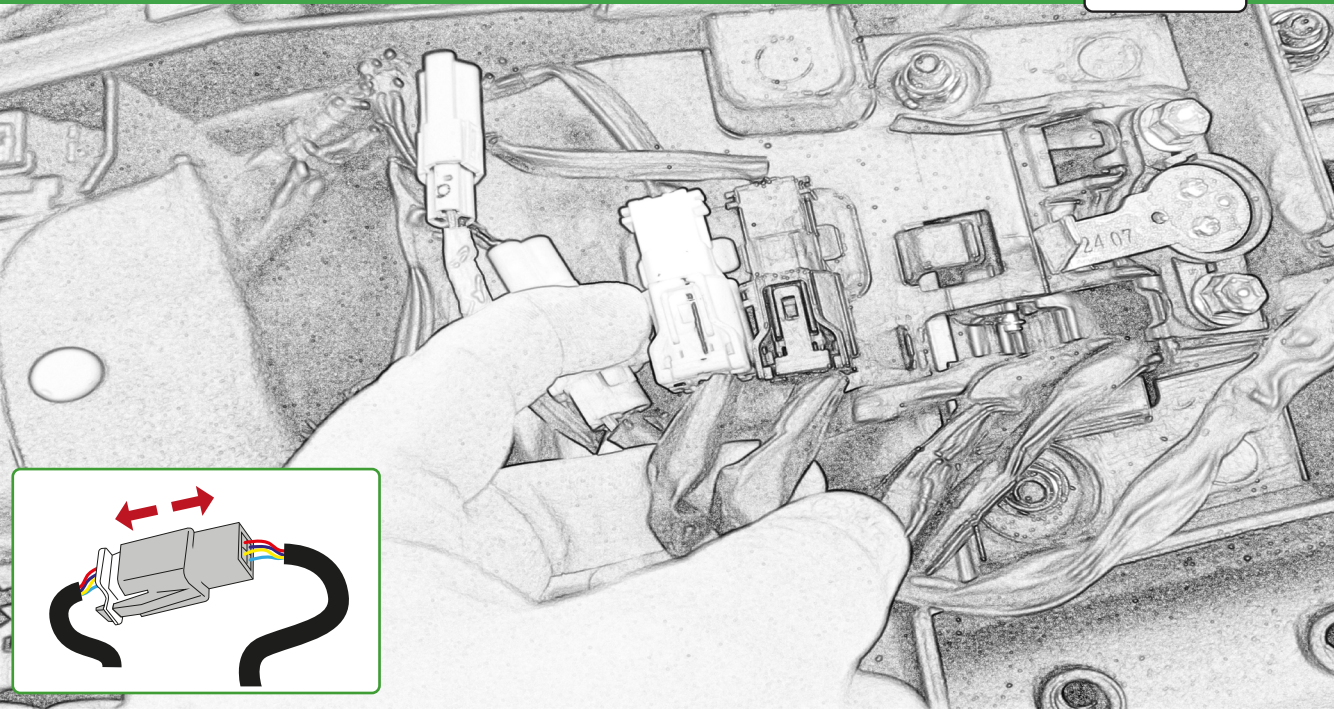

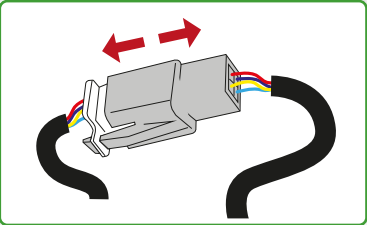
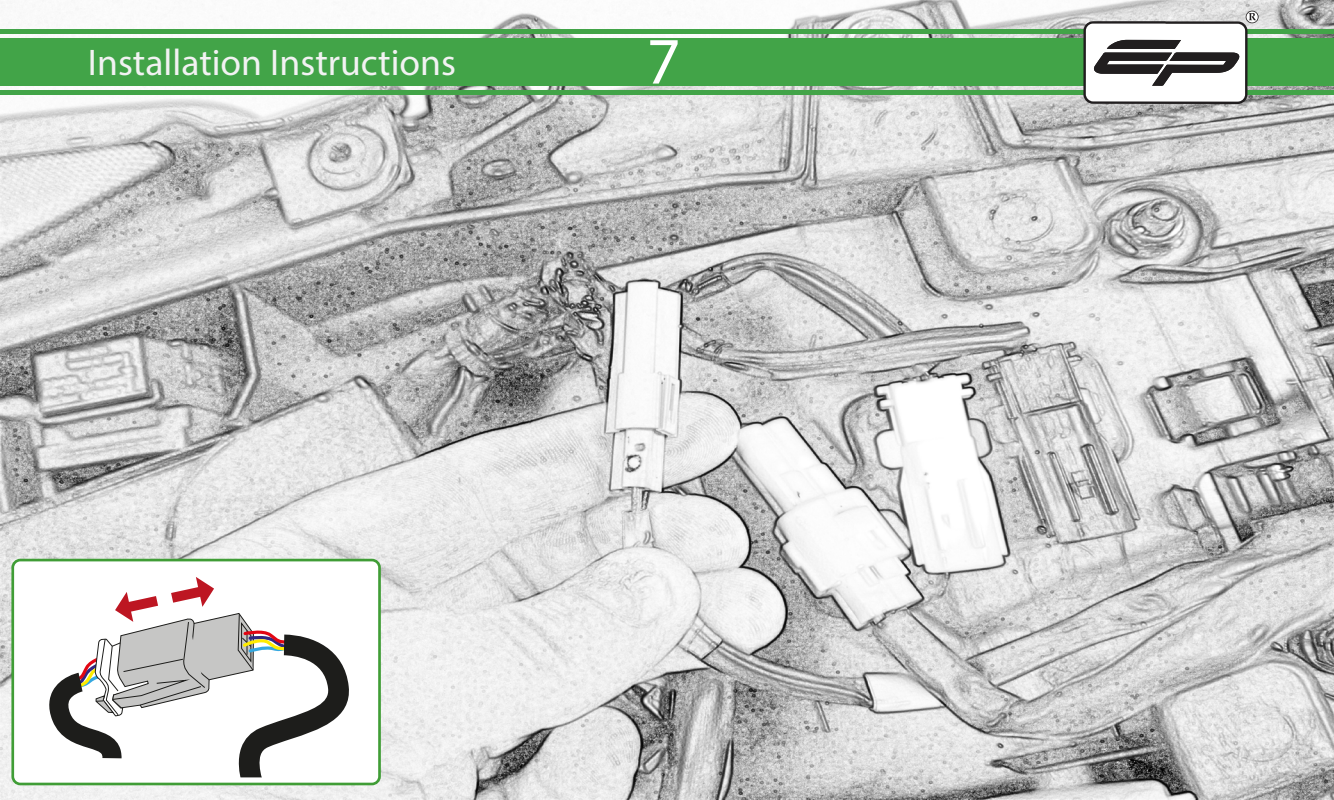

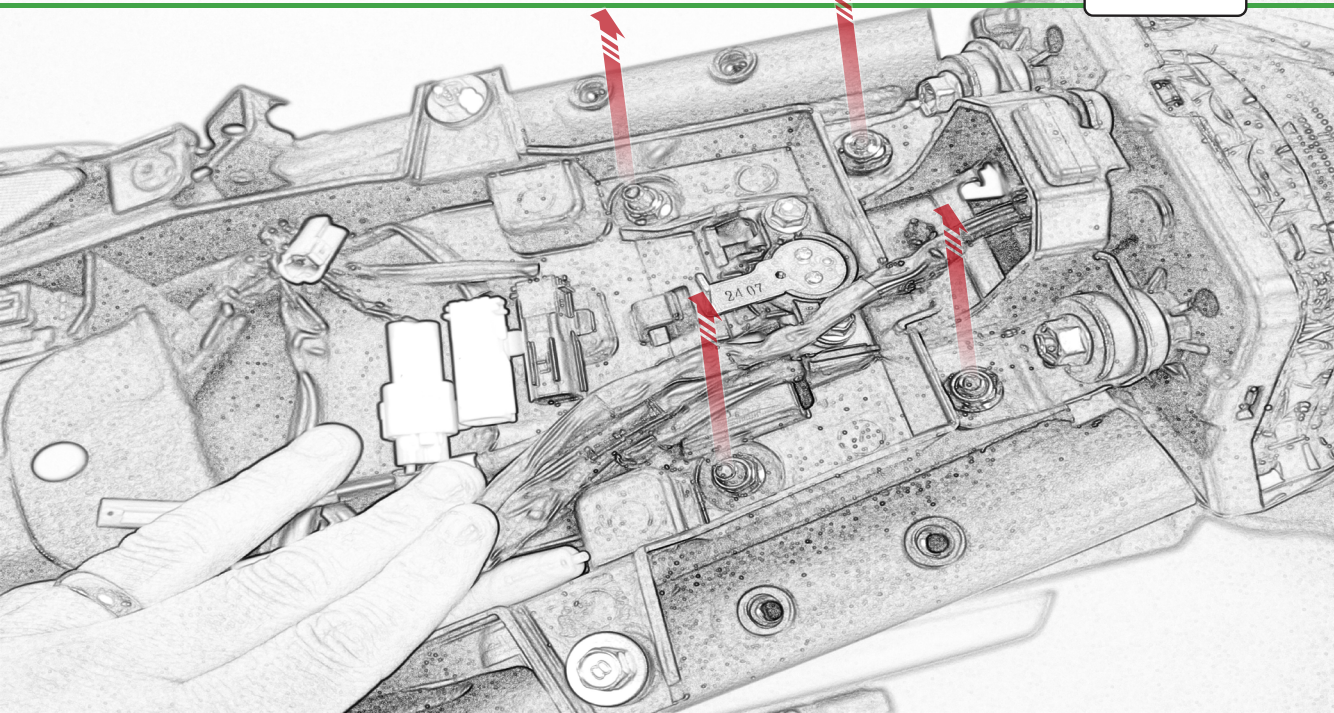

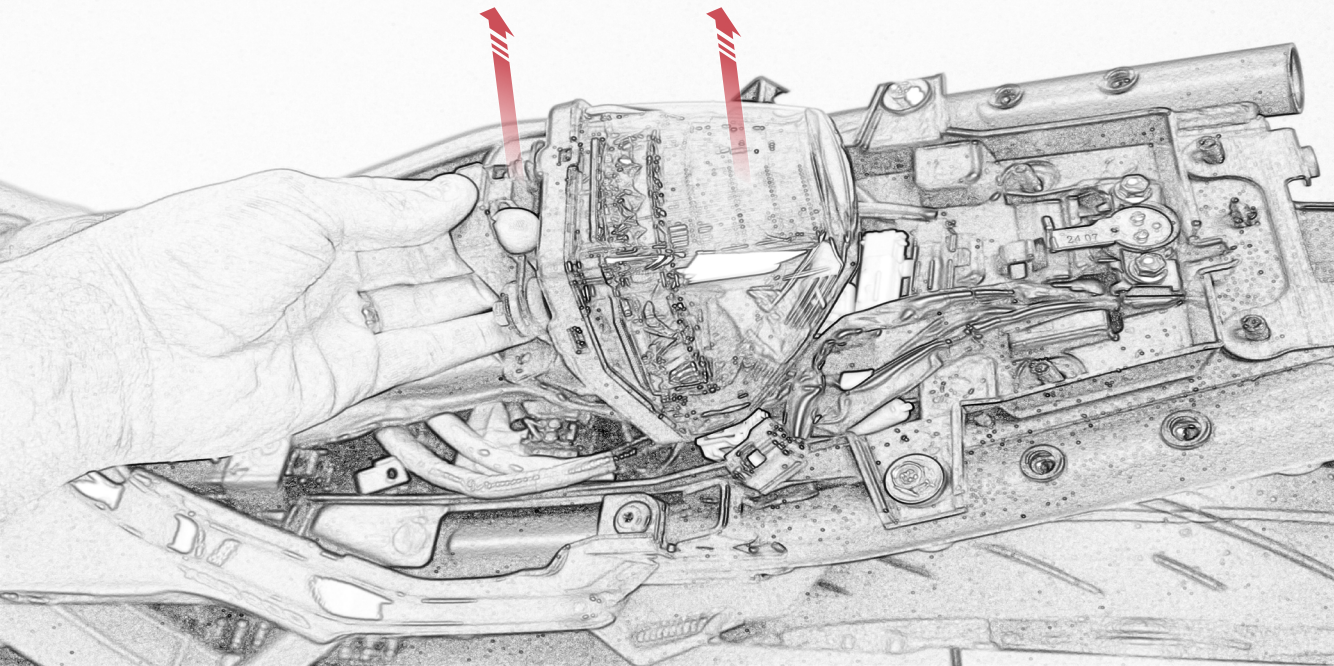

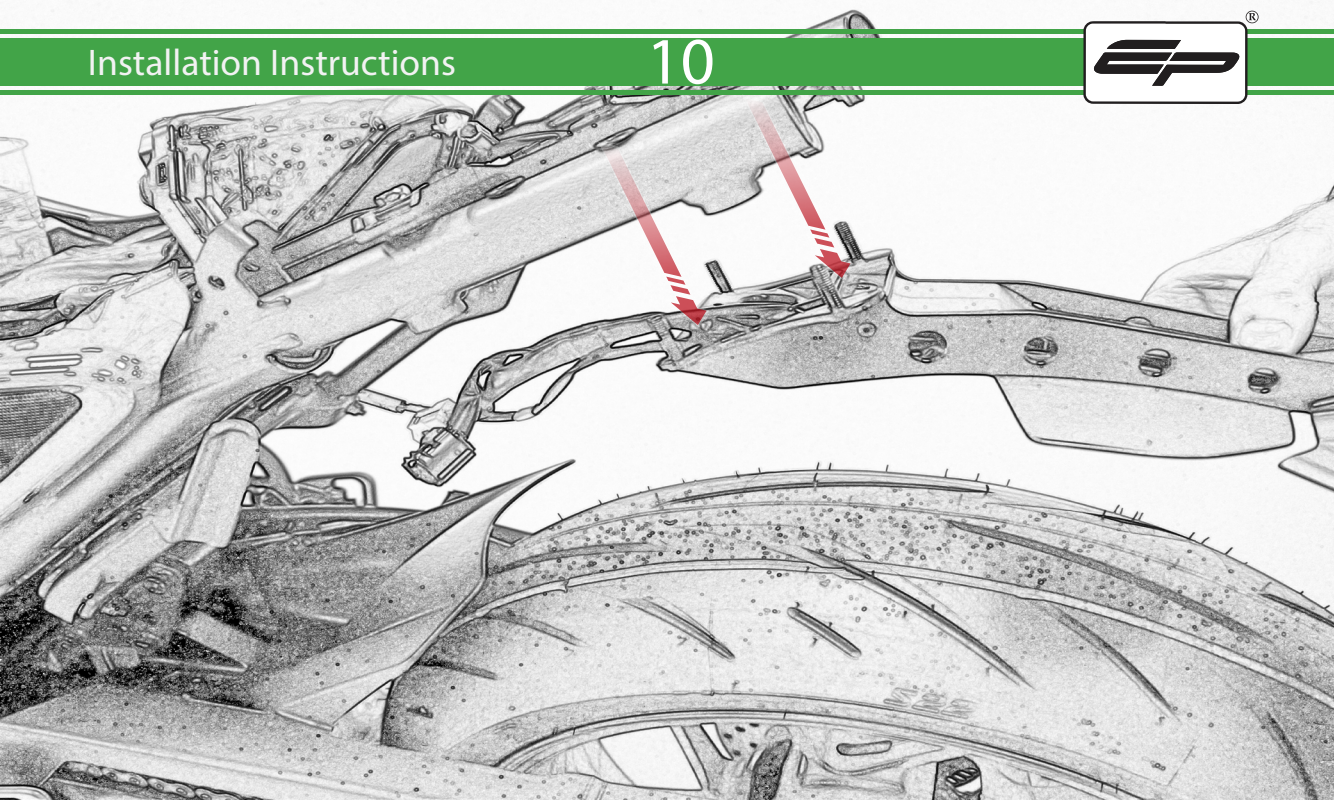

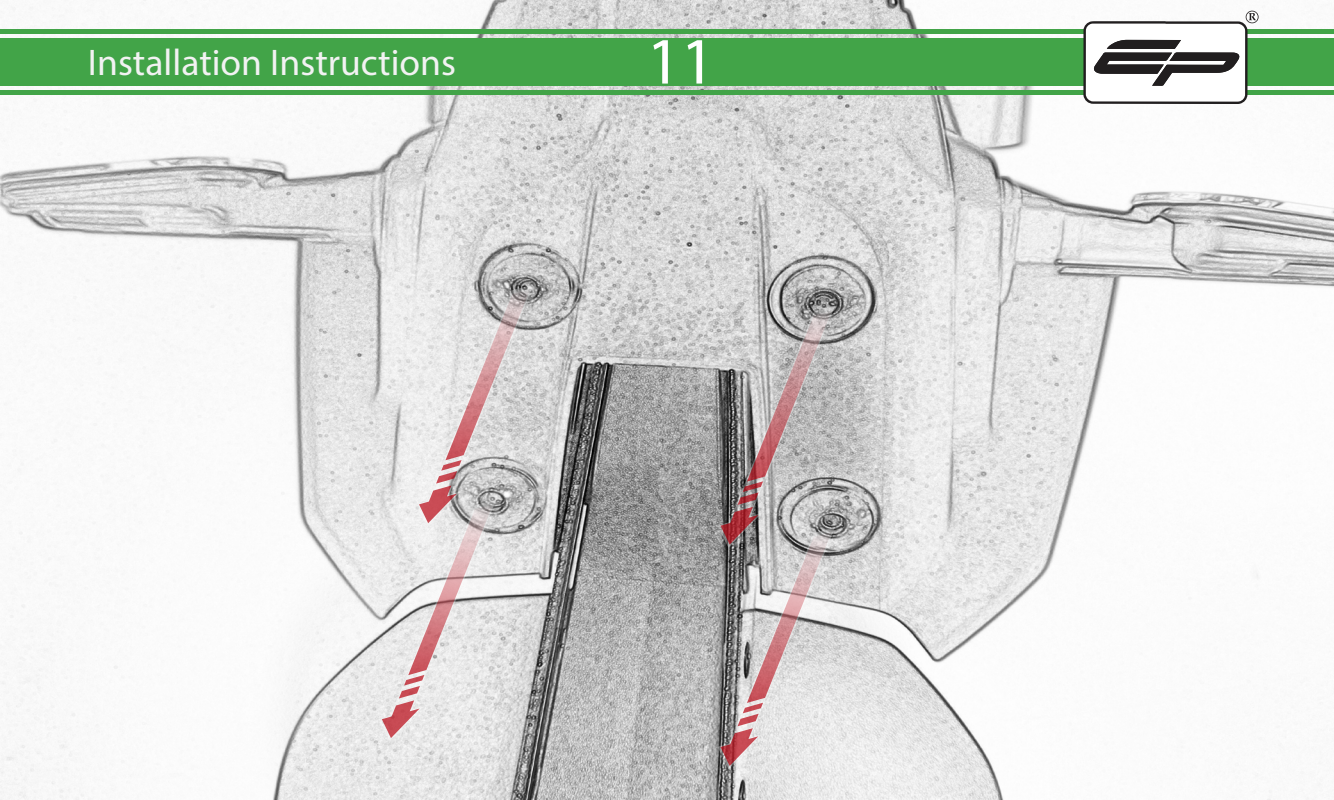

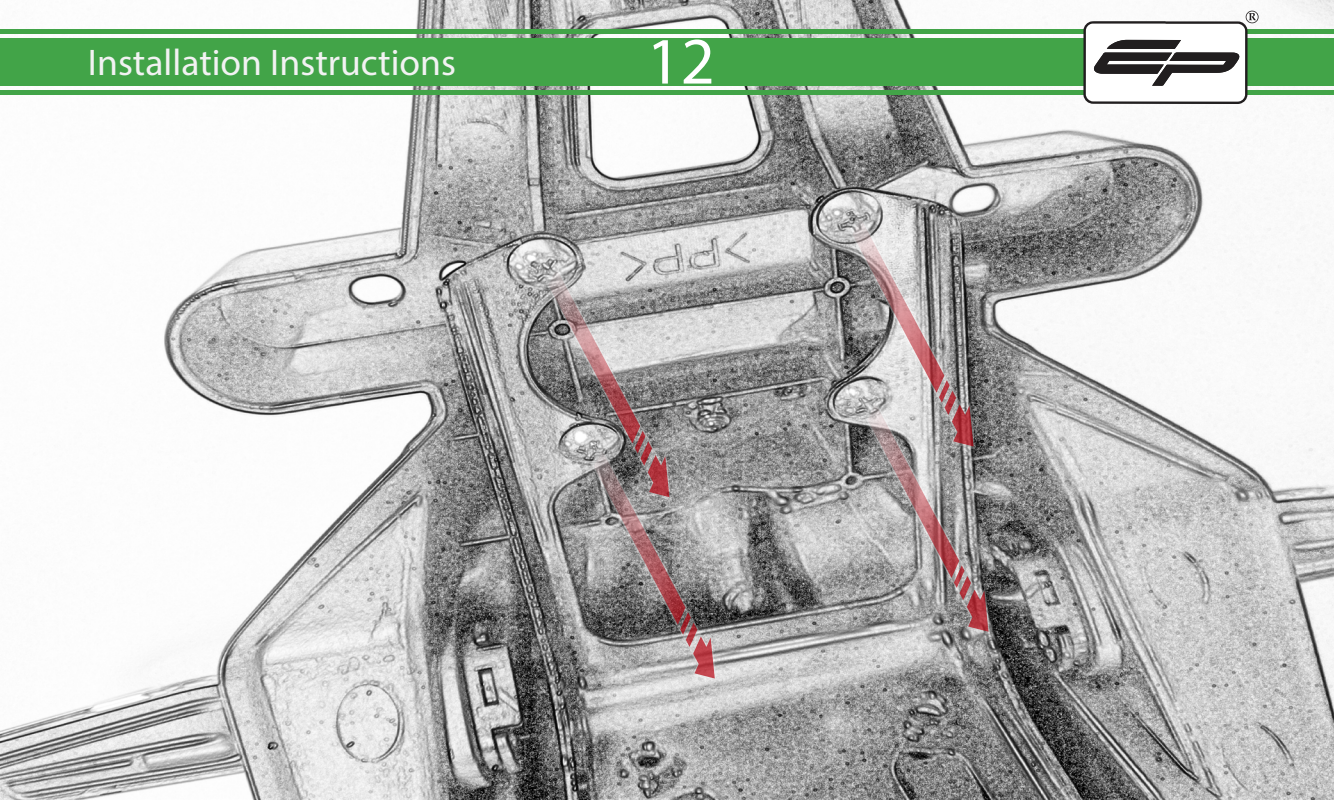

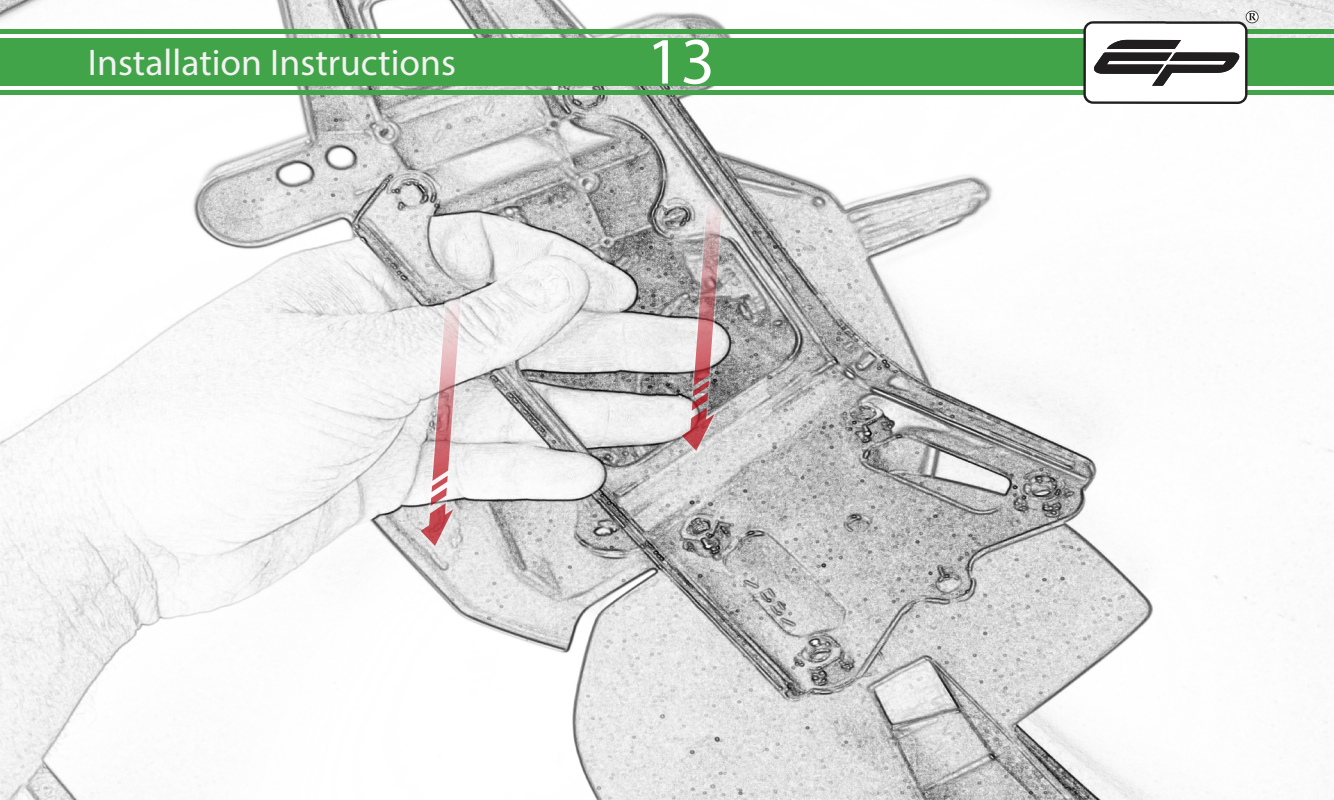

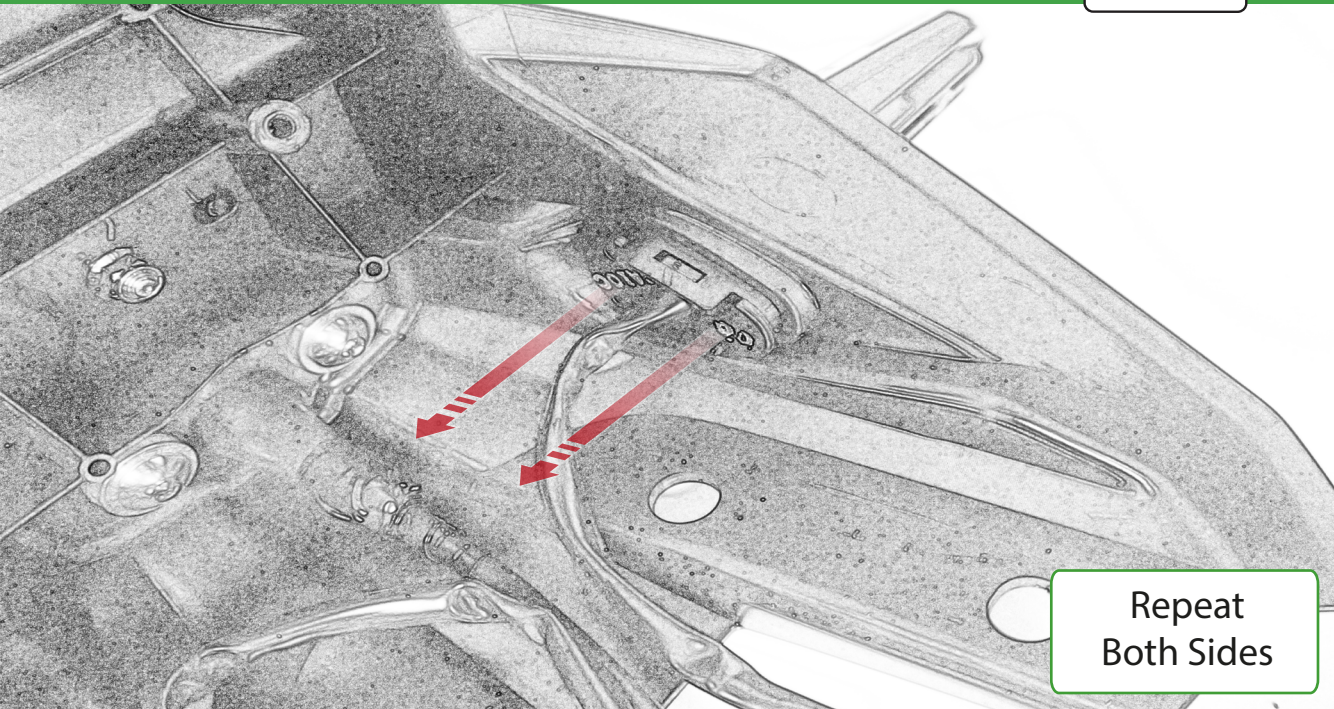

Repeat
Both Sides

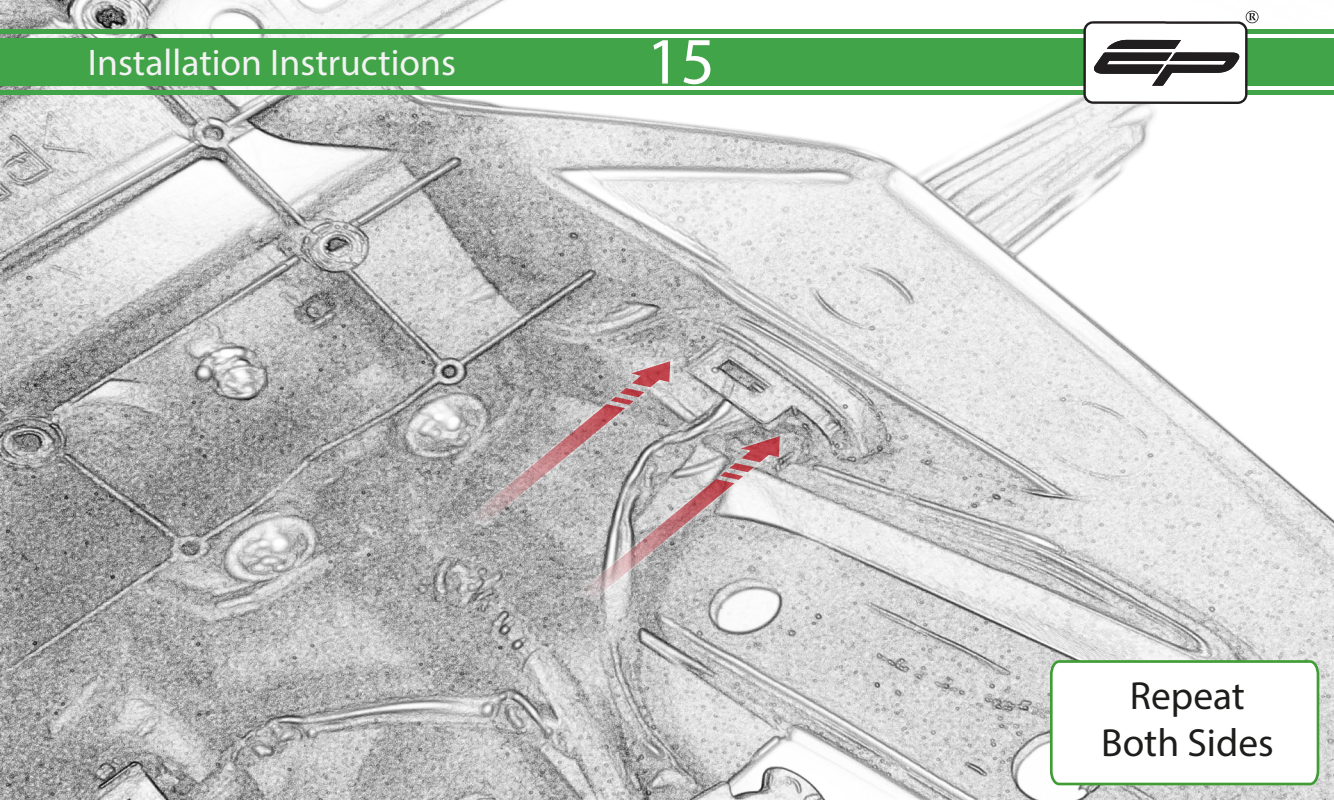

Repeat
Both Sides

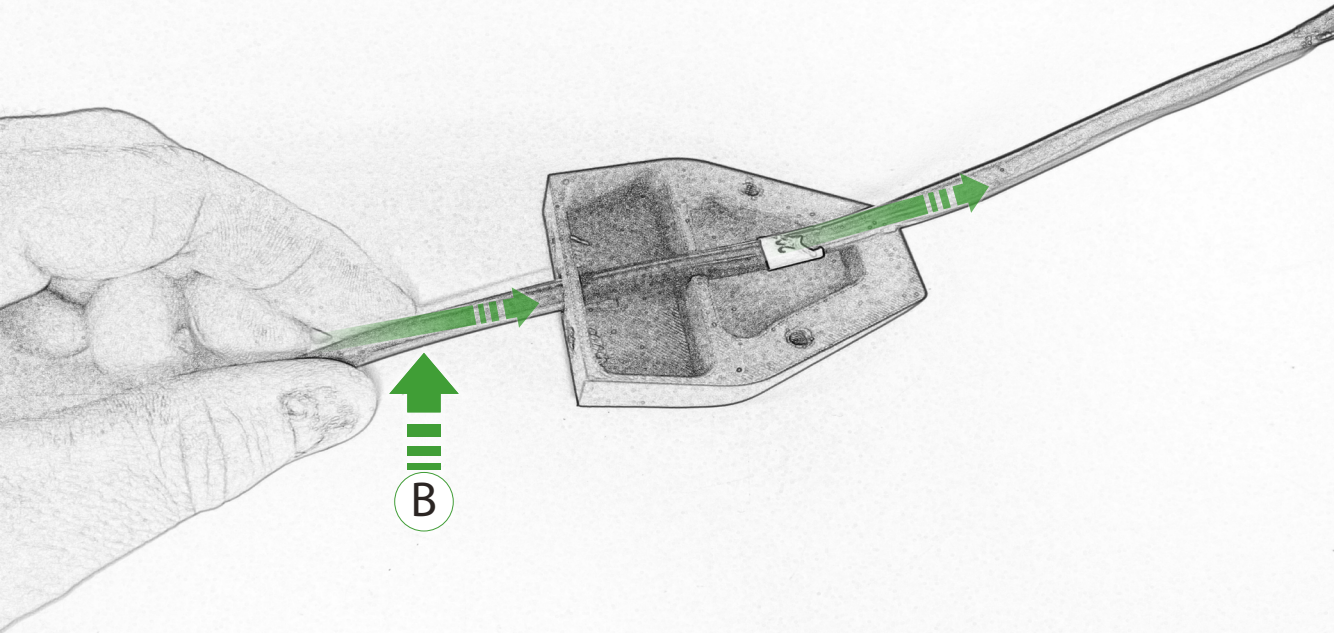

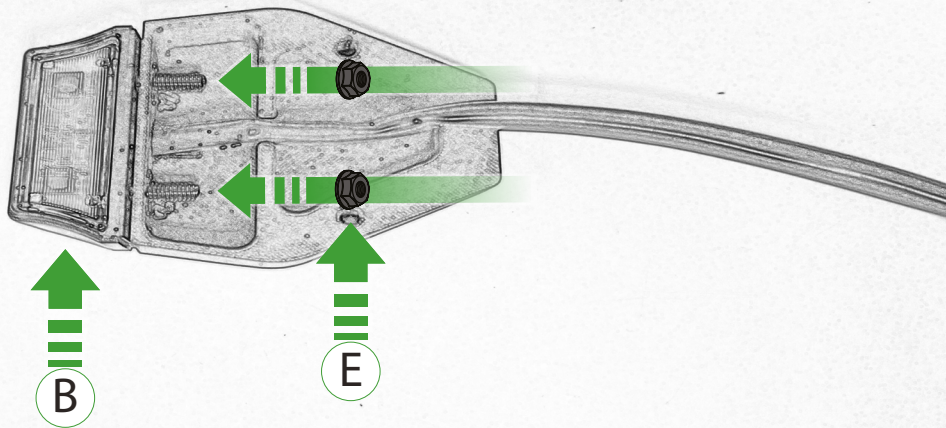

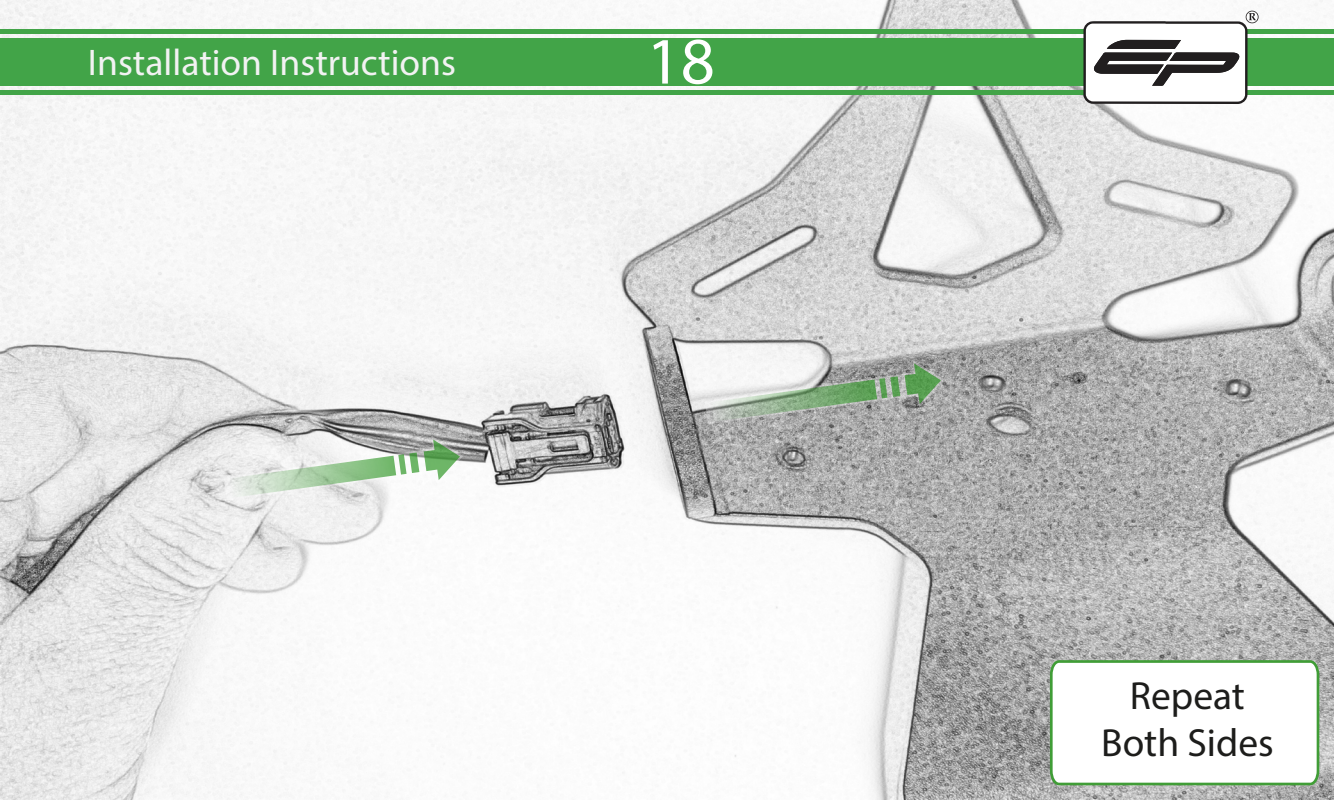

Repeat
Both Sides

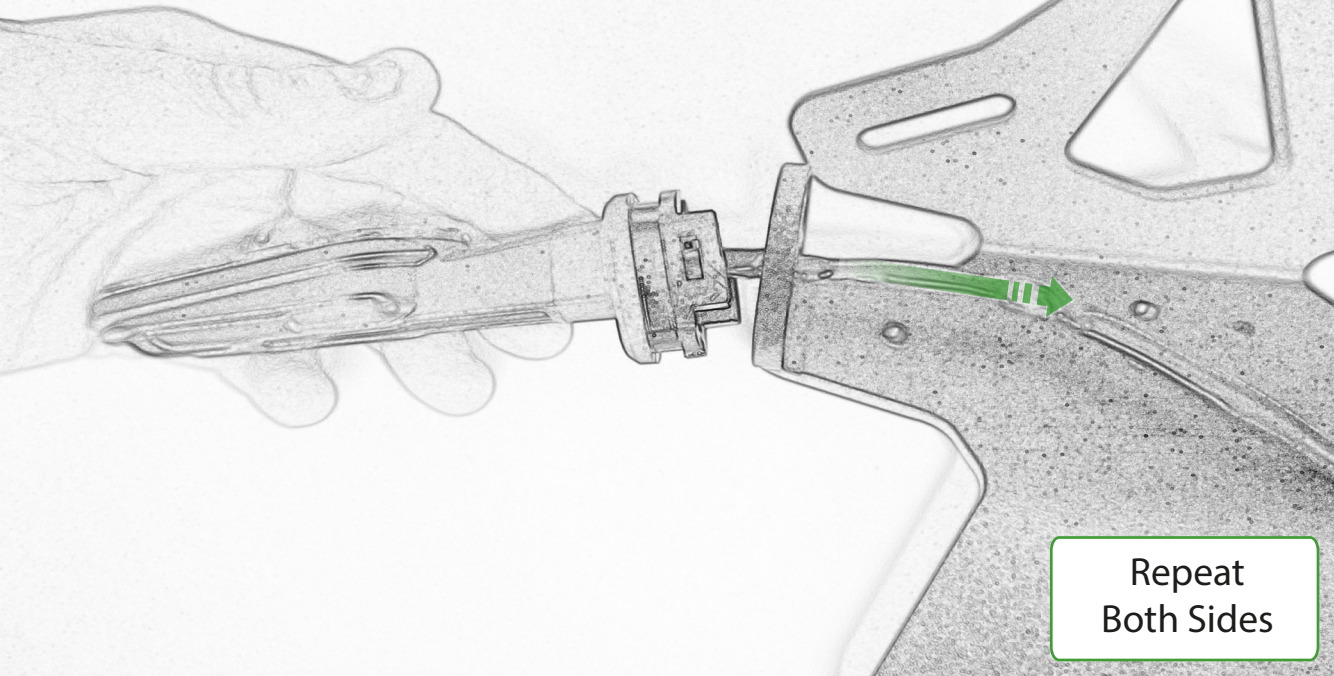

Repeat
Both Sides

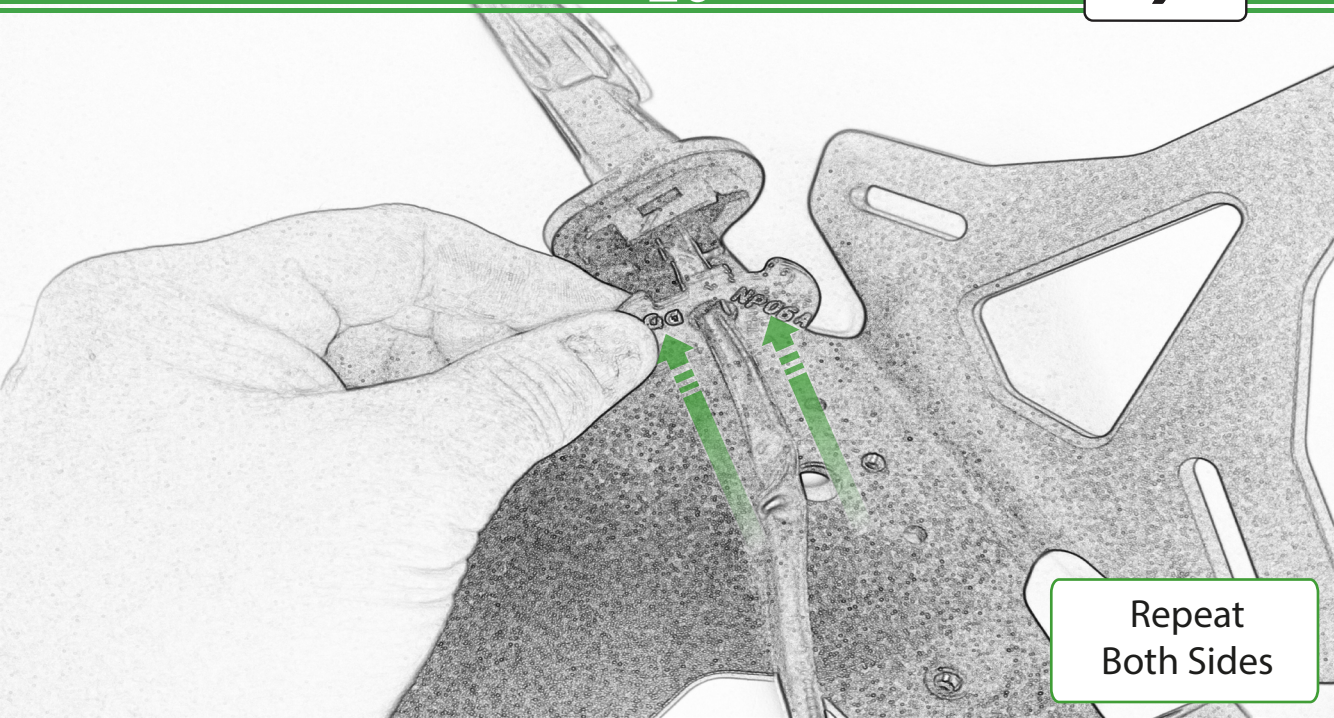

Repeat
Both Sides

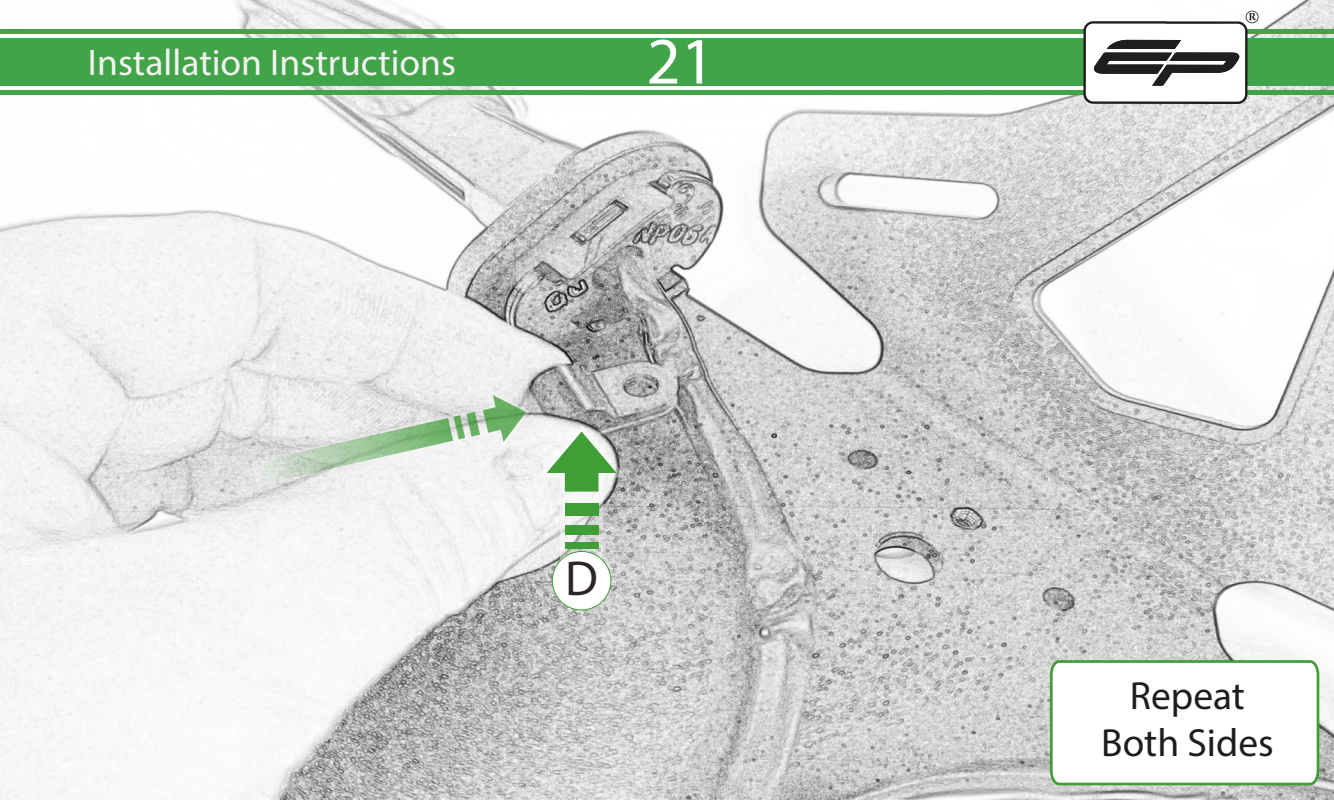

Repeat
Both Sides

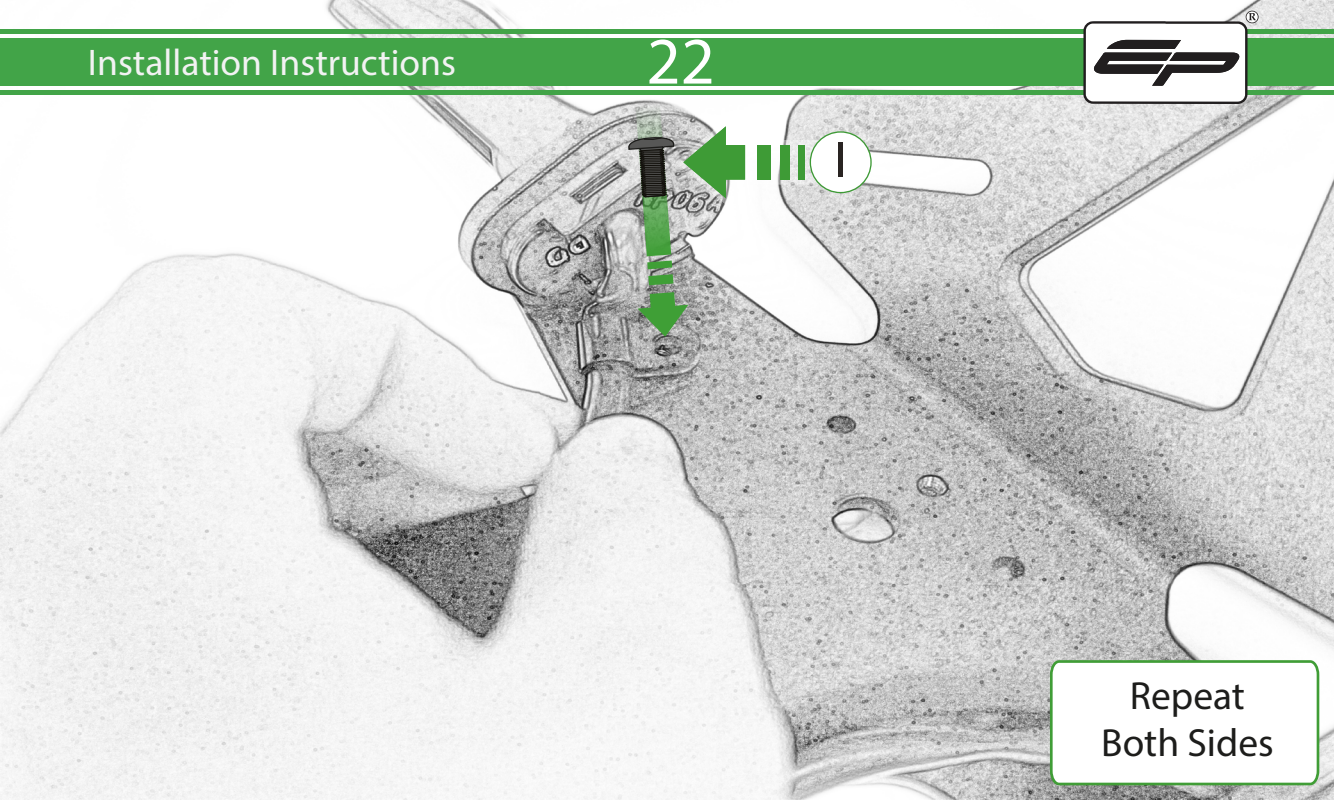

Repeat
Both Sides

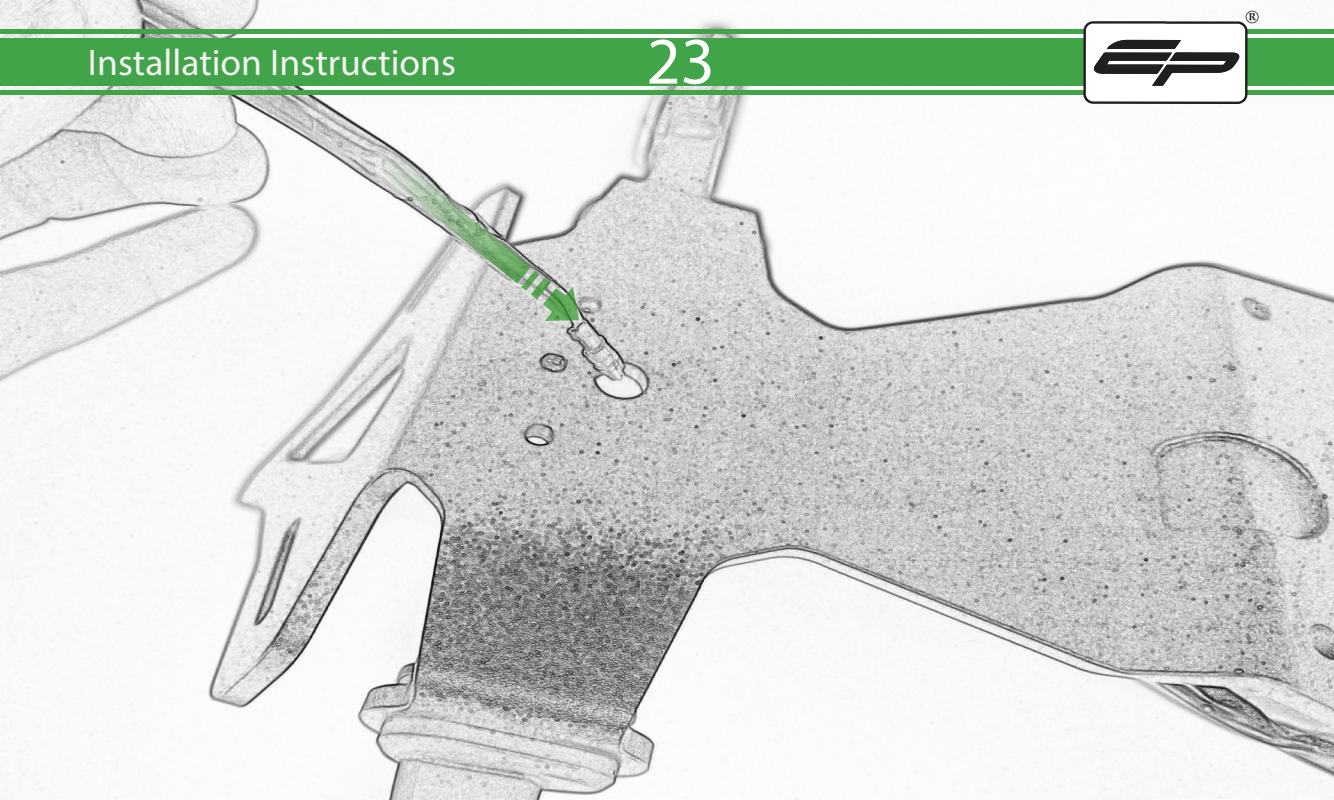

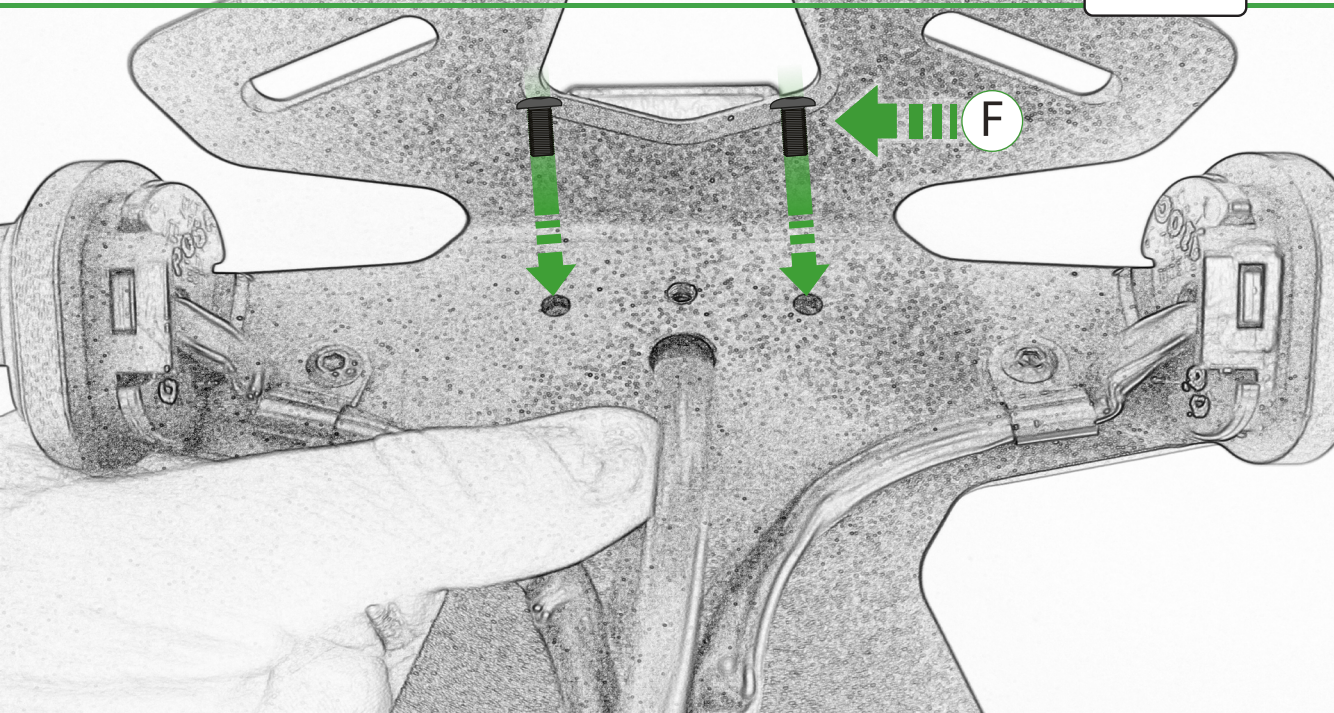

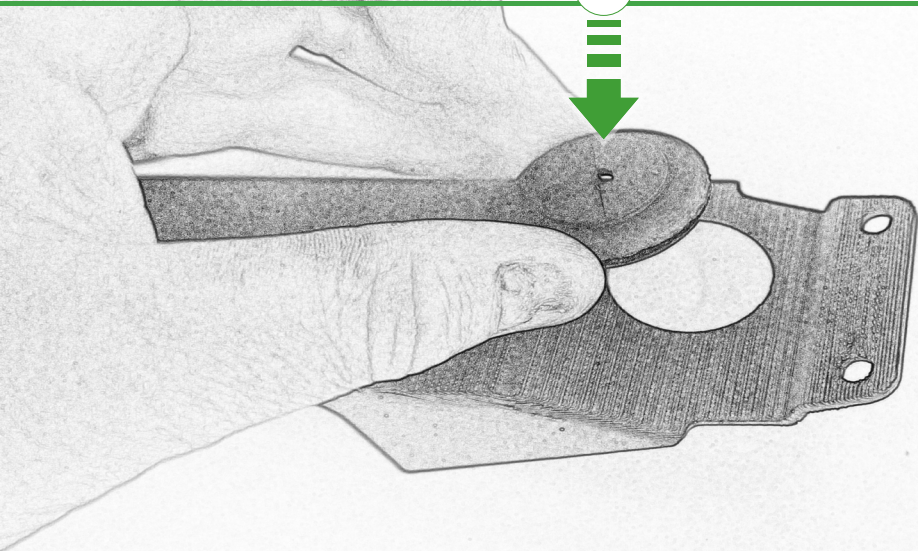

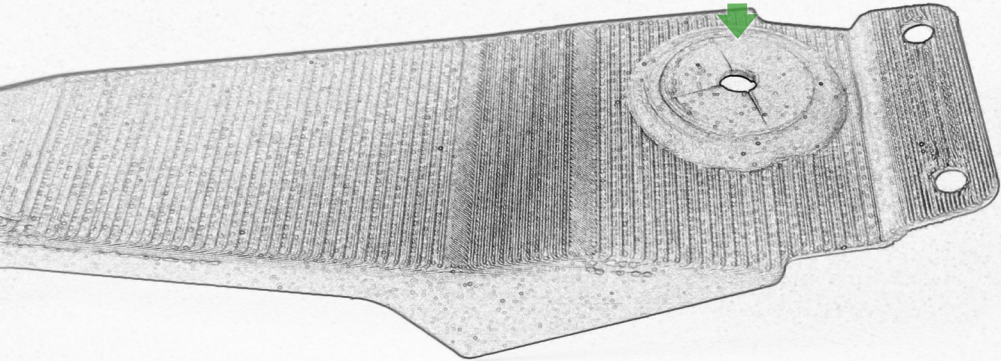

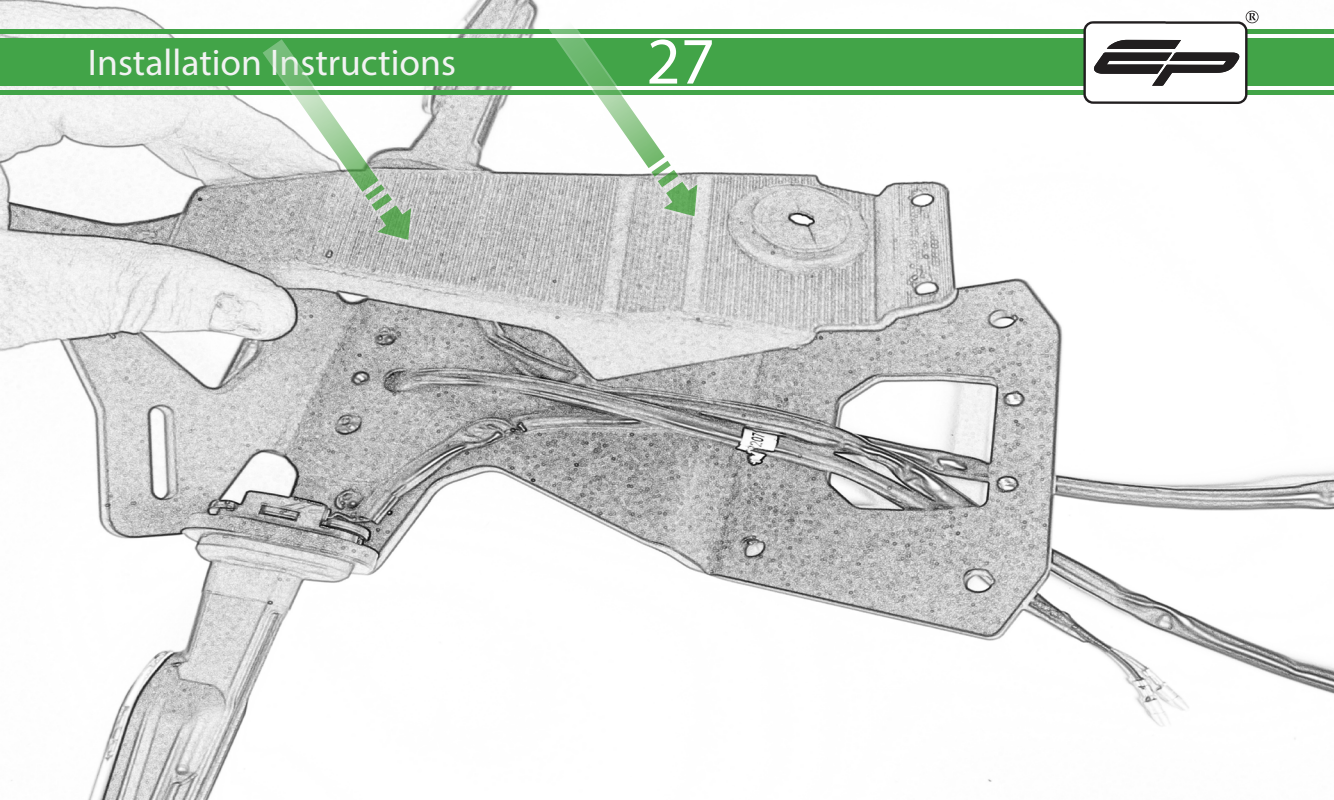

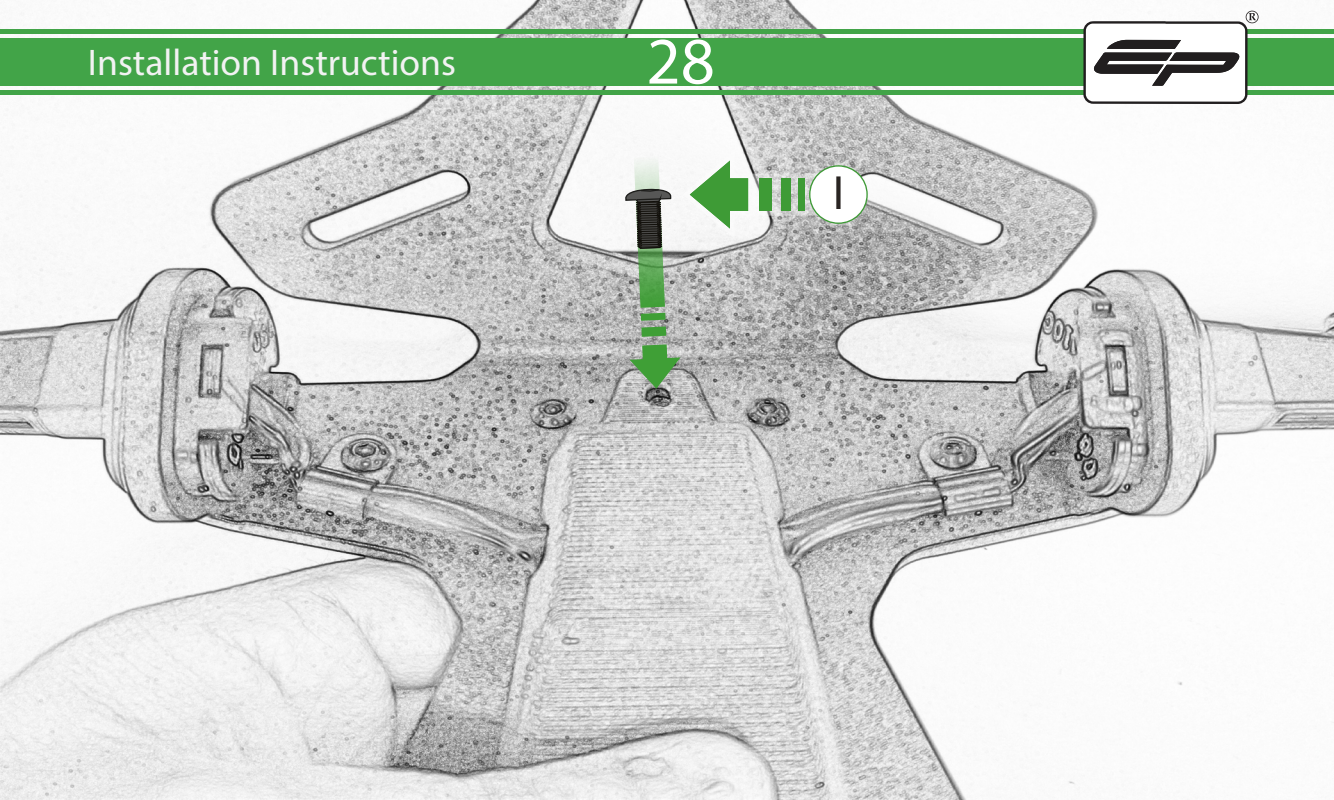

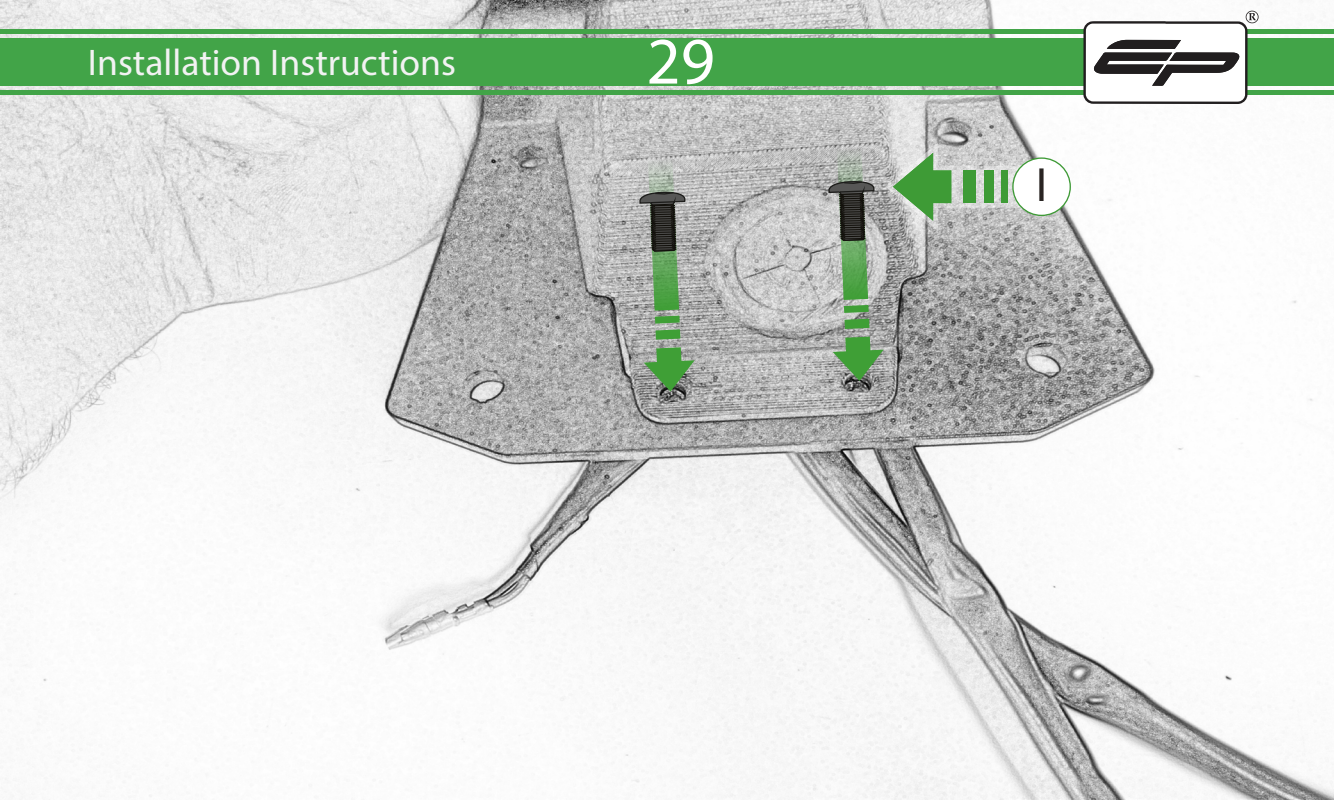

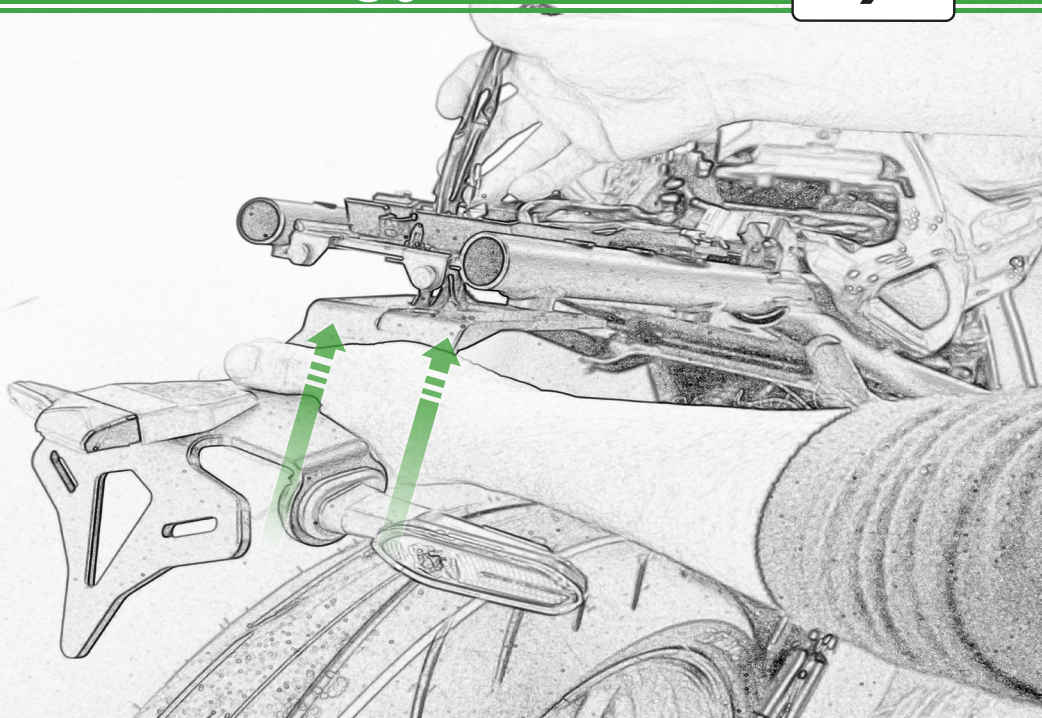

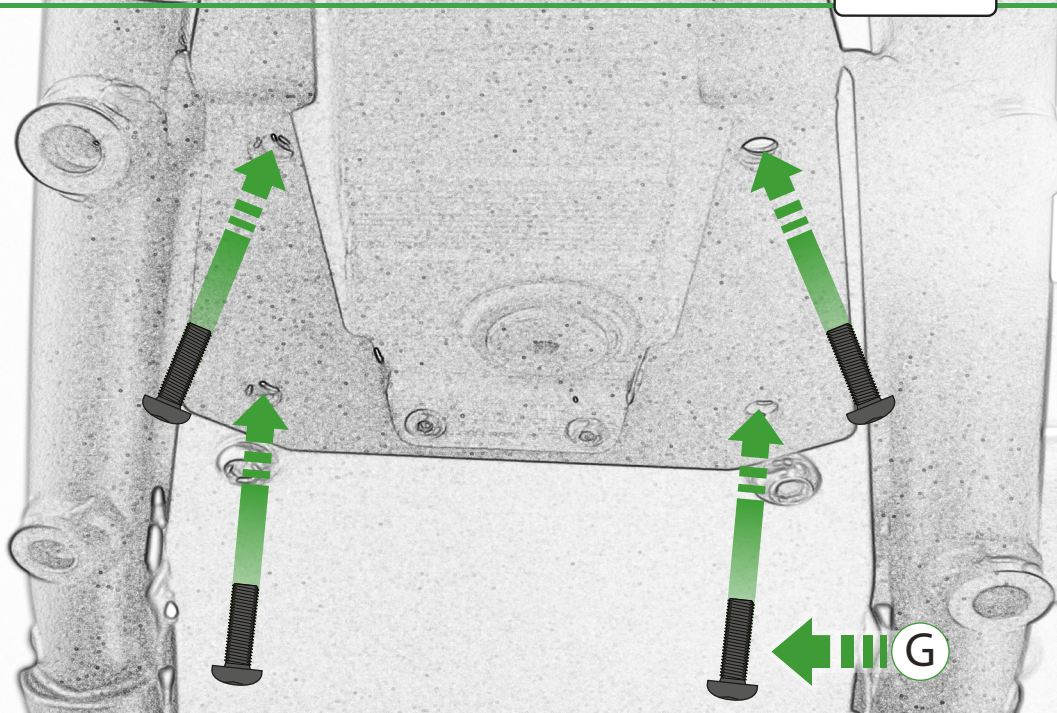

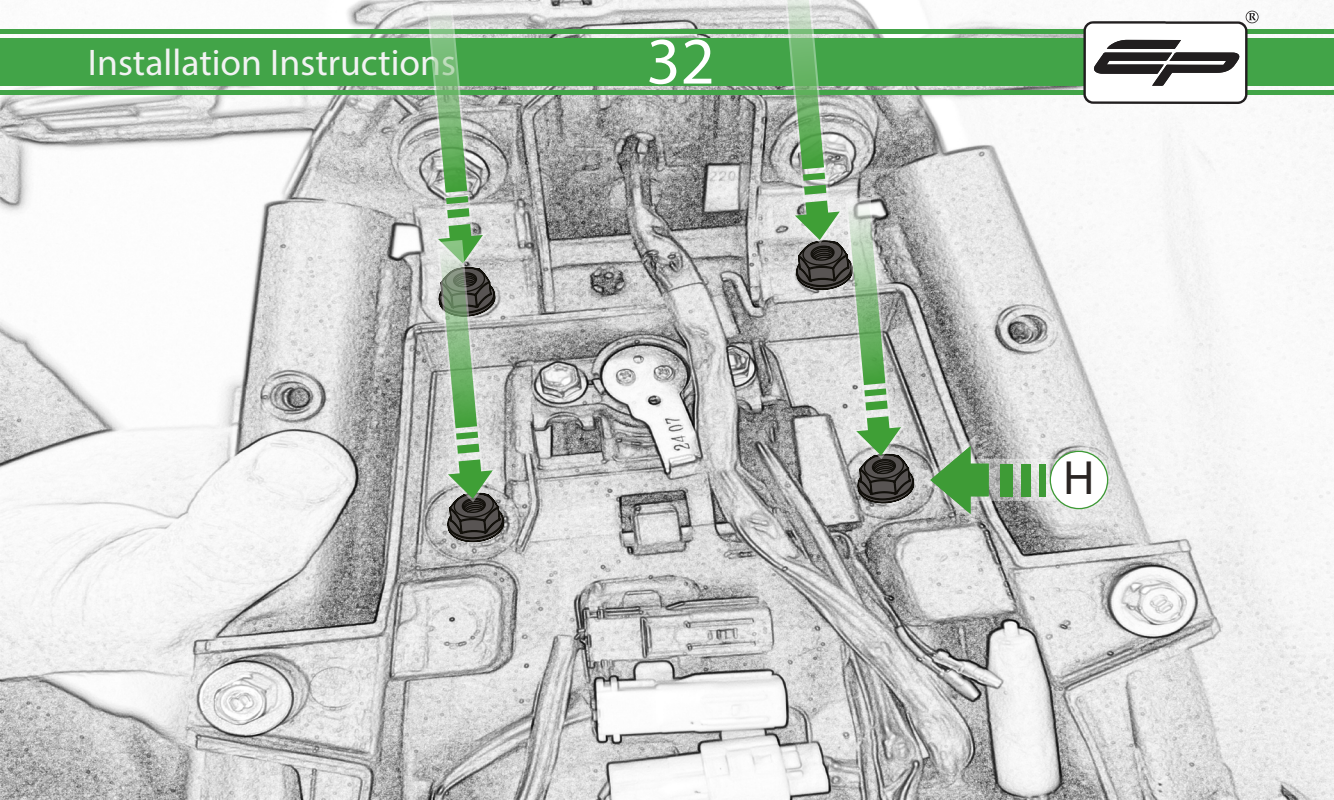

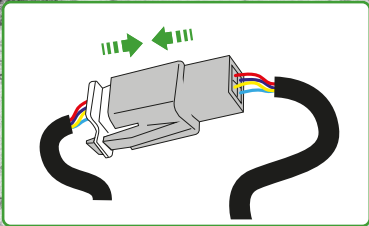
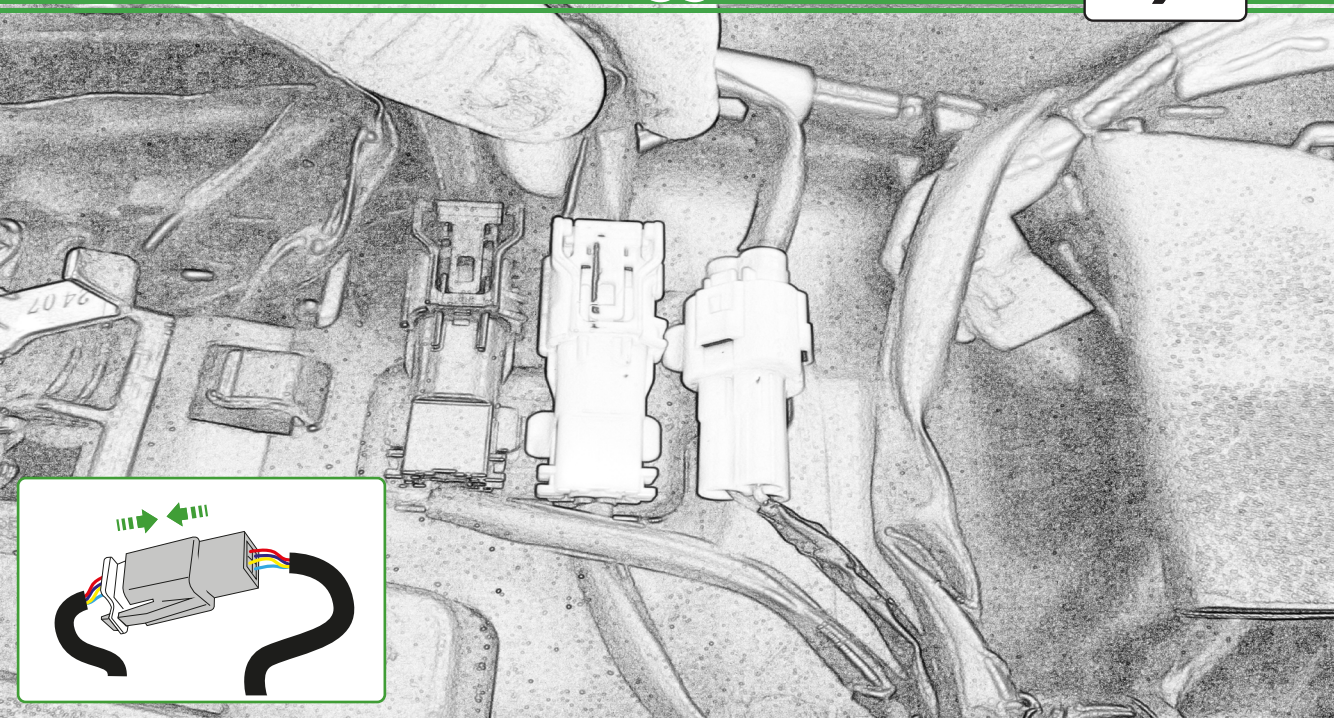

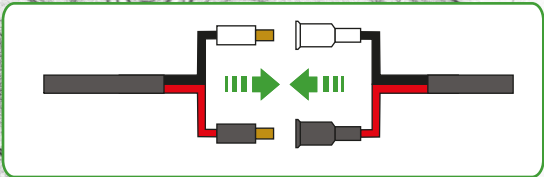
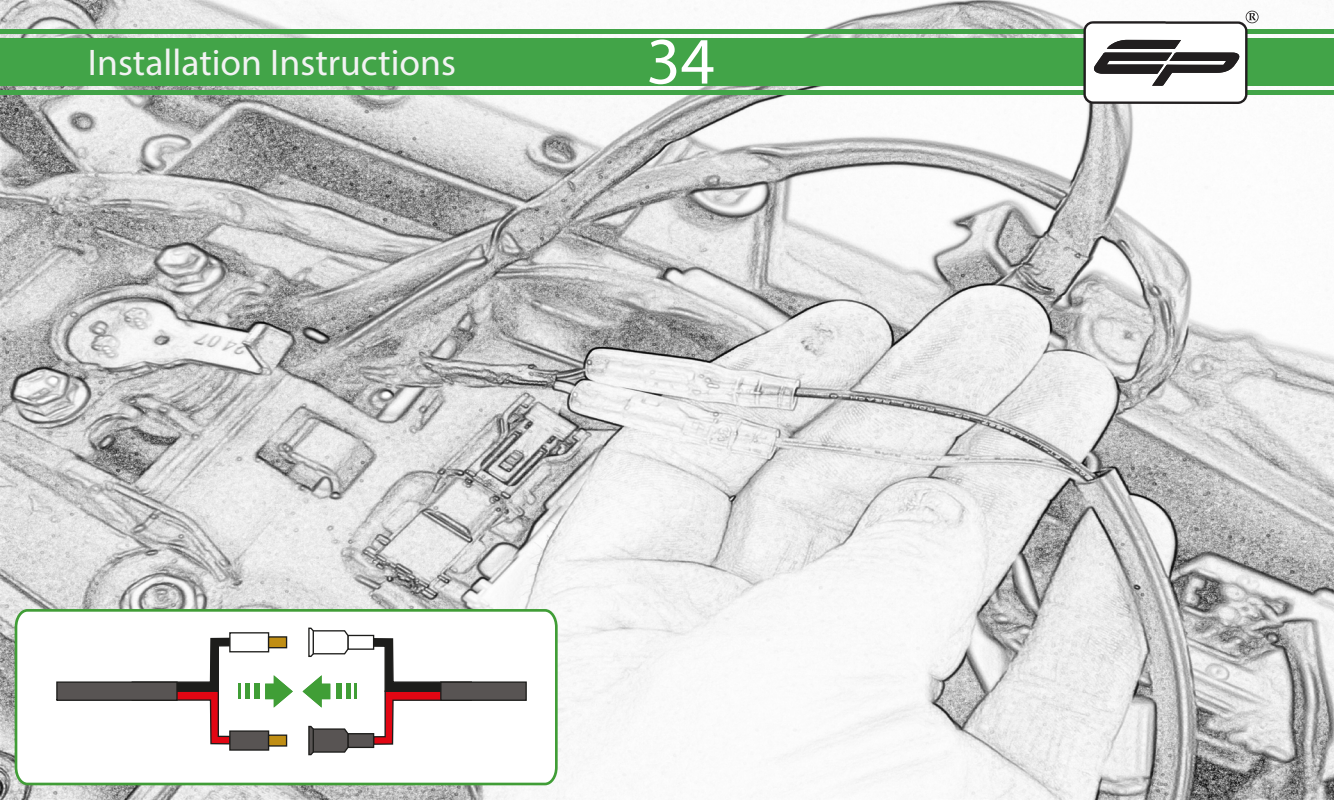

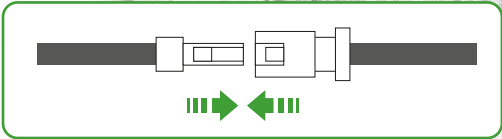
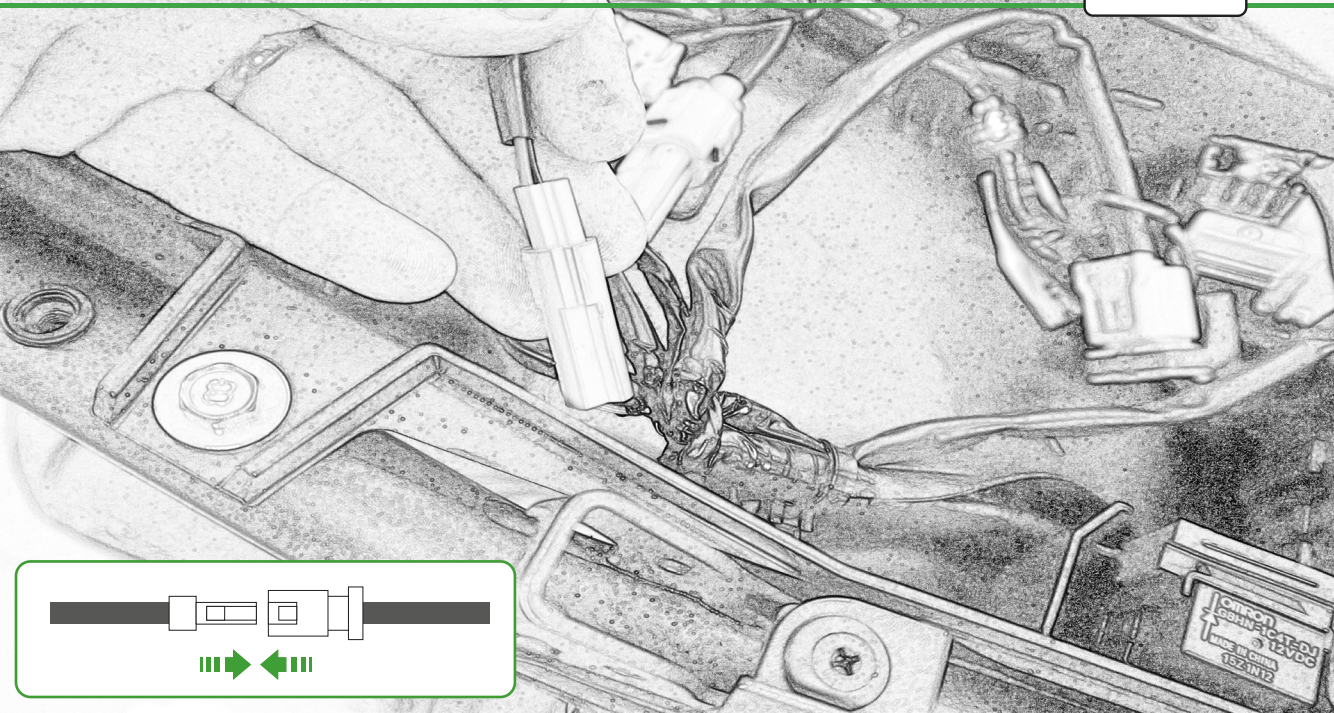



EVOTECH[®]
P E R F O R M A N C E



ESSENTIAL CHECKS



After installation of your tail tidy ensure that the licence plate does not contact the rear tyre when suspension is fully compressed.

Ensure all electrics including indicators, tail light, brake light and licence plate light lights are working correctly before riding the motorcycle.

It is recommended that periodic inspections are made to ensure that all fixings are fully tightened.

EVOTECH[®]
PERFORMANCE

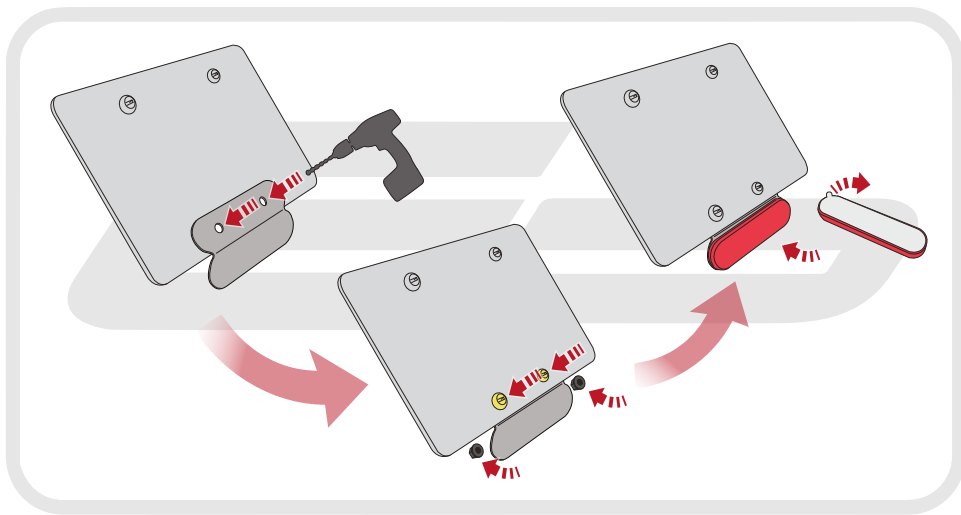

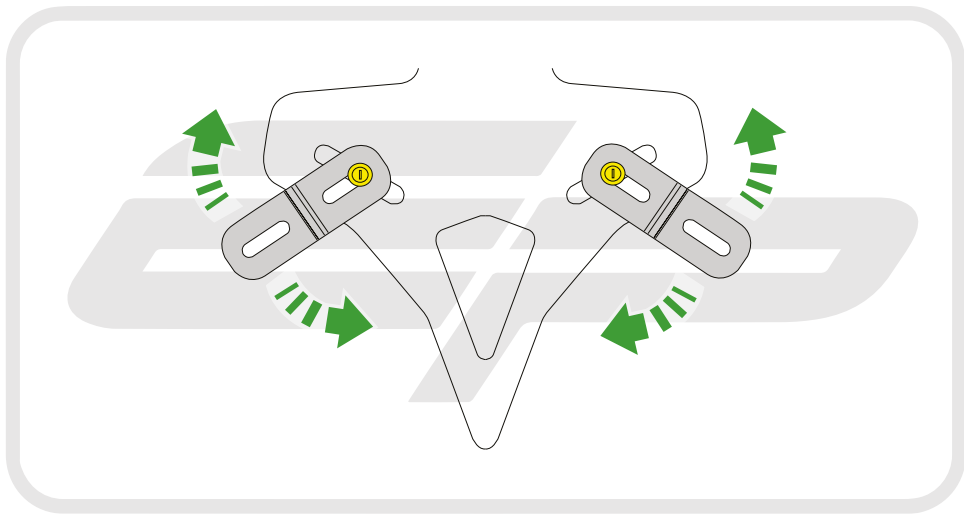



EVOTECH®
P E R F O R M A N C E

www.evotech-performance.com