



**EVOTECH**®  
P E R F O R M A N C E

[www.evotech-performance.com](http://www.evotech-performance.com)

Yamaha Tracer 7 Garmin Sat Nav  
Installation Instructions



## Kit Contents PRN014566-015832

- (A) 1 x Main Plate
  - (B) 1 x Pivot Plate
  - (C) 1 x Sub Mounting Bracket
  - (D) 2 x M5 x 8mm Black Button Head Bolts
  - (E) 2 x P-clips (No.1)
  - (F) 2 x P-clips (No.2)
  - (G) 2 x P-clips (No.3)
  - (H) 2 x P-clips (No.4)
  - (I) 2 x Lobe Screw
  - (J) 2 x M5 Black Washer
  - (K) 2 x Locking Washer
  - (L) 2 x M4 x 5mm Black Button Head Bolts
  - (M) 4 x M4 x 10mm Black Button Head Bolts
- Sub Kit
- (N) 4 x Plastic Washers
  - (O) 4 x M5 x 25mm Black Button Bolt

EP PERFORMANCE

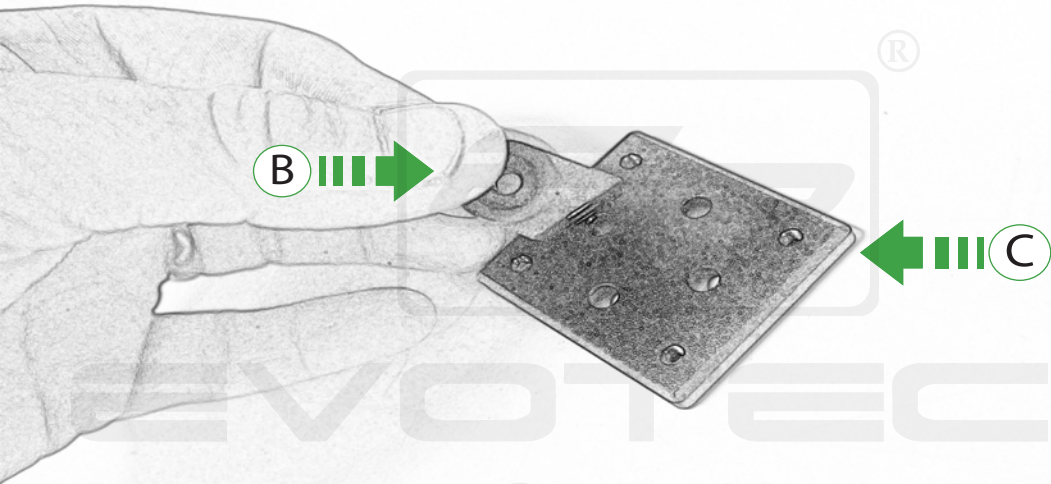

B



®



C

®

REVOTECH  
PERFORMANCE

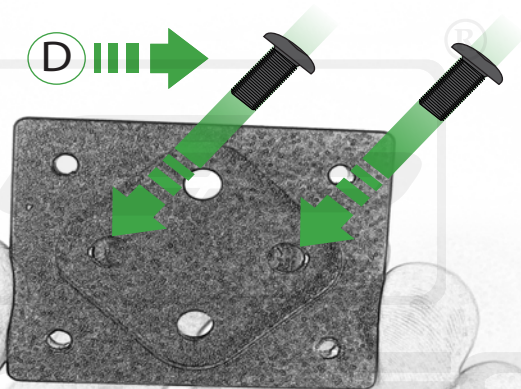

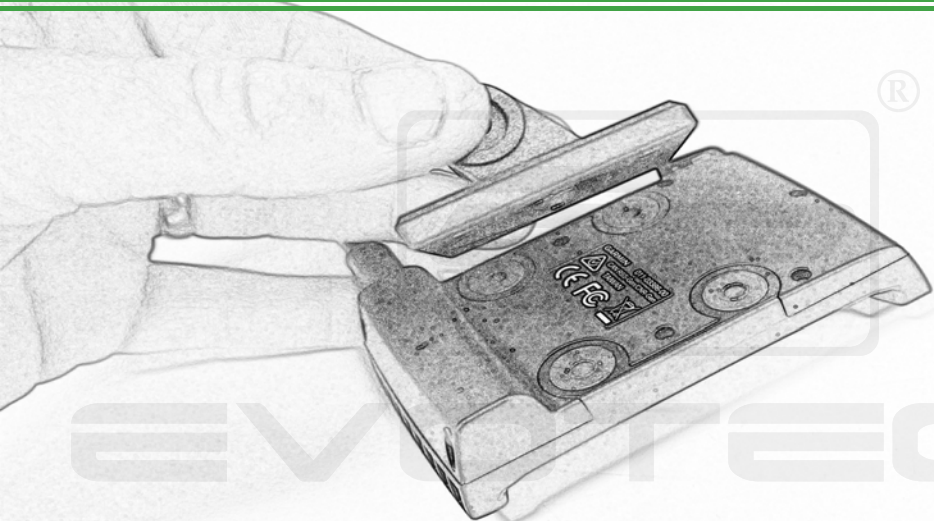

EVERTECH<sup>®</sup>

PERFORMANCE

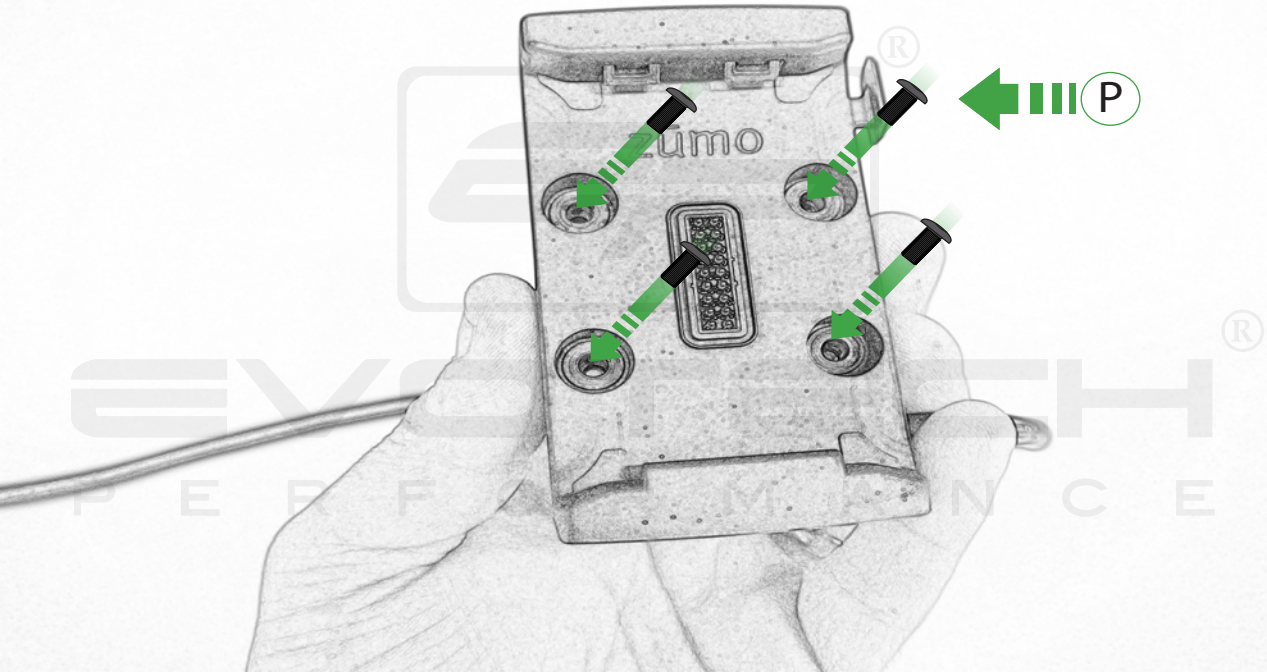



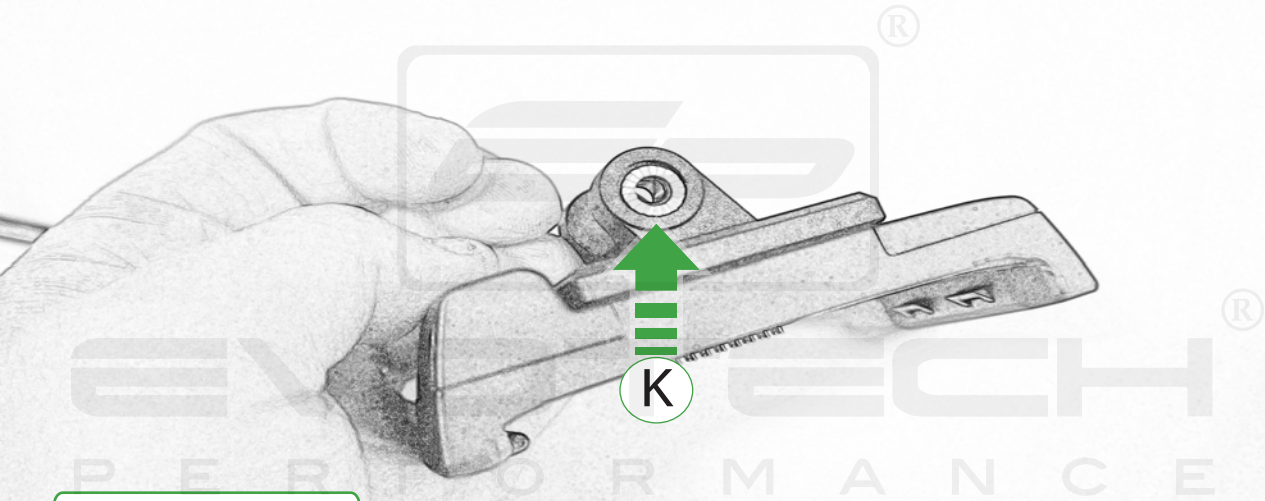

Repeat  
Both Sides



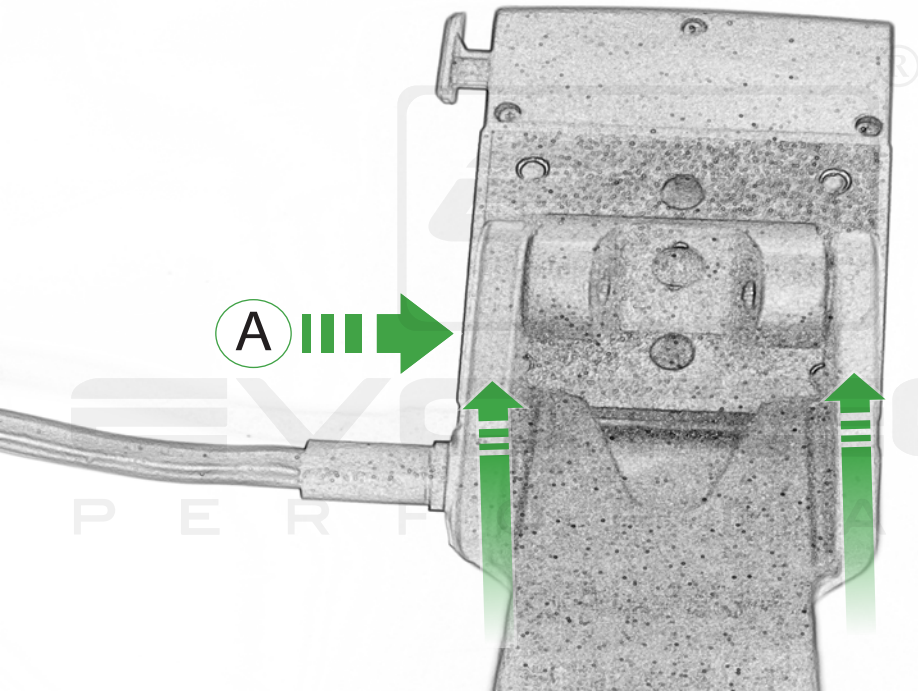

A



EVER PERFORMANCE

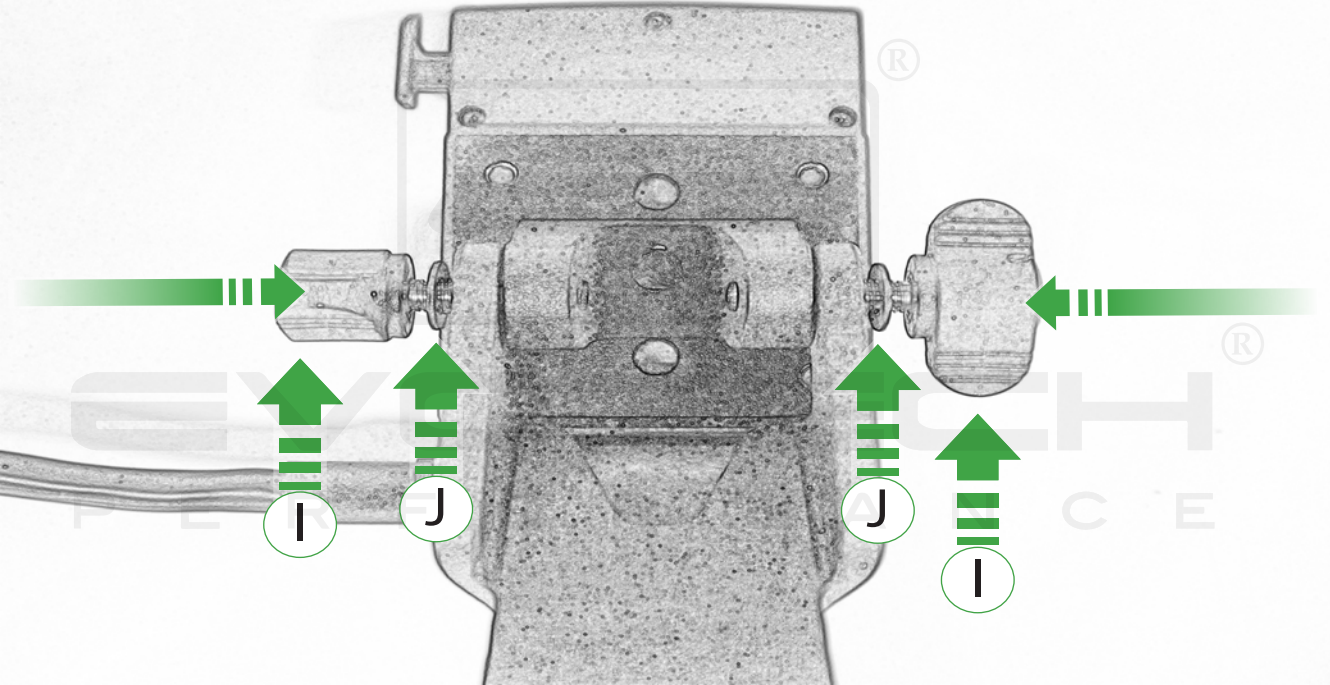

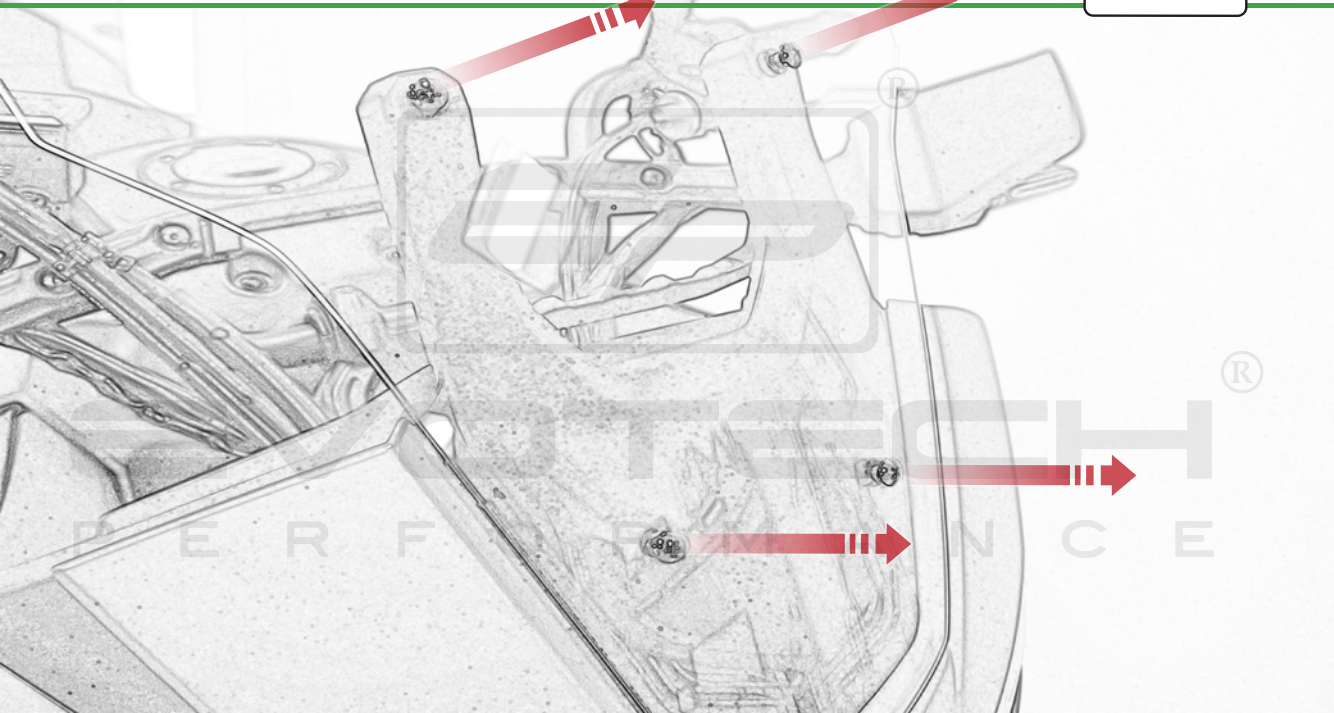

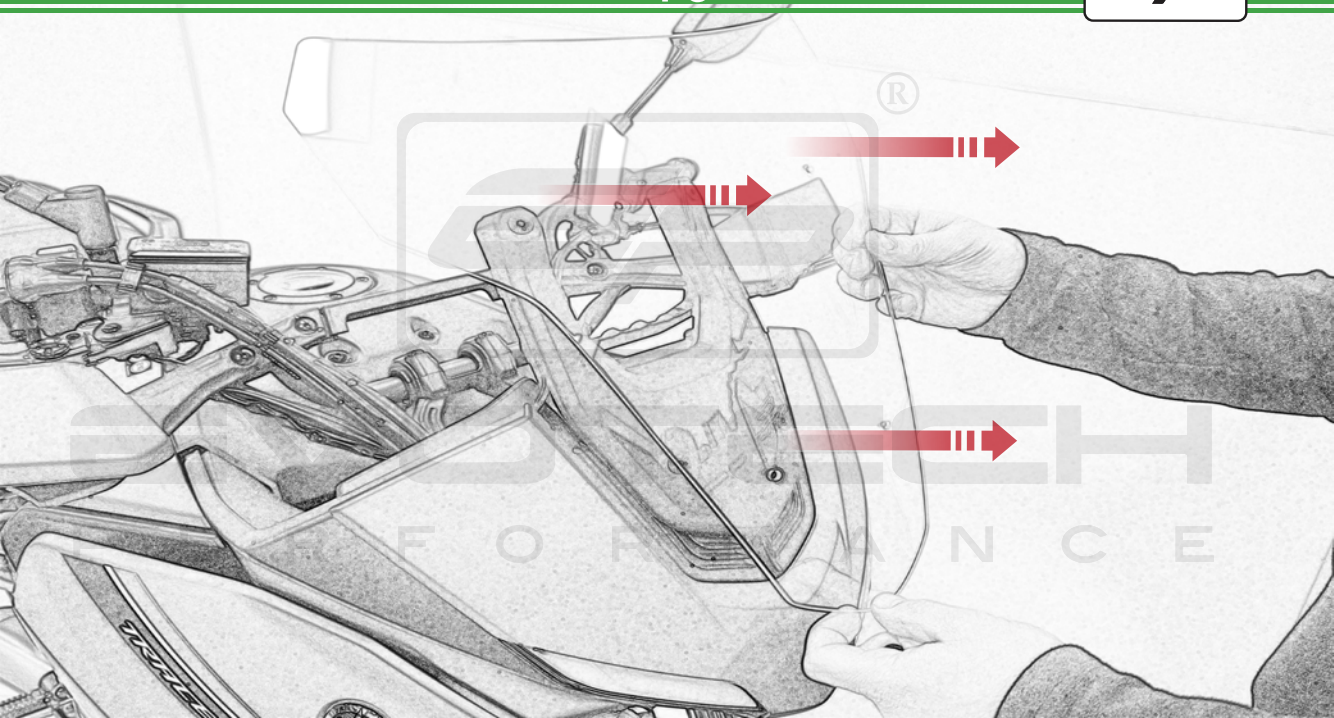

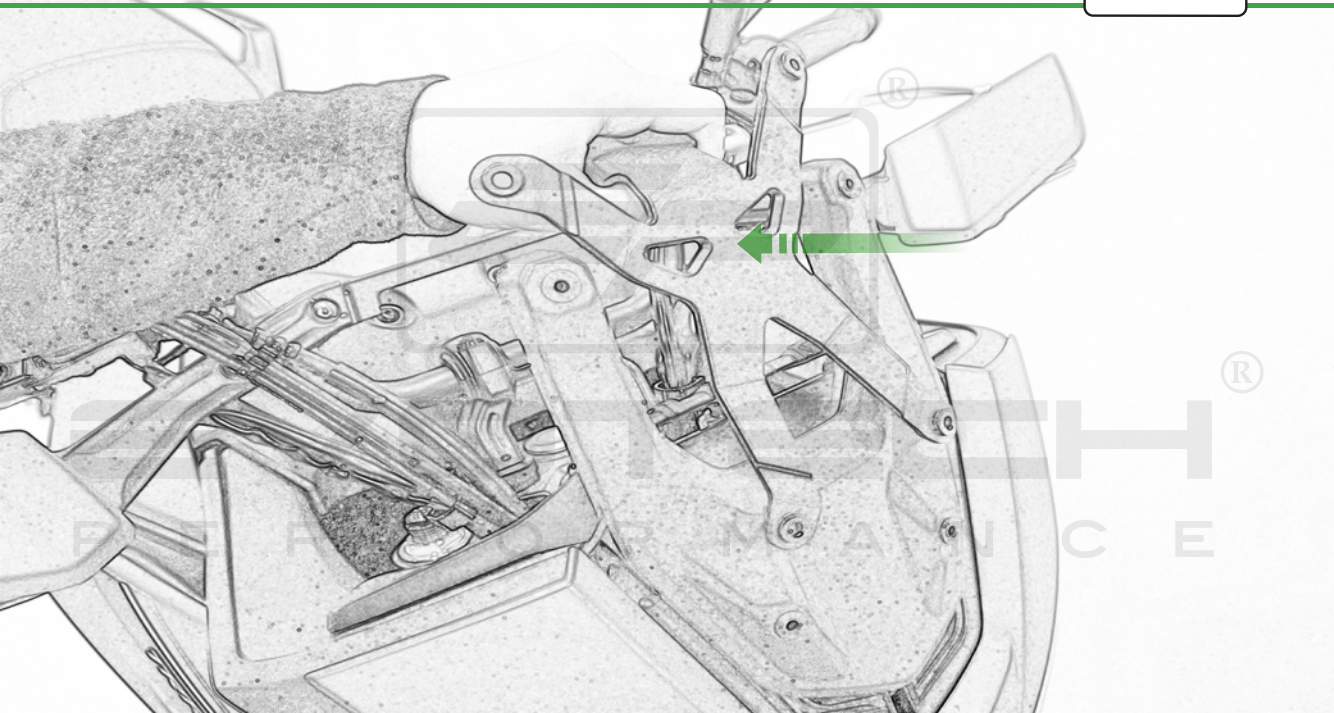

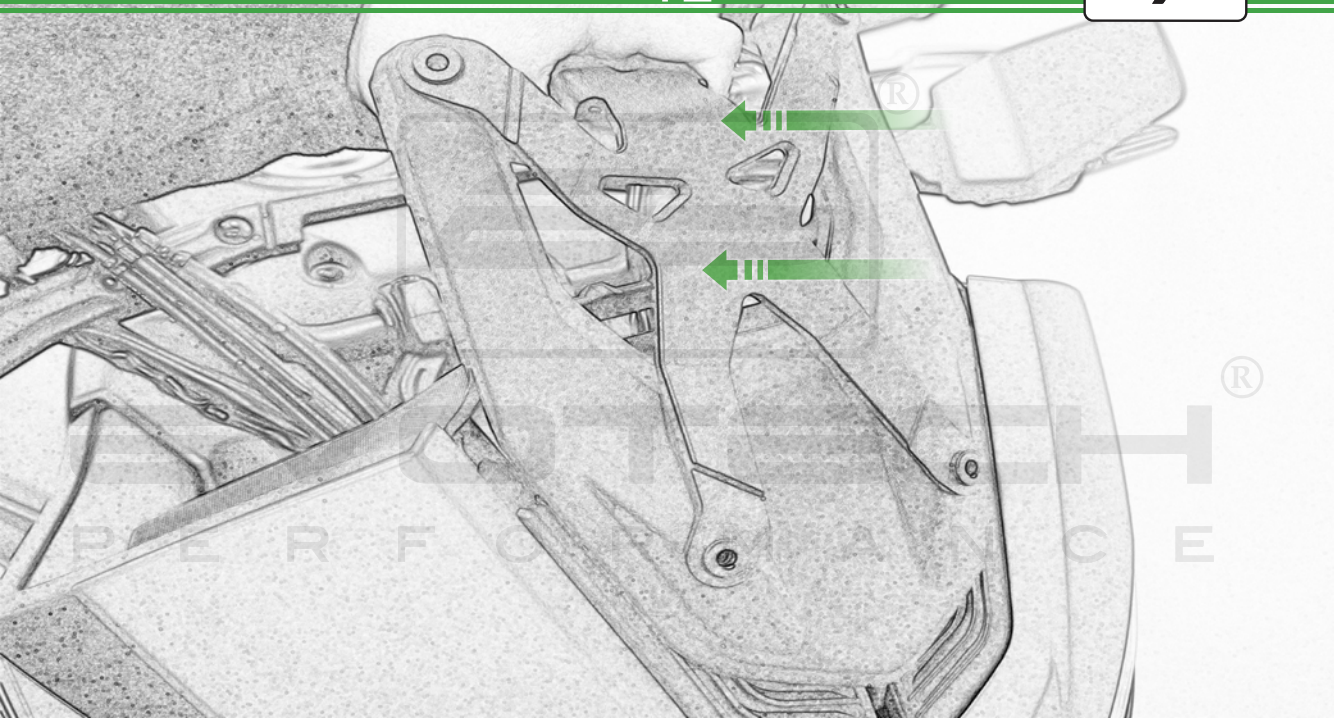

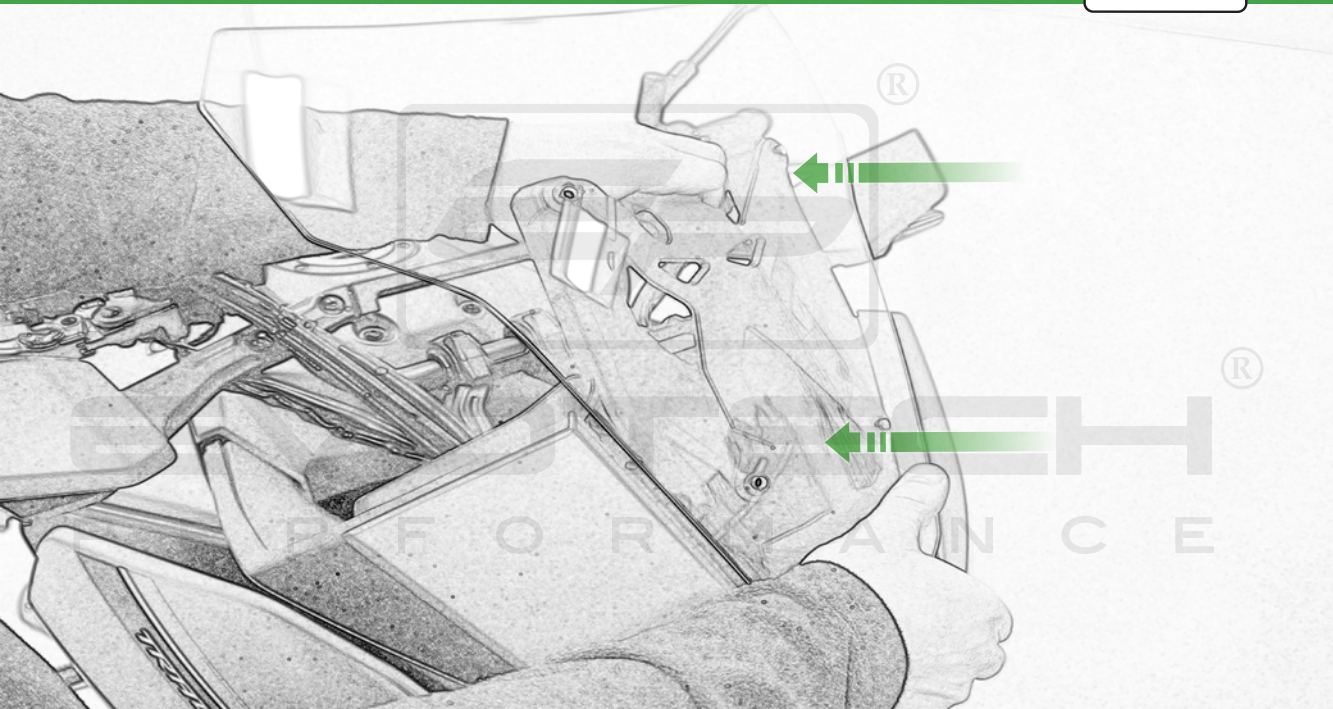

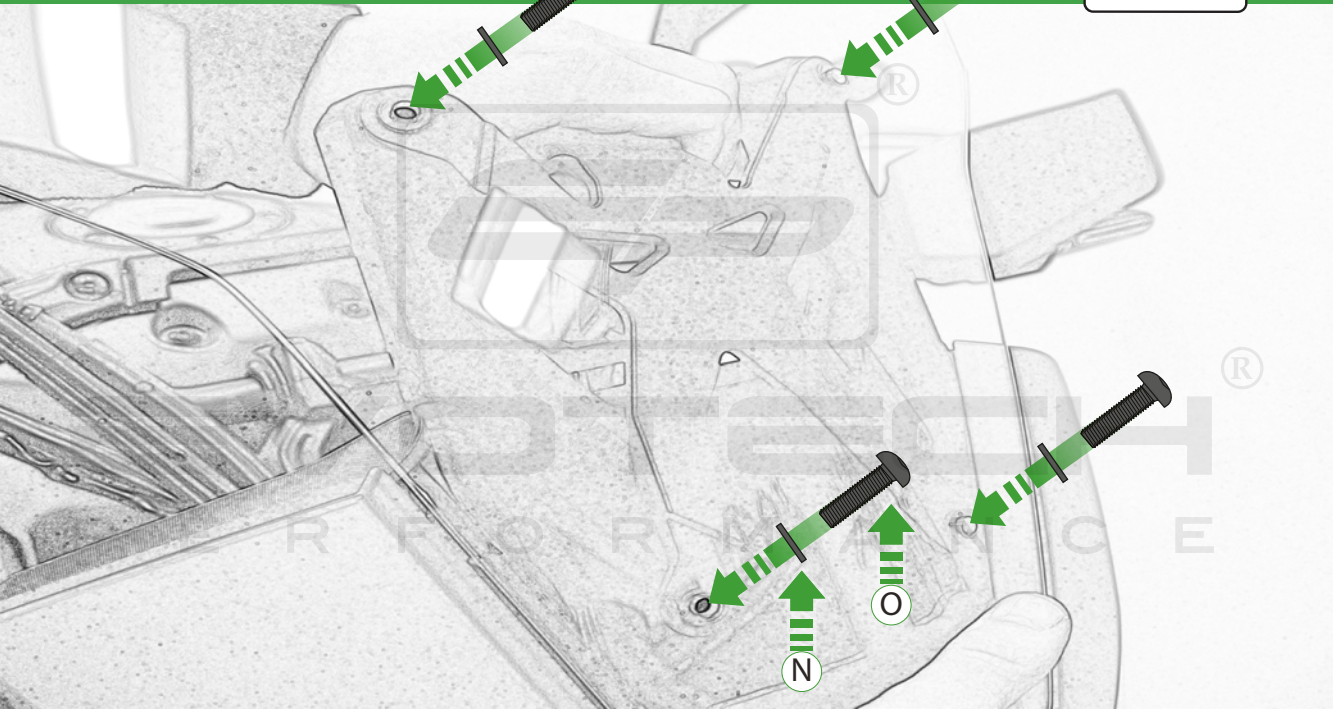



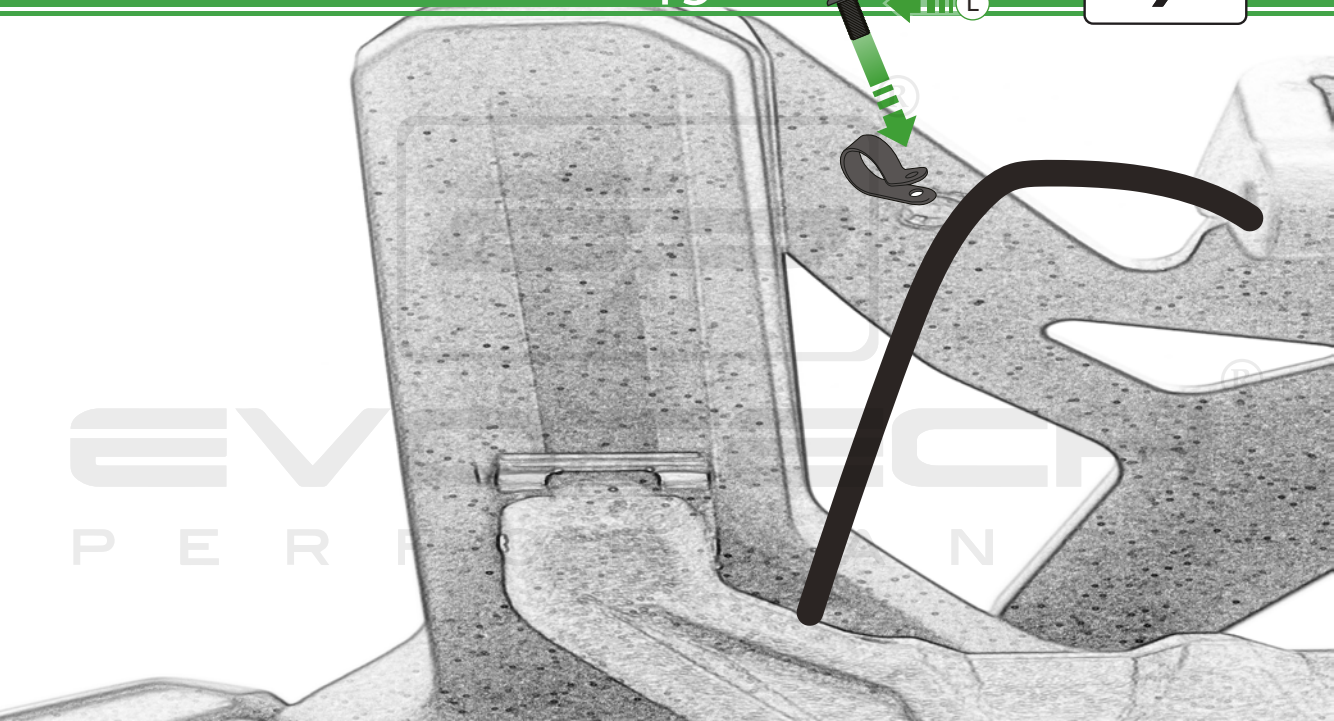

ELEVATED  
PERFORMANCE



## **ESSENTIAL CHECKS**

It is recommended that periodic inspections are made to ensure that all bolts are tightened to the specified torque settings.

Should the bike be involved in an accident a thorough inspection should be made and any components that have taken an impact, no matter how small, be replaced

P E R F O R M A N C E



**EVOTECH**®  
P E R F O R M A N C E

[www.evotech-performance.com](http://www.evotech-performance.com)