



EVOTECH®
P E R F O R M A N C E

www.evotech-performance.com

Kawasaki Ninja Z 1000SX
SP Connect Sat Nav Mount



For SP Connect mirco stem mount alu Part number #53122
follow instructions 1 - 13

For SP Connect anti vibration module Part number #53135
follow instructions 14 - 23



Kit Contents PRN014677-015098

- | | |
|-----------------------------------|------------------------------------|
| (A) 1 x M6 x 16 Countersunk Screw | (L) 2 x M5 Black Washer |
| (B) 1 x Pivot Plate | (M) 2 x M4 x 5mm Button Head Bolts |
| (C) 1 x SP Connect Plate | |
| (D) 1 x Spanner | |
| (E) 2 x M5 x 10mm Caphead Bolts | Sub Kit |
| (F) 2 x P-clips (No.1) | (N) 2 x M6 x 35mm CapHead Bolt |
| (G) 2 x P-clips (No.2) | (M) 2 x M5 Nylock Nut |
| (H) 2 x P-clips (No.3) | |
| (I) 2 x P-clips (No.4) | |
| (J) 2 x Lobe Screw | |
| (K) 2 x Locking Washer | |

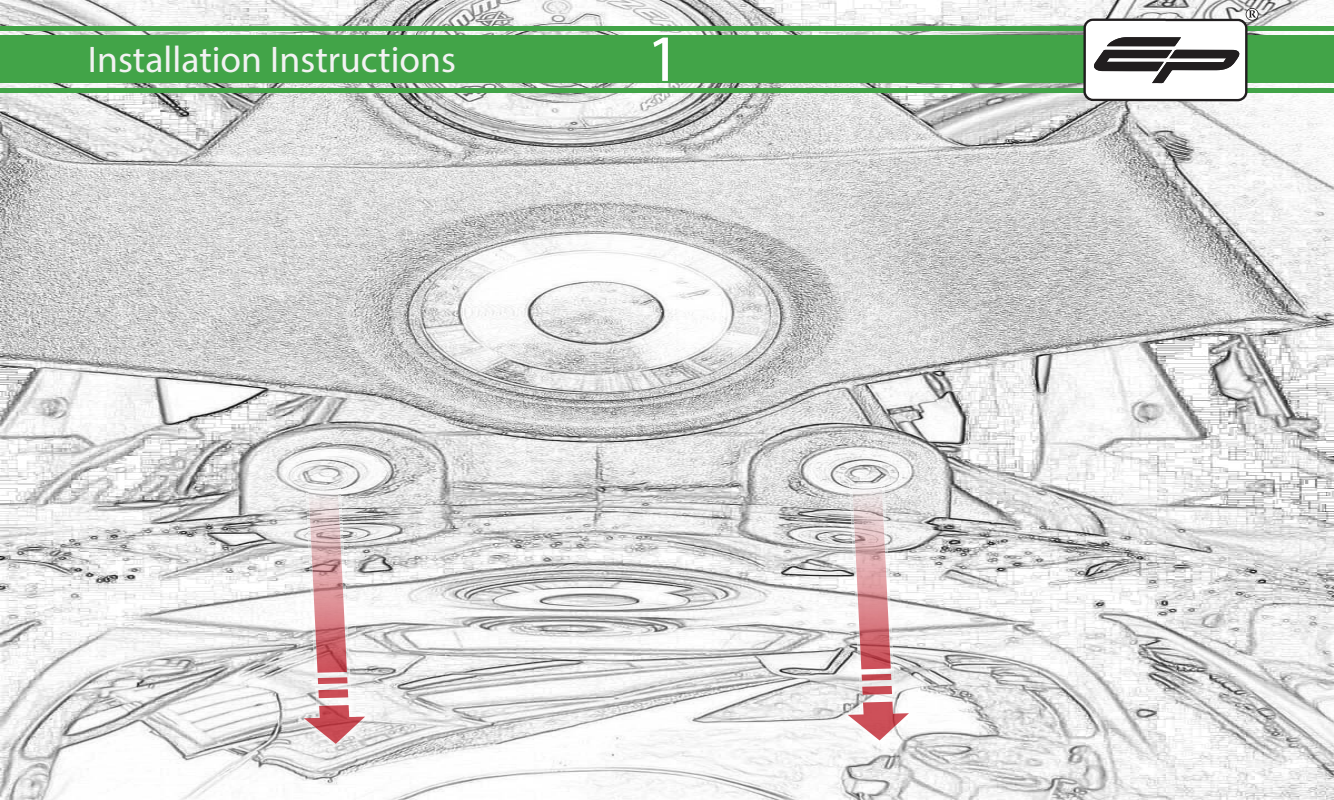

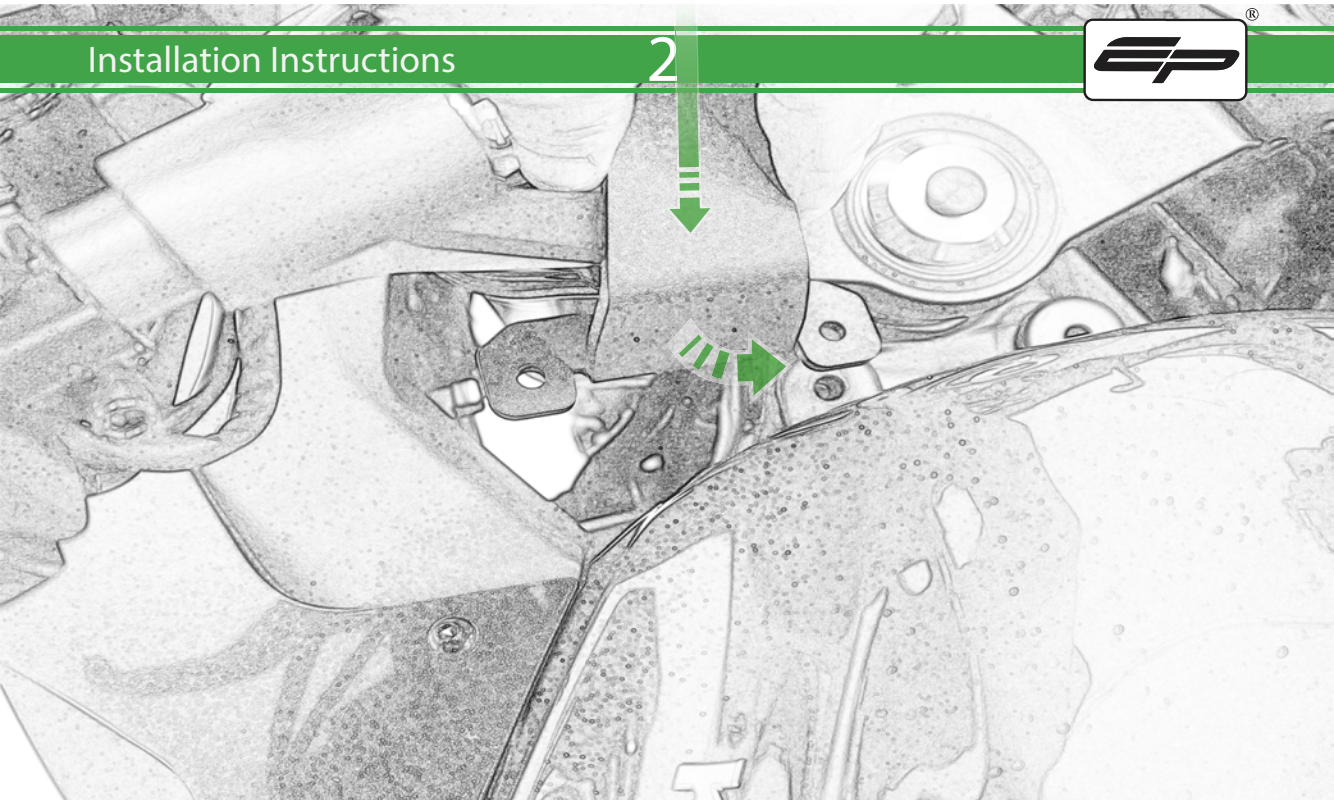



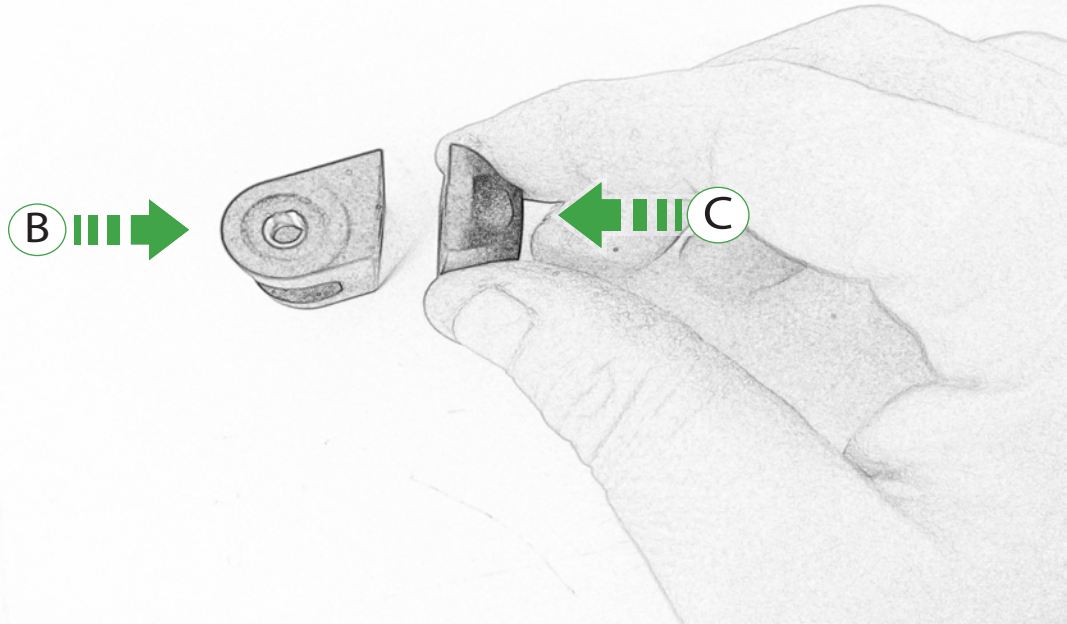

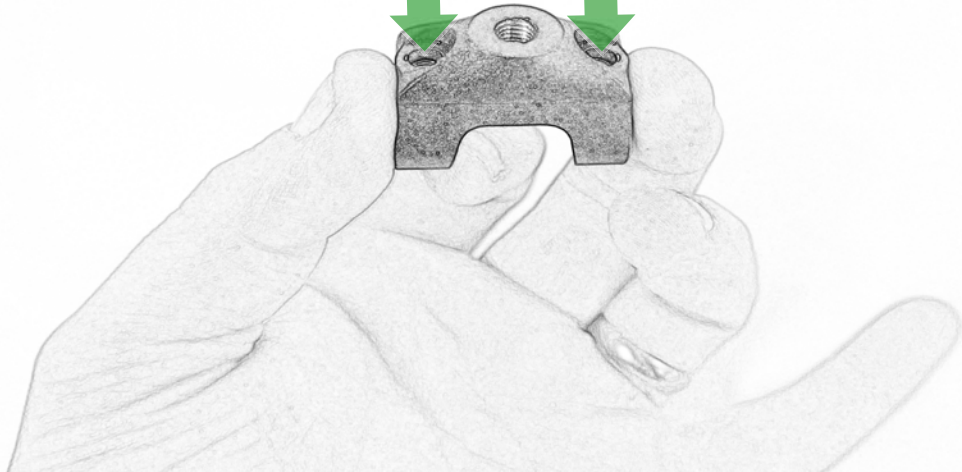
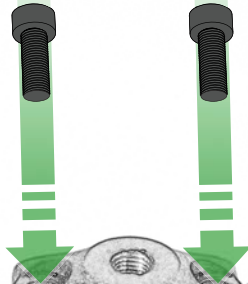

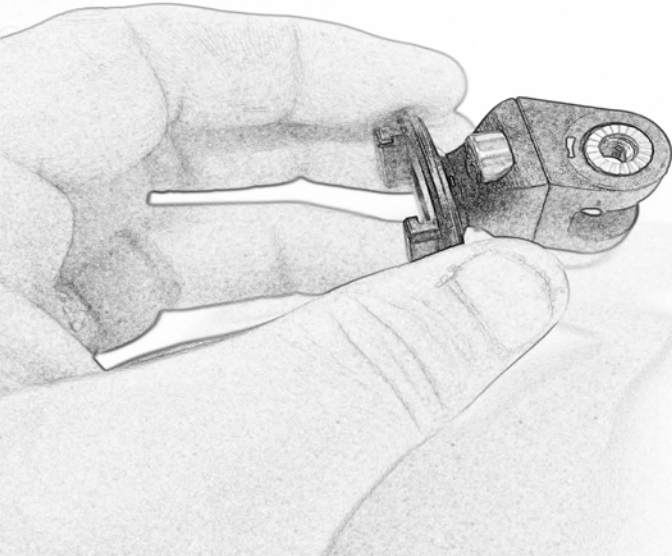

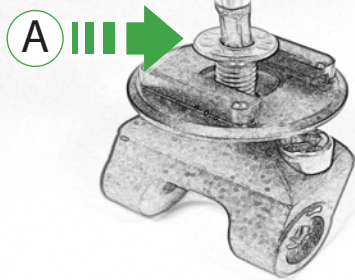

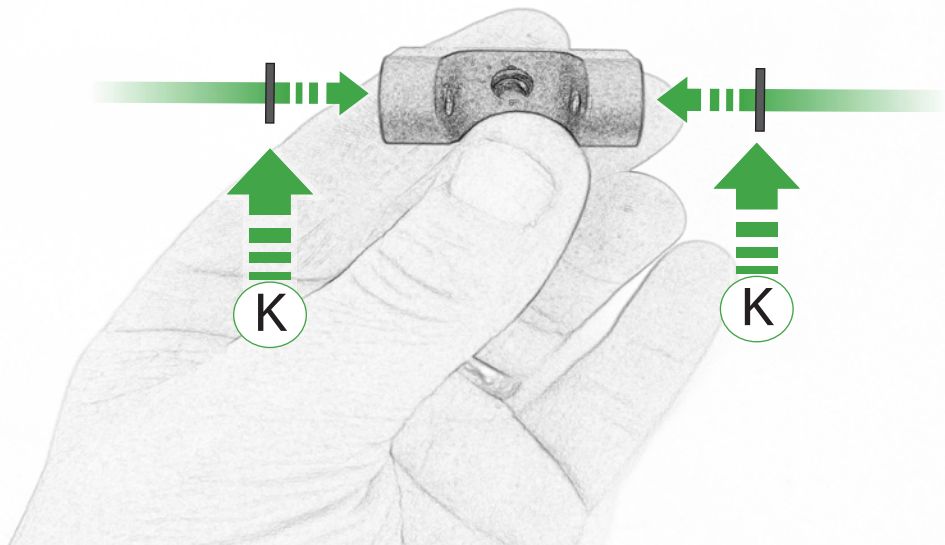

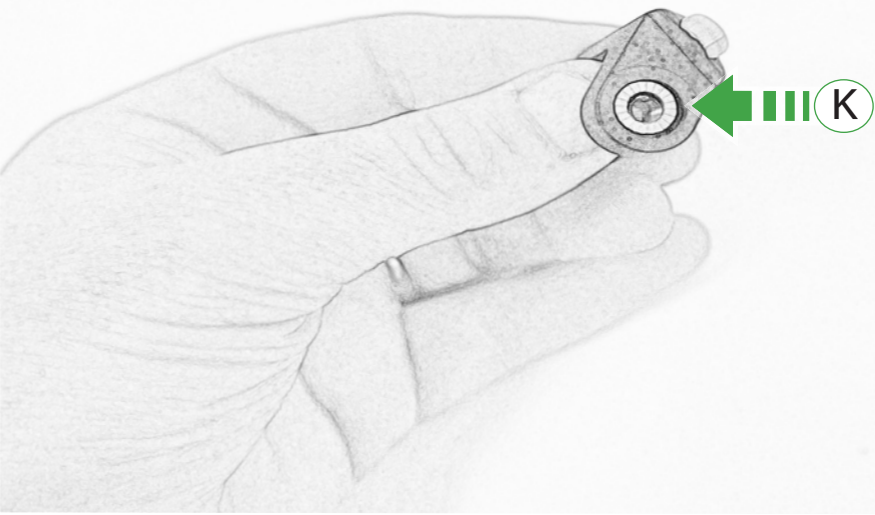

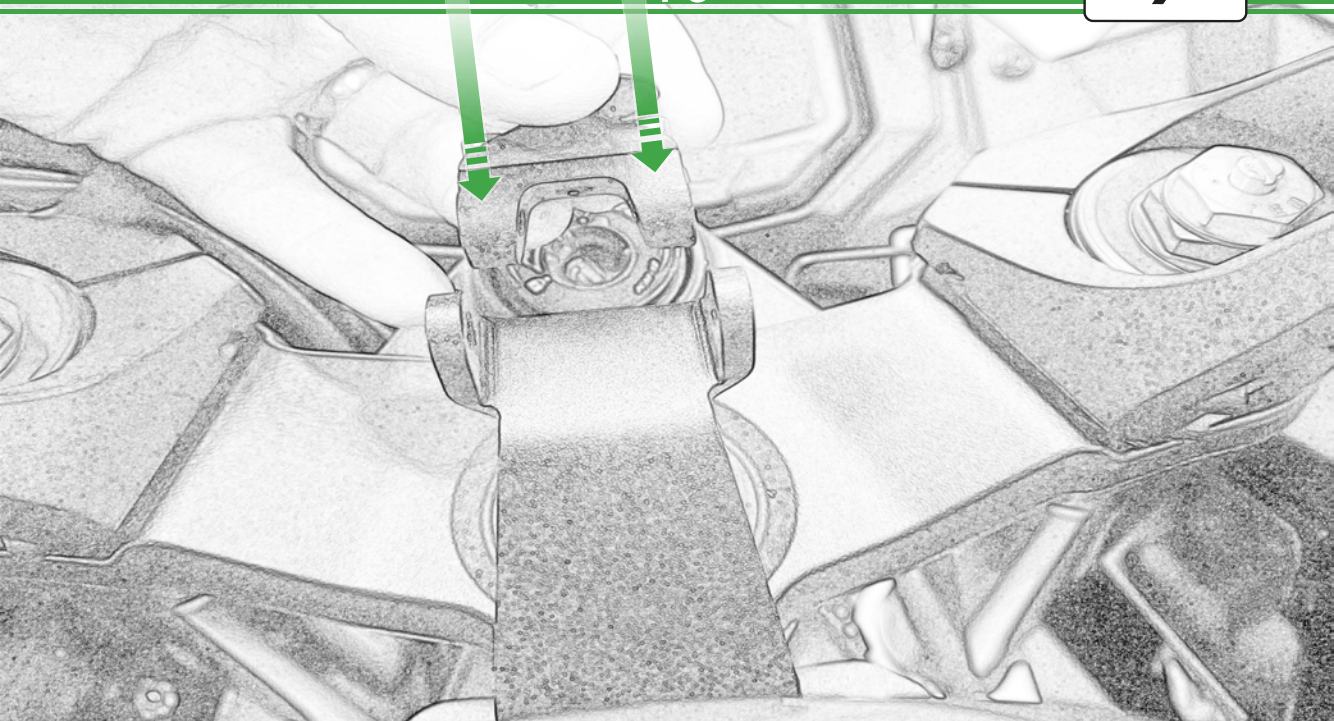

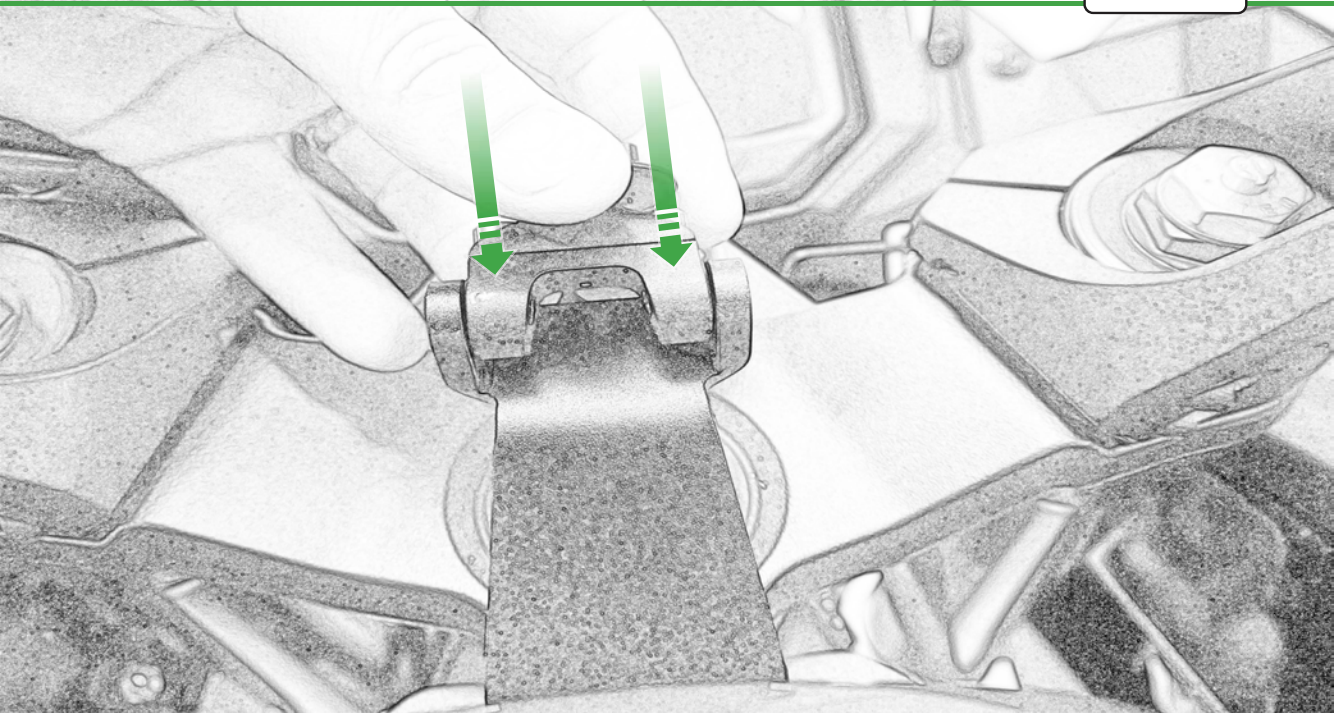

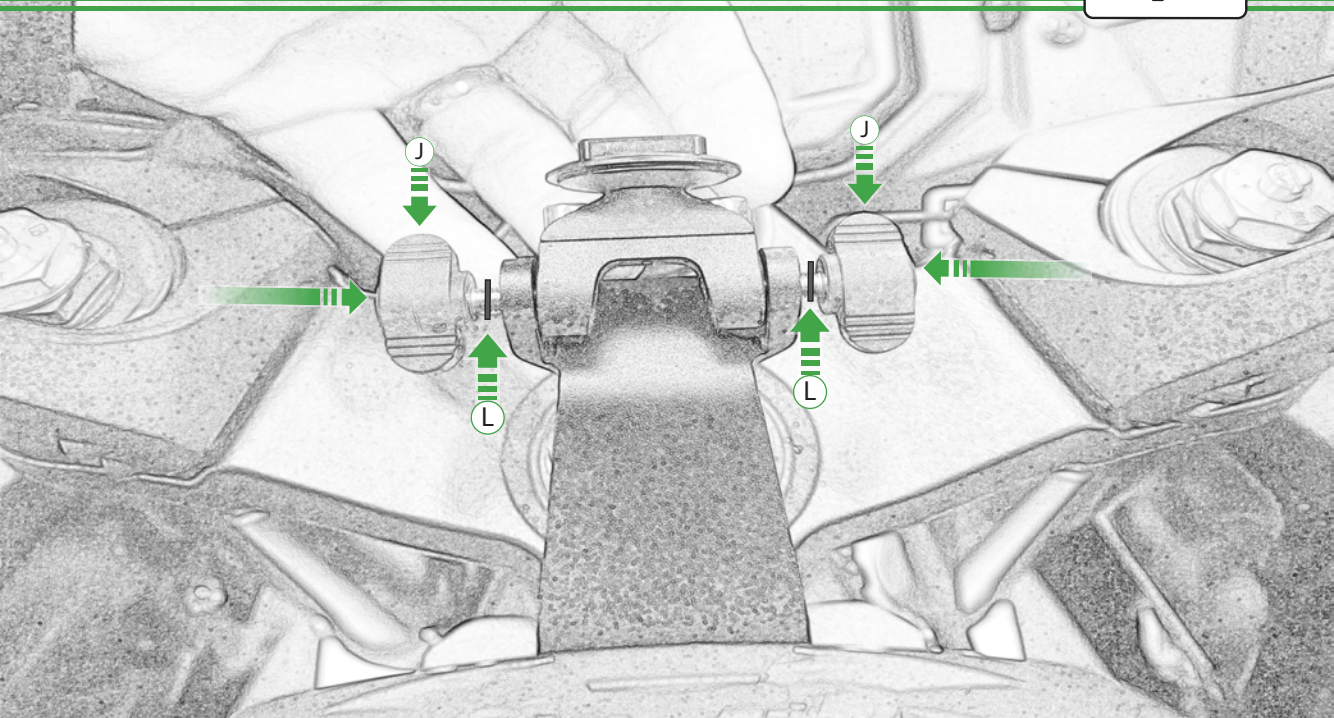

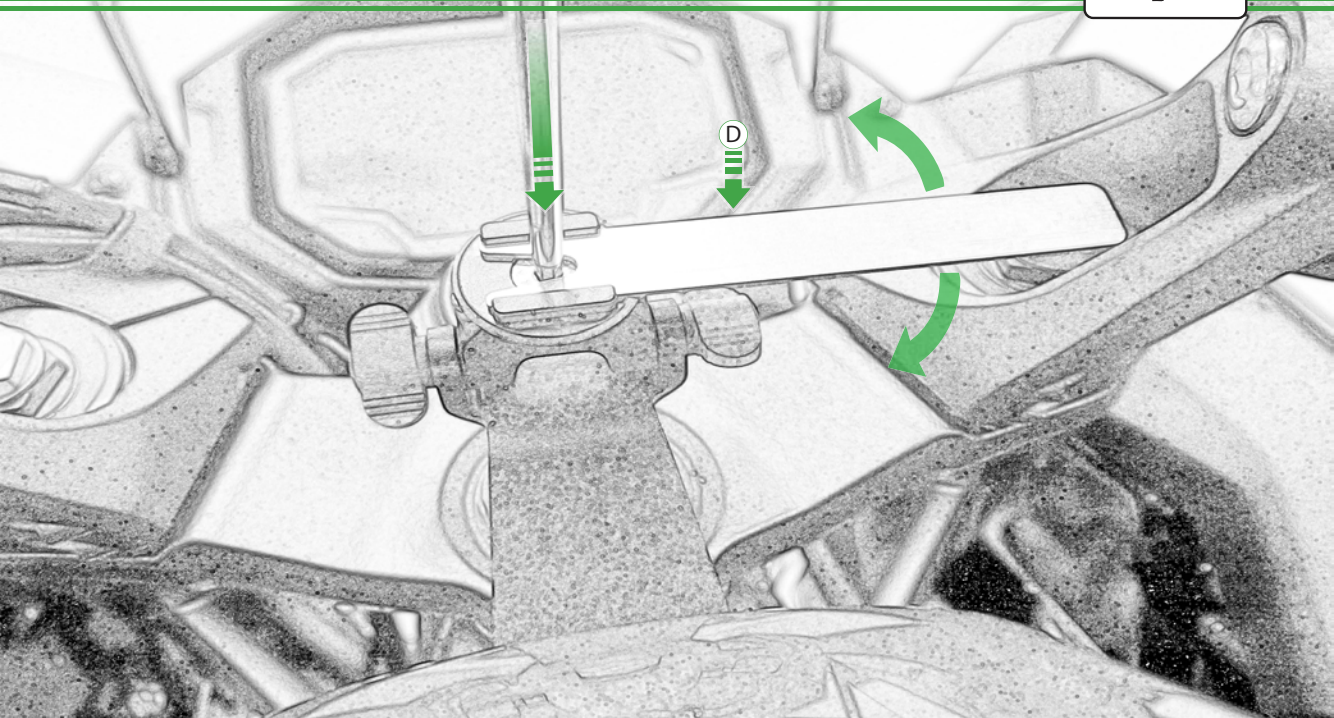



Kit Contents PRN014677-015098

- | | |
|-----------------------------------|------------------------------------|
| (A) 1 x M6 x 16 Countersunk Screw | (L) 2 x M5 Black Washer |
| (B) 1 x Pivot Plate | (M) 2 x M4 x 5mm Button Head Bolts |
| (C) 1 x SP Connect Plate | |
| (D) 1 x Spanner | |
| (E) 2 x M5 x 10mm Caphead Bolts | Sub Kit |
| (F) 2 x P-clips (No.1) | (N) 2 x M6 x 35mm CapHead Bolt |
| (G) 2 x P-clips (No.2) | (M) 2 x M5 Nylock Nut |
| (H) 2 x P-clips (No.3) | |
| (I) 2 x P-clips (No.4) | |
| (J) 2 x Lobe Screw | |
| (K) 2 x Locking Washer | |

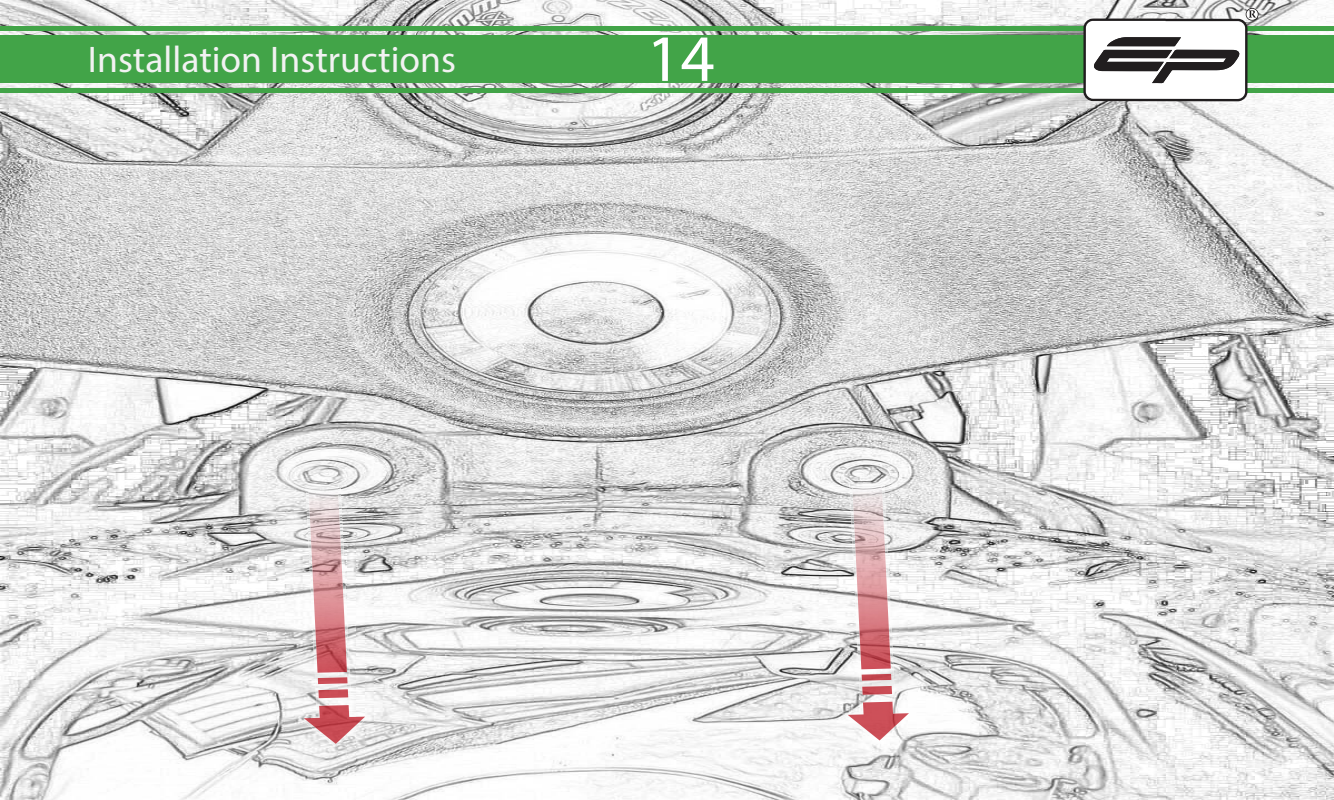

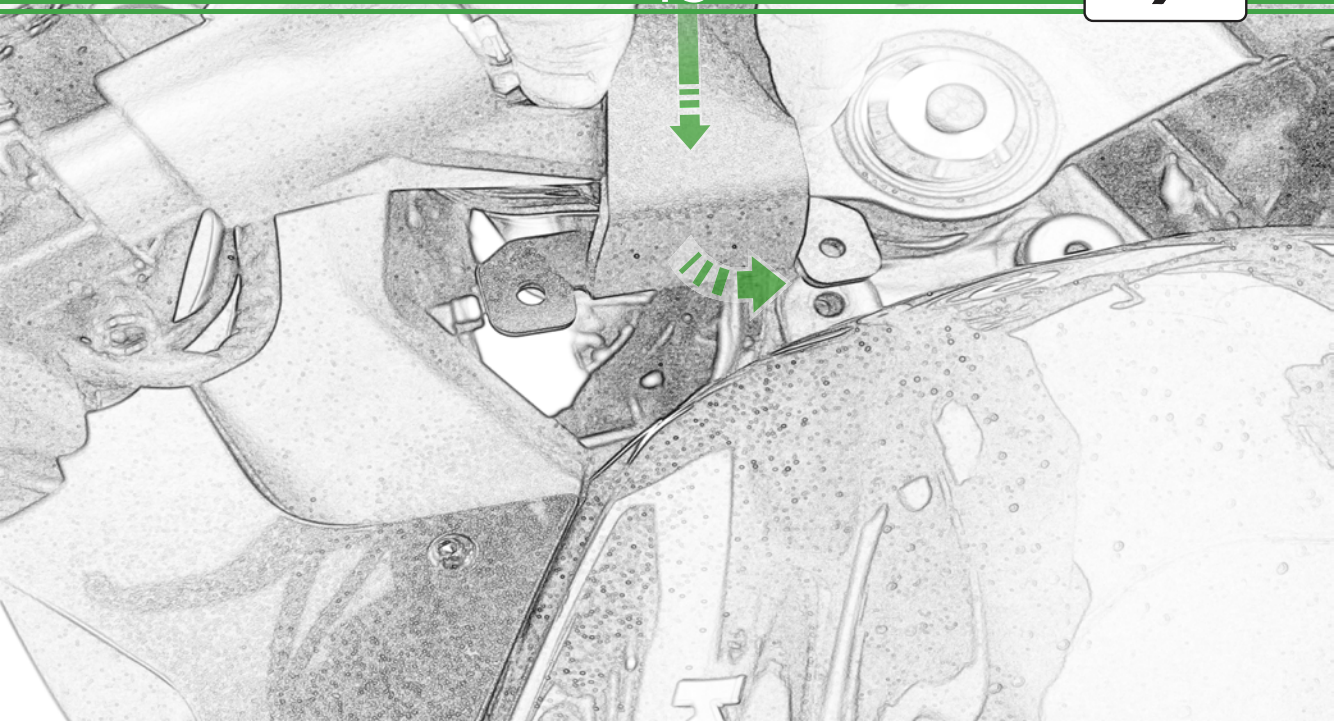



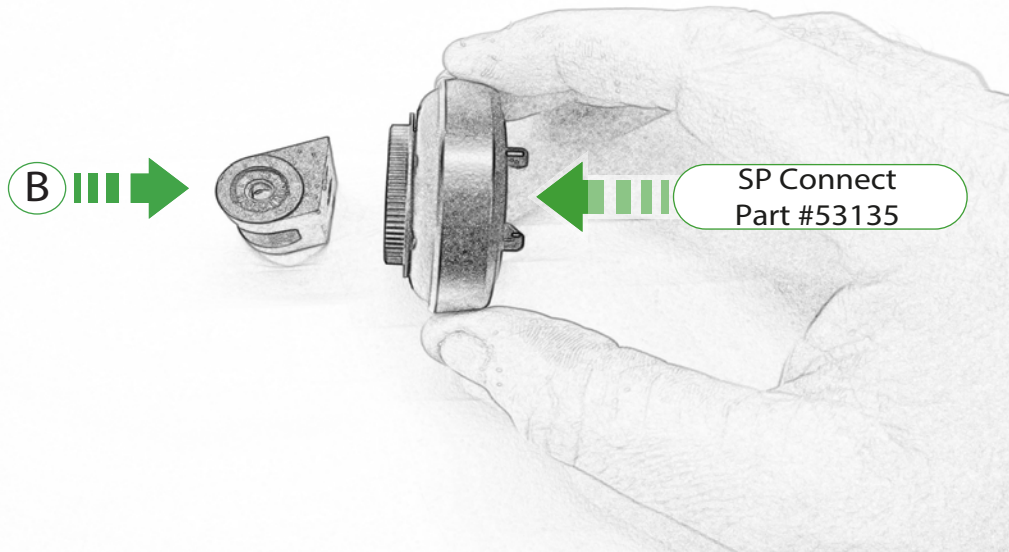

B

SP Connect
Part #53135



Supplied with
#53135

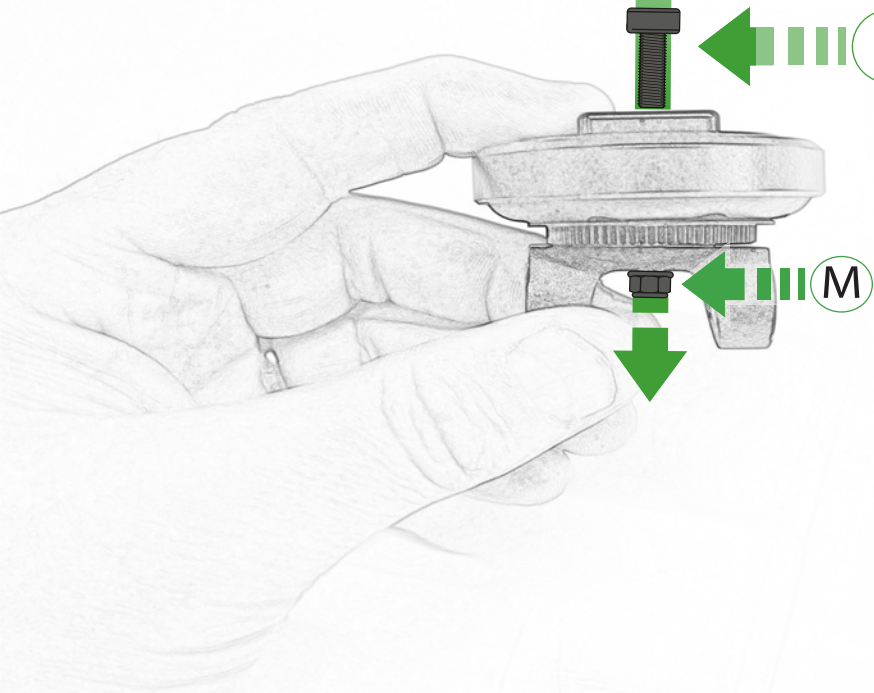

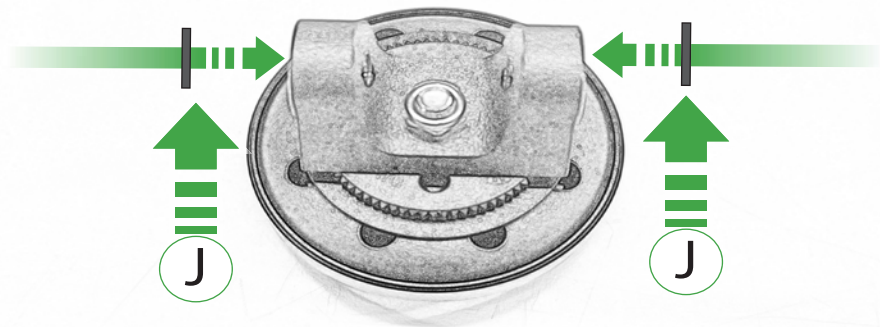

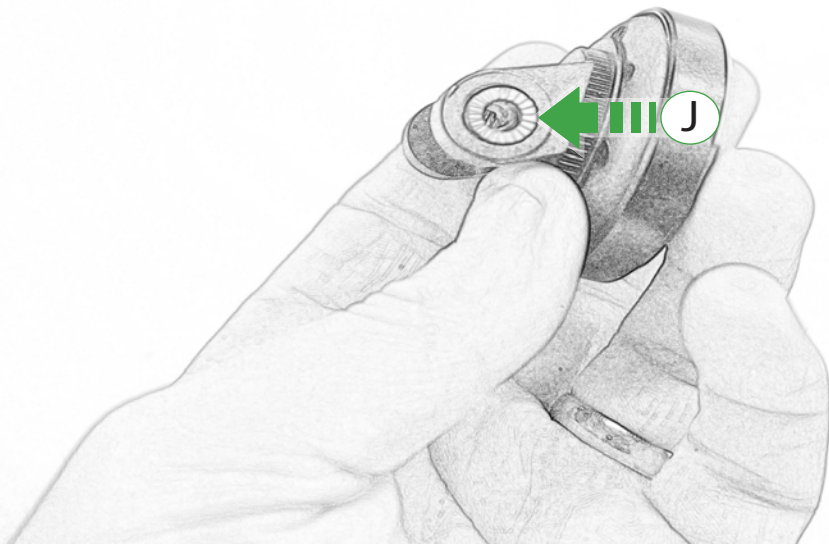

Repeat
Both Sides

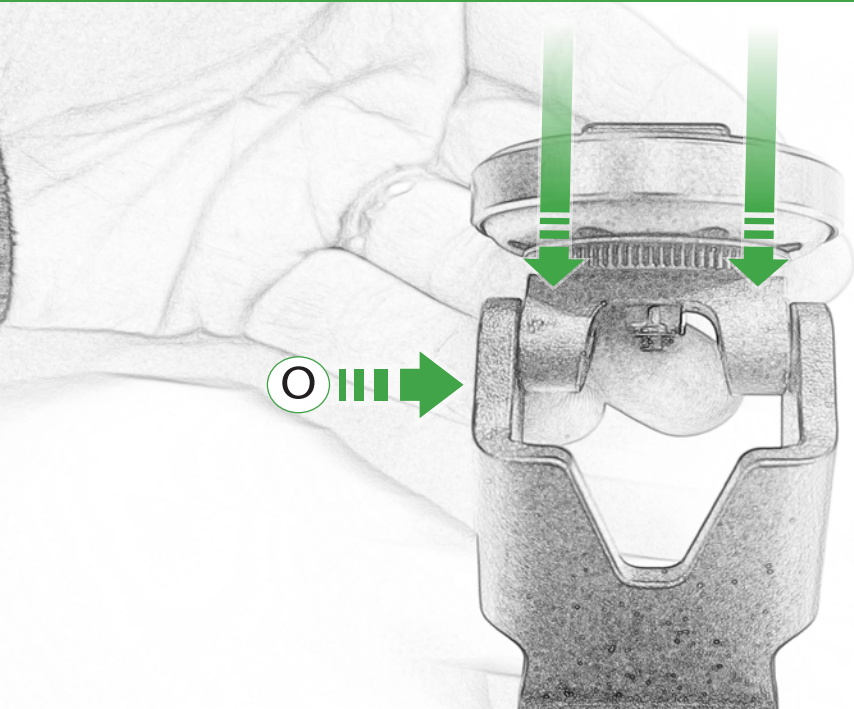

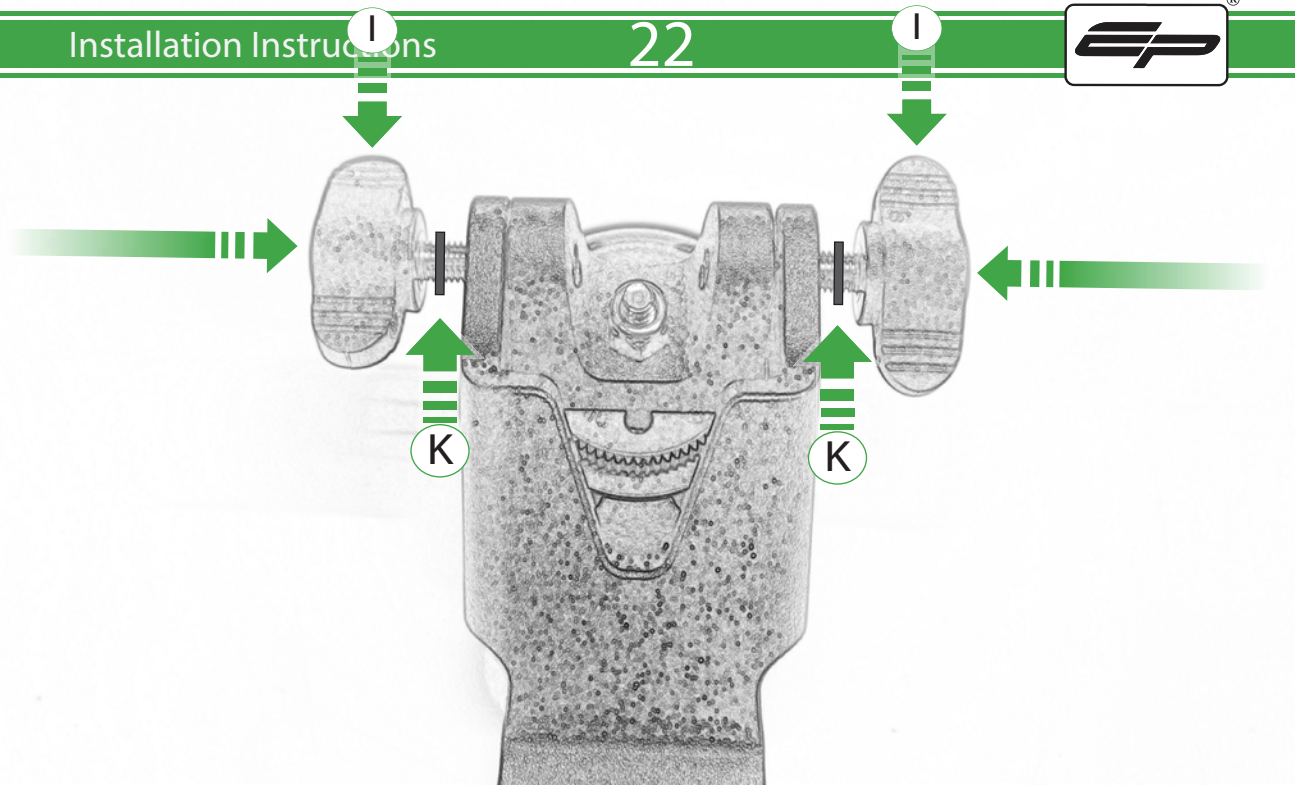

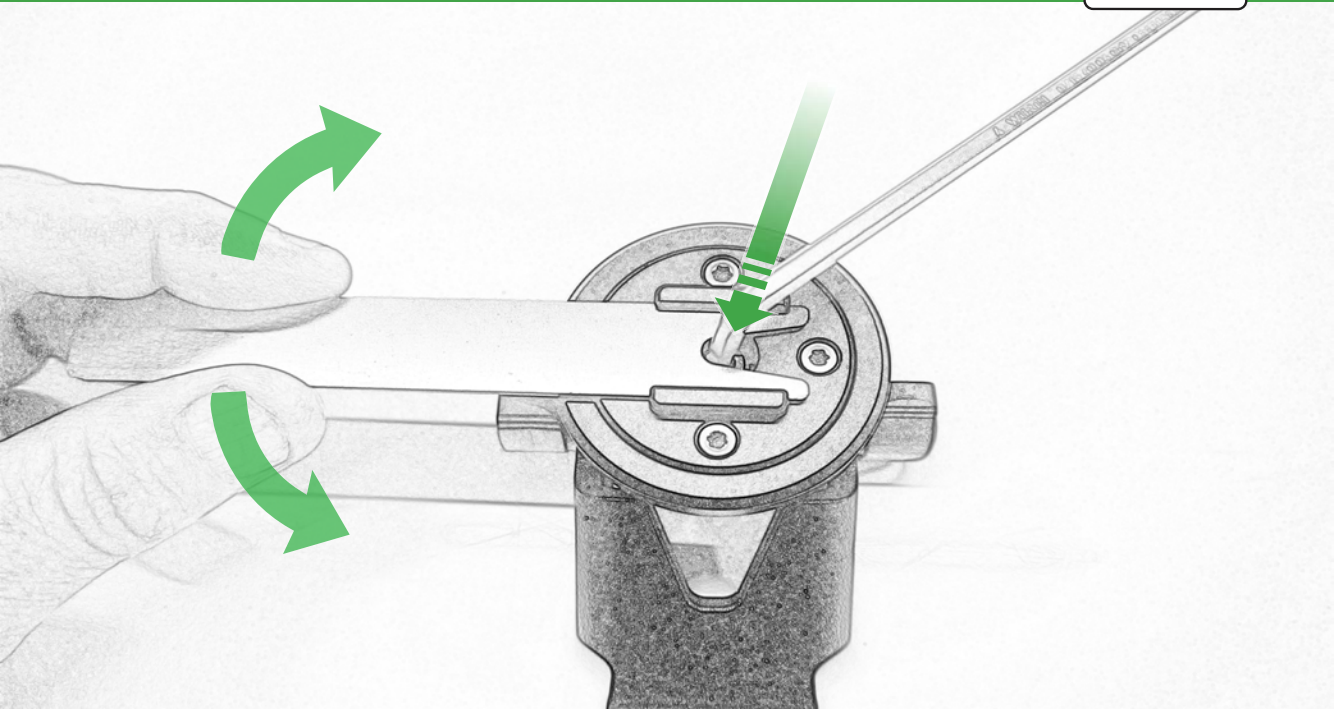



ESSENTIAL CHECKS

It is recommended that periodic inspections are made to ensure that all bolts are tightened to the specified torque settings.

Should the bike be involved in an accident a thorough inspection should be made and any components that have taken an impact, no matter how small, be replaced



EVOTECH®
P E R F O R M A N C E

www.evotech-performance.com