

**EVOTECH**®  
P E R F O R M A N C E

[www.evotech-performance.com](http://www.evotech-performance.com)

Suzuki V-Strom 650 SP Connect  
Sat Nav Mount



For SP Connect mirco stem mount alu Part number #53122  
follow instructions 1 - 14

For SP Connect anti vibration module Part number #53135  
follow instructions 15 - 28



## Kit Contents PRN014677-015151

- (A) 1 x M6 x 16 Countersunk Screw
- (B) 1 x Pivot Plate
- (C) 1 x SP Connect Plate
- (D) 1 x Spanner
- (E) 1 x M5 Nut
- (F) 2 x P-clips (No.1)
- (G) 2 x P-clips (No.2)
- (H) 2 x P-clips (No.3)
- (I) 2 x P-clips (No.4)
- (J) 2 x Lobe Screw
- (K) 2 x Locking Washer
- (L) 2 x M5 Black Washer
- (M) 2 x M4 x 5mm Button Head Bolts
- (O) 2 x M5 x 10mm Caphead Bolts

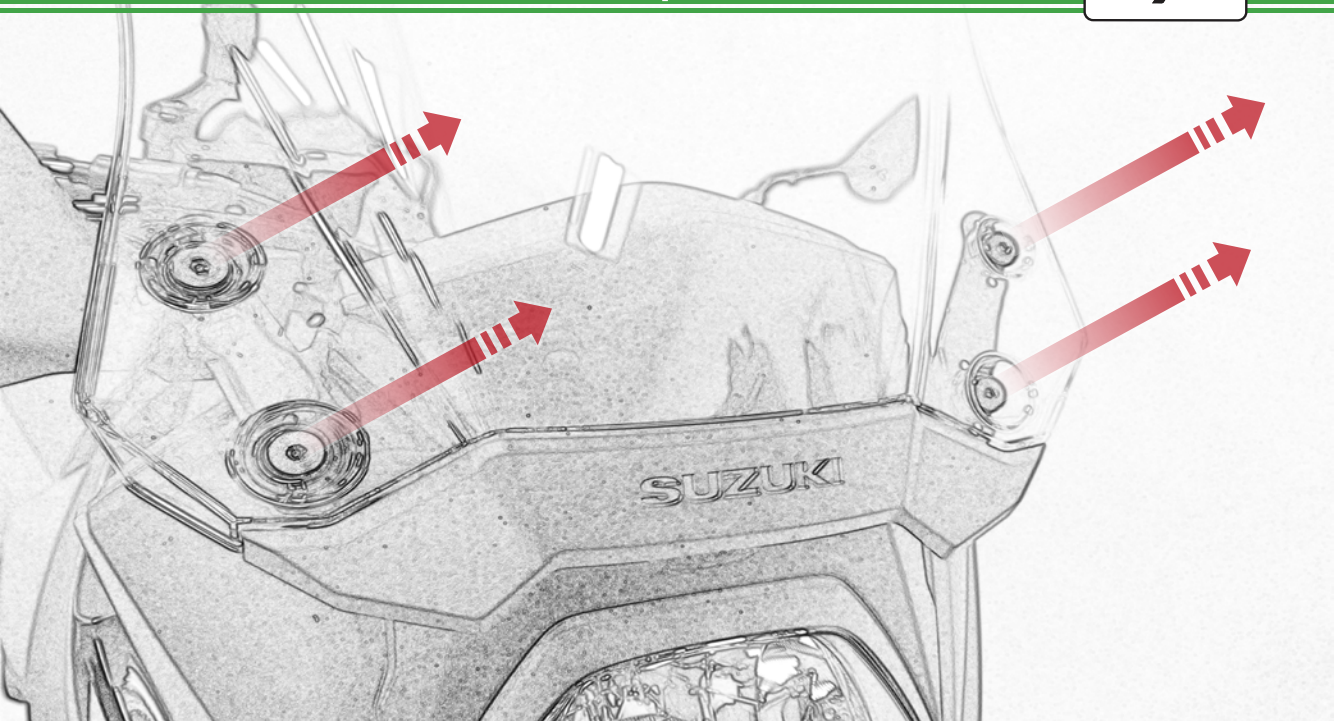

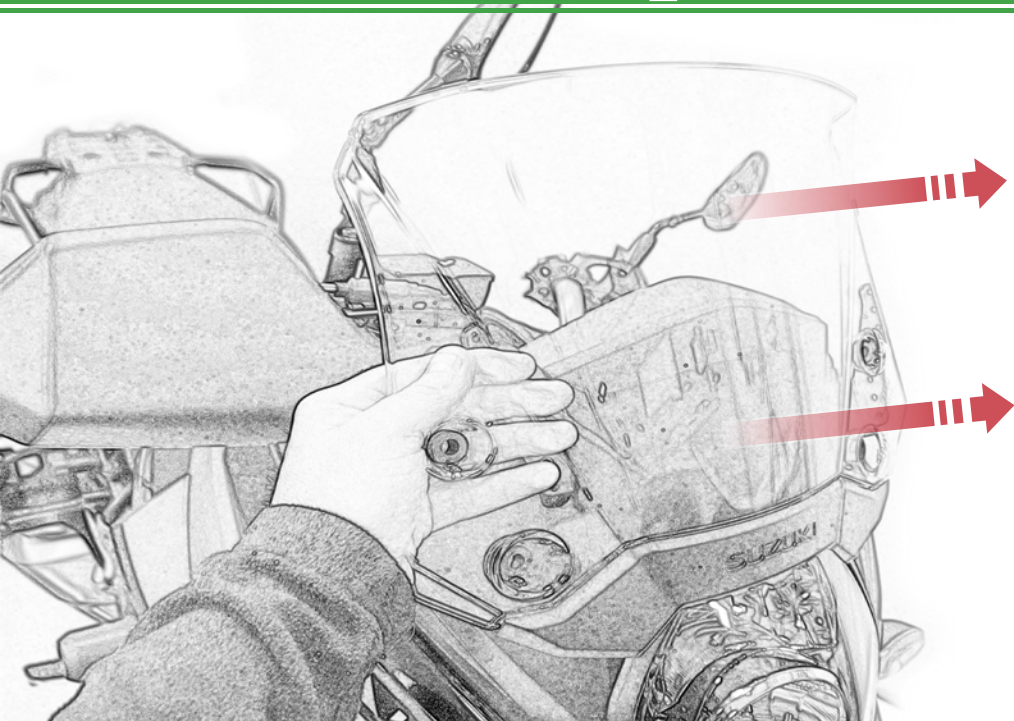

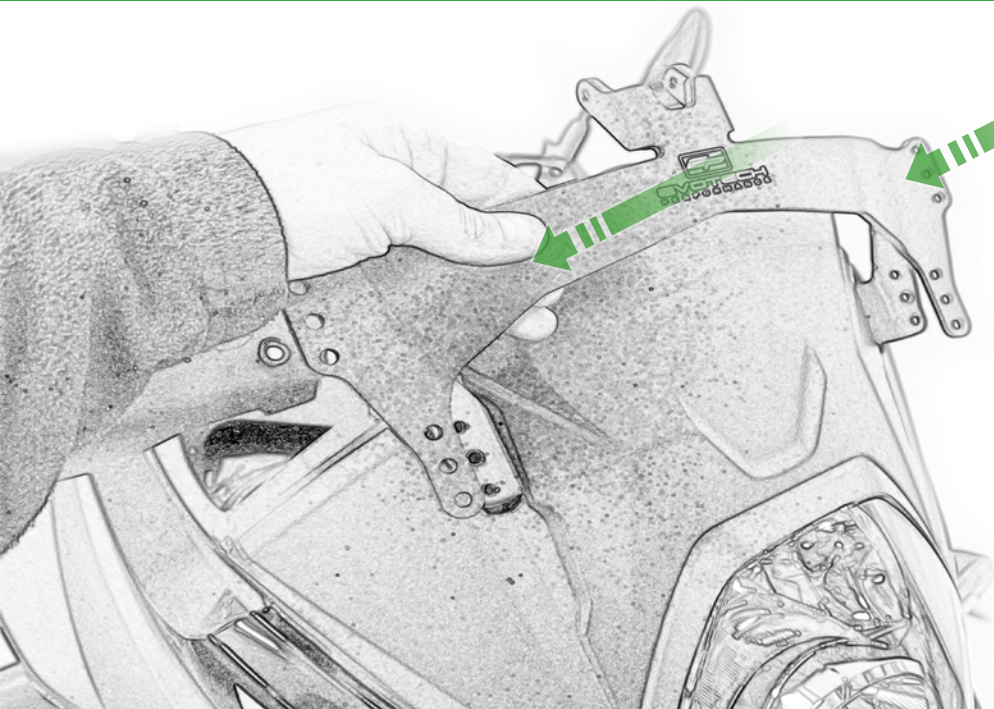

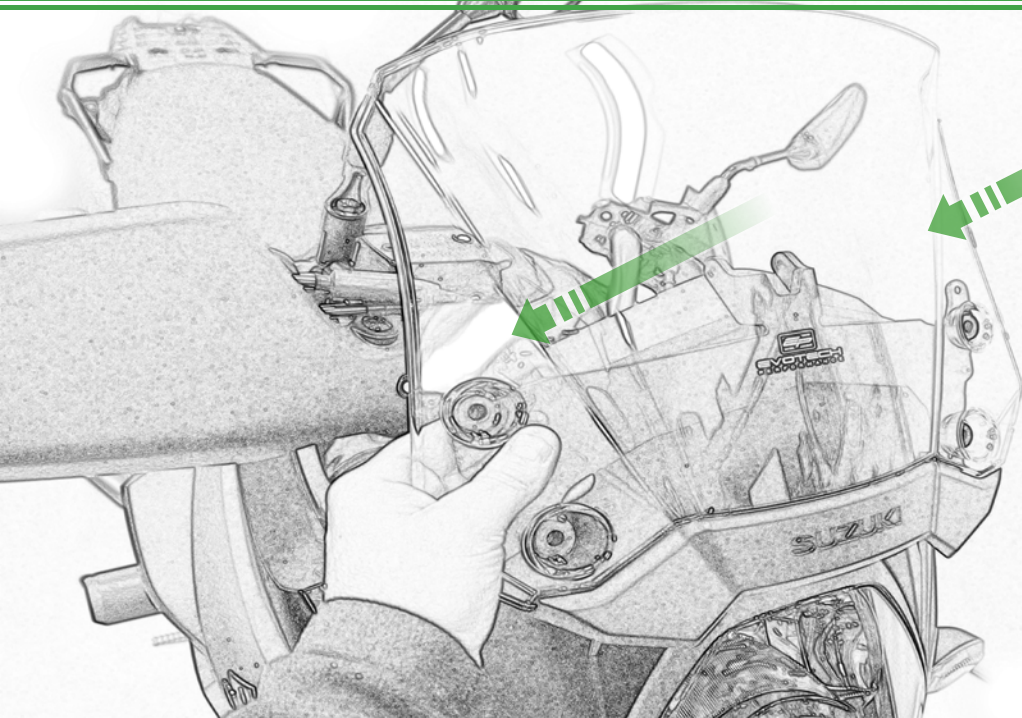



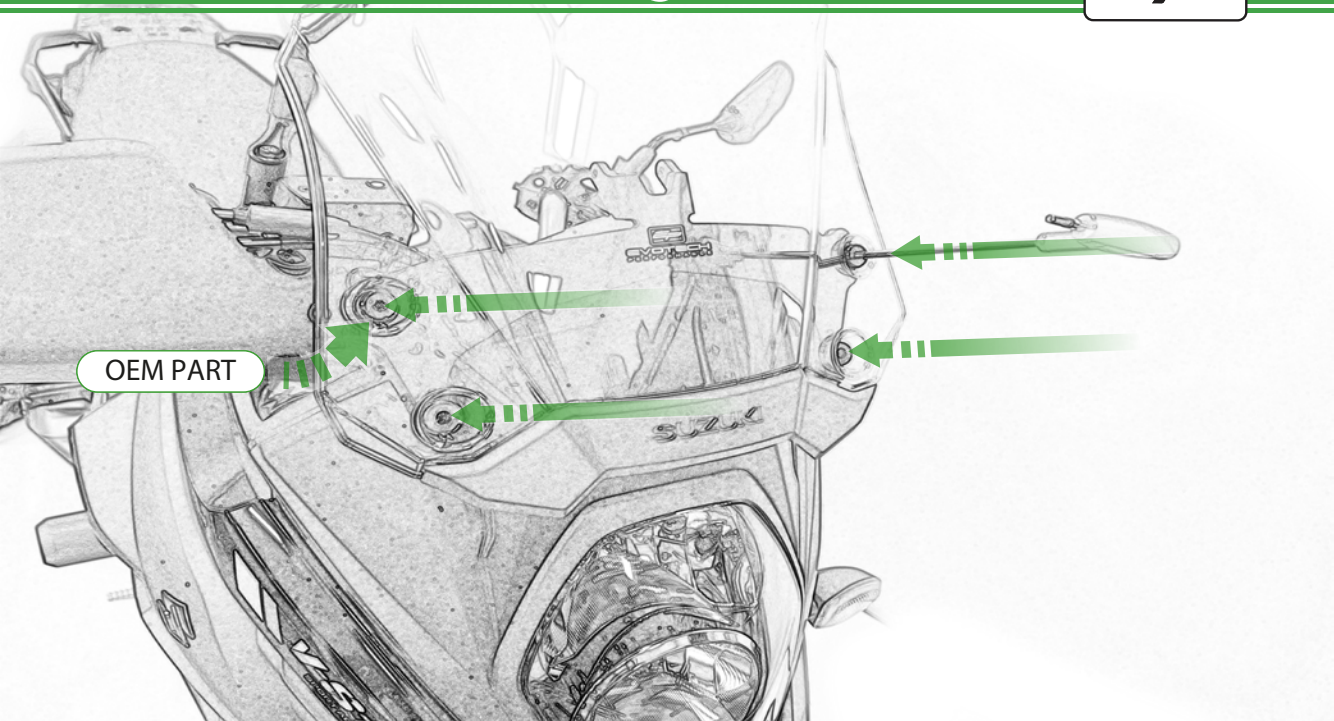

OEM PART



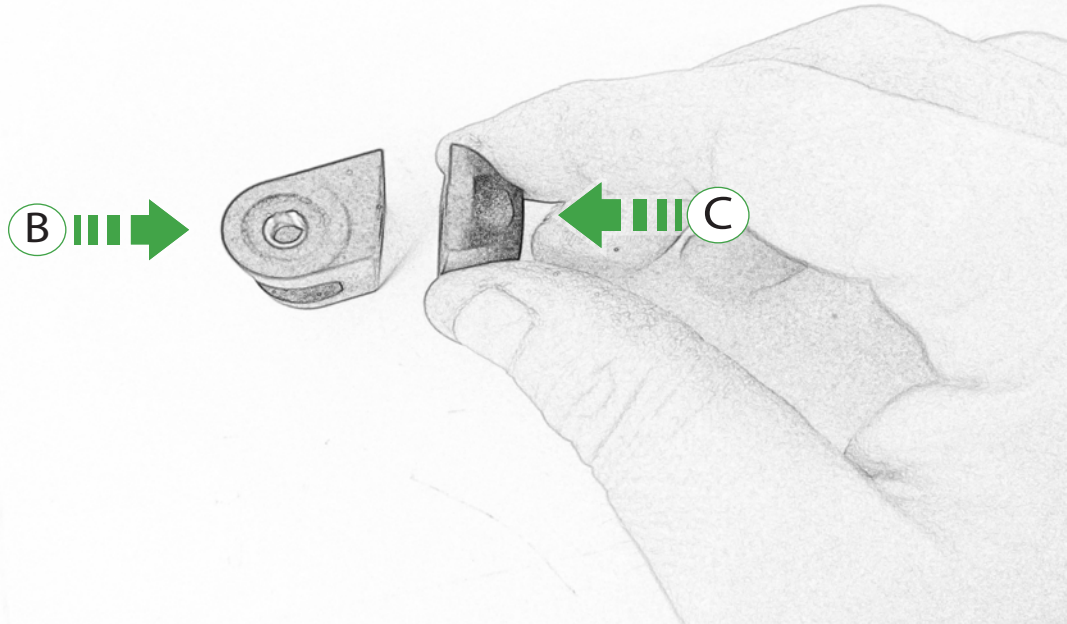

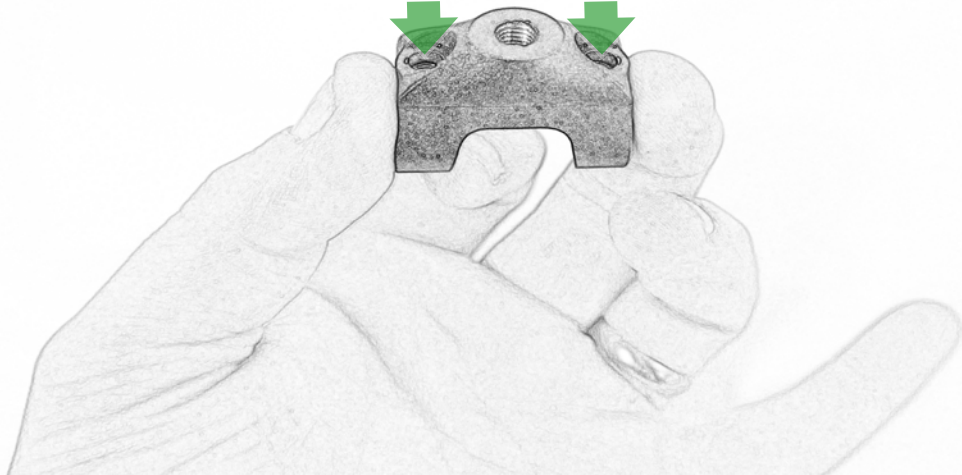
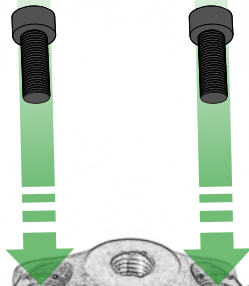

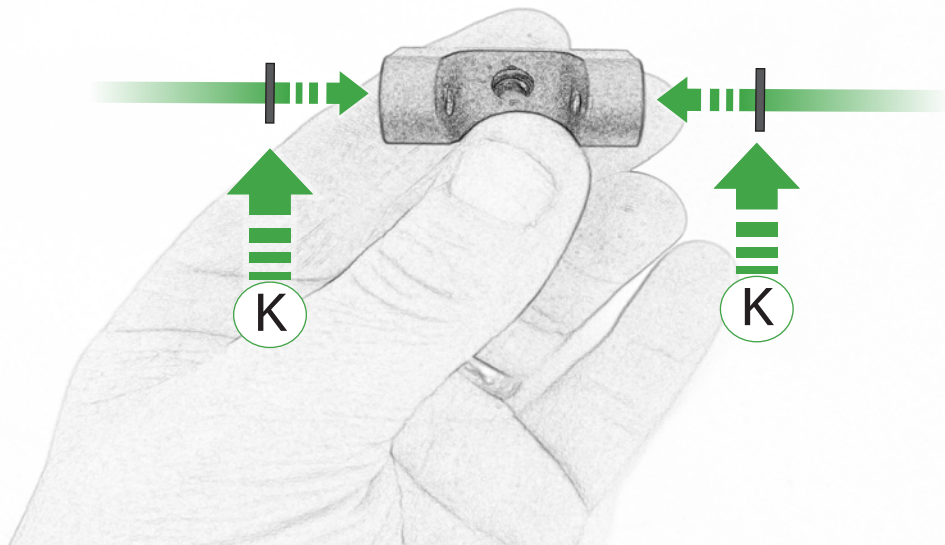

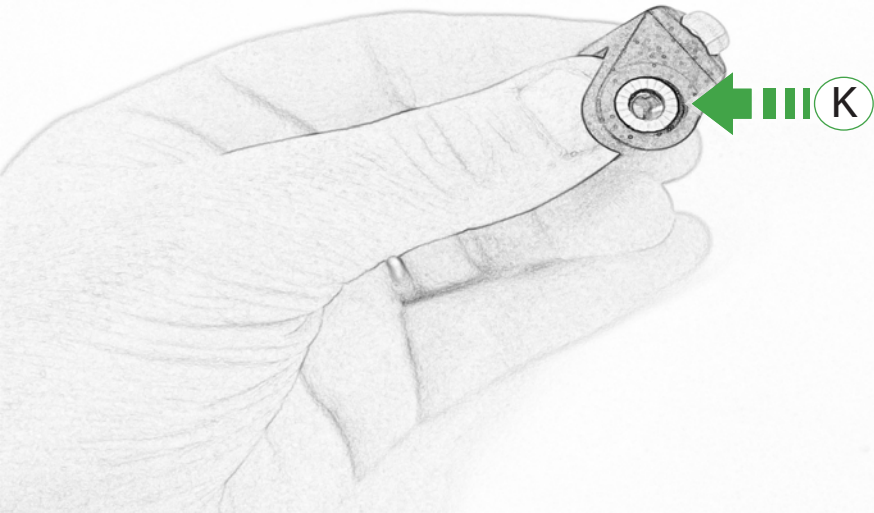

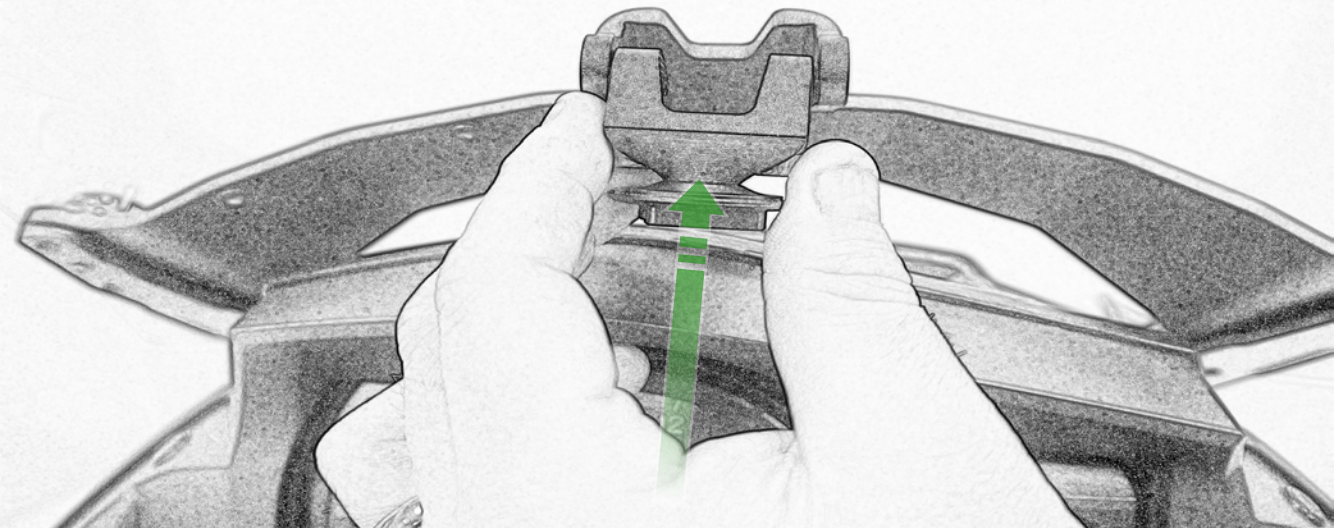

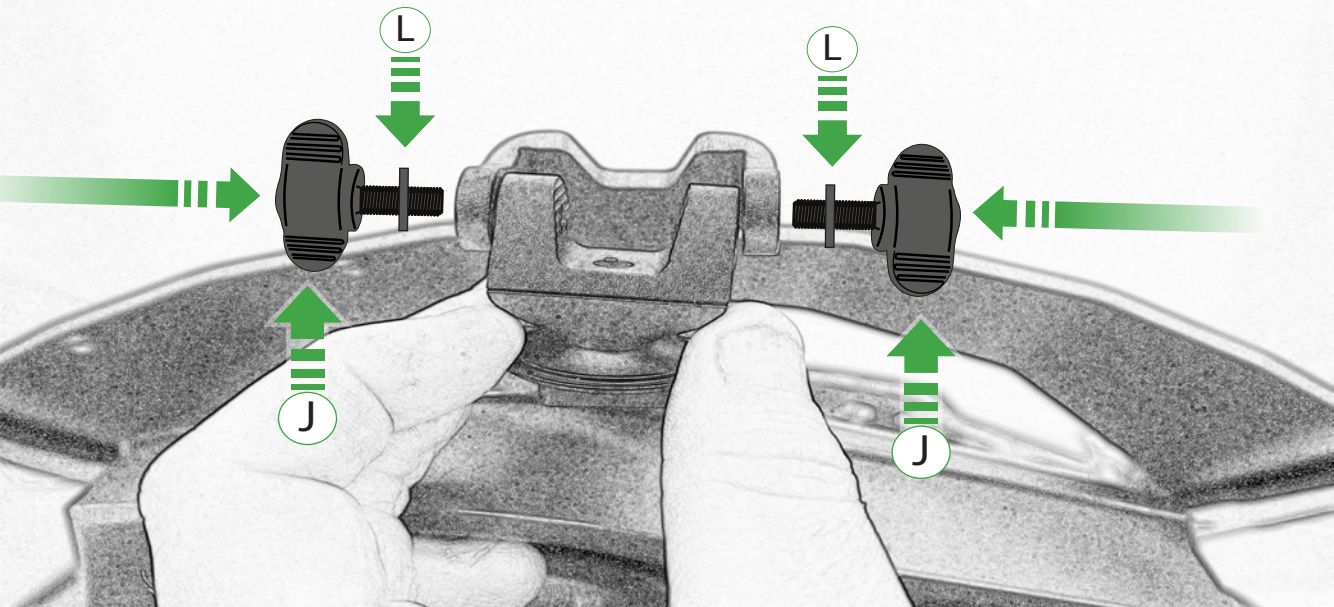



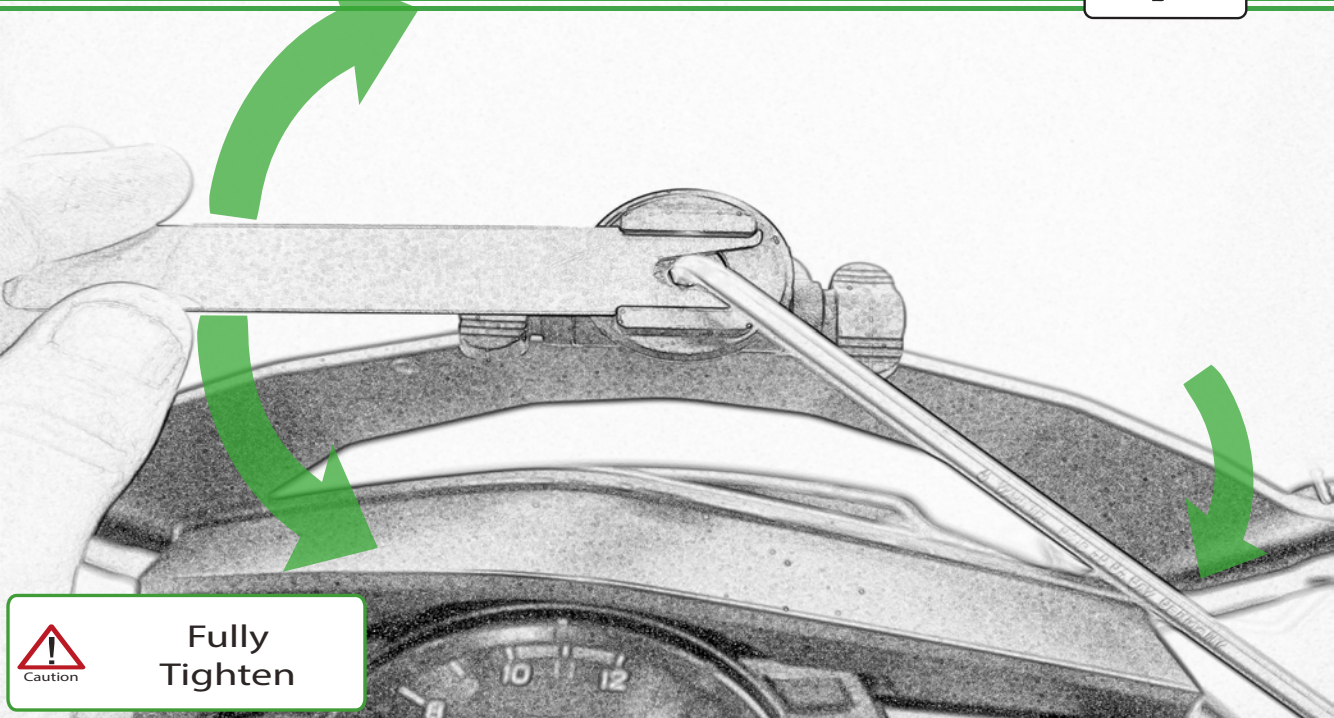

Caution

Fully  
Tighten



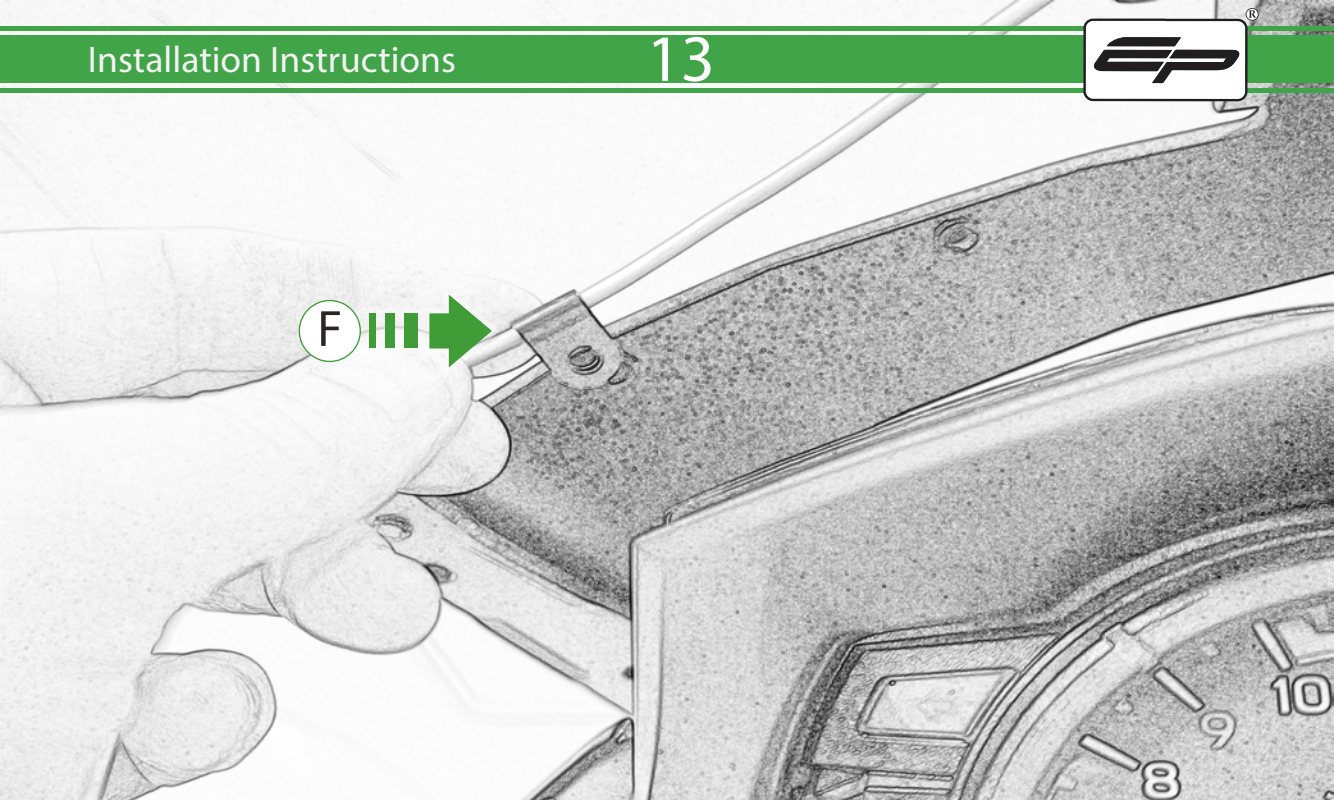

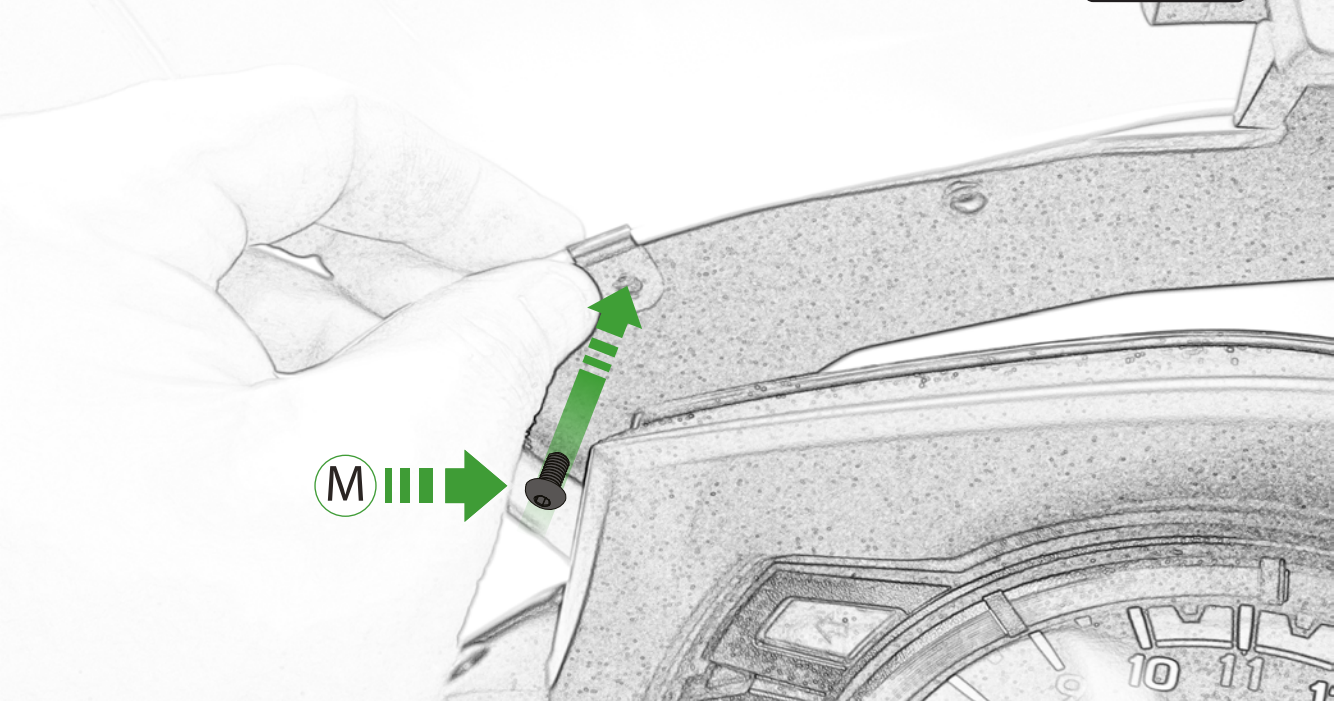

M





## Kit Contents PRN014677-015151

- Ⓐ 1 x M6 x 16 Countersunk Screw
- Ⓑ 1 x Pivot Plate
- Ⓒ 1 x SP Connect Plate
- Ⓓ 1 x Spanner
- Ⓔ 1 x M5 Nut
- Ⓕ 2 x P-clips (No.1)
- Ⓖ 2 x P-clips (No.2)
- Ⓗ 2 x P-clips (No.3)
- Ⓘ 2 x P-clips (No.4)
- Ⓙ 2 x Lobe Screw
- Ⓚ 2 x Locking Washer
- Ⓛ 2 x M5 Black Washer
- Ⓜ 2 x M4 x 5mm Button Head Bolts
- Ⓞ 2 x M5 x 10mm Caphead Bolts

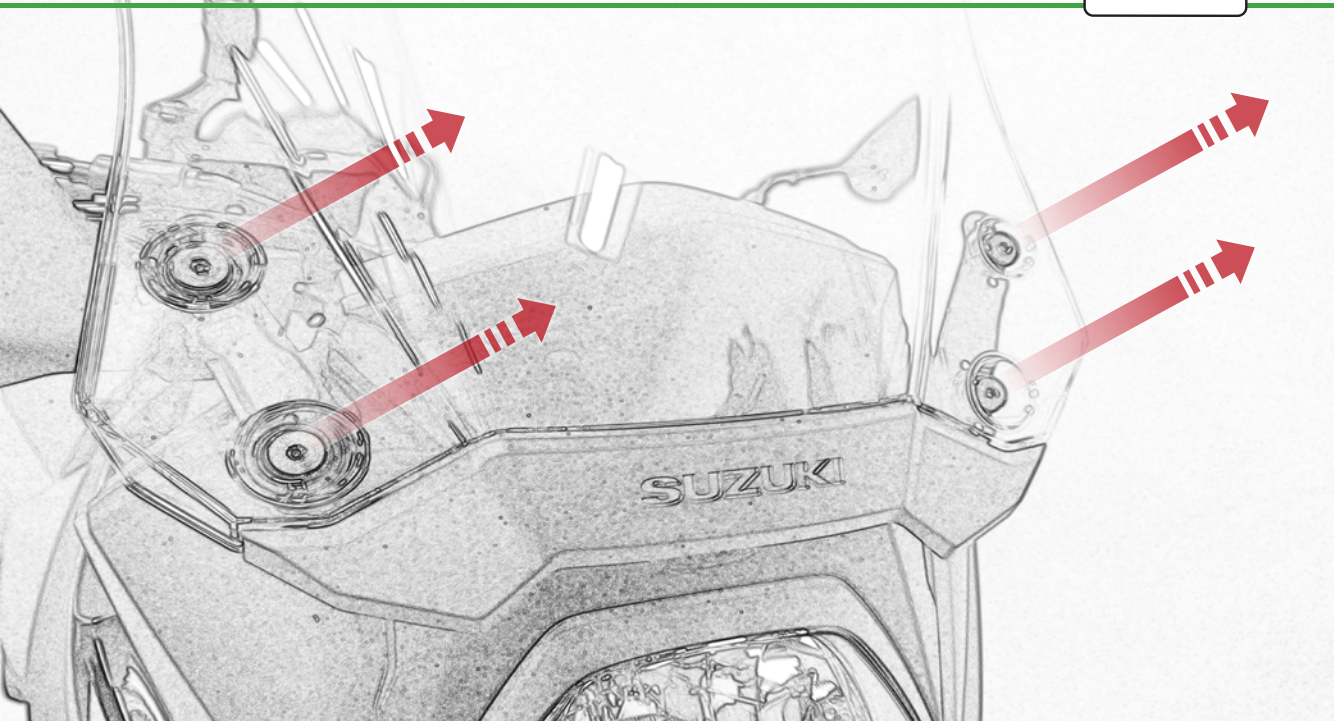

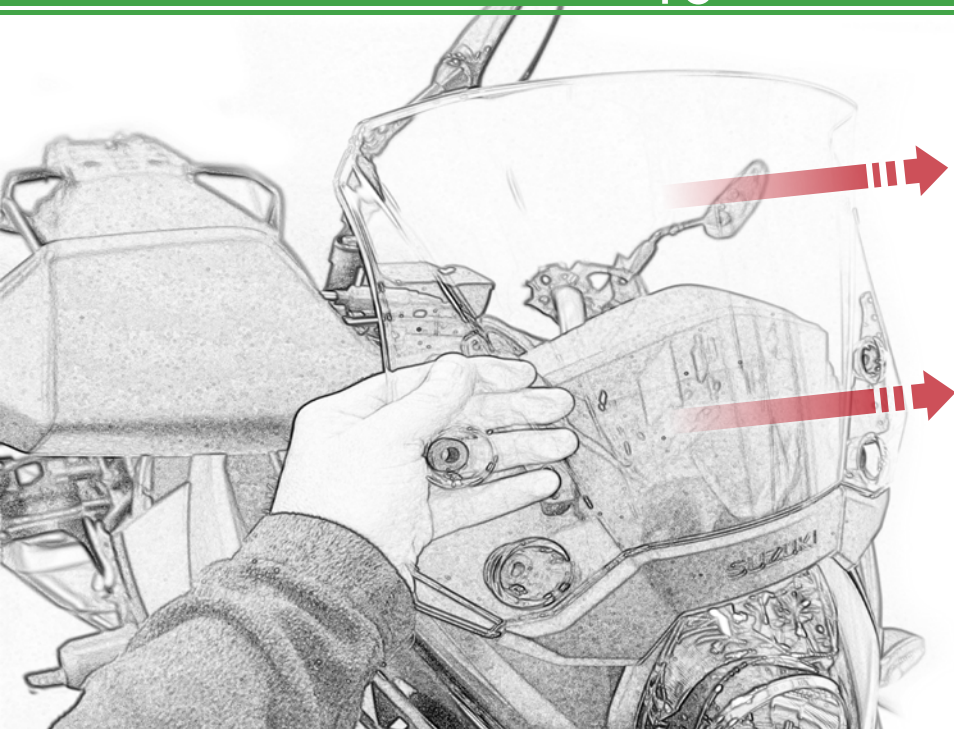



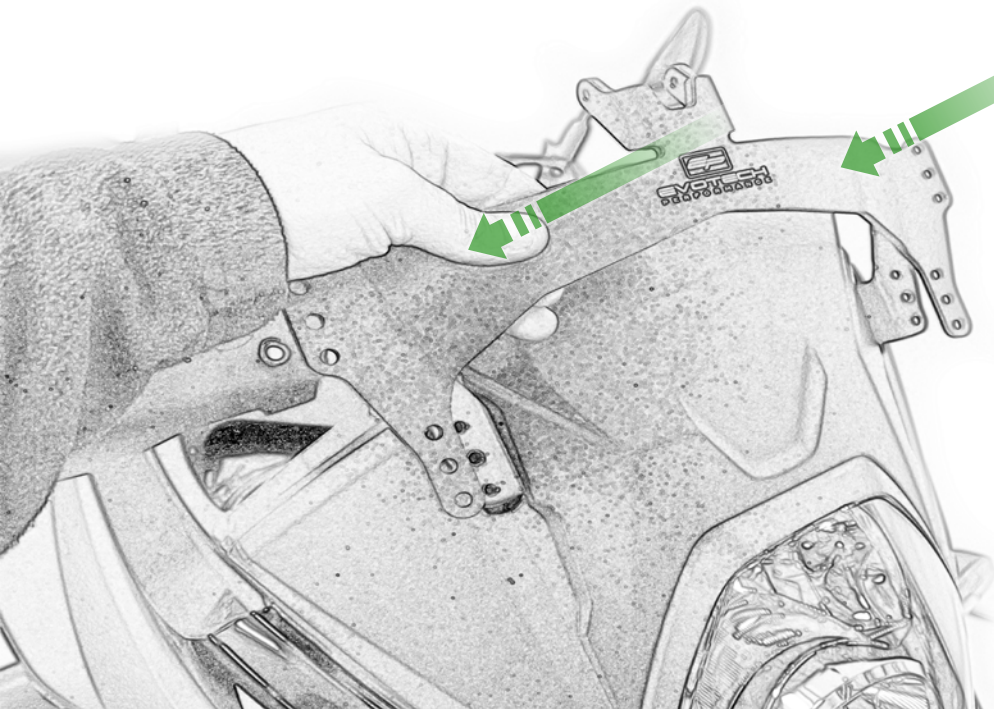

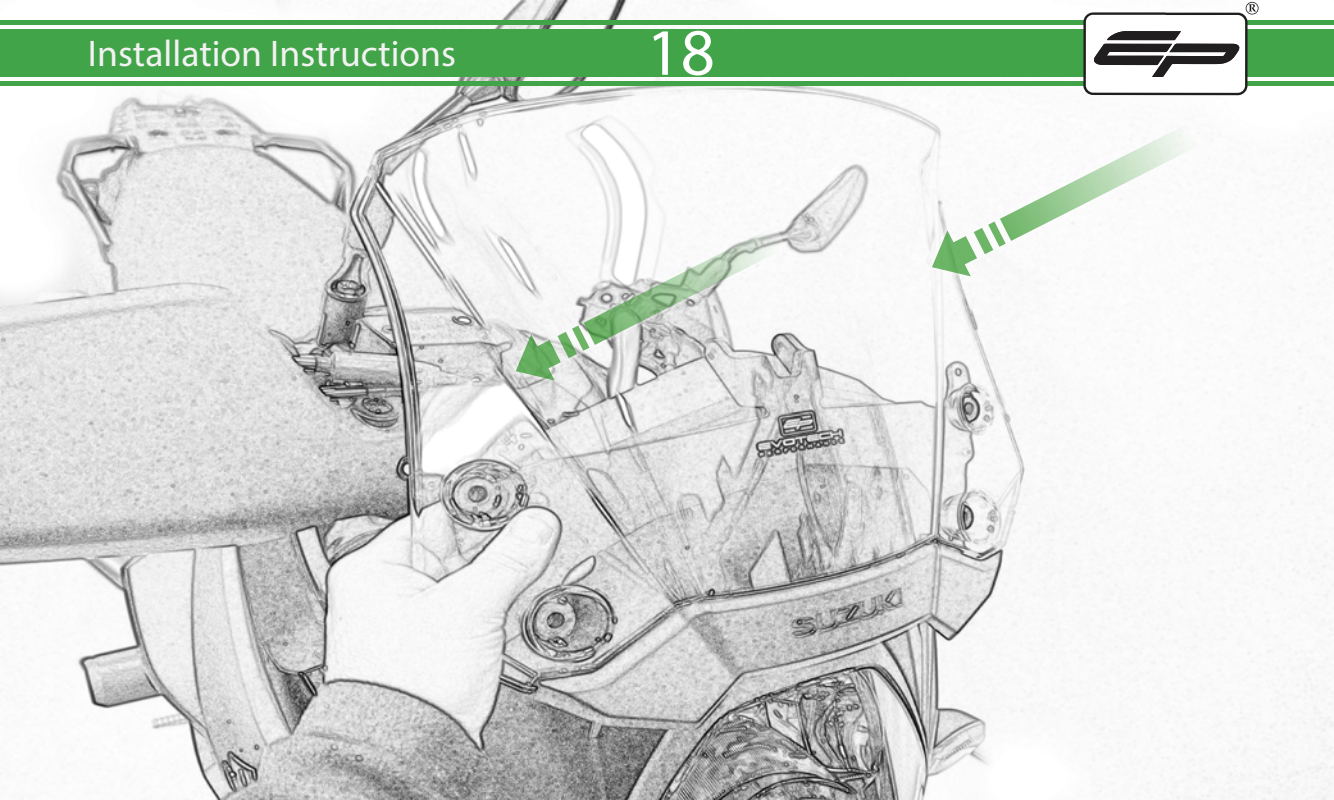



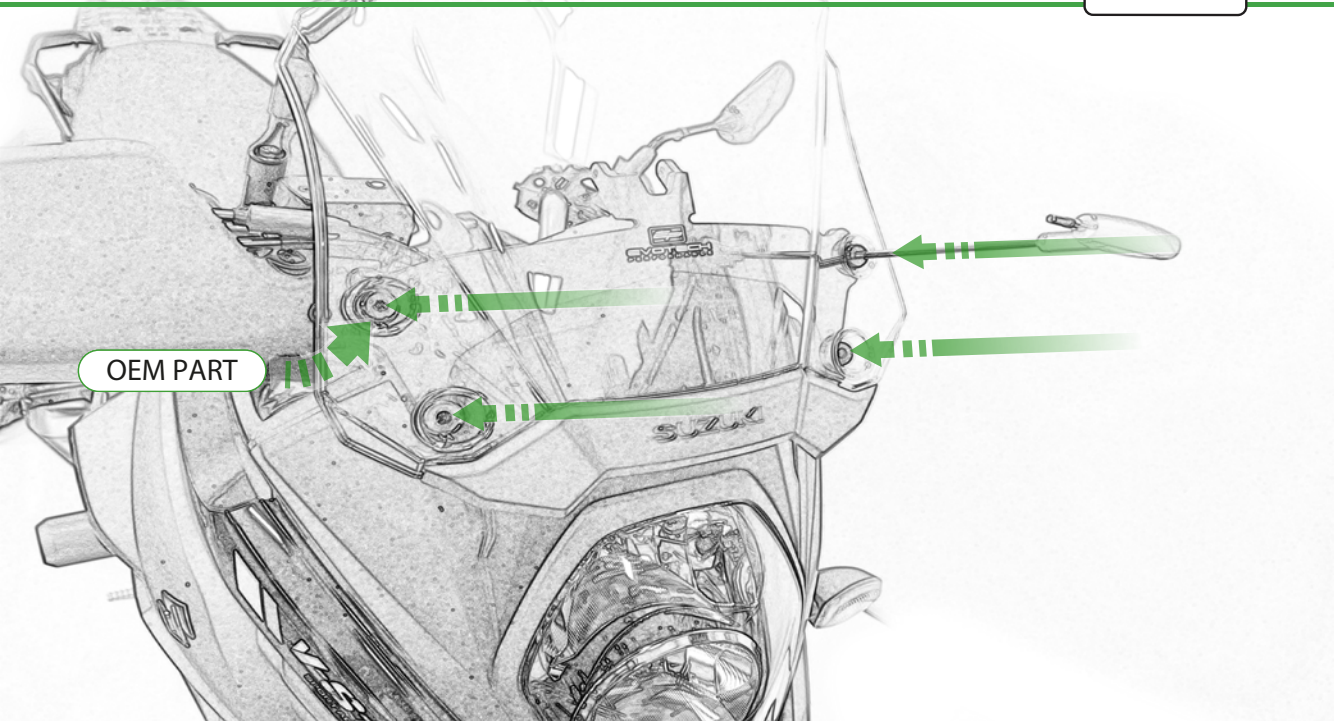

OEM PART

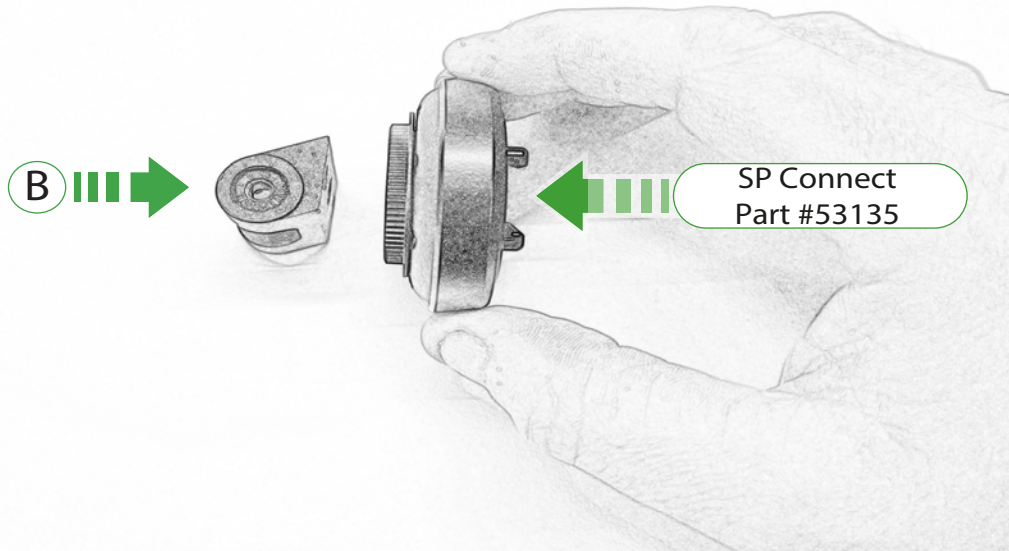

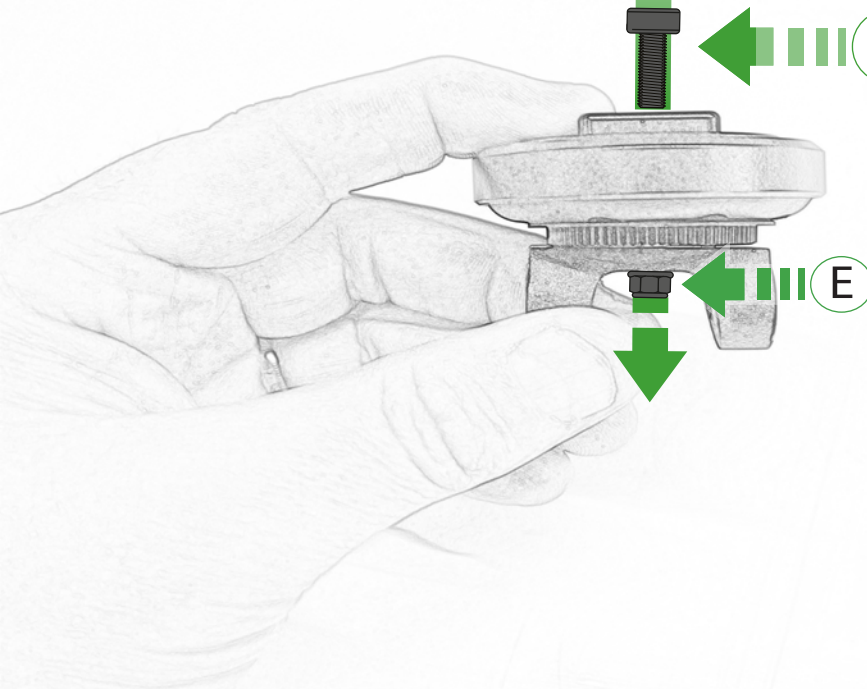

Supplied with  
#53135

E

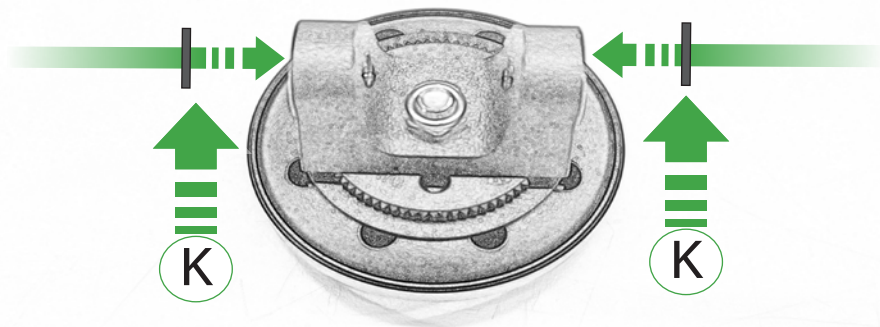

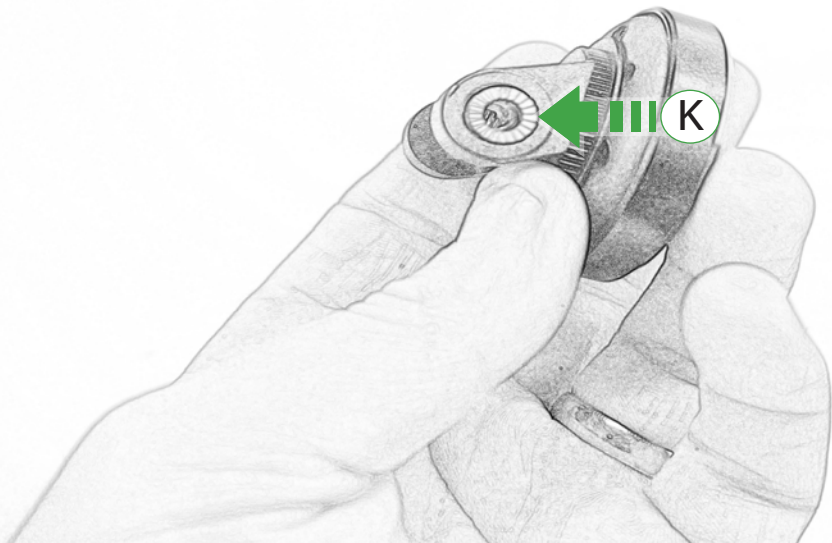

Repeat  
Both Sides

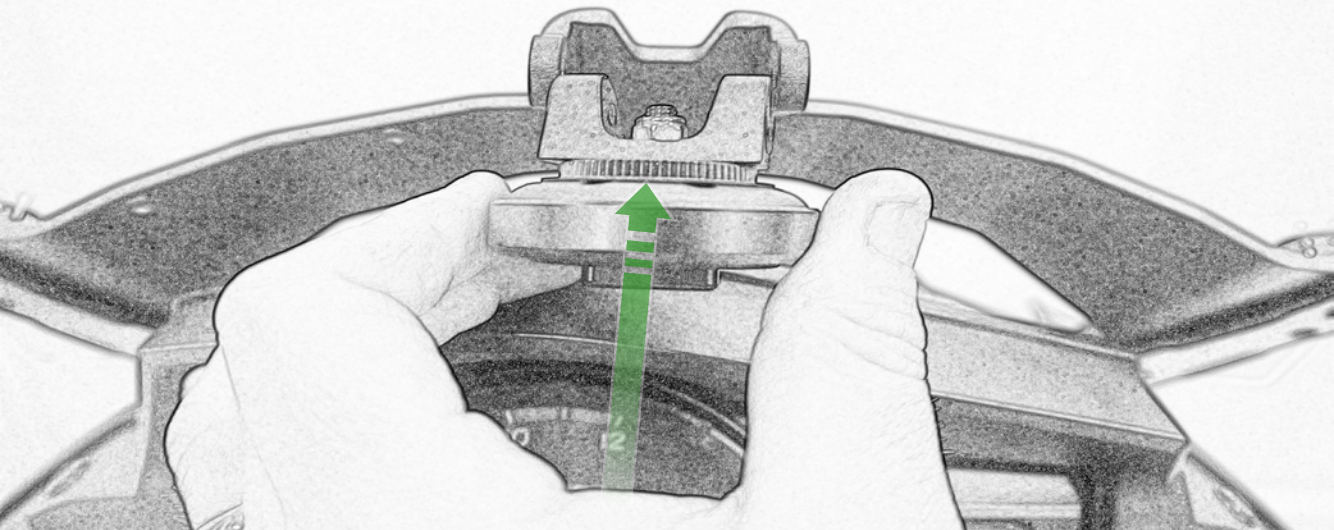

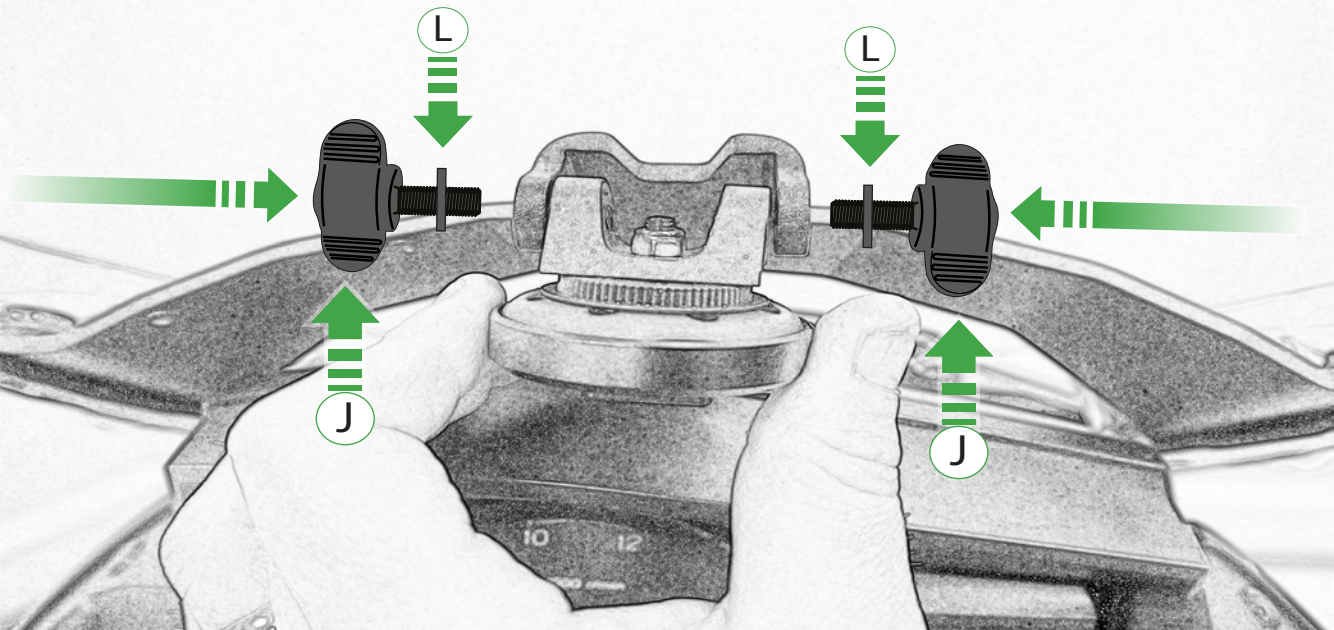



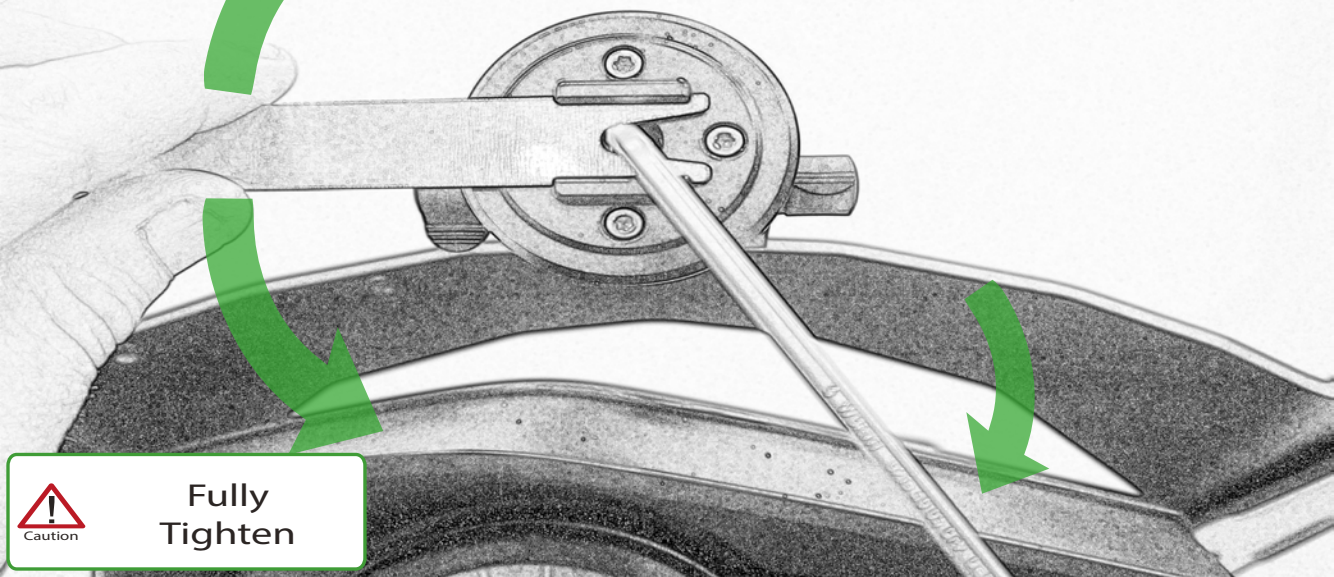

Caution

Fully  
Tighten

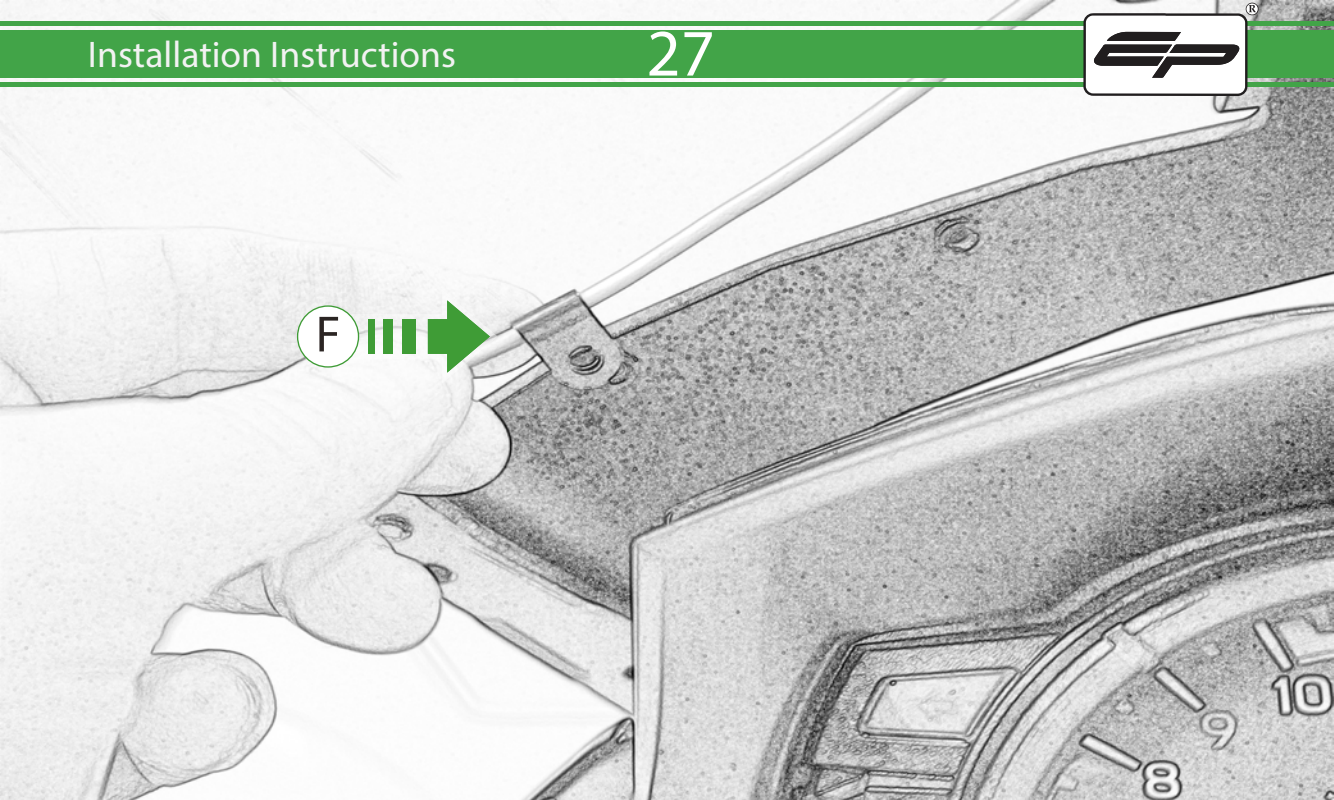

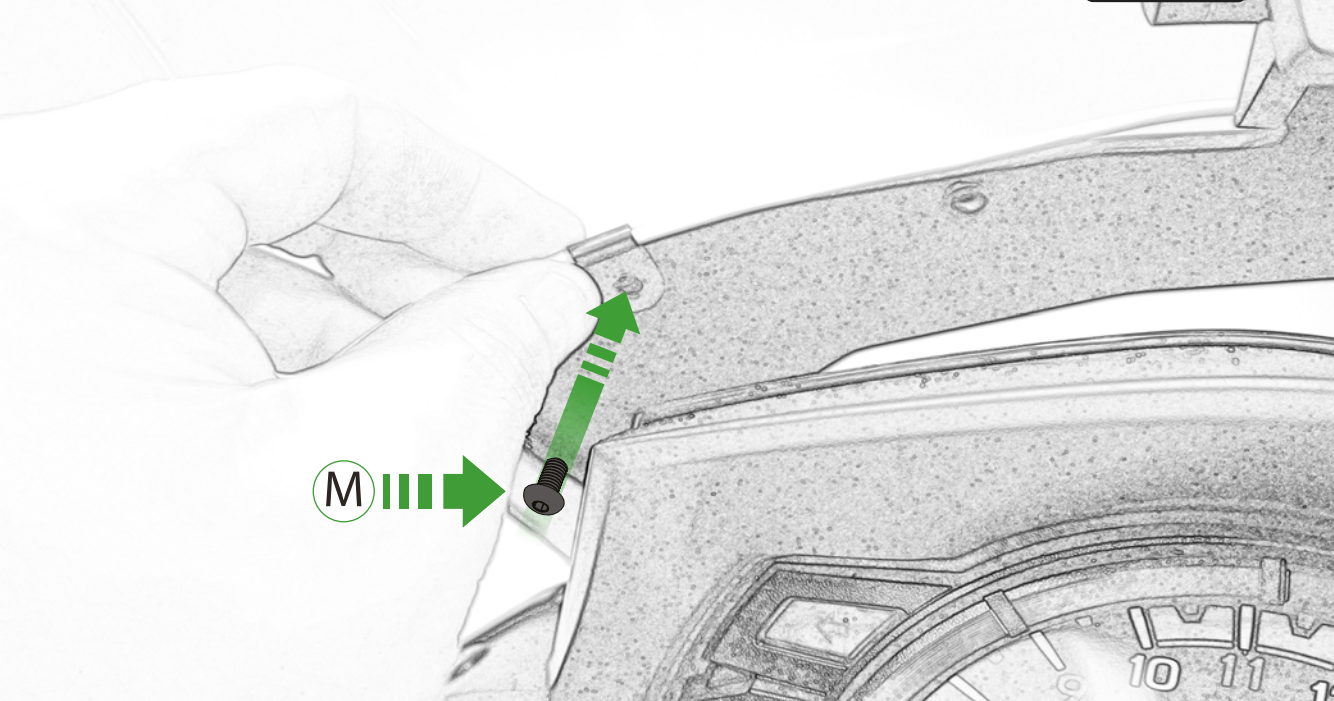

M



## ESSENTIAL CHECKS

It is recommended that periodic inspections are made to ensure that all bolts are tightened to the specified torque settings.

Should the bike be involved in an accident a thorough inspection should be made and any components that have taken an impact, no matter how small, be replaced



**EVOTECH**®  
P E R F O R M A N C E

[www.evotech-performance.com](http://www.evotech-performance.com)