

EVOTECH®
P E R F O R M A N C E

www.evotech-performance.com

Triumph Speed Triple RR
Quad Lock Sat Nav Mount

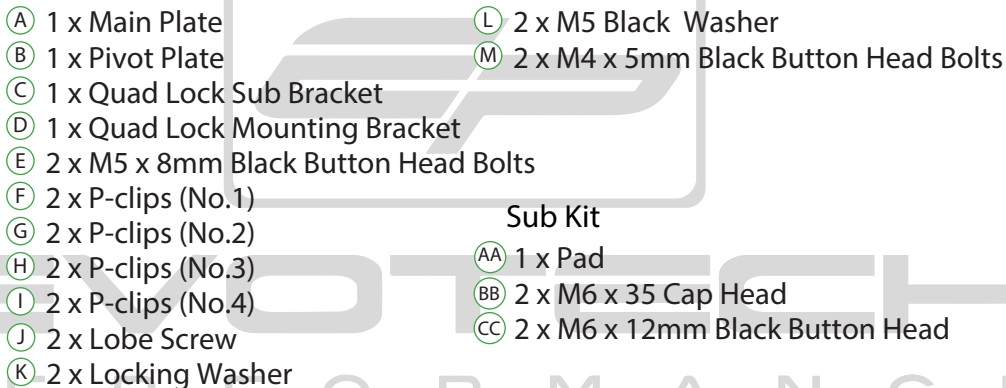

- 
- A large, light grey watermark of the EP Performance logo is centered on the page. The logo consists of a stylized 'EP' inside a rounded rectangle, with the words 'EP PERFORMANCE' written in a large, spaced-out font below it.
- (A) 1 x Main Plate
 - (B) 1 x Pivot Plate
 - (C) 1 x Quad Lock Sub Bracket
 - (D) 1 x Quad Lock Mounting Bracket
 - (E) 2 x M5 x 8mm Black Button Head Bolts
 - (F) 2 x P-clips (No.1)
 - (G) 2 x P-clips (No.2)
 - (H) 2 x P-clips (No.3)
 - (I) 2 x P-clips (No.4)
 - (J) 2 x Lobe Screw
 - (K) 2 x Locking Washer
 - (L) 2 x M5 Black Washer
 - (M) 2 x M4 x 5mm Black Button Head Bolts
- Sub Kit
- (AA) 1 x Pad
 - (BB) 2 x M6 x 35 Cap Head
 - (CC) 2 x M6 x 12mm Black Button Head

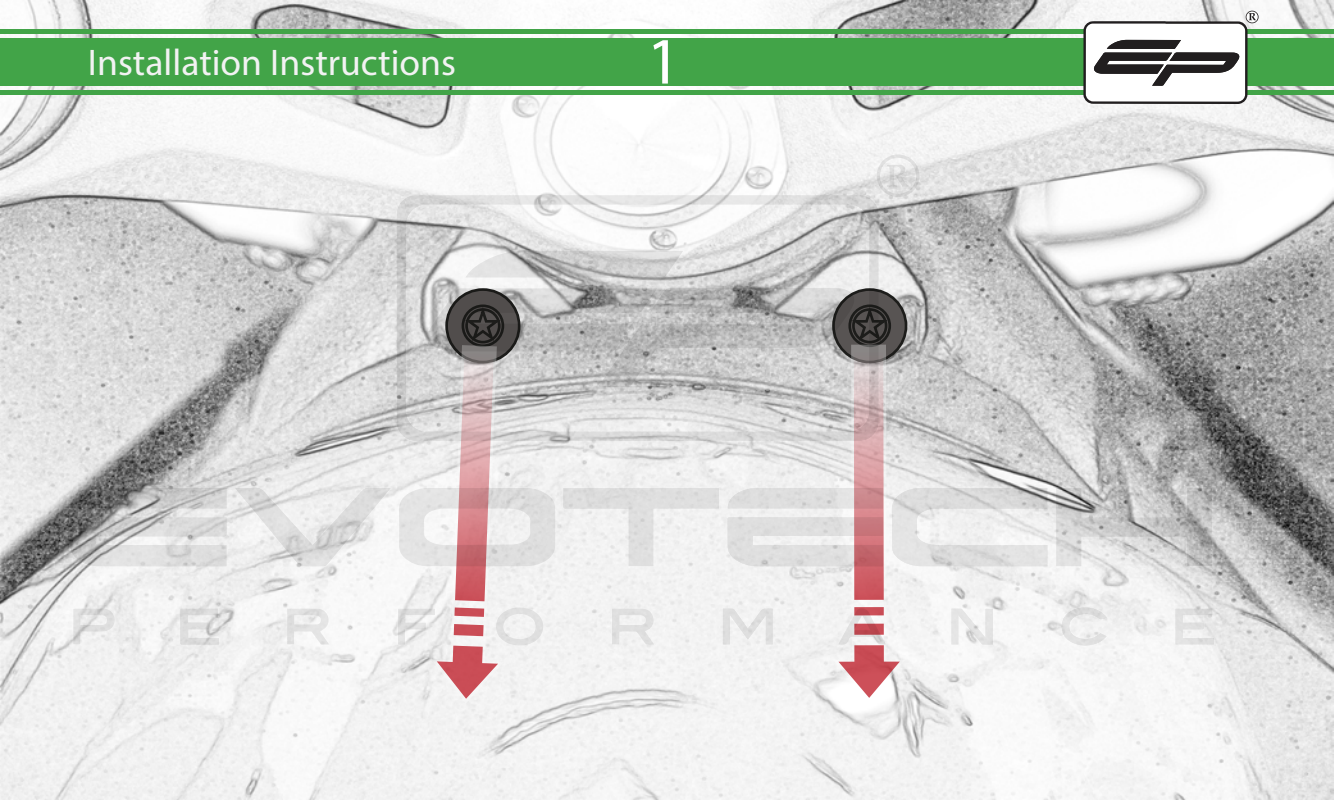



AA 2

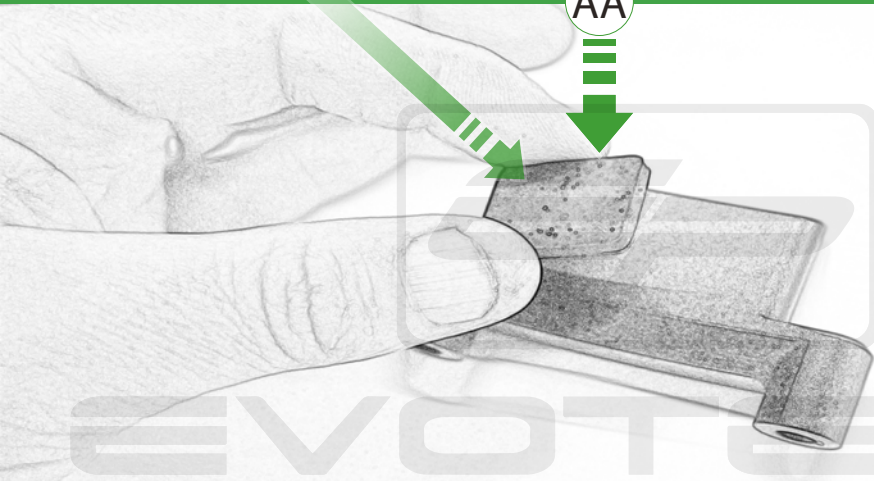

EVOTECH[®]
P E R F O R M A N C E

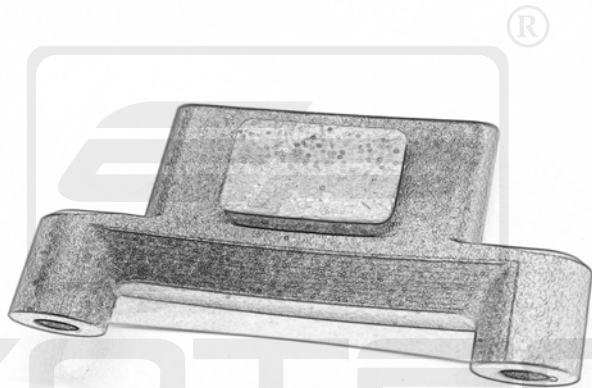

EVOTECH[®]
P E R F O R M A N C E[®]

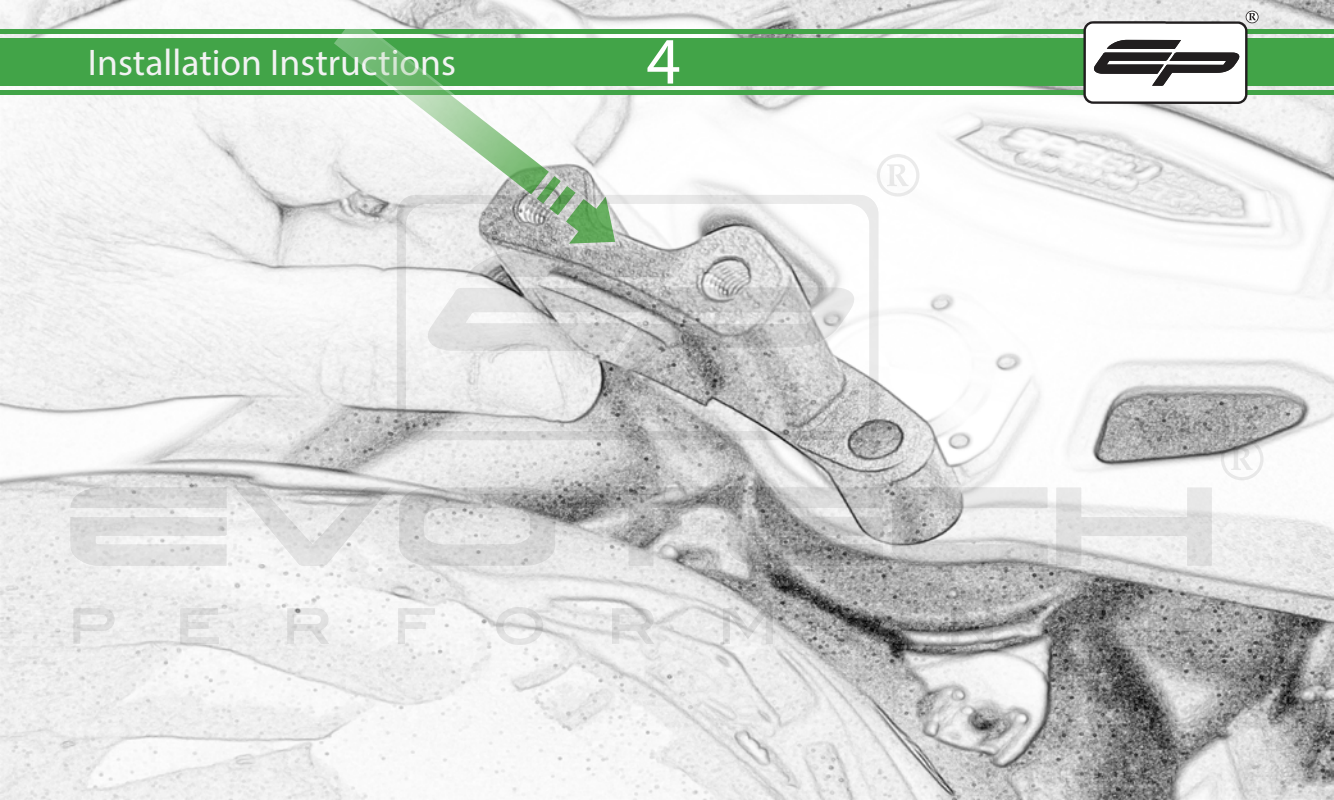



BB

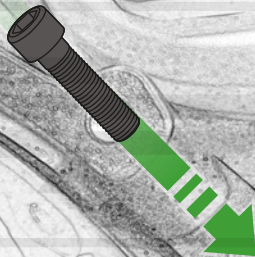

EVOT
PERFORMANCE



BB 



EVO TECH
PERFORMANCE

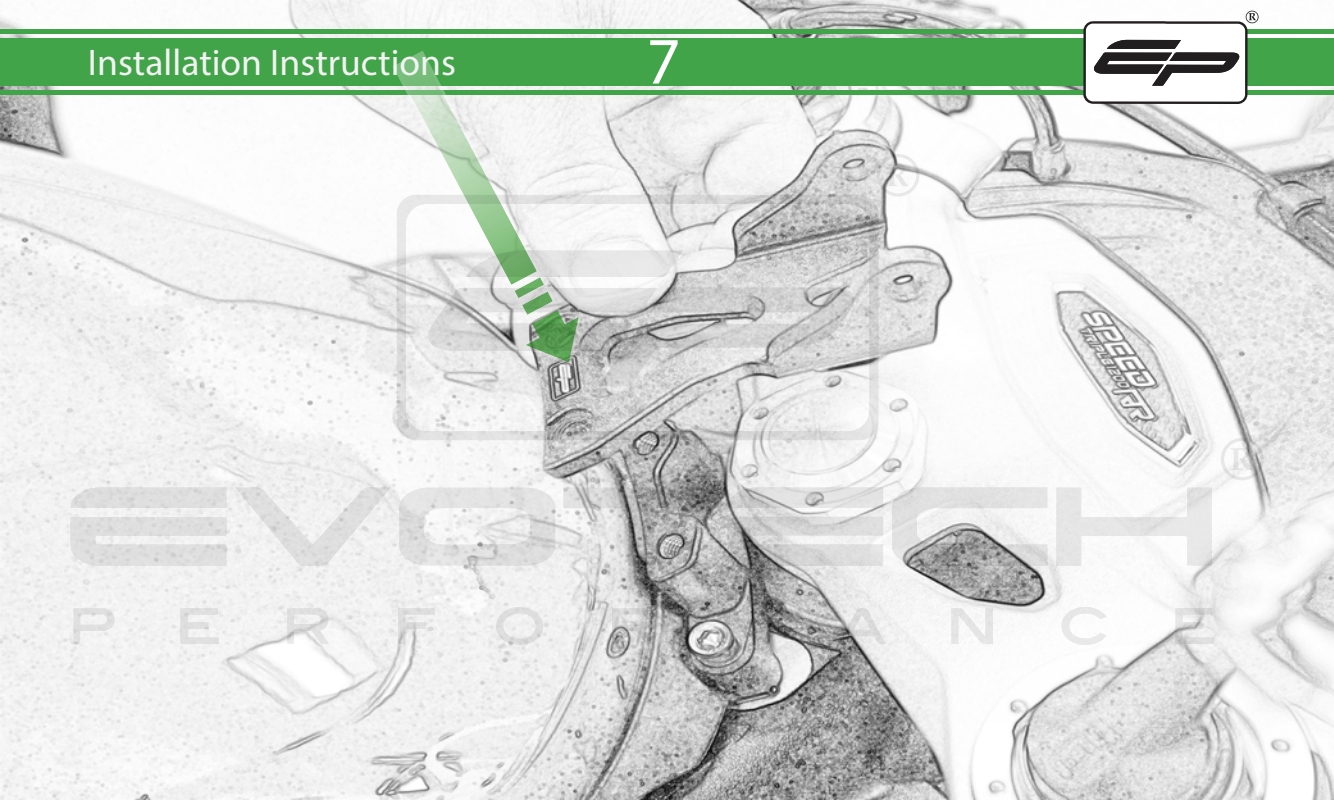

EVOLUTION PERFORMANCE

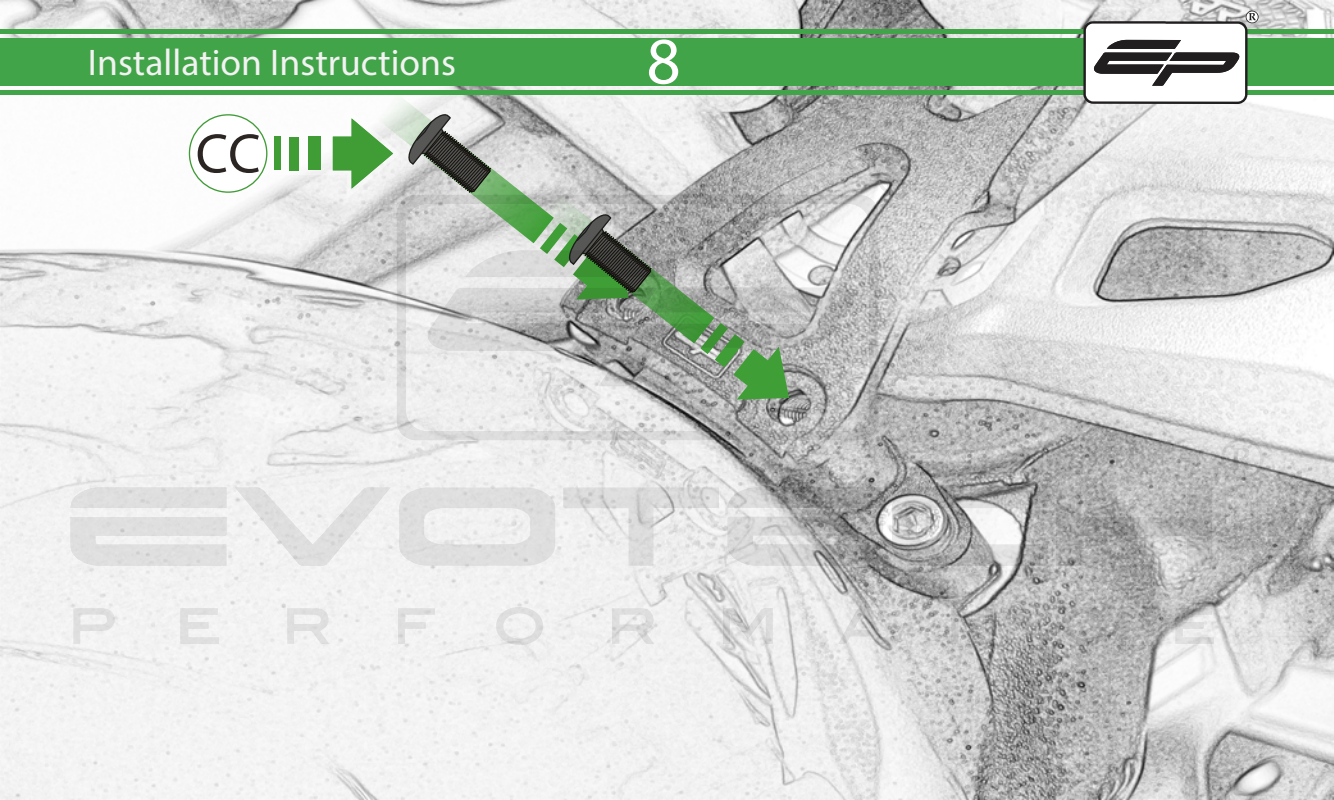

EVO
PERFORMANCE



EVOTECH
P E R F O R M A N C E

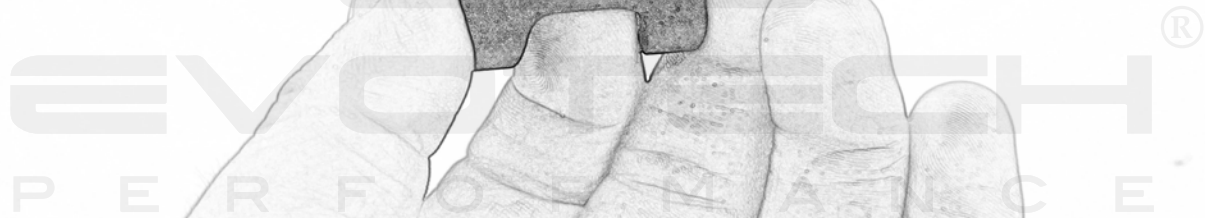
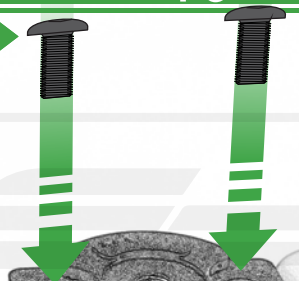

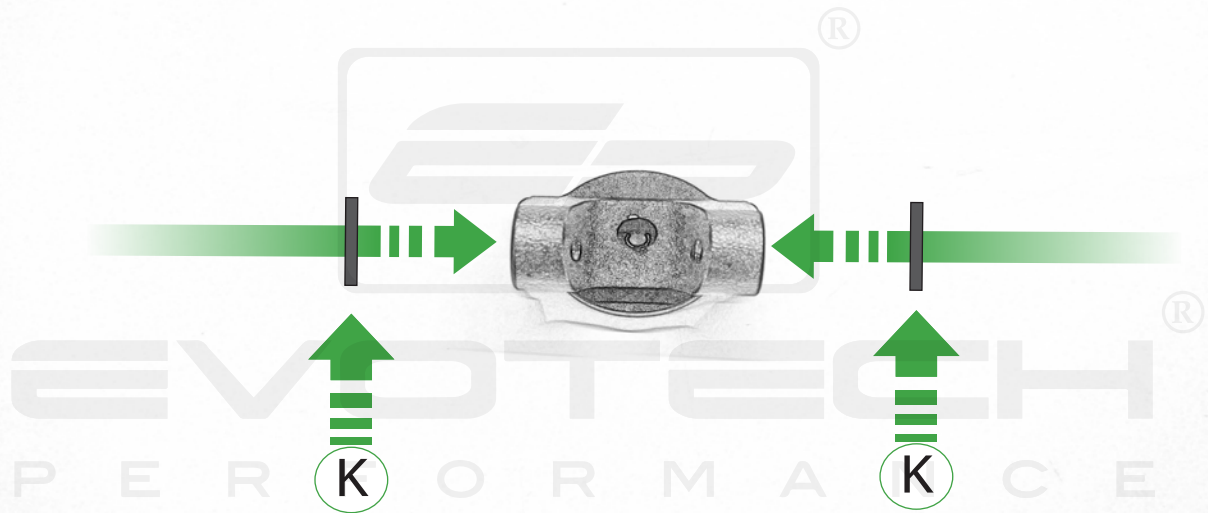



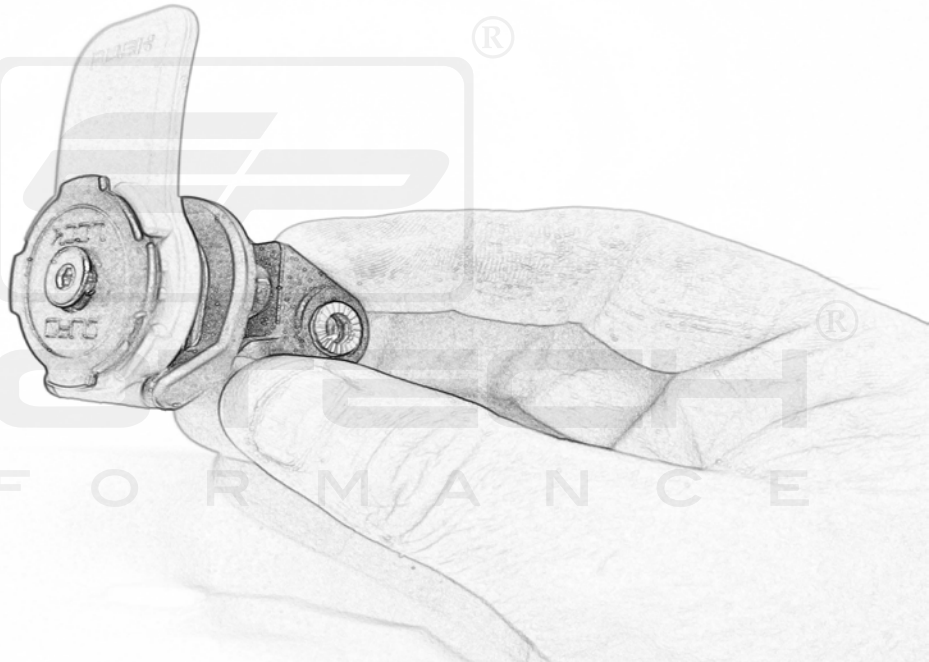

EVO
PERFORMANCE

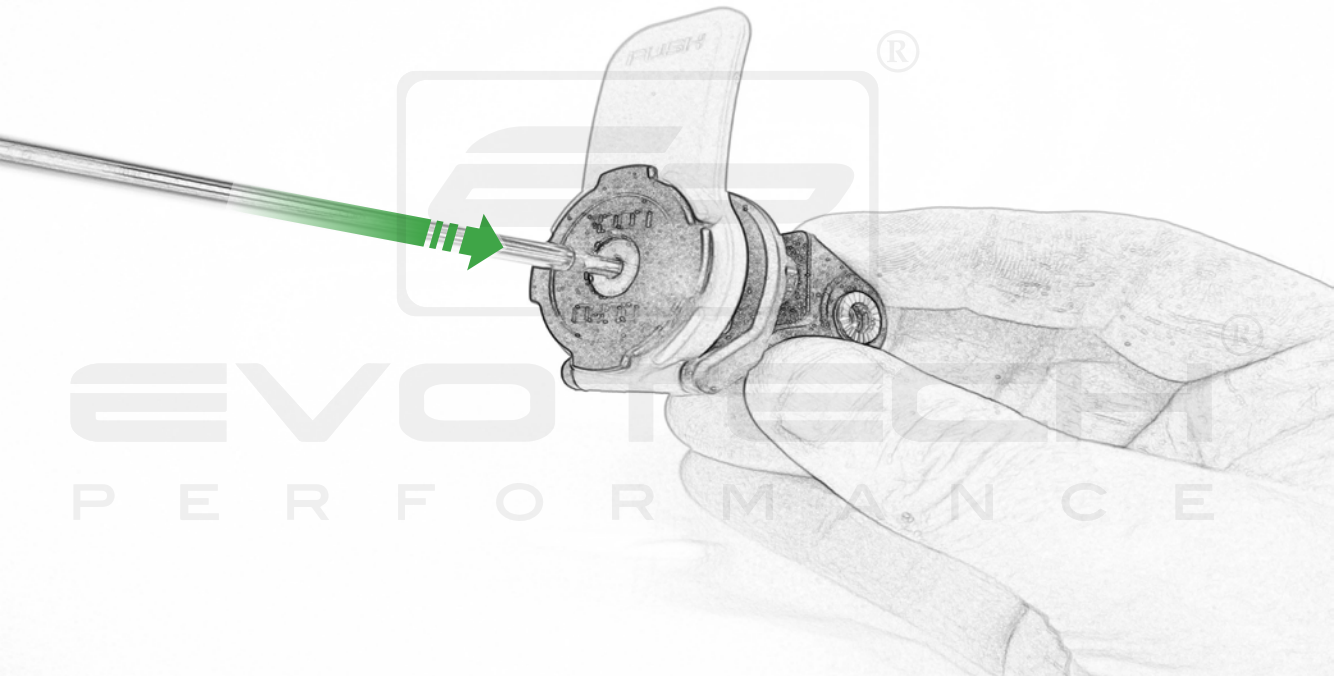

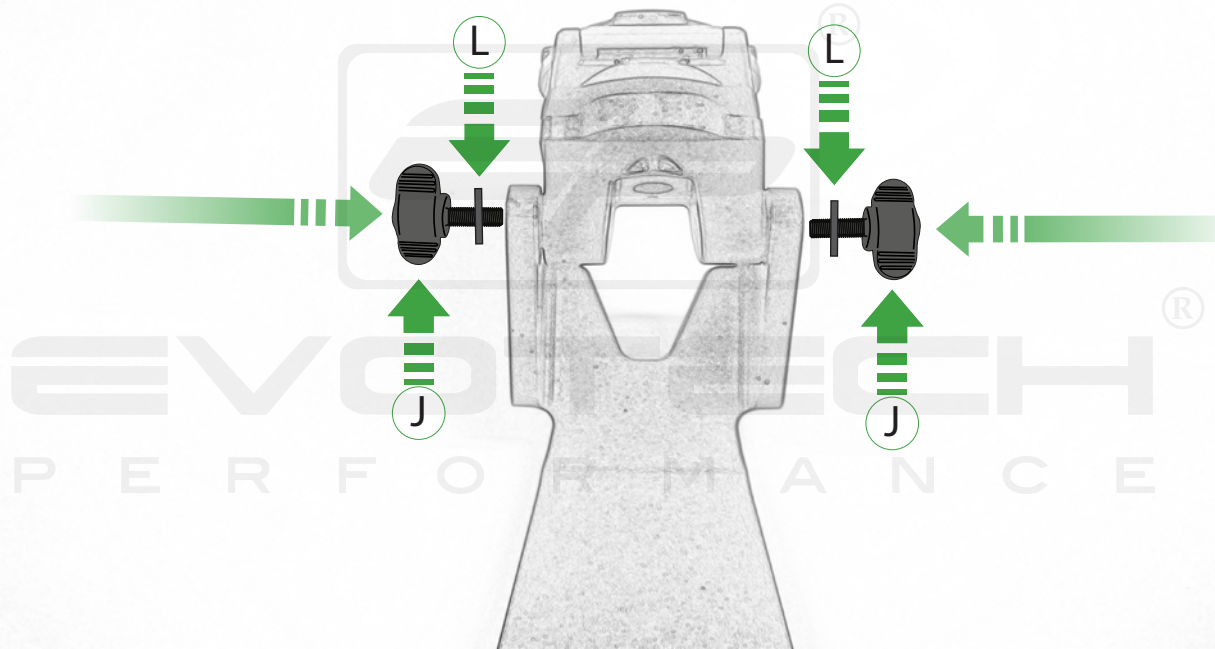



ESSENTIAL CHECKS



It is recommended that periodic inspections are made to ensure that all bolts are tightened to the specified torque settings.

Should the bike be involved in an accident a thorough inspection should be made and any components that have taken an impact, no matter how small, be replaced



EVOTECH®
P E R F O R M A N C E

www.evotech-performance.com