



EVOTECH®
P E R F O R M A N C E

BMW F 900 XR / TE

Quad Lock Sat Nav Mount

Installation Instructions



Kit Contents PRN014568-015019

- (A) 1 x Main Plate
- (B) 1 x Pivot Plate
- (C) 1 x Quad Lock Sub Bracket
- (D) 1 x Quad Lock Mounting Bracket Sub Kit
- (E) 2 x M5 x 8mm Button Head Bolts
- (F) 2 x P-clips (No.1)
- (G) 2 x P-clips (No.2)
- (H) 2 x P-clips (No.3)
- (I) 2 x P-clips (No.4)
- (J) 2 x Lobe Screw
- (K) 2 x Locking Washer
- (L) 2 x M5 Black Washer
- (M) 2 x M4 x 5mm Black Button Head Bolts
- (N) 4 x M6 x 40 Caphead
- (O) 4 x M5 x 10mm Button Head Bolts

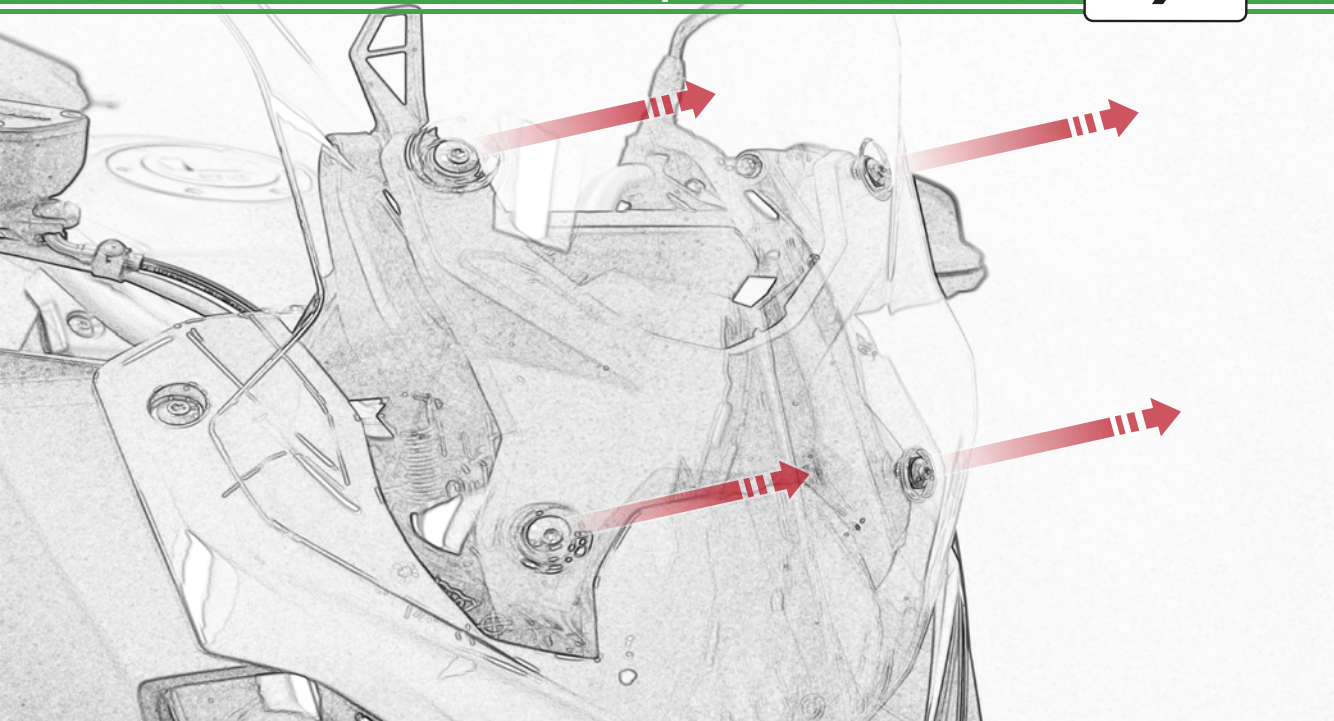





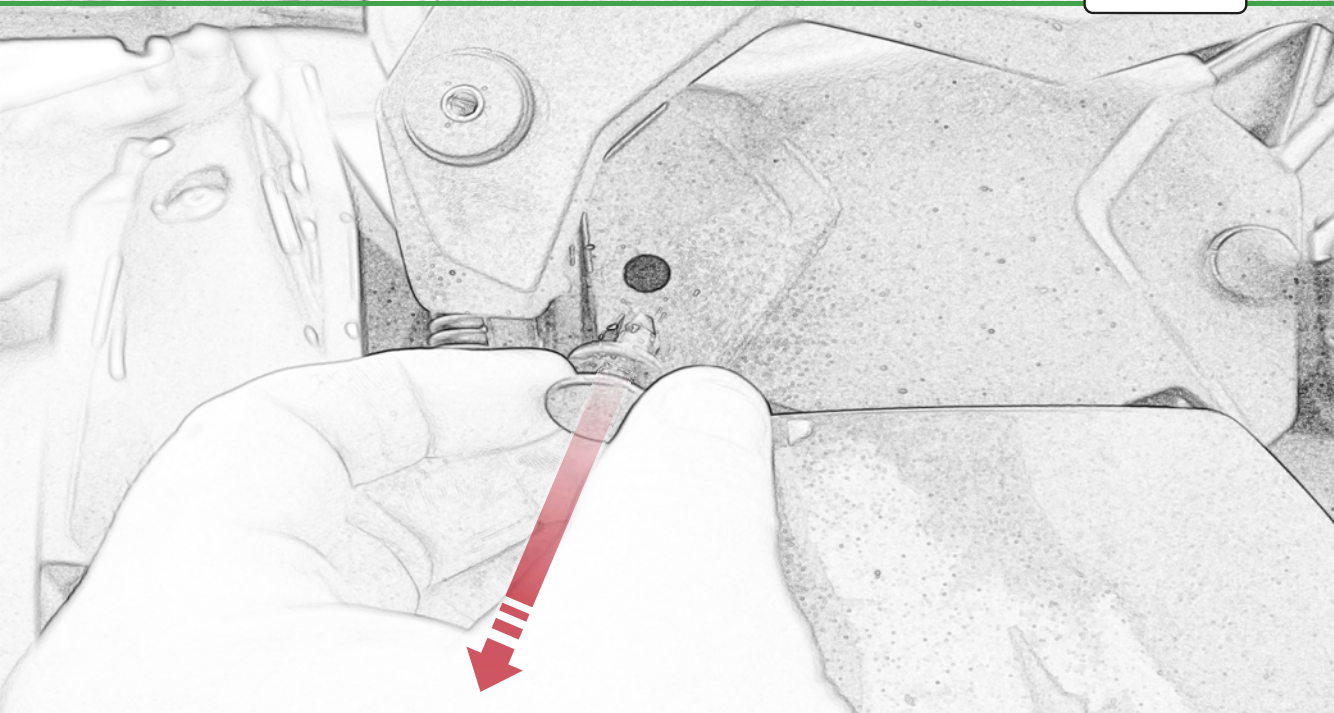

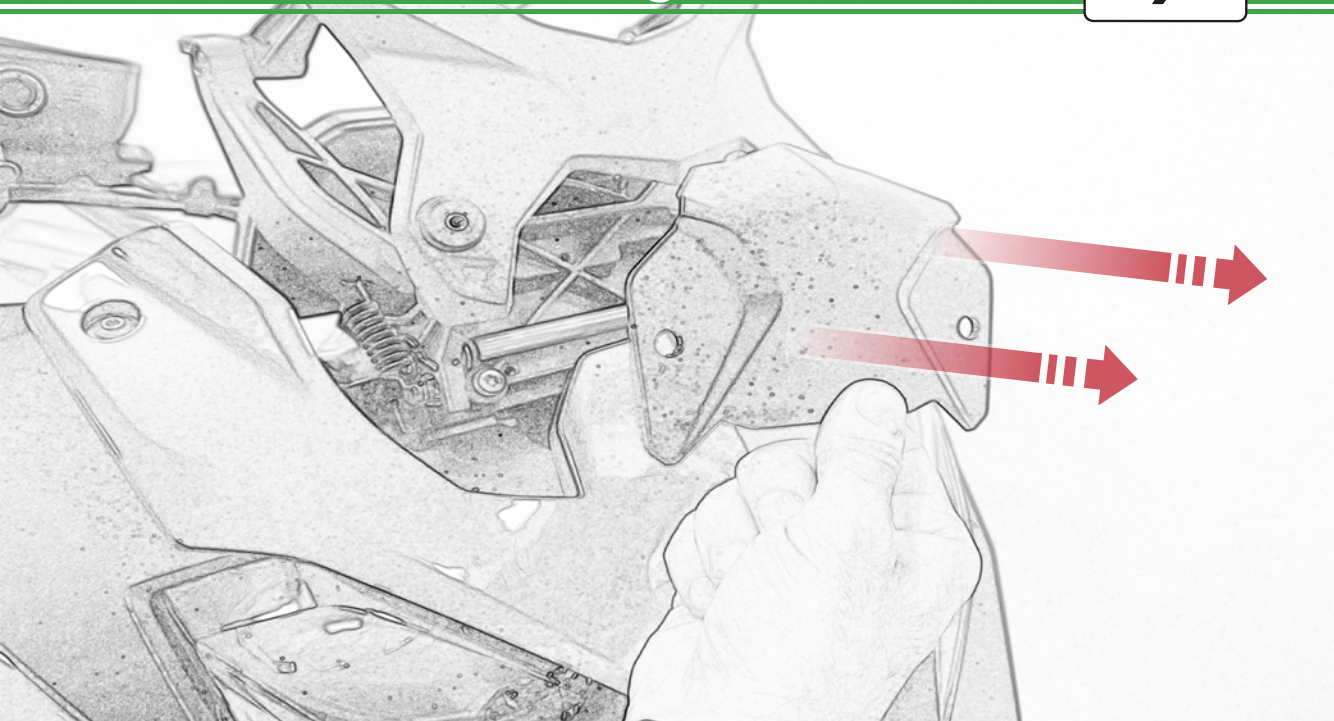

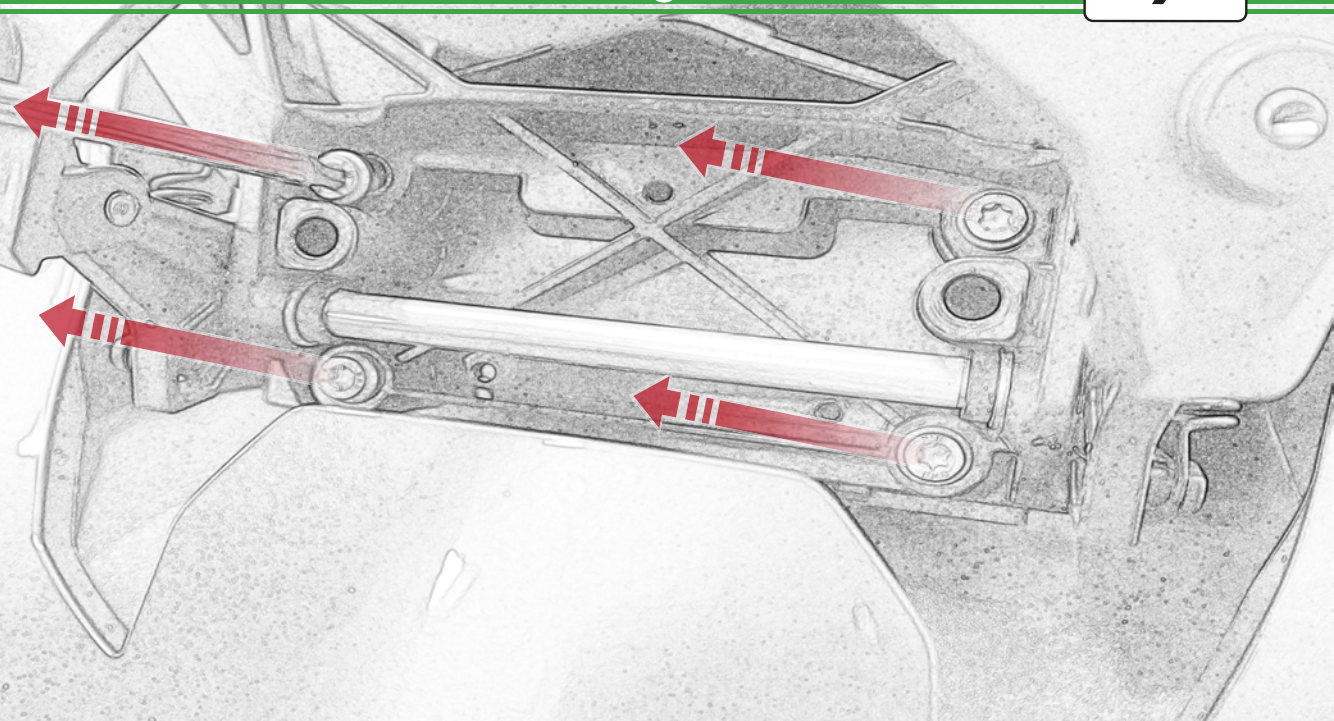

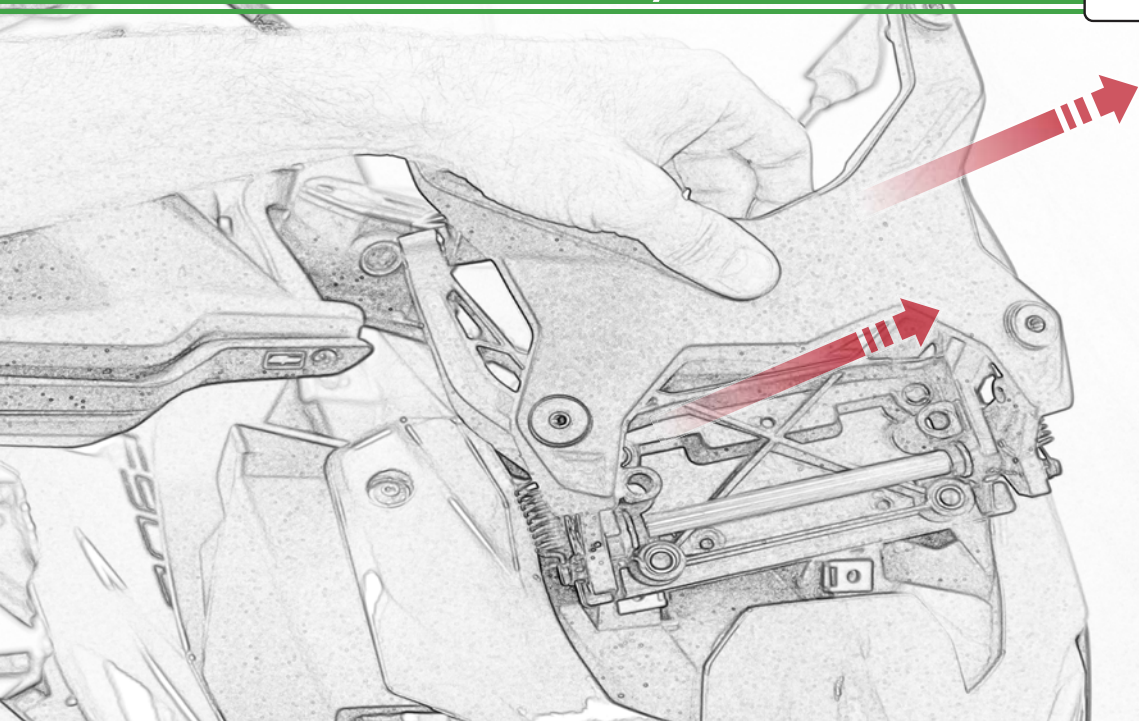

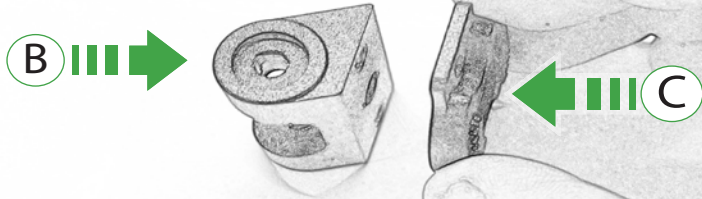



⑤ IIII →



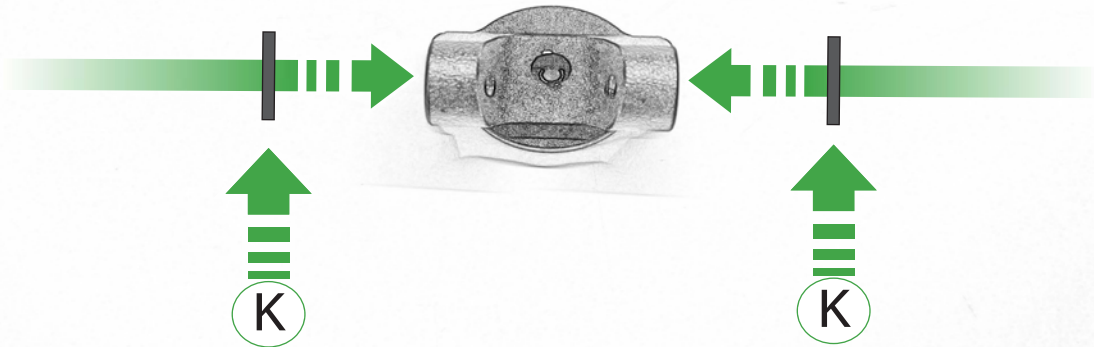

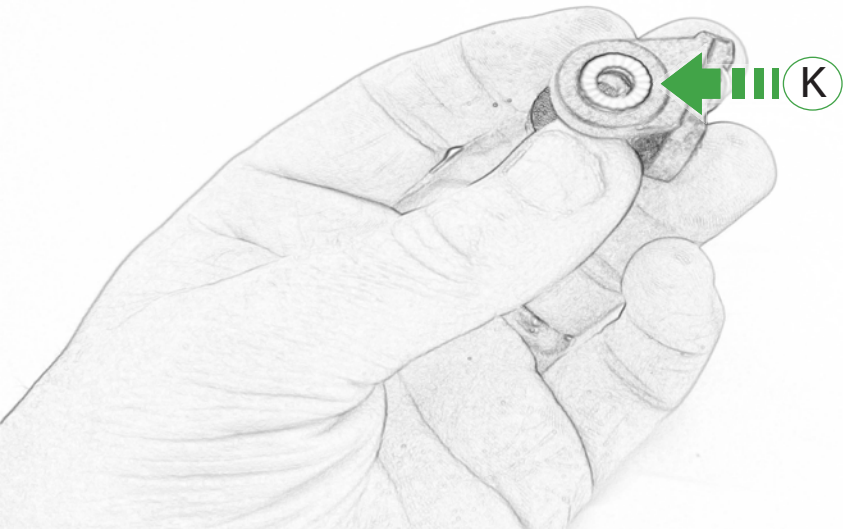



A

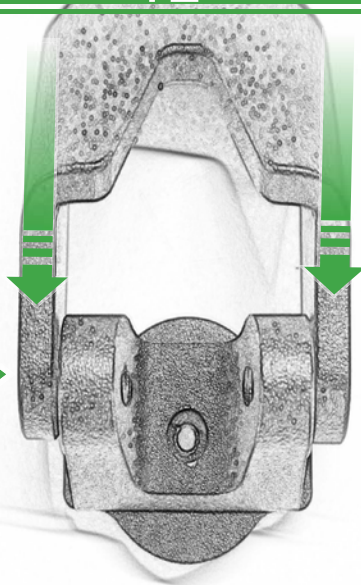

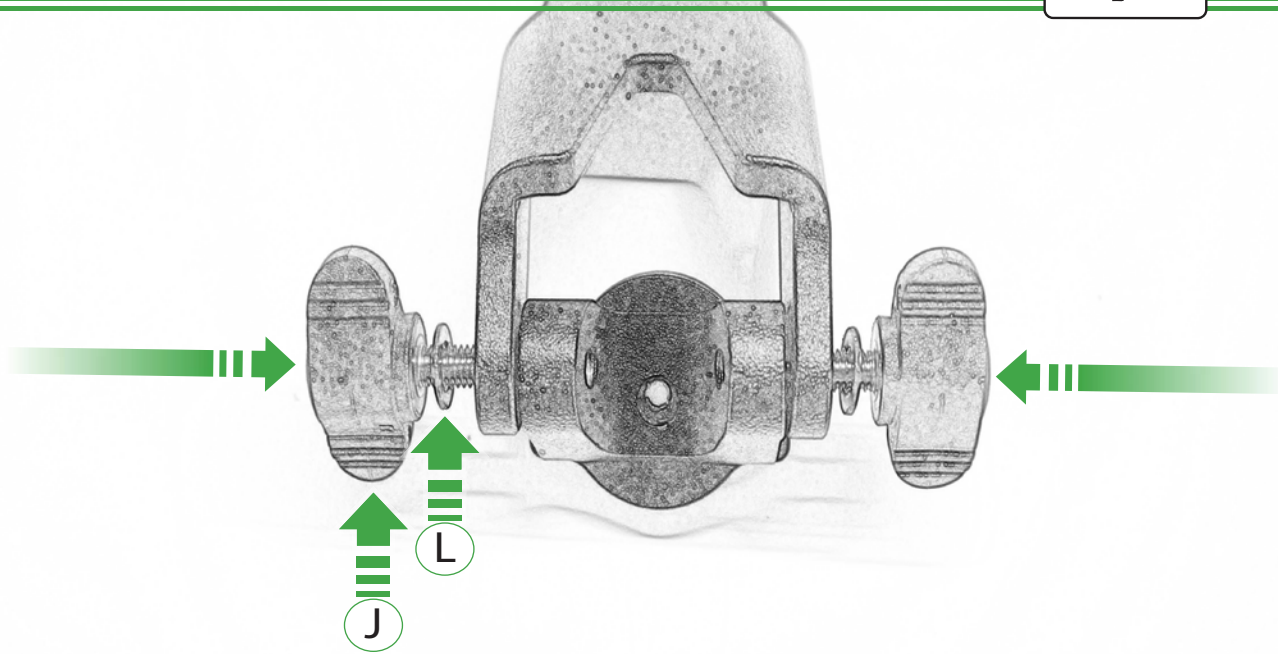

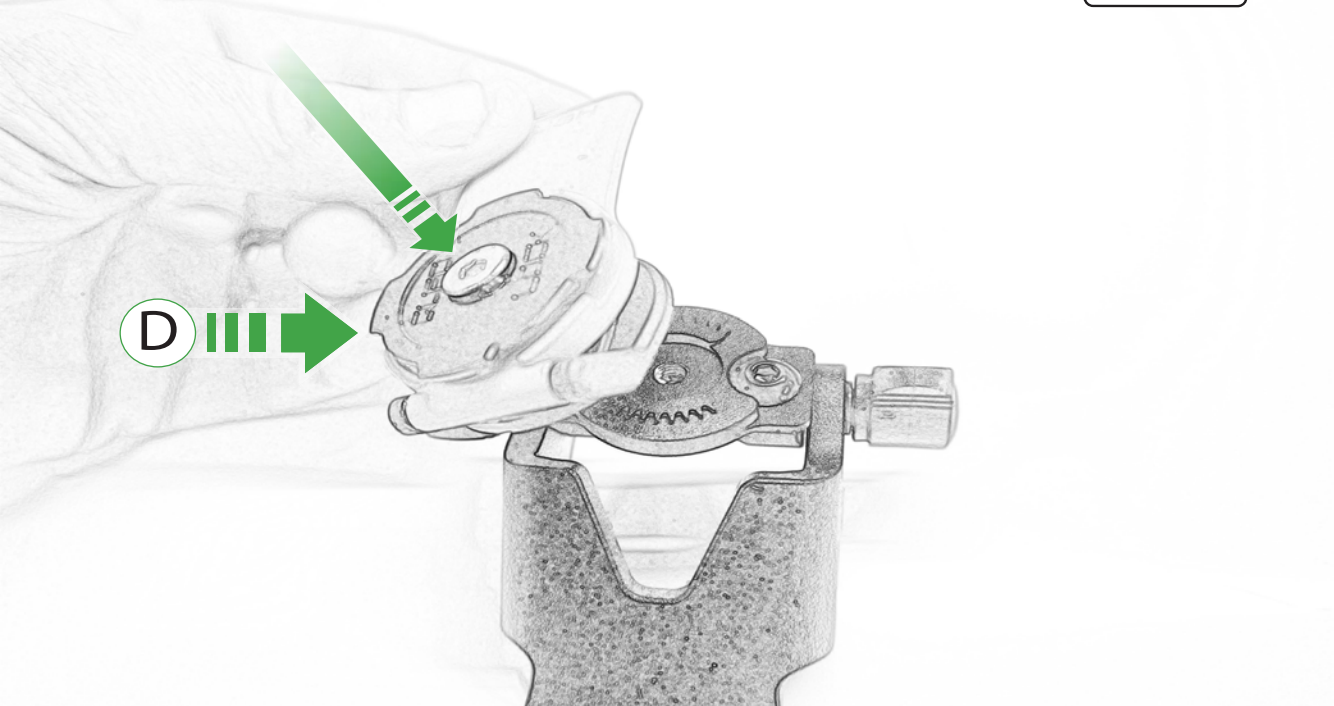

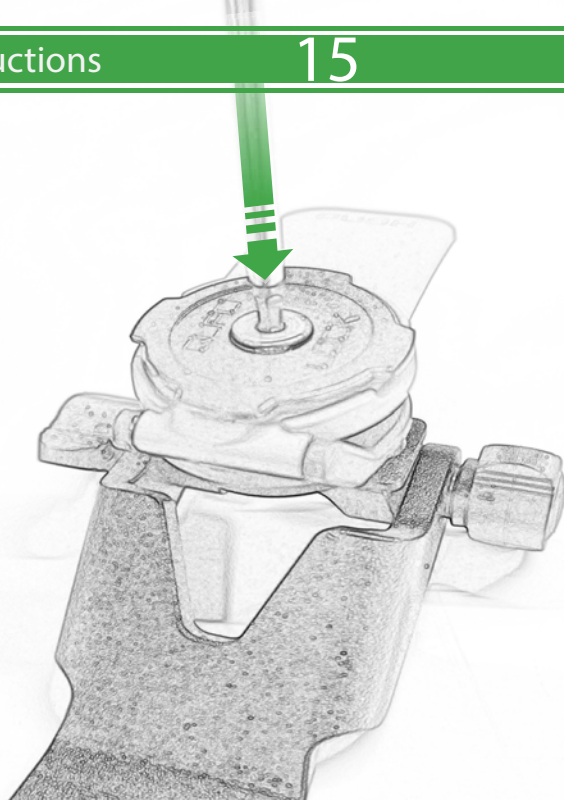

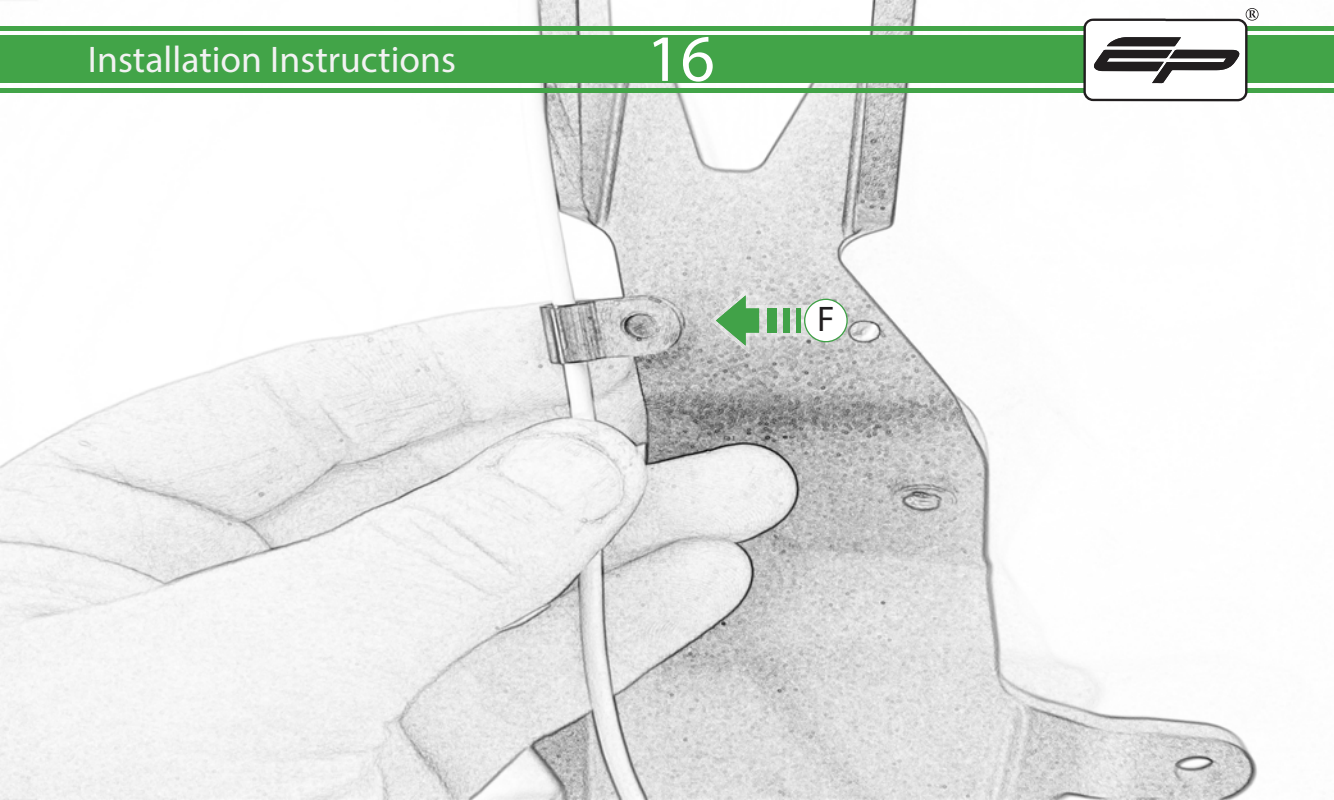

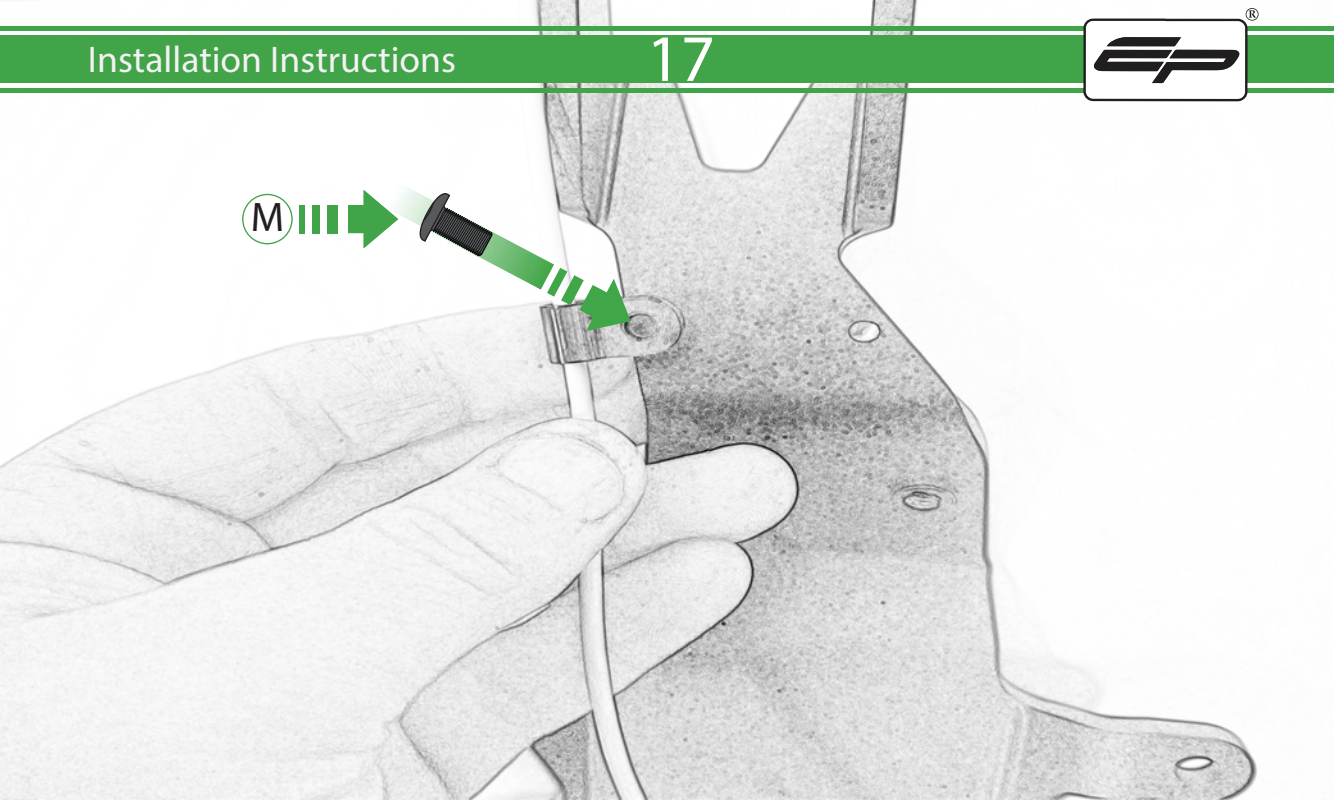

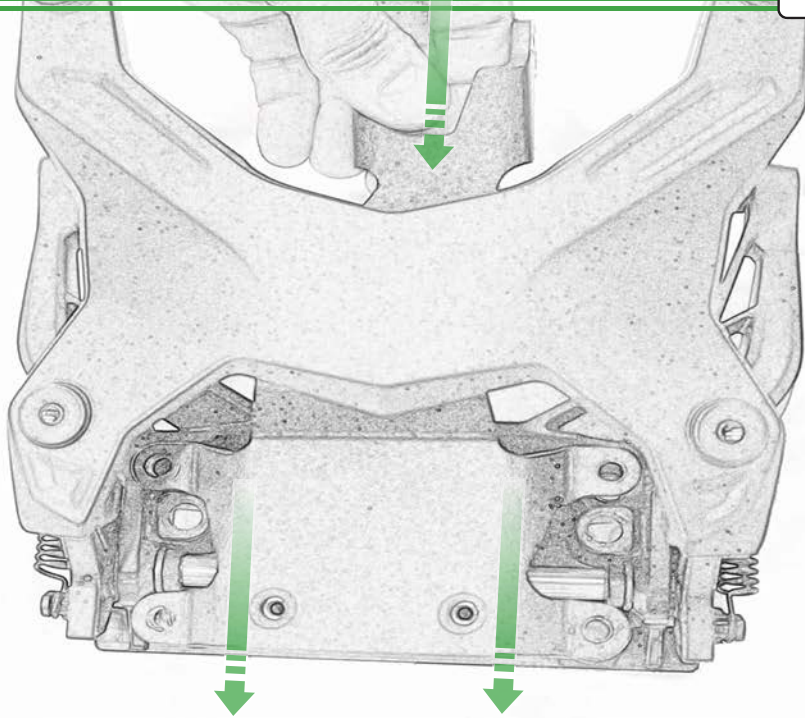

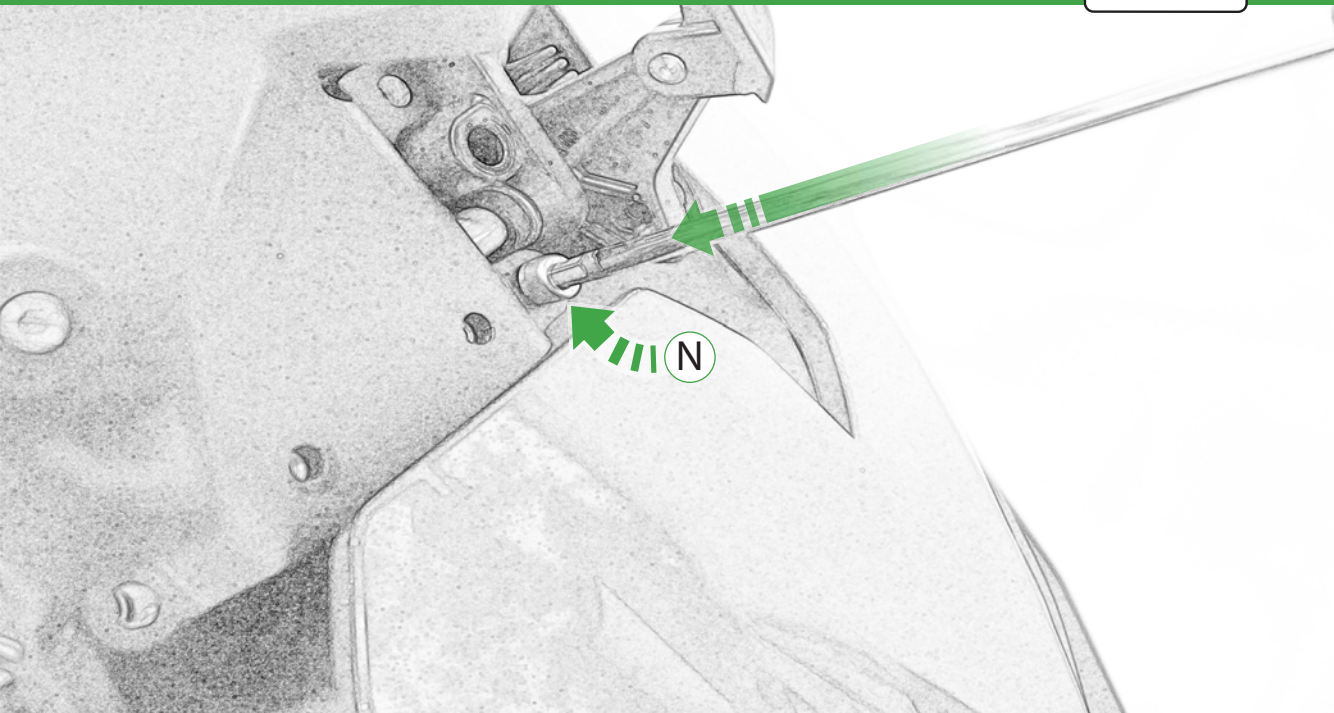

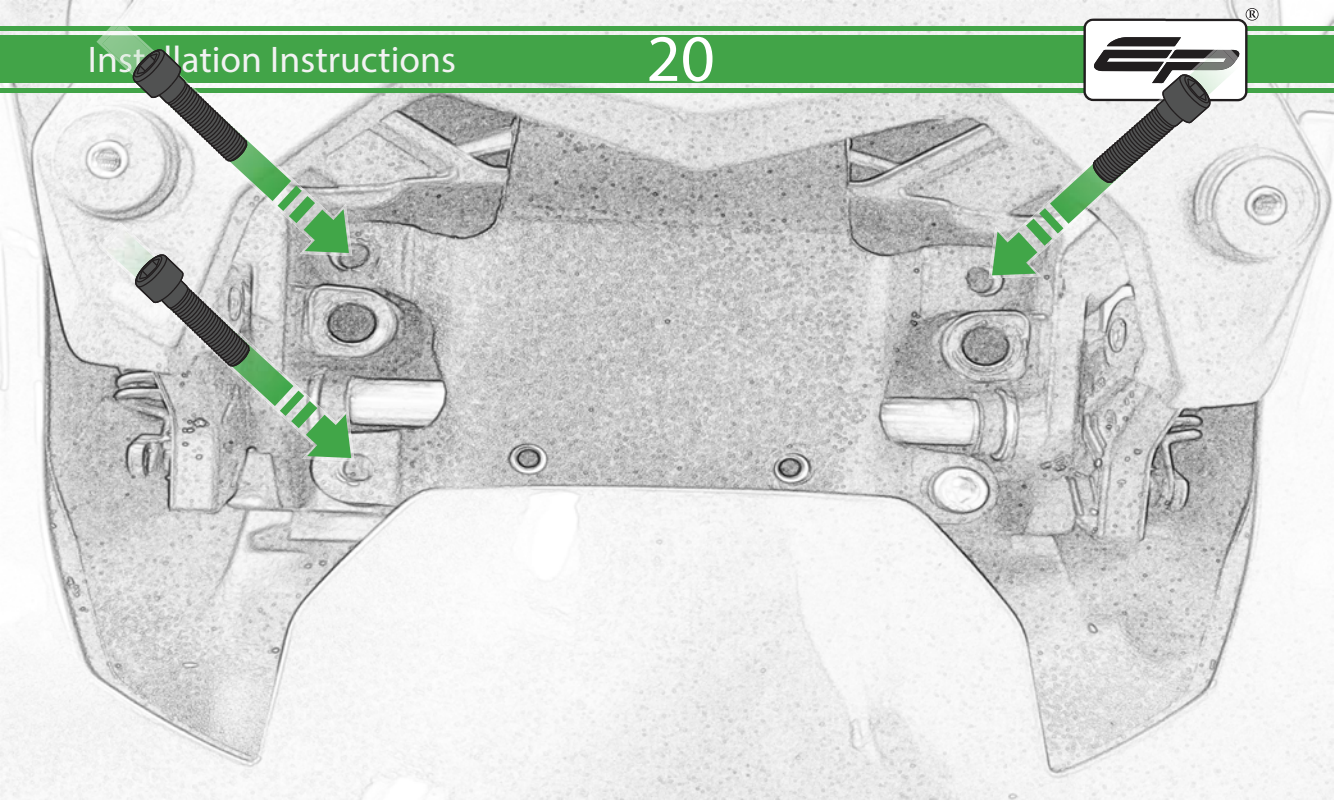

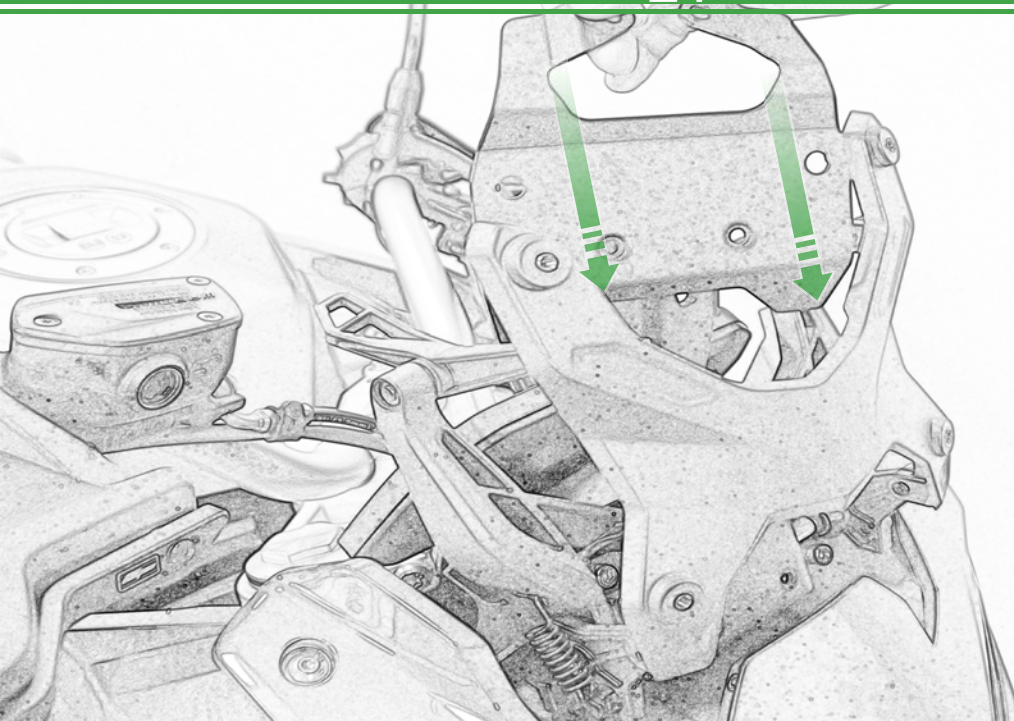

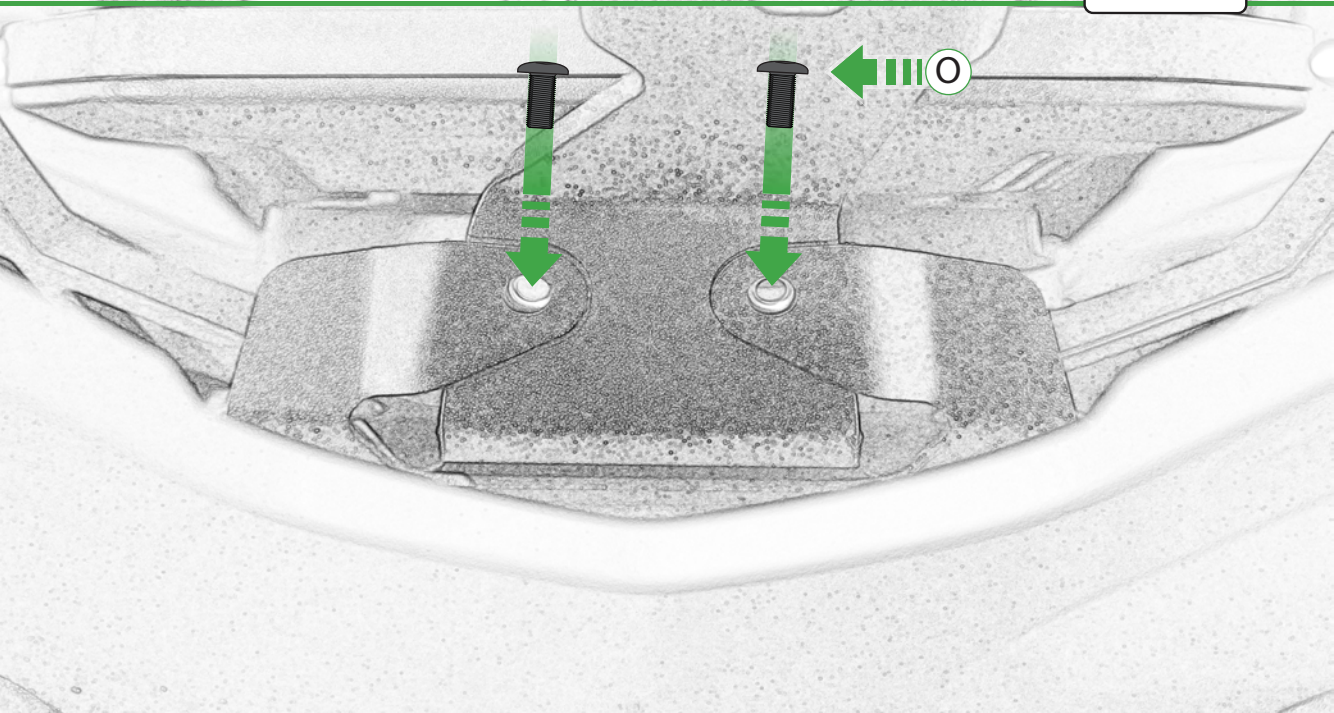



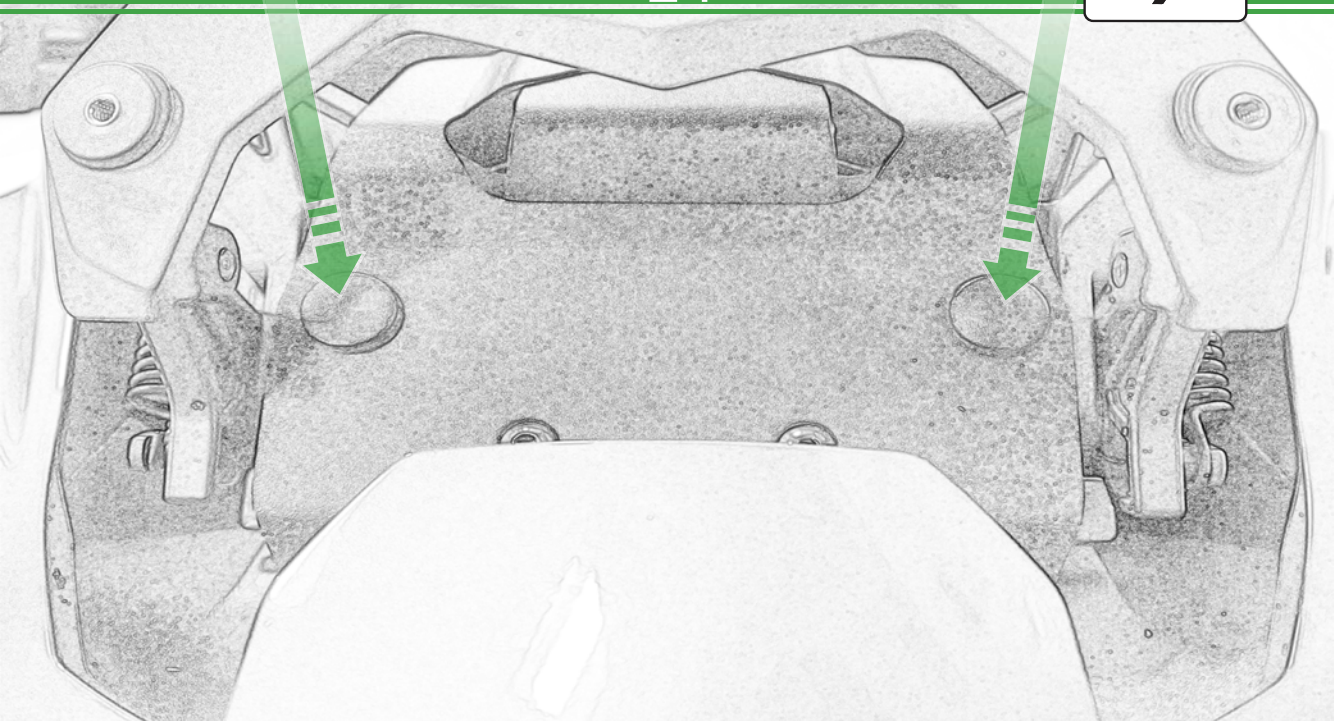

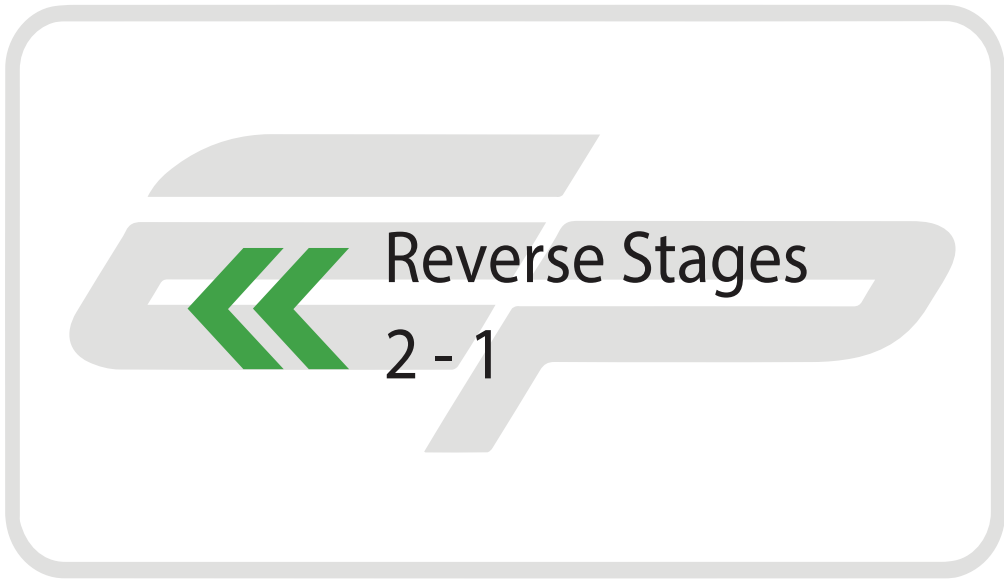



ESSENTIAL CHECKS

It is recommended that periodic inspections are made to ensure that all bolts are tightened to the specified torque settings.

Should the bike be involved in an accident a thorough inspection should be made and any components that have taken an impact, no matter how small, be replaced



EVOTECH®
P E R F O R M A N C E

www.evotech-performance.com