

**THIS SHEET INCLUDES FITTING INSTRUCTIONS FOR THE FOLLOWING PARTS:**

Secondary Alternator Cover Part No. EC-R1-2015-1-GBR / Secondary Clutch Cover Part No. EC-R1-2015-2-GBR /  
 Secondary Pulse Cover Part No. EC-R1-2015-3-GBR & EC-R1-2019-3-GBR (Race fairing version)  
 Bullet Frame Race Slider Set - STREET - Part No. FS-R1-2015-S / Bullet Frame Race Slider Set - RACE - Part No. FS-R1-2015-R / Yamaha 6mm  
 Paddock Stand / Bobbin Set Part No. BA12-6-GBR-SET / Lower Chain Guard Part No. CGA10-GBR / Brake Lever Guard Part No: BLG-R1-2006-GBR  
 Clutch Lever Guard Part No: CLG-R1-2006-GBR



**SECONDARY ALTERNATOR COVER – PART NO. EC-R1-2015-1-GBR**

1. Remove 4 existing bolts from the stock Alternator cover, shown as position Bolt 1, 2, 3 & 4.
2. Place the Secondary Alternator Cover over the stock cover.
3. Assemble 4 replacement bolts loosely in the correct position as shown.
4. Tighten bolts to a Torque of 6Nm. DO NOT OVERTIGHTEN.

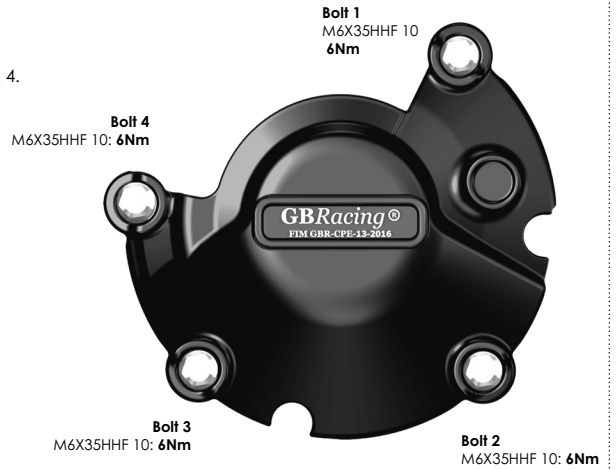
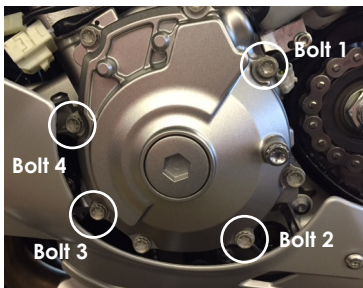

**SECONDARY CLUTCH COVER – PART NO. EC-R1-2015-2-GBR**

1. Remove 4 existing bolts from the stock Clutch cover, shown as position Bolt 1, 2, 3 & 4.
2. Place the Secondary Clutch Cover over the stock cover.
3. Assemble 4 replacement bolts loosely in the correct positions as shown.
4. Tighten bolts to a Torque of 6Nm. DO NOT OVERTIGHTEN.

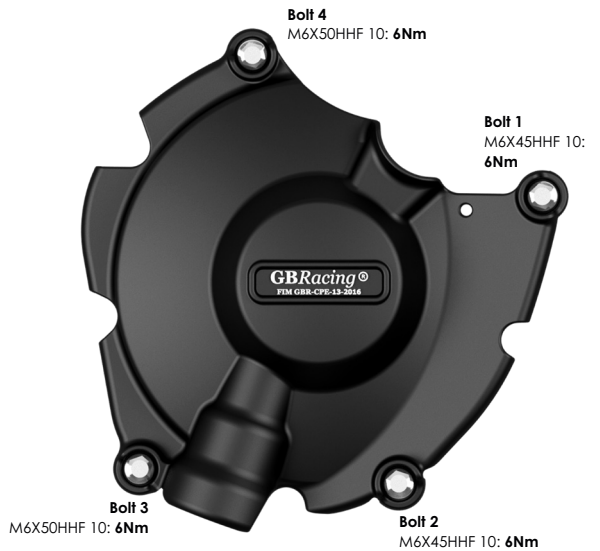
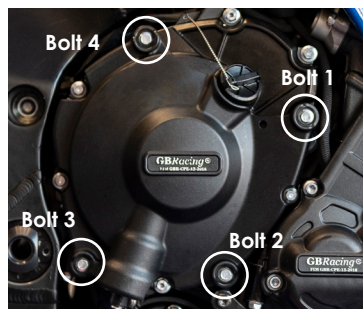
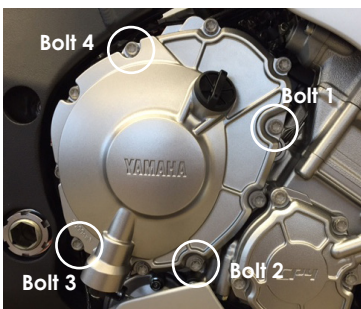

**SECONDARY PULSE COVER – PART NO. EC-R1-2015-3-GBR and EC-R1-2019-3-GBR - (RACE FAIRING VERSION)**

1. Remove 3 existing bolts from the stock pulse cover, shown as position Bolt 1, 2 & 3.
2. Place the Secondary Pulse Cover over the stock cover.
3. Assemble 3 replacement bolts loosely in the correct positions as shown.
4. Tighten bolts to a Torque of 6Nm. DO NOT OVERTIGHTEN.

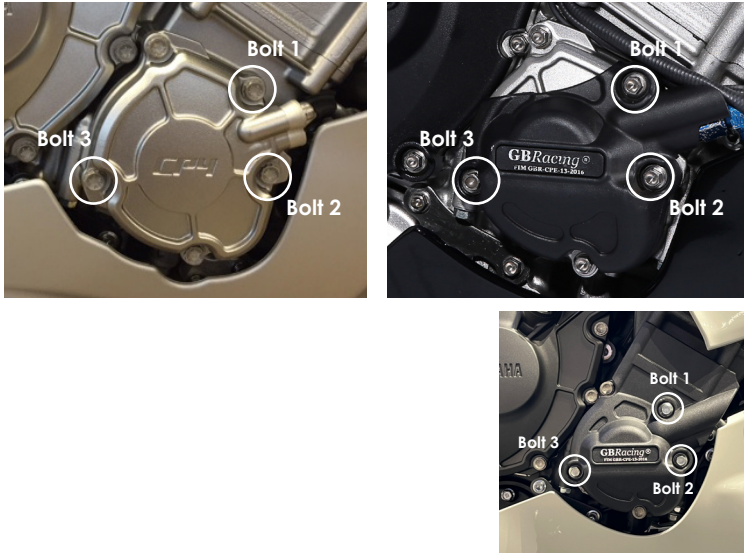

**Fig.1**

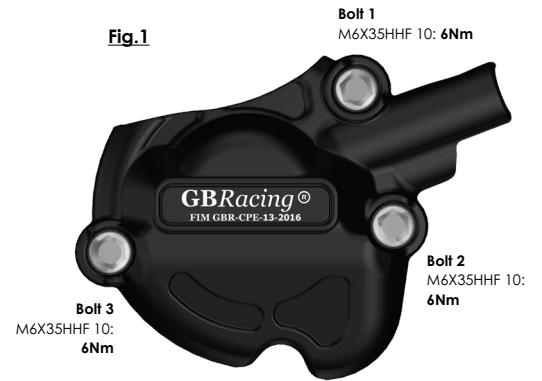

**EC-R1-2019-3-GBR (RACE FAIRING VERSION)**

This cover will not fit a road fairing

Bolt info same as **Fig.1**



**BULLET FRAME SLIDER - LEFT HAND SIDE - STREET - PART NO. FS-R1-2015-LHS-S**

1. Remove upper engine mounting bolt, located through the fairing opening. *(ensuring that the conical OE Washer is not removed).*
2. Assemble bolt through the aluminium bush into correct position.
3. Tighten to 70NM torque.
4. Slide bullet moulding onto aluminium bush.
5. Screw M6 bolt into front of bullet moulding hand tight.



**BULLET FRAME SLIDER - RIGHT HAND SIDE - STREET - PART NO. FS-R1-2015-RHS-S**

1. Remove upper engine mounting bolt, located through the fairing opening. *(ensuring that the conical OE Washer is not removed).*
2. Assemble bolt through the aluminium bush into correct position.
3. Tighten to 70NM torque.
4. Slide bullet moulding onto aluminium bush.
5. Screw M6 bolt into front of bullet moulding hand tight.



**BULLET FRAME SLIDER - LEFT HAND SIDE - RACE - PART NO. FS-R1-2015-LHS-R**

1. Remove upper engine mounting bolt, located through the fairing opening. *(ensuring that the conical OE Washer is not removed).*
2. Assemble bolt through the aluminium bush into correct position.
3. Tighten to 70NM torque.
4. Slide bullet moulding onto aluminium bush.
5. Screw M6 bolt into front of bullet moulding hand tight.

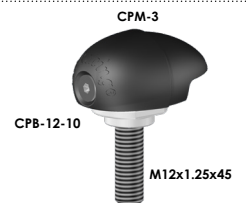

**BULLET FRAME SLIDER - RIGHT HAND SIDE - RACE - PART NO. FS-R1-2015-RHS-R**

1. Remove upper engine mounting bolt, located through the fairing opening. *(ensuring that the conical OE Washer is not removed).*
2. Assemble bolt through the aluminium bush into correct position.
3. Tighten to 70NM torque.
4. Slide bullet moulding onto aluminium bush.
5. Screw M6 bolt into front of bullet moulding hand tight.



**PADDOCK STAND / BOBBIN SET - PART NO. BA12-6-GBR-SET**

- 1 Assemble M6 x 40mm Bolt & M6 Washer through the moulded bobbin.
- 2 Tighten bolts to swing arm boss, 8 Nm.  
DO NOT OVERTIGHTEN



**LOWER CHAIN GUARD – PART NO. CGA10-GBR**

- 1 Assemble 2 bolts and washers through the lower chain guard into the Black Anodised aluminium mounting block CGA10-2.
- 2 Position the assembly underneath the swing arm, closing the gap to the rear sprocket.  
Note : There should be a 5mm minimum gap from the bike chain to the lower chain guard.
- 3 Mark off the chosen hole positions.
- 4 Drill & Tap the marked holes , M6 - (Drill 5mm Dia. for tapping)
- 5 Disassemble the Black Anodised block from the assembly, and mount the block to the underside of the swing arm using the remaining 2 bolts and washers.
- 6 Re-assemble the lower chain guard to the fixed bracket.



**YAMAHA R1 BRAKE LEVER GUARD – PART NO. BLG-R1-2006-GBR**

STOCK ONLY

FITS MODELS 2006-2023

*Please note: Must use Thread Lock (not supplied) for correct operation.*

- 1 Remove existing bar end assembly.
  - 2 Assemble bolt through lever guard into spacer (shown in Fig.1) and then insert into handlebar end and tighten M6 Bolt to **15Nm - DO NOT OVERTIGHTEN.**
- Note: Please be aware that there will still be apparent movement in the lever protector due to the fact it is rubber mounted.  
Do not ride if you are unsure if it is tight enough and always get a trained technician to confirm.

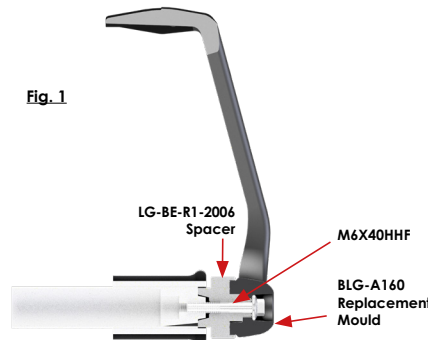

**YAMAHA R1 CLUTCH LEVER GUARD – PART NO. CLG-R1-2006-GBR**

STOCK ONLY

FITS MODELS 2006-2023

*Please note: Must use Thread Lock (not supplied) for correct operation.*

- 1 Remove existing bar end assembly.
  - 2 Assemble bolt through lever guard into spacer (shown in Fig.1) and then insert into handlebar end and tighten M6 Bolt to **15Nm - DO NOT OVERTIGHTEN.**
- Note: Please be aware that there will still be apparent movement in the lever protector due to the fact it is rubber mounted.  
Do not ride if you are unsure if it is tight enough and always get a trained technician to confirm.

