



KTm 790 Duke
Tail Tidy

Installation Instructions

Kit Contents PRN014017

- (A) 1 x Reflector Kit
- (B) 1 x Loom Connector
- (C) 2 x Rubber Grommets
- (D) 2 x 4mm Dowel Pins
- (E) 2 x M5 x 16mm Capheads
- (F) 3 x Male Bullet Connectors
- (G) 4 x M5 x 16mm Capheads

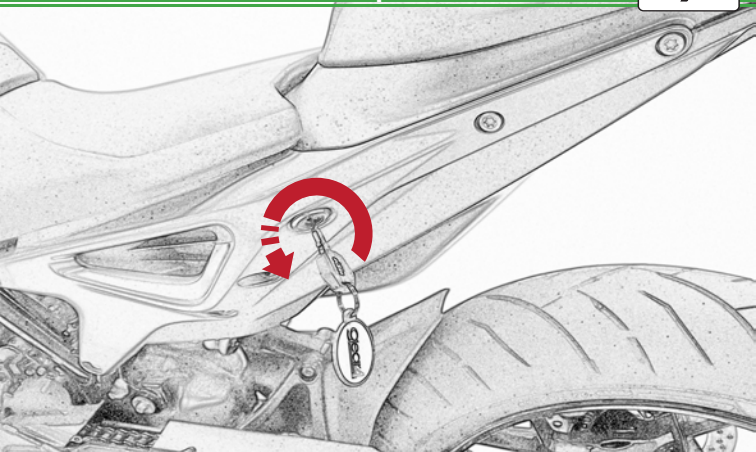

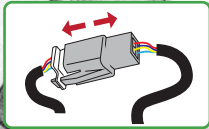
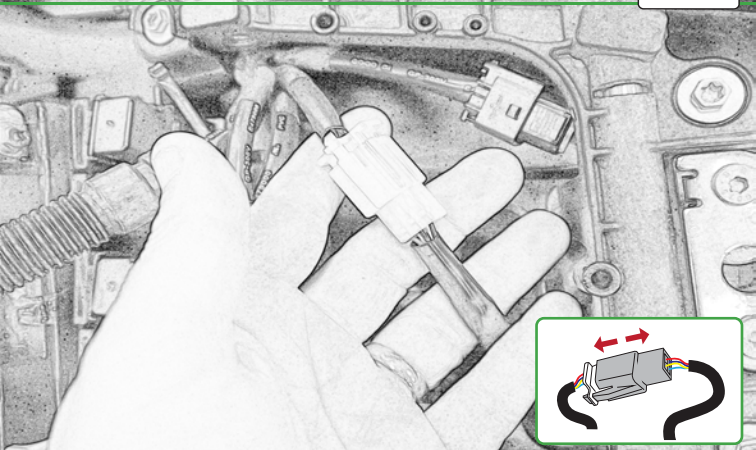



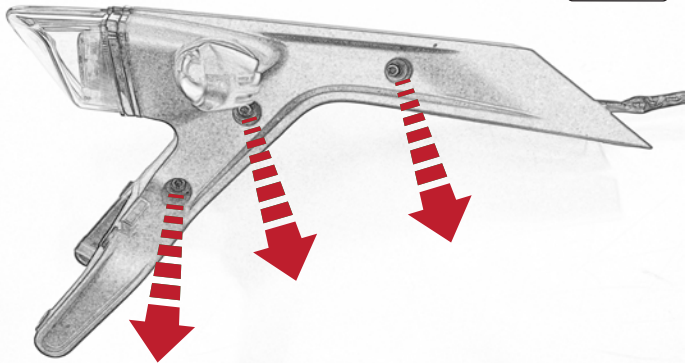

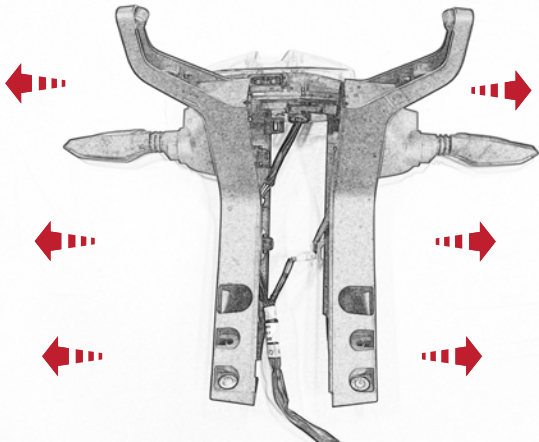

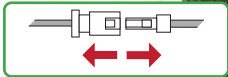
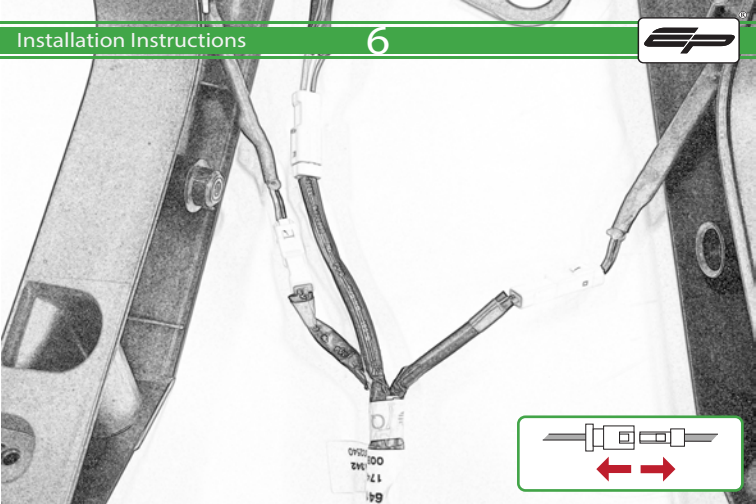

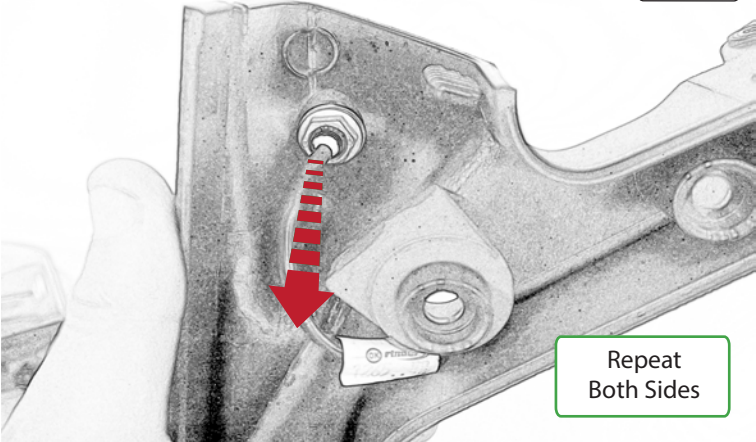

Repeat
Both Sides

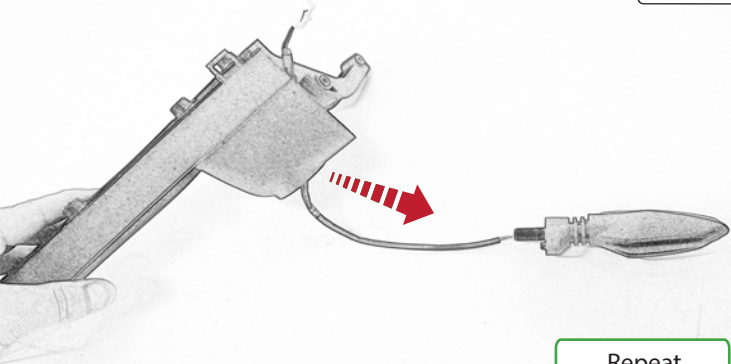

Repeat
Both Sides

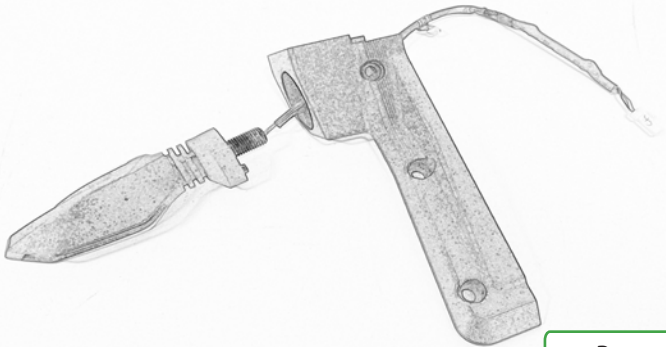

Repeat
Both Sides

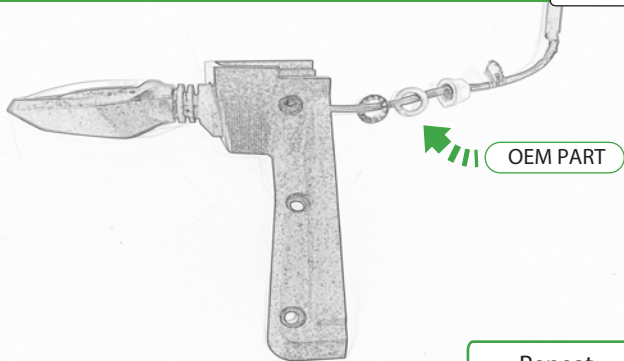

Repeat
Both Sides

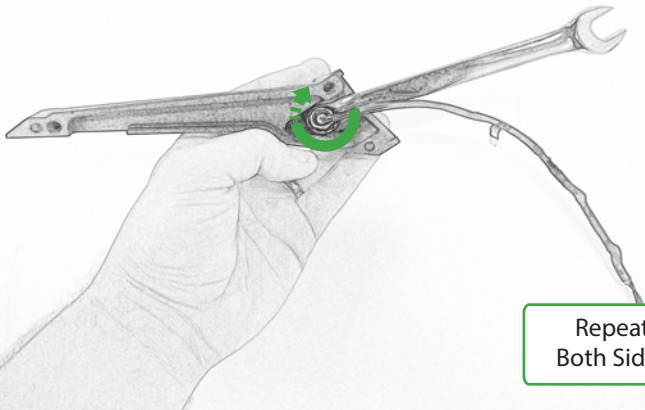

Repeat
Both Sides

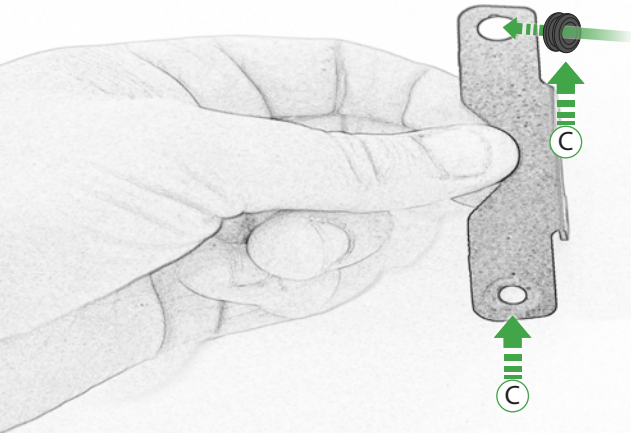

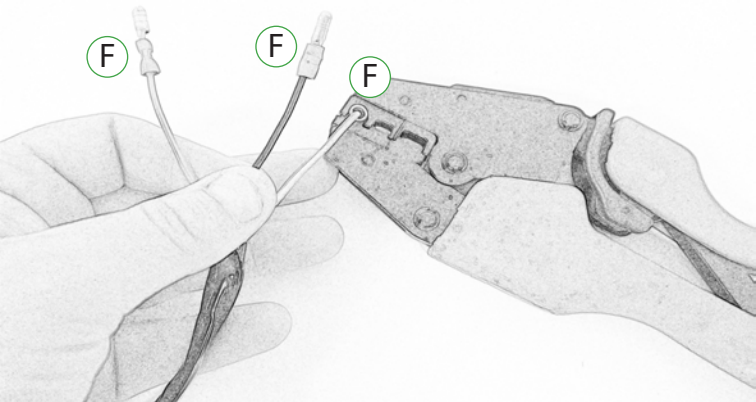

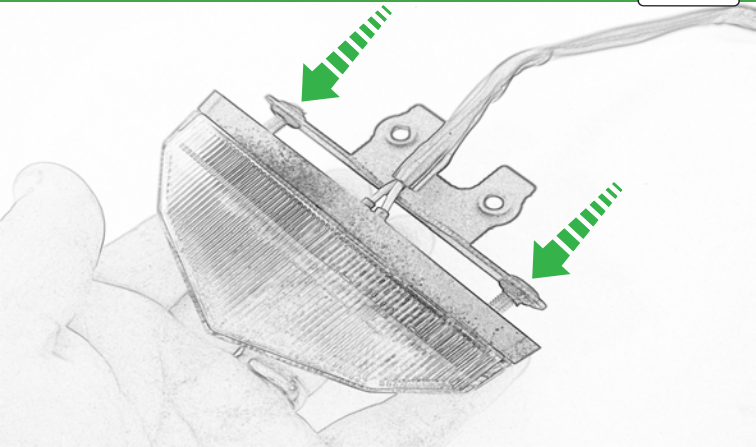

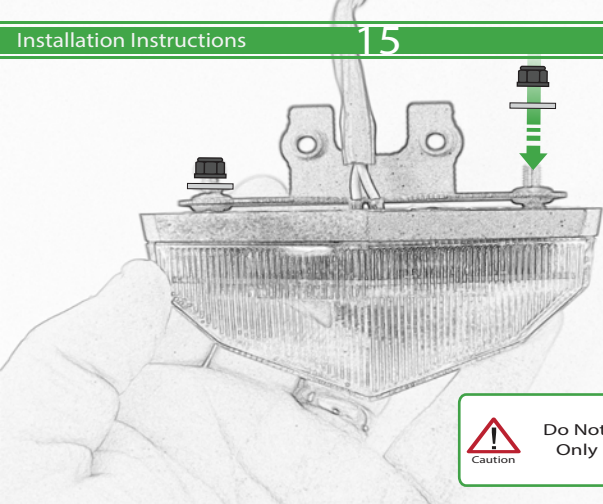

Caution

Do Not Fully Tighten
Only Rotate 6 Full
Turns

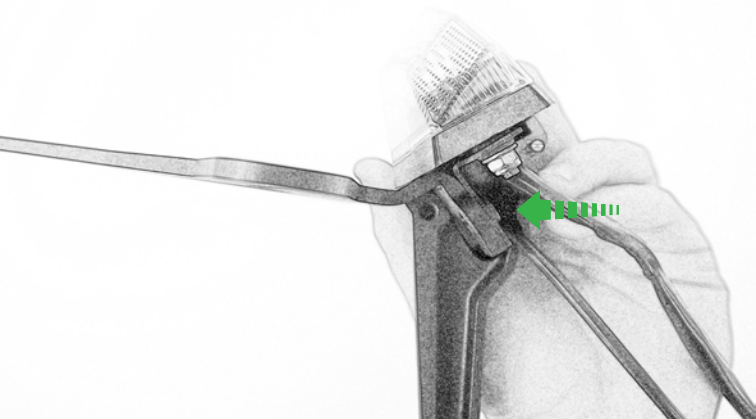

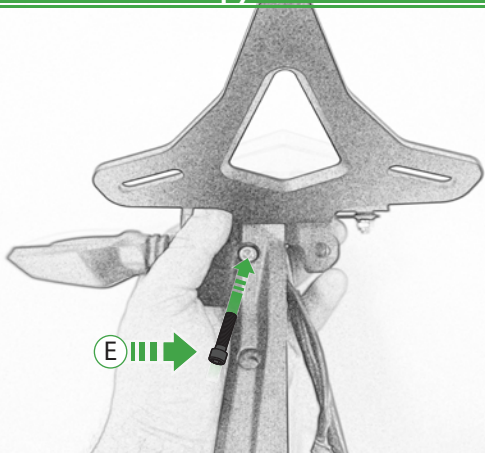

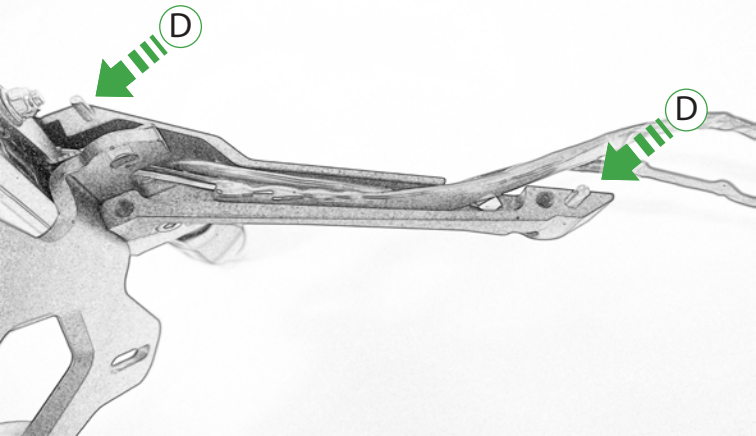

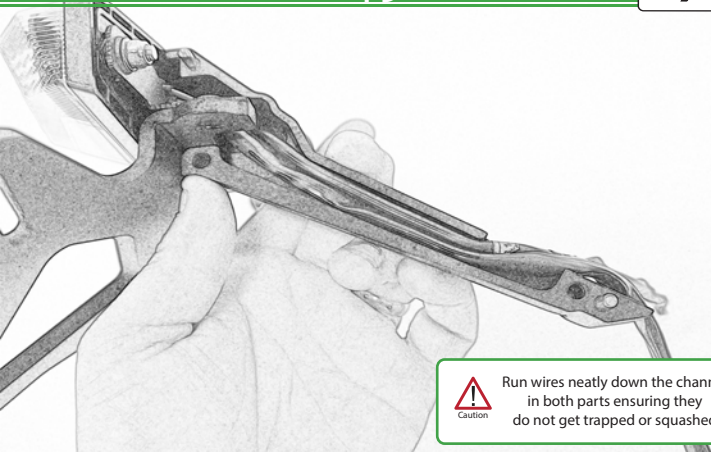

Run wires neatly down the channel in both parts ensuring they do not get trapped or squashed

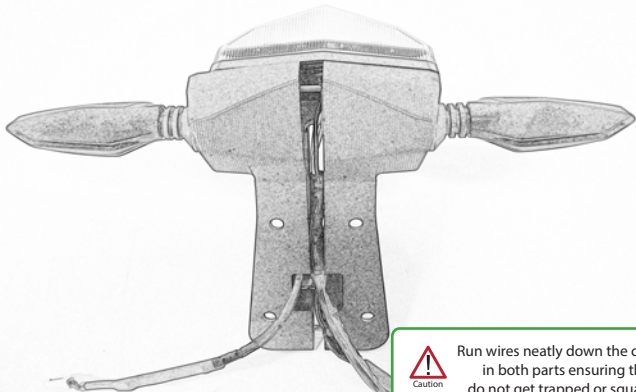

Run wires neatly down the channel in both parts ensuring they do not get trapped or squashed

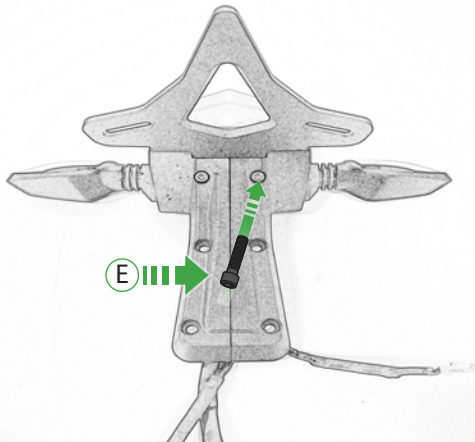

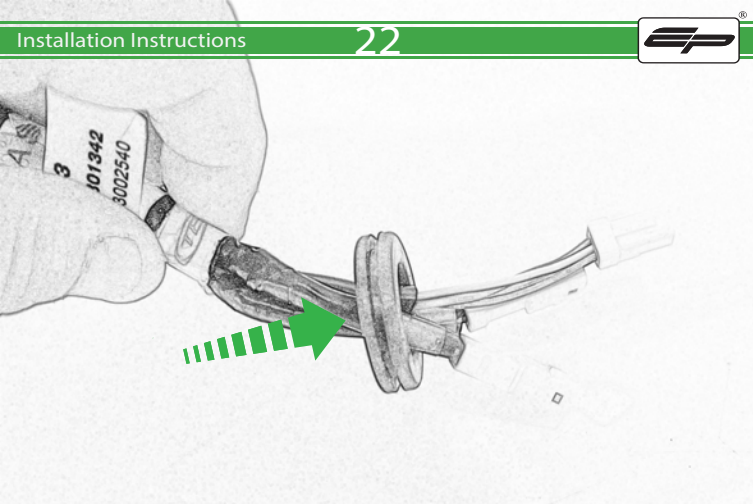

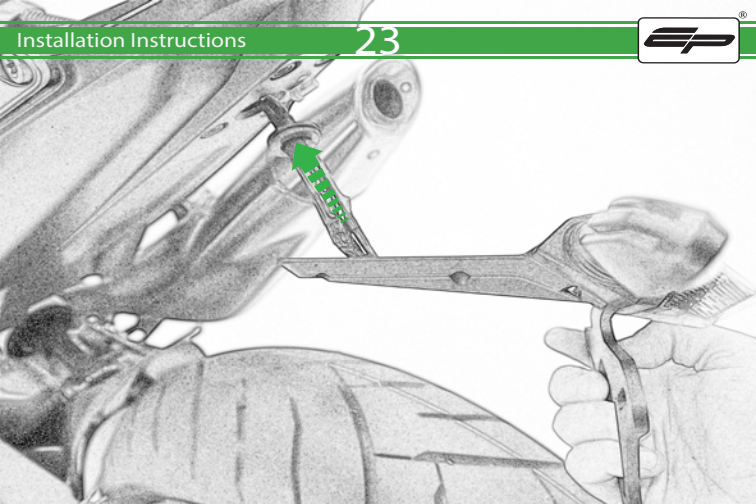

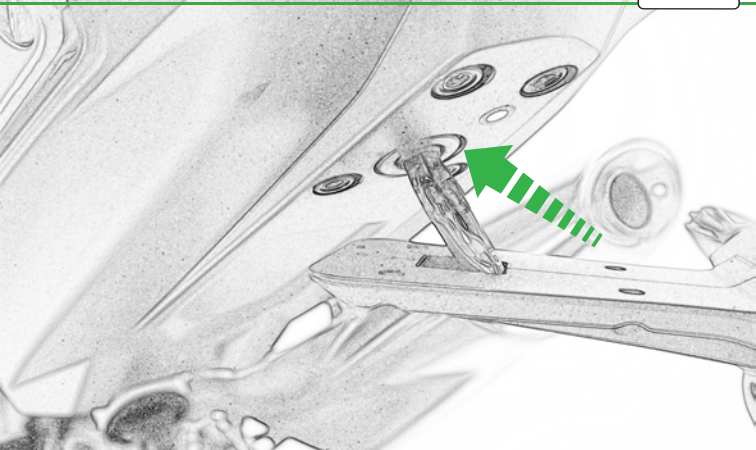

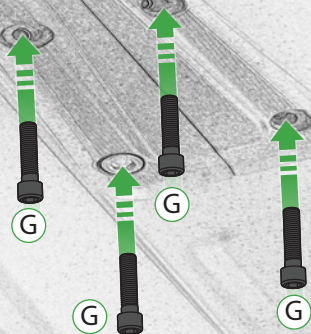

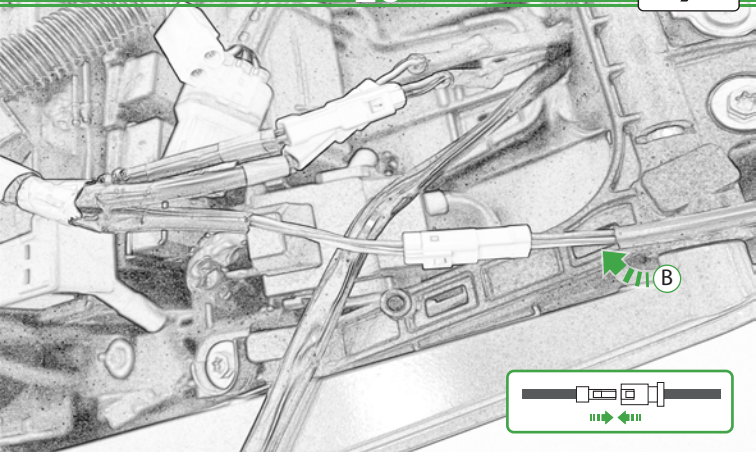

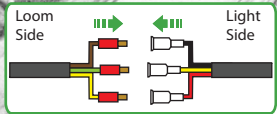
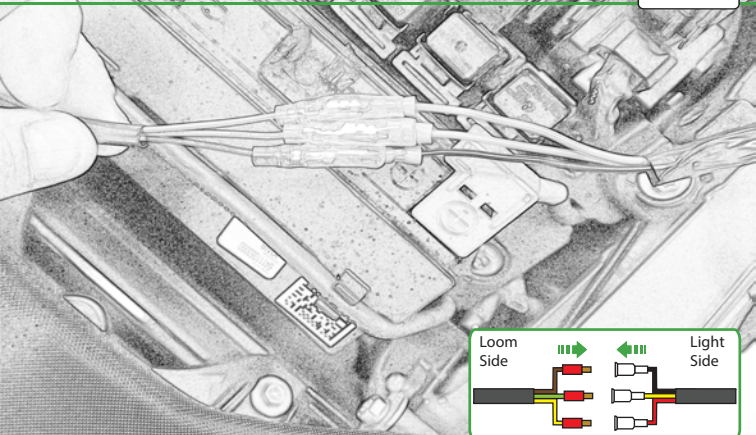



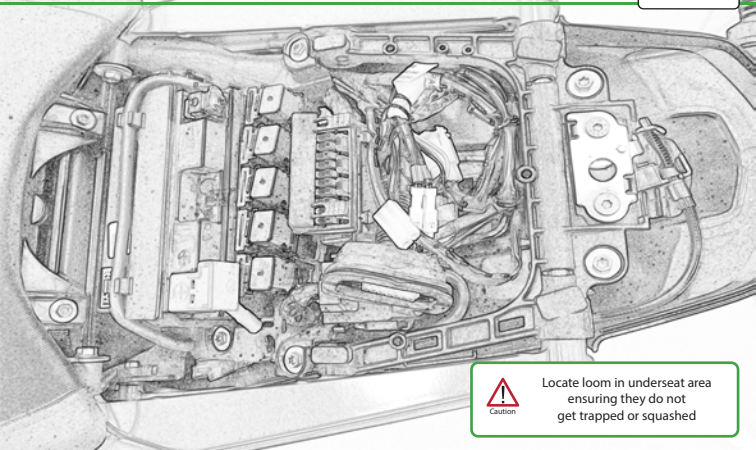

Locate loom in underseat area
ensuring they do not
get trapped or squashed



 **ESSENTIAL CHECKS** 

After installation of your tail tidy ensure that the licence plate does not contact the rear tyre when suspension is fully compressed.

Ensure all electrics including indicators, tail light, brake light and licence plate light lights are working correctly before riding the motorcycle.

It is recommended that periodic inspections are made to ensure that all fixings are fully tightend.

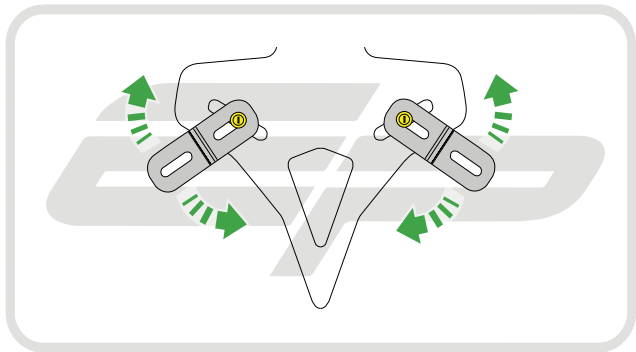

EVOTECH[®]
P E R F O R M A N C E

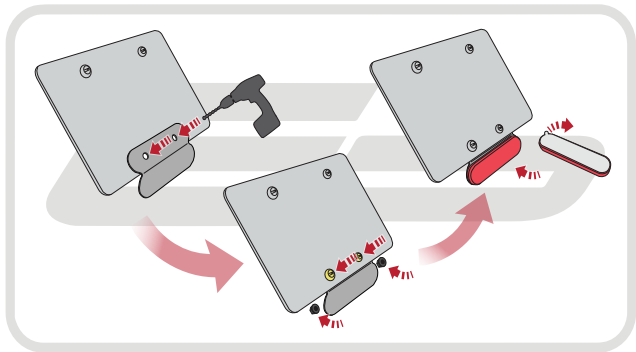



EVOTECH®
P E R F O R M A N C E

www.evotech-performance.com

