



**Ducati Panigale V4  
Radiator Guard Set**

**Installation Instructions**



## Kit Contents PRN013860

- Ⓐ 12 x Rubber Bungs

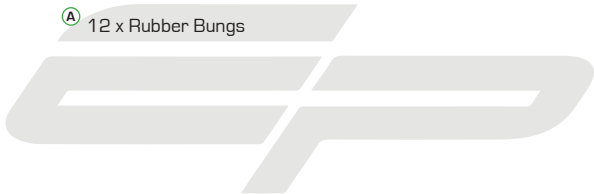

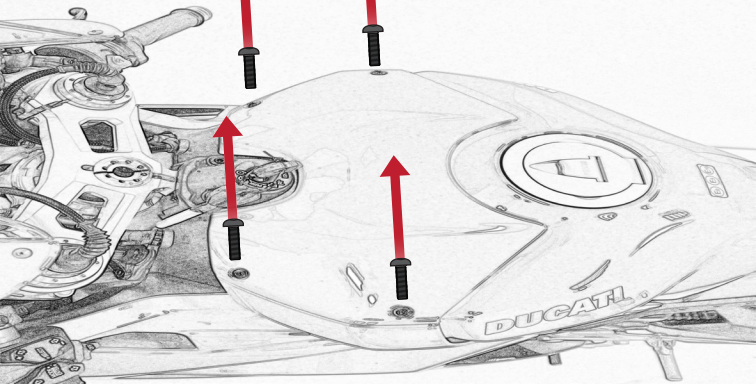

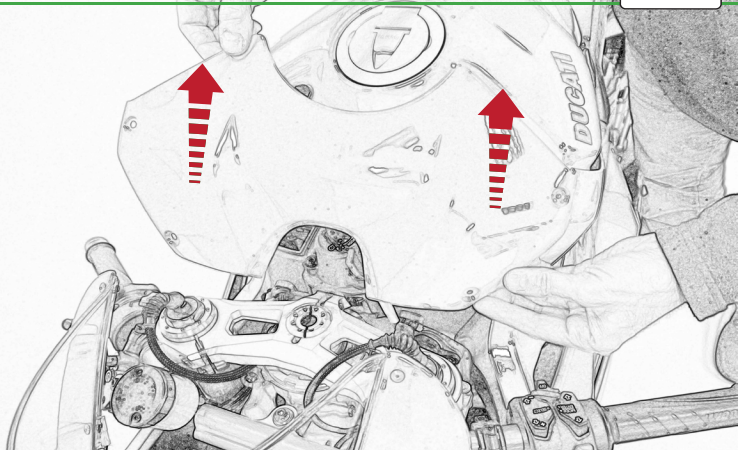



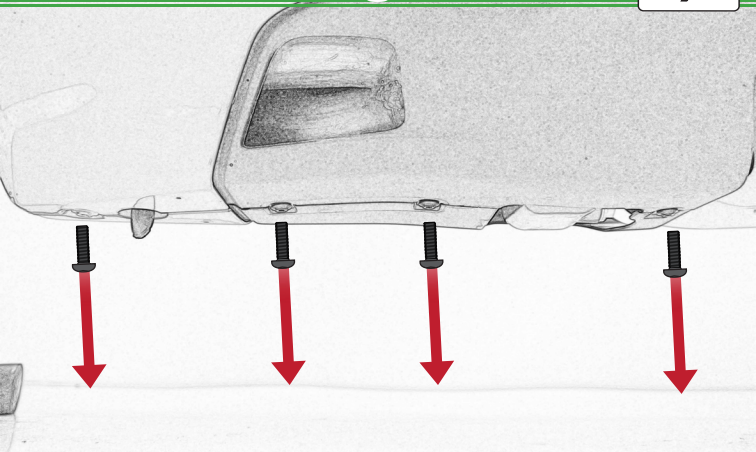

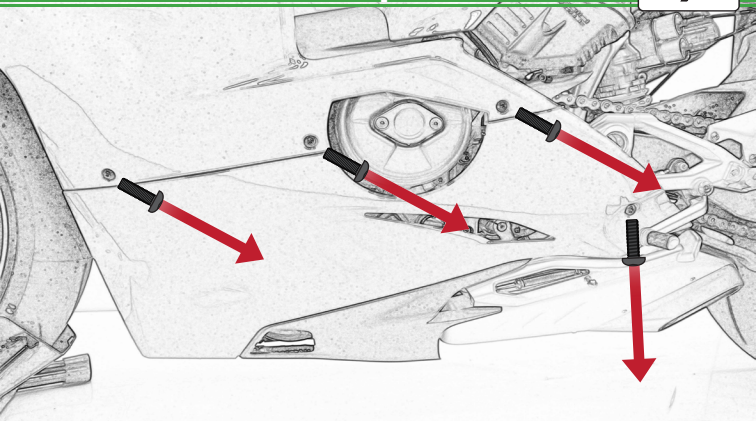

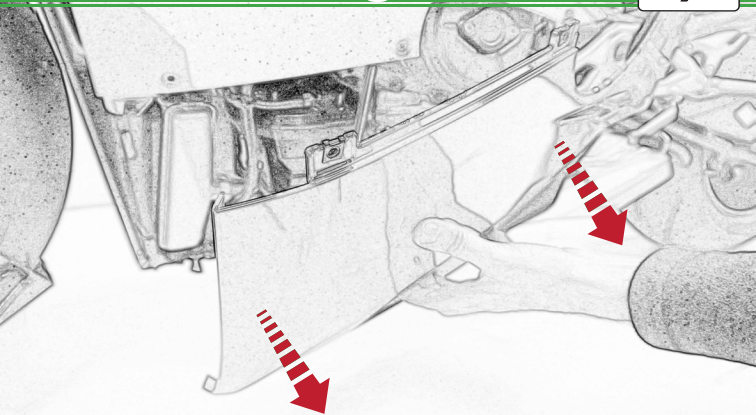

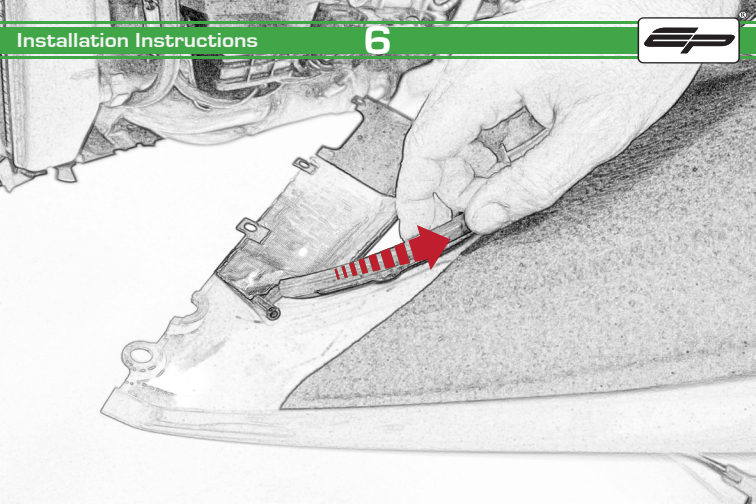

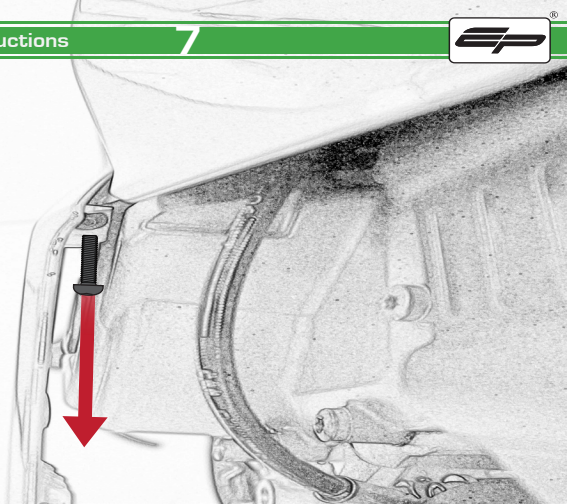

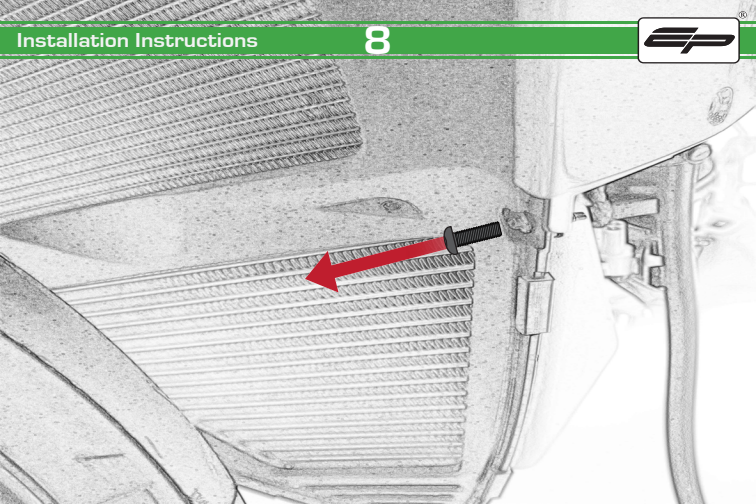

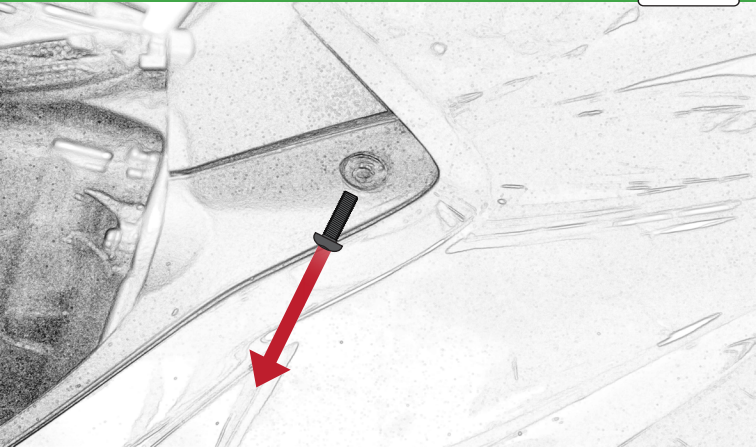

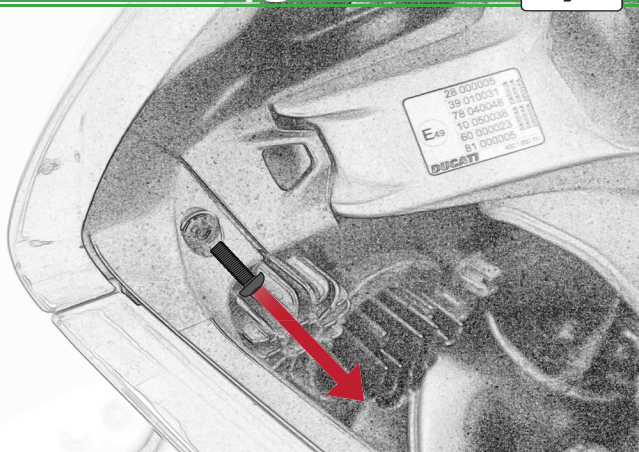



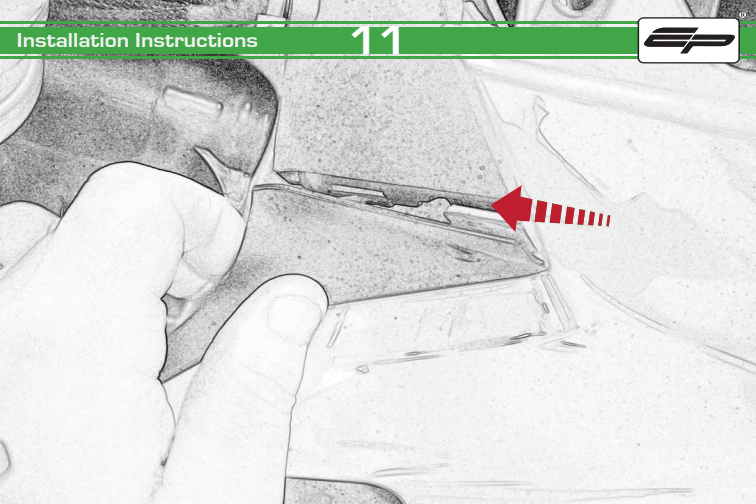

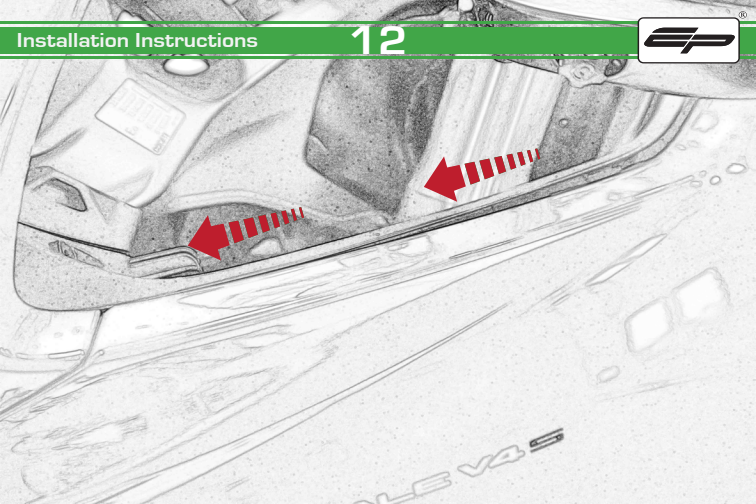

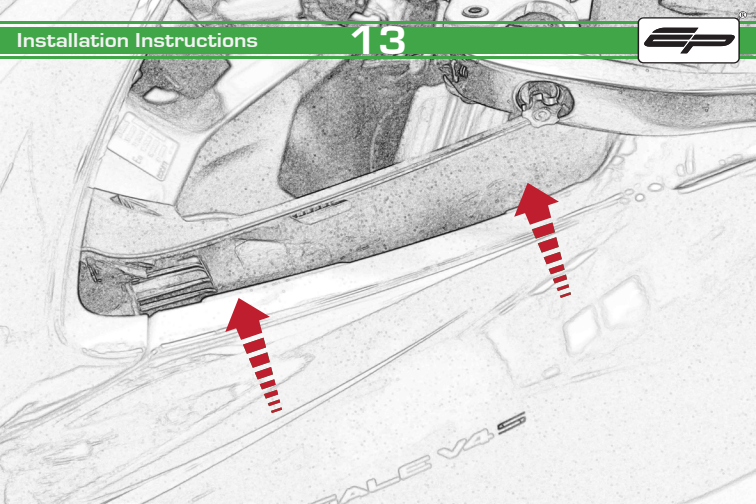

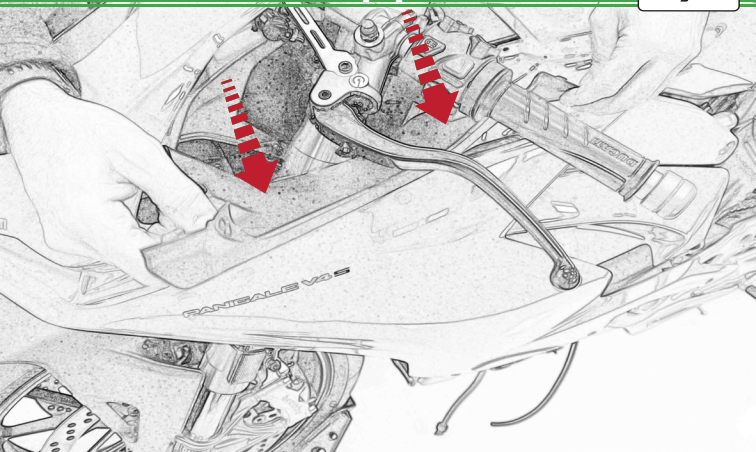

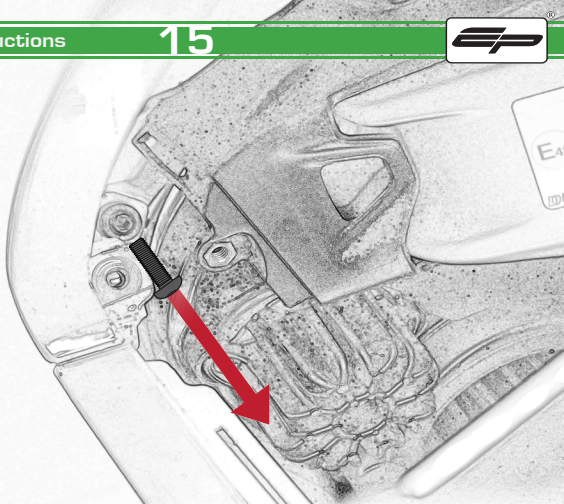

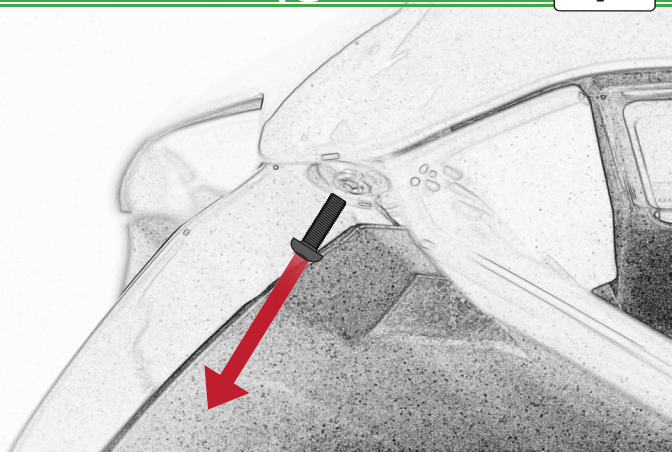

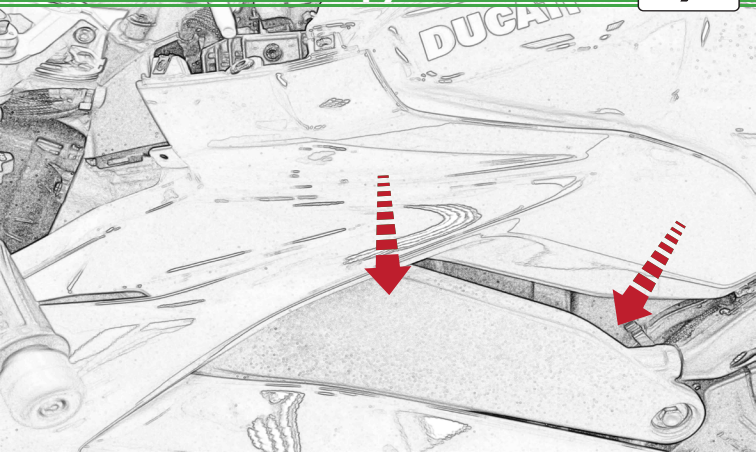

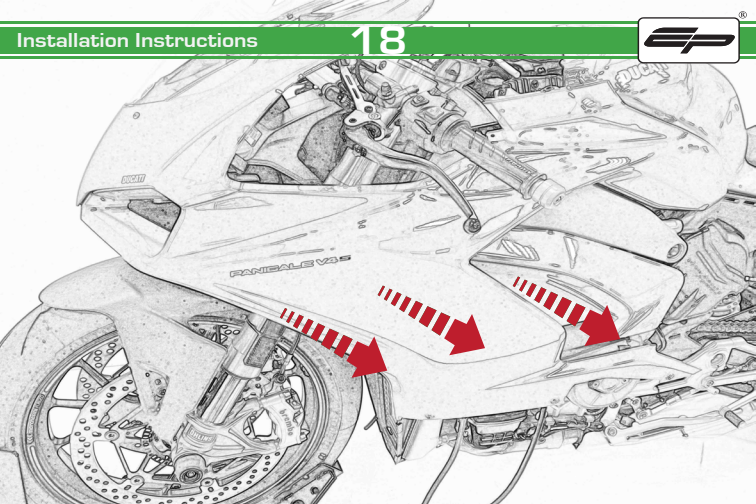



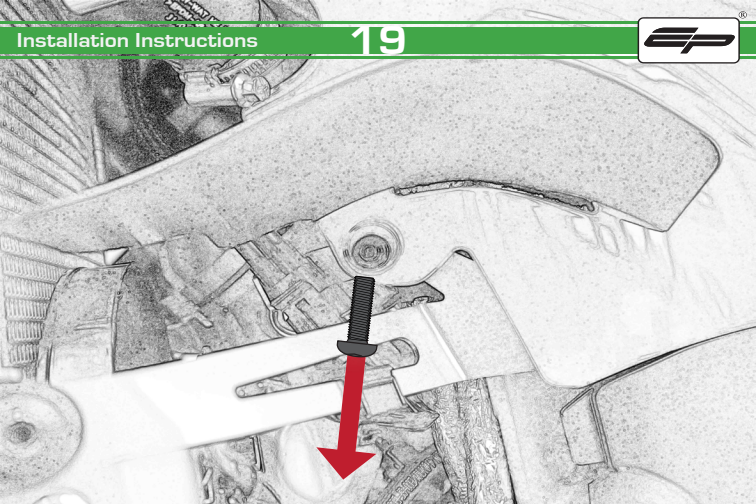

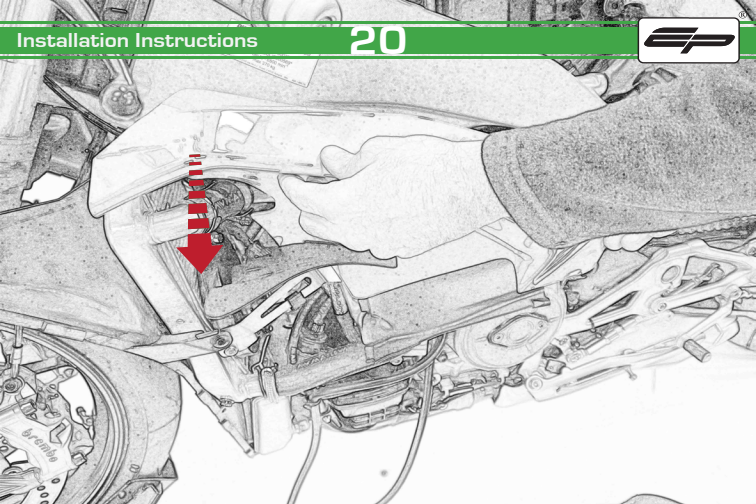

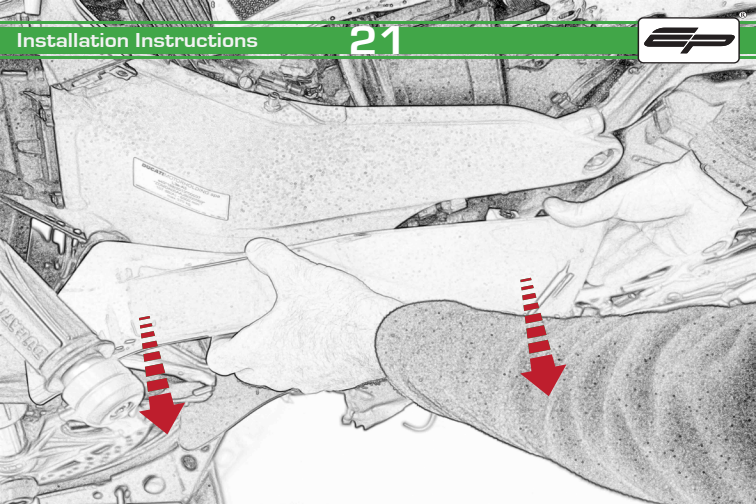

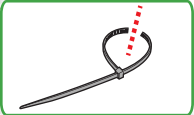
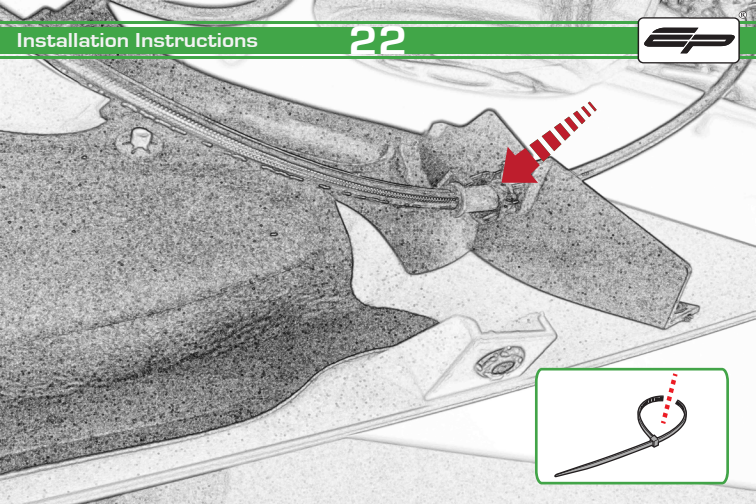

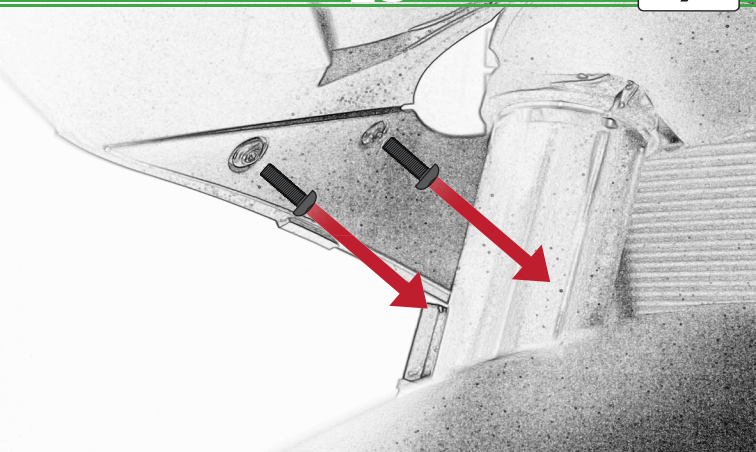

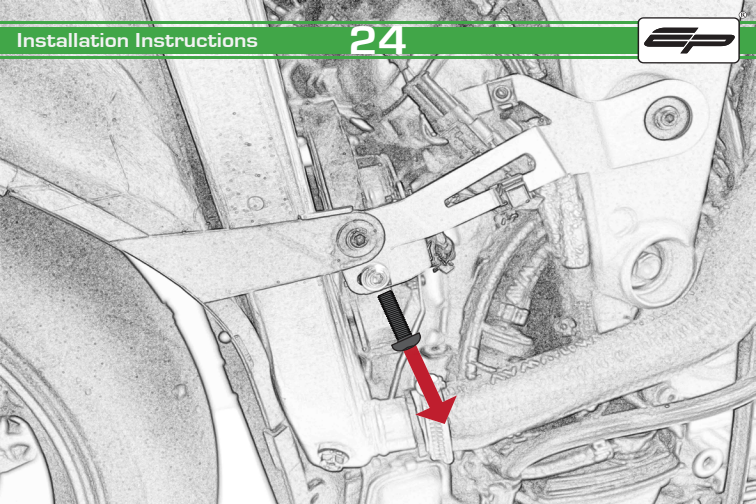

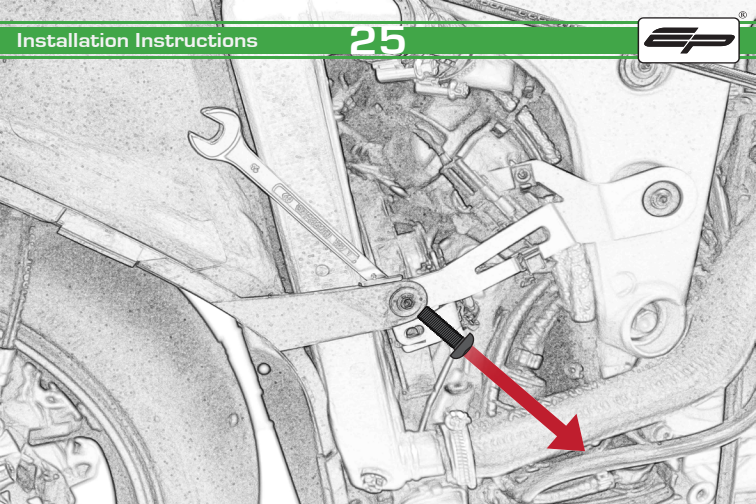

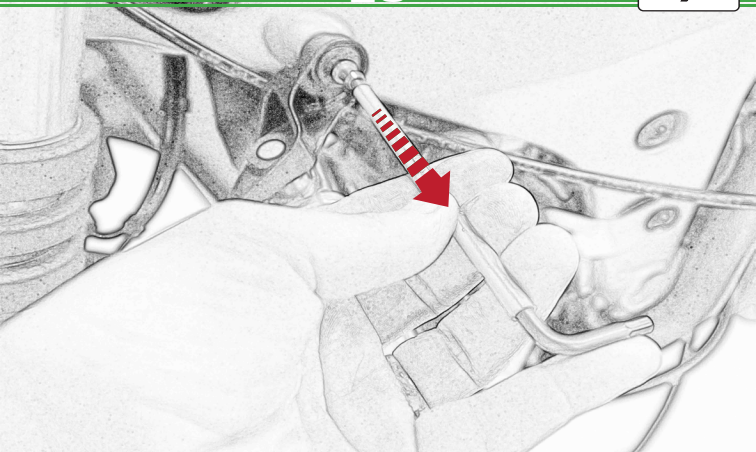



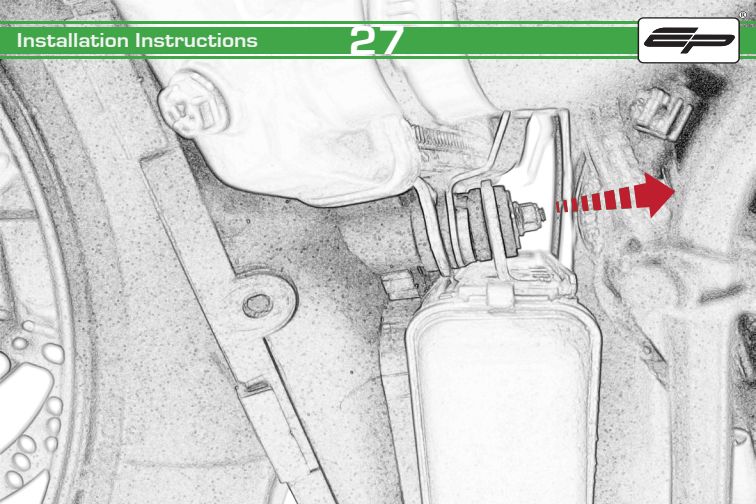

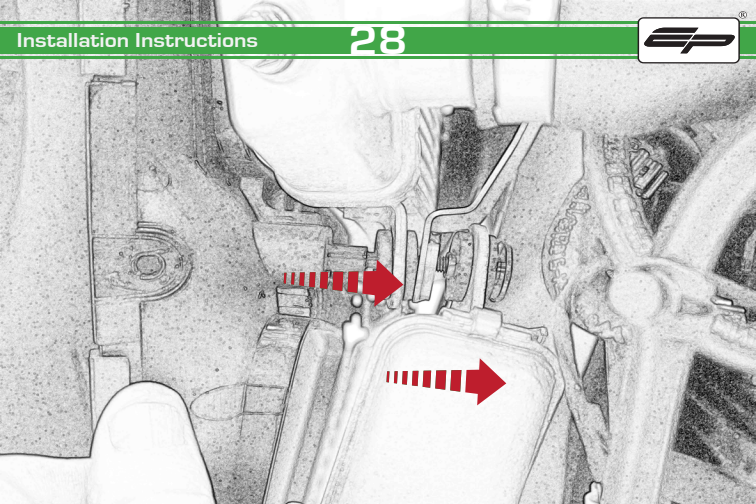

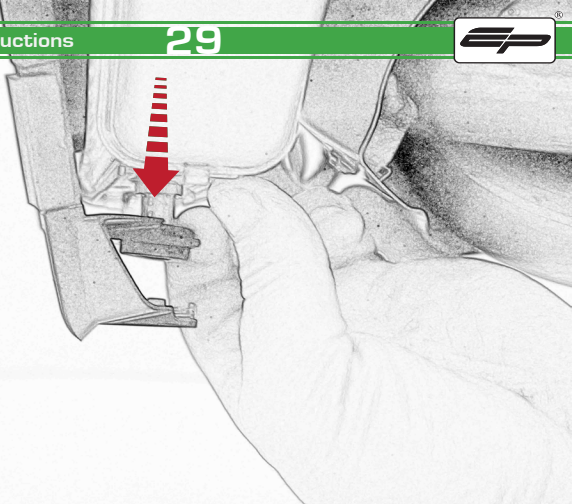

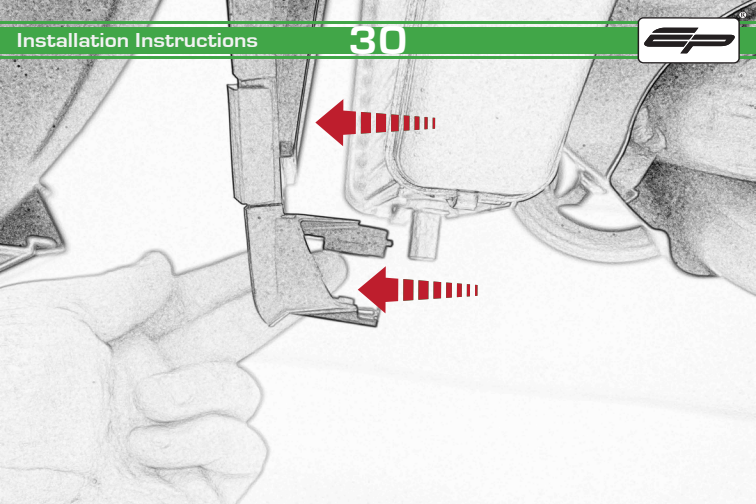

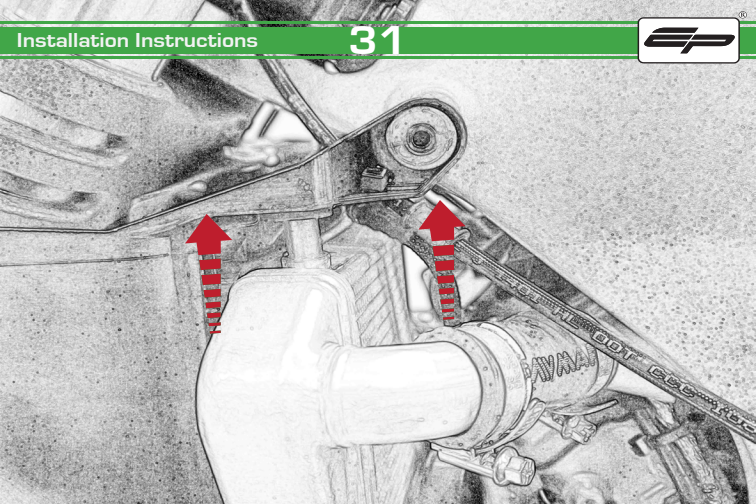

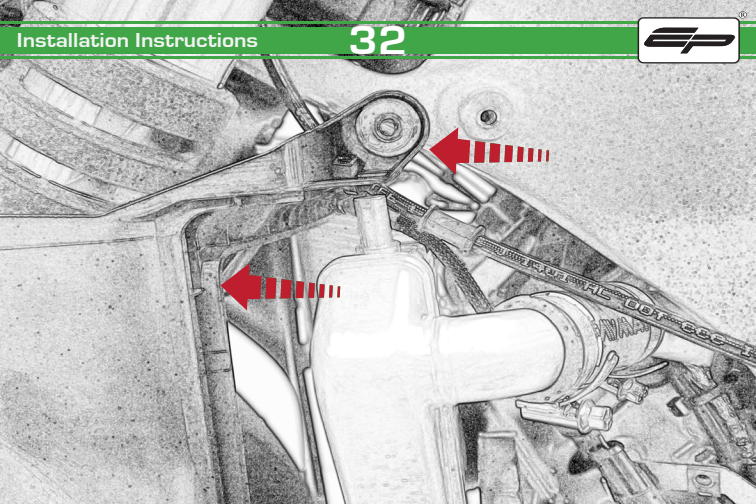

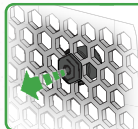
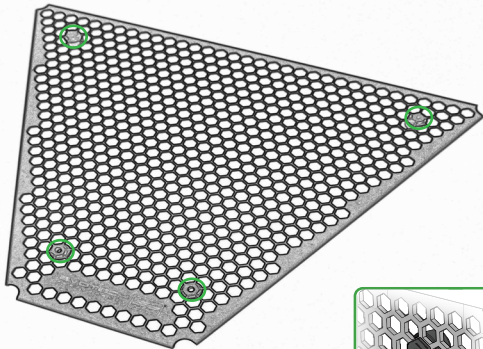

Locate round holes amongst hexagons.

Push Rubber Spacer through from the back of the guard so Hexagonal shape sits on the front face

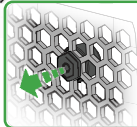
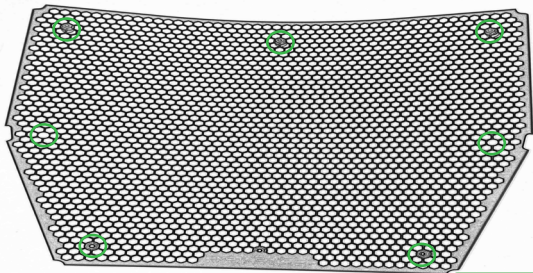

Locate round holes amongst hexagons.

Push Rubber Spacer through from the back of the guard so Hexagonal shape sits on the front face





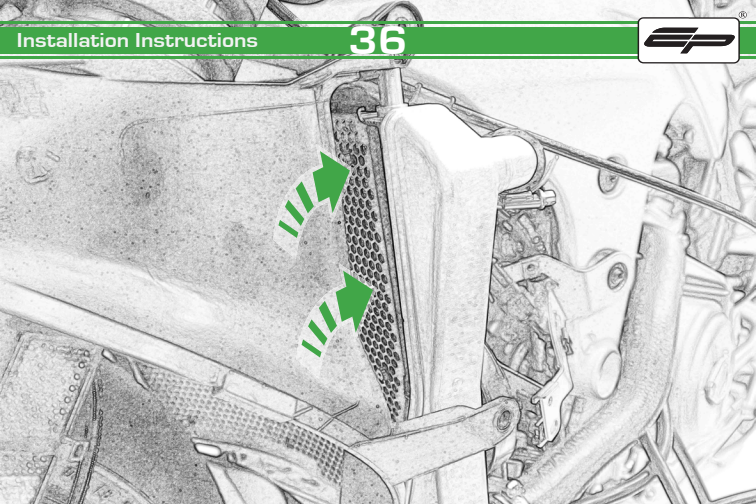

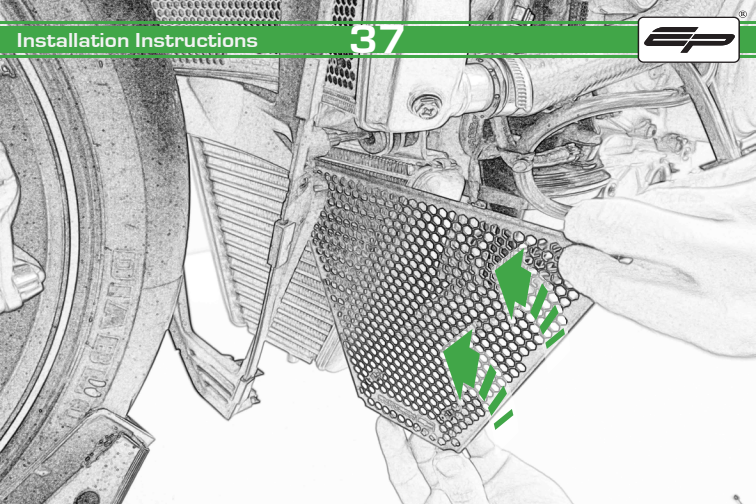

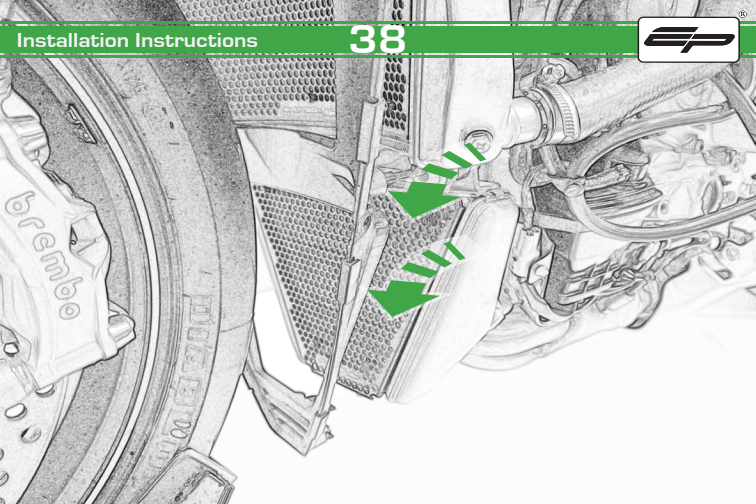

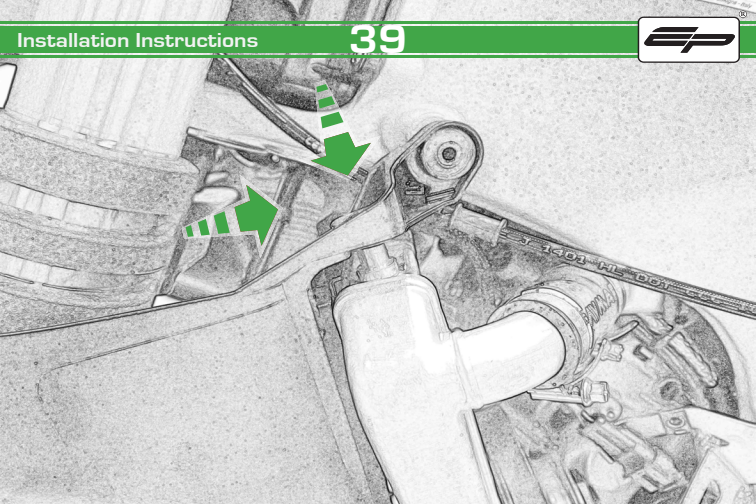

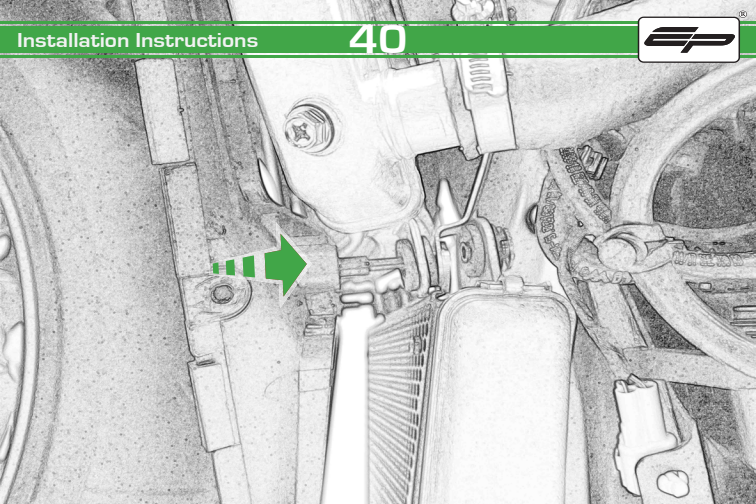



Reverse Stages

27 - 1

### **ESSENTIAL CHECKS**

It is recommended that periodic inspections are made to ensure that dirt and debris have not become trapped between the guard and the radiator/oil cooler. Such dirt and debris would reduce the cooling efficiency of the radiator/oil cooler.

It is recommended that periodic inspections are made to ensure that all fixings are fully tightened.





**EVOTECH**®  
P E R F O R M A N C E

[www.evotech-performance.com](http://www.evotech-performance.com)