

**EVOTECH**®  
P E R F O R M A N C E

[www.evotech-performance.com](http://www.evotech-performance.com)

Suzuki GSX-S 1000 GT

Tail Tidy



## Kit Contents

- Ⓐ 1 x Retro Light
- Ⓑ 1 x Connector 10
- Ⓒ 2 x M4 Flange Nut
- Ⓓ 2 x No 2 P-clip
- Ⓔ 2 x M4 x 5mm Black Button Bolts
- Ⓕ 2 x M5 x 12mm Black Button Bolts
- Ⓖ 4 x M6 x 16mm Black Button Bolts

P E R F O R M A N C E

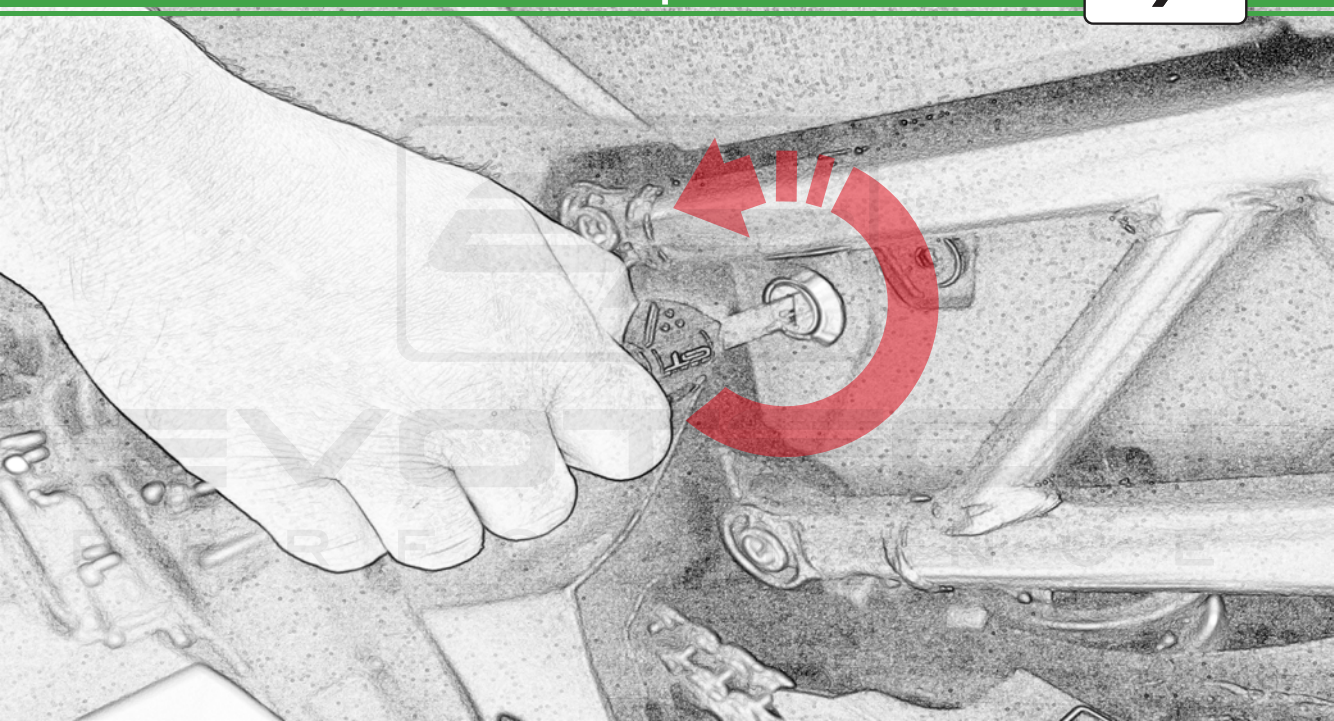

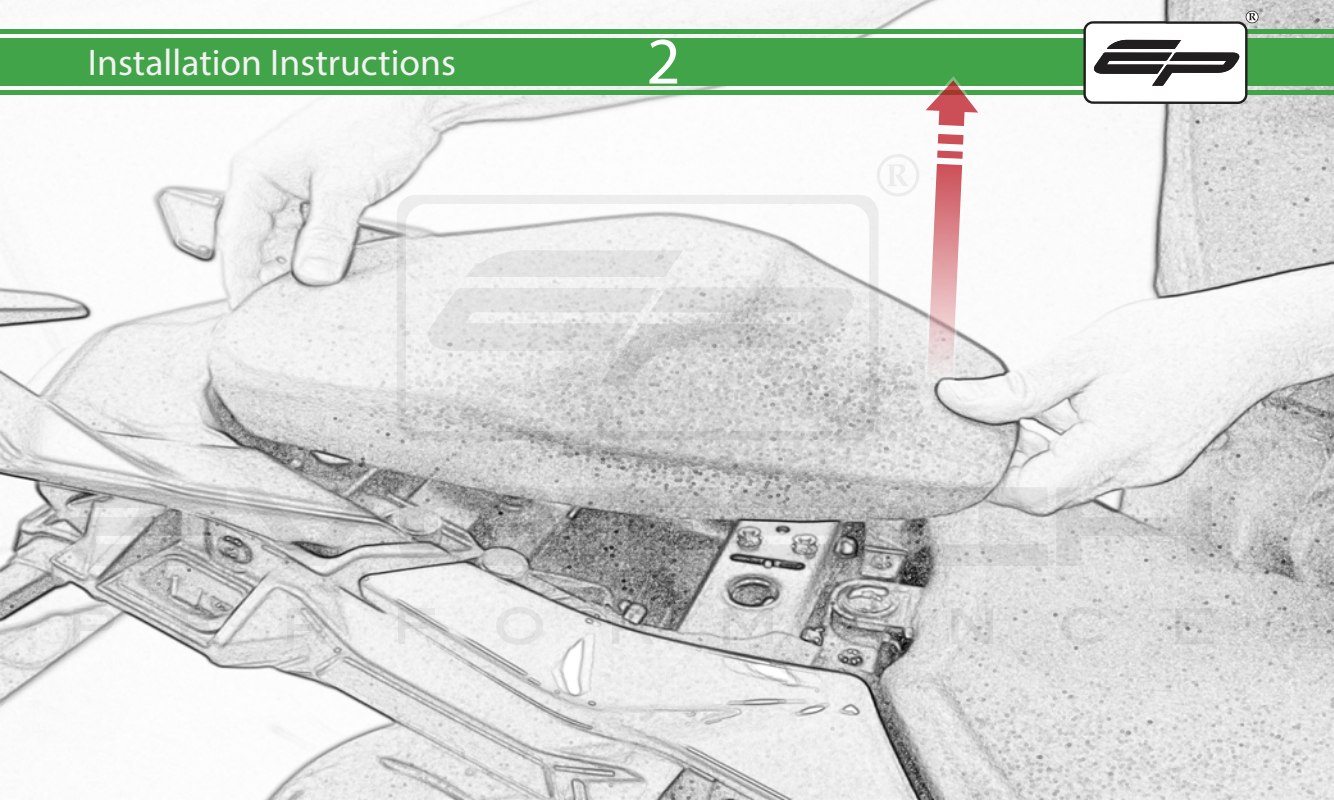



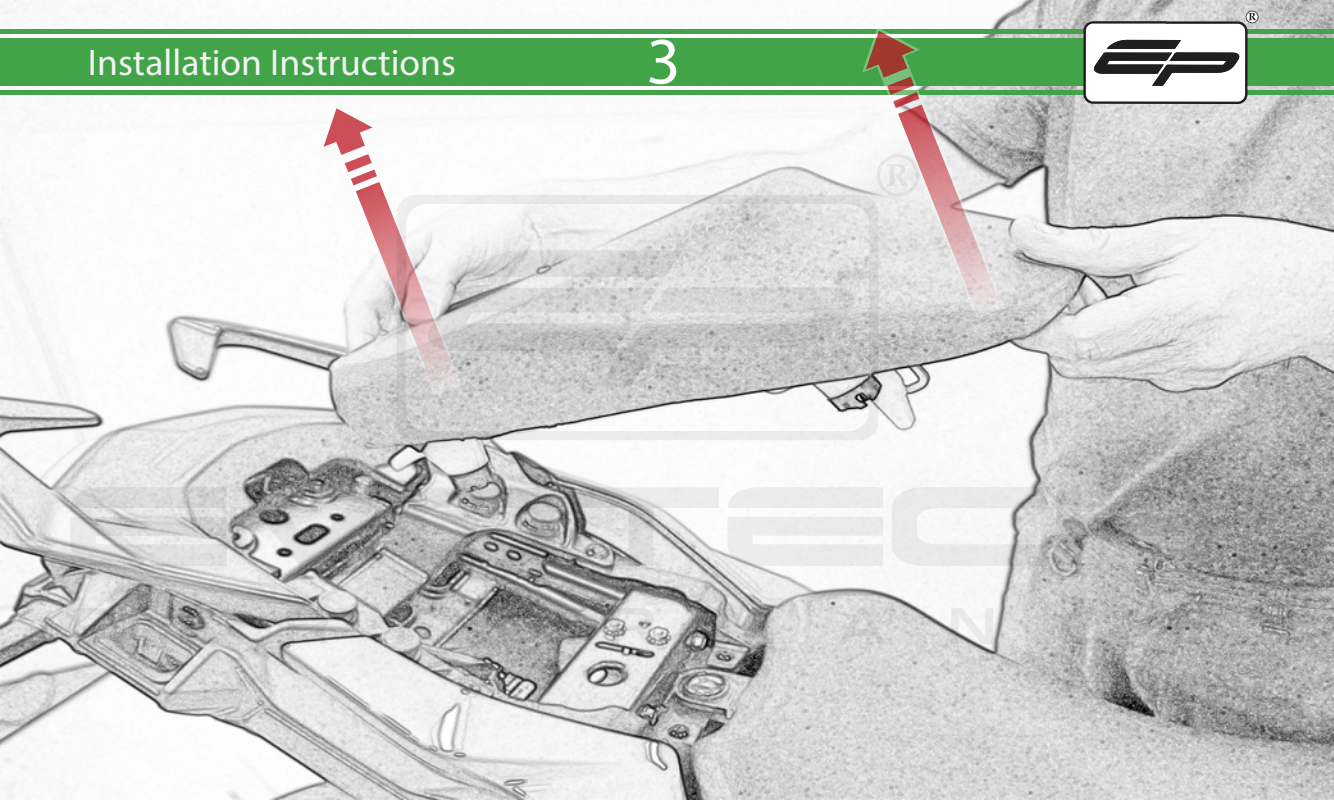

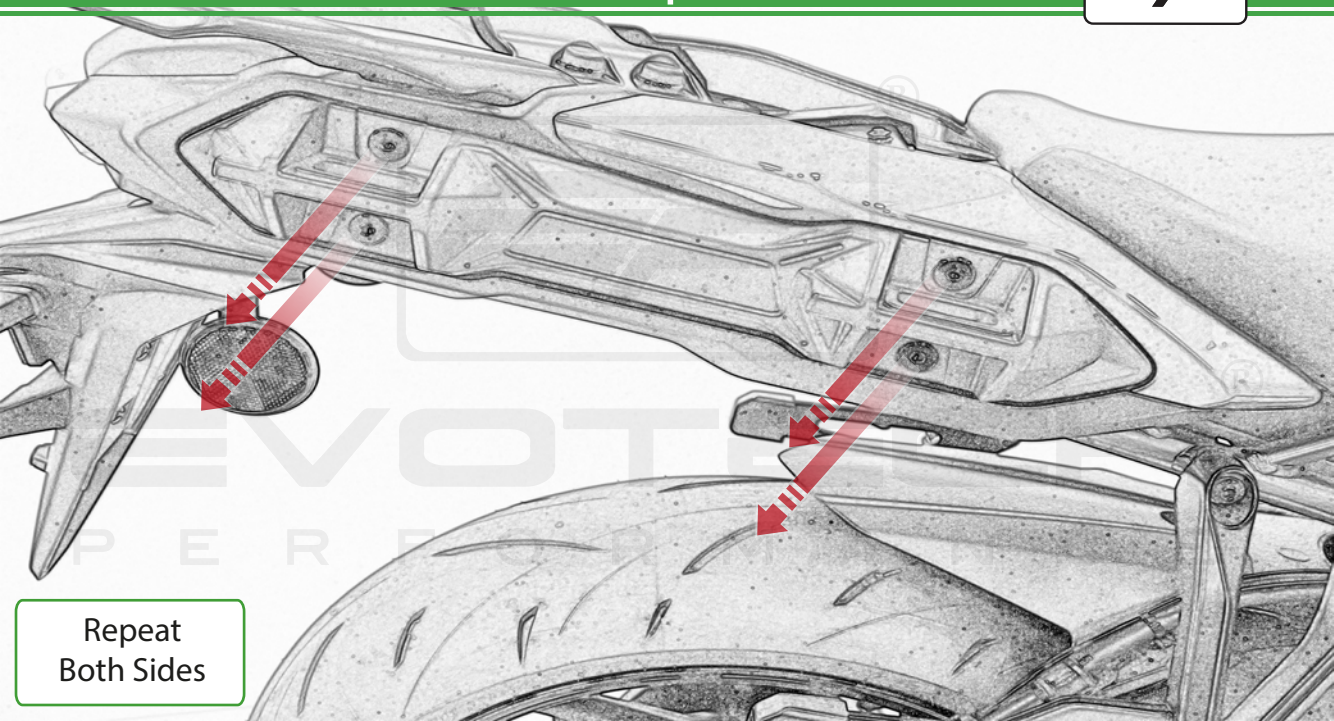

Repeat  
Both Sides

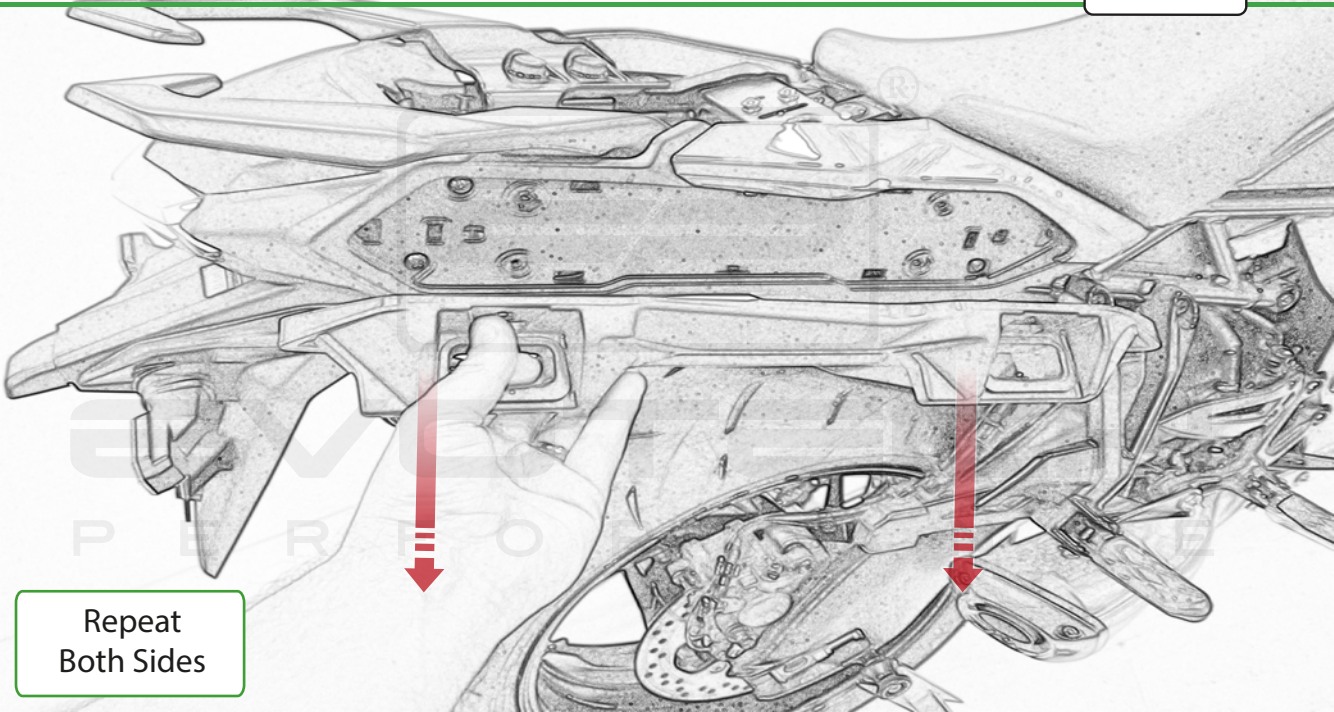

Repeat  
Both Sides

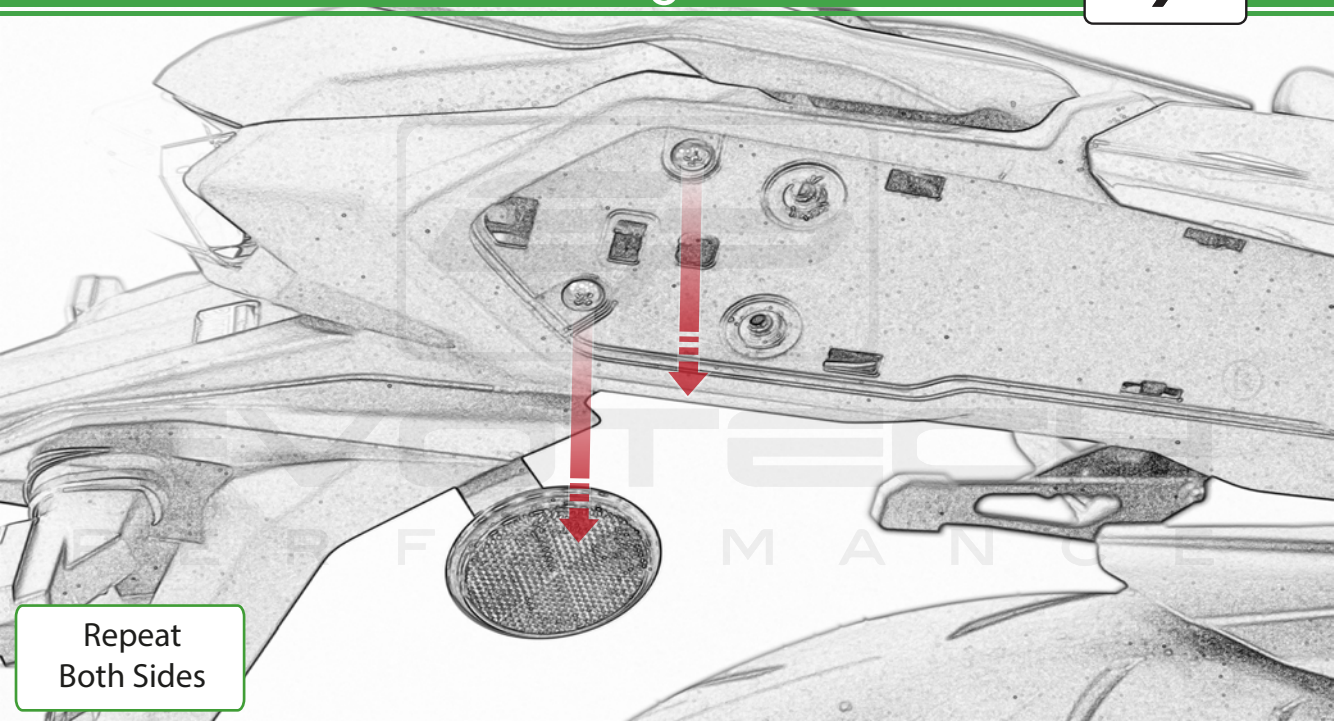

Repeat  
Both Sides



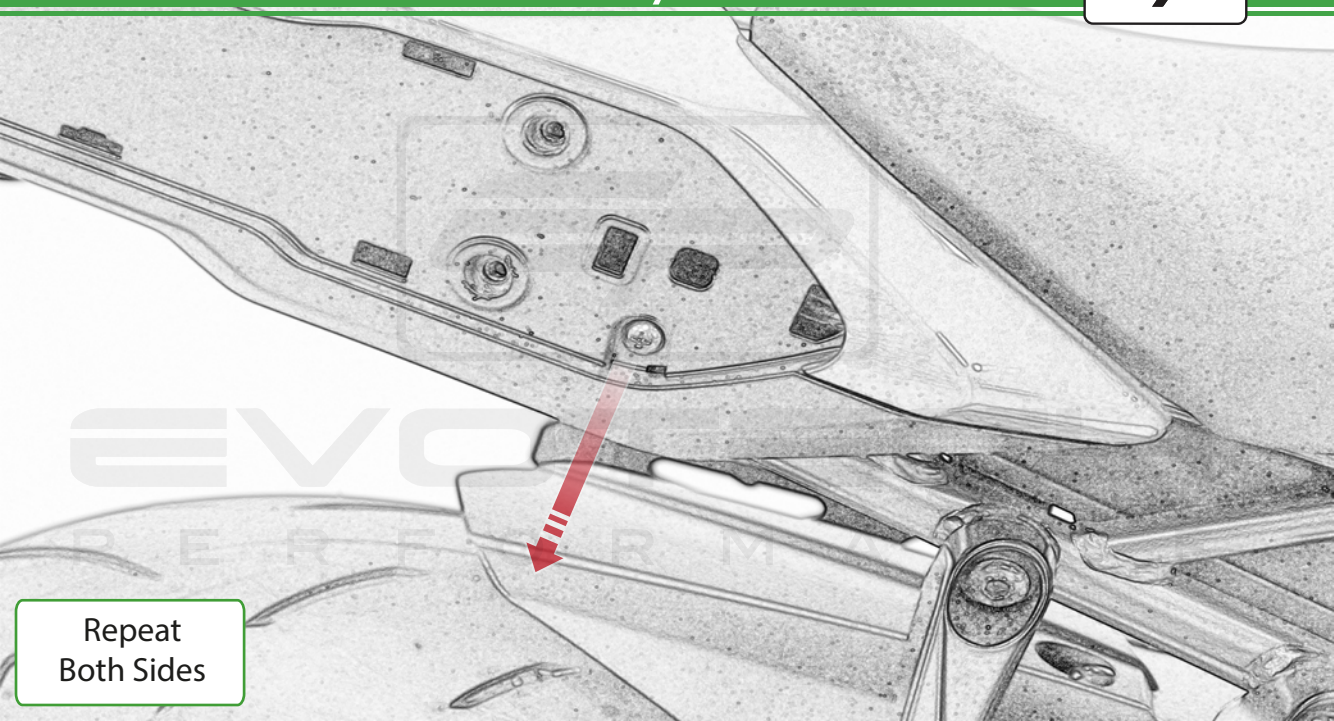

Repeat  
Both Sides

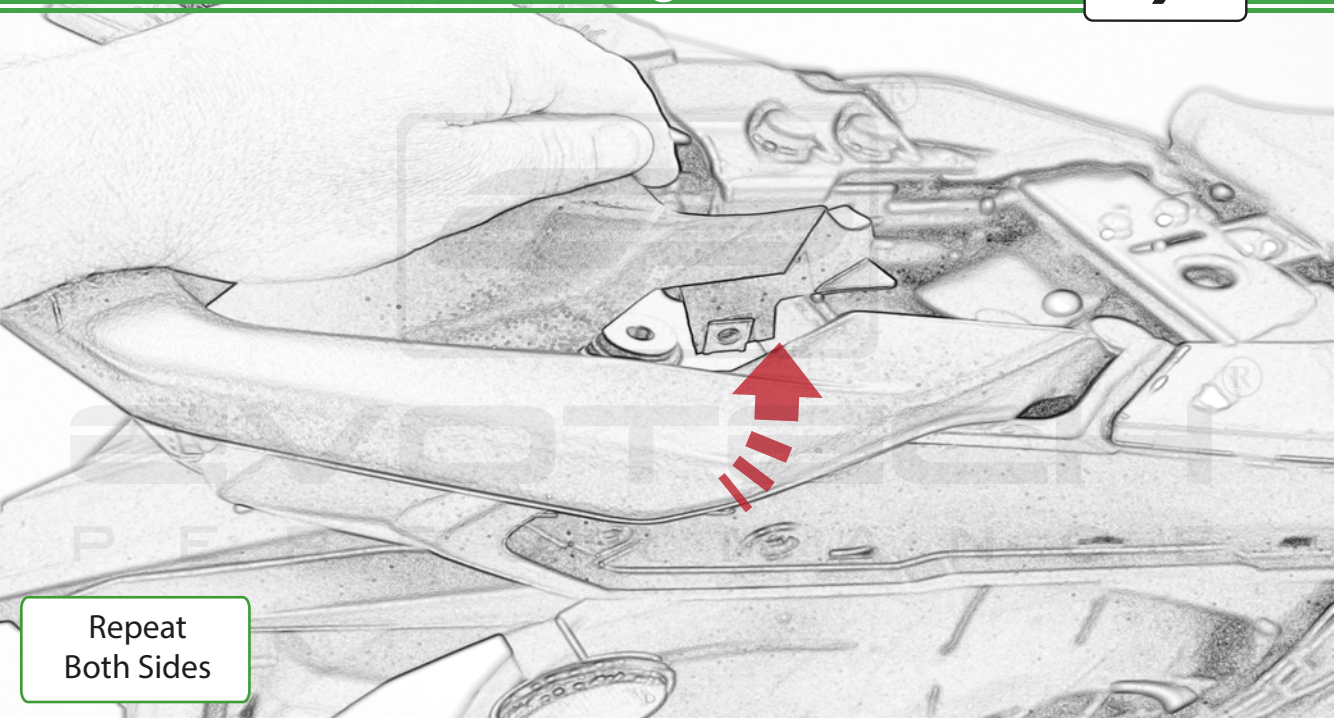

Repeat  
Both Sides

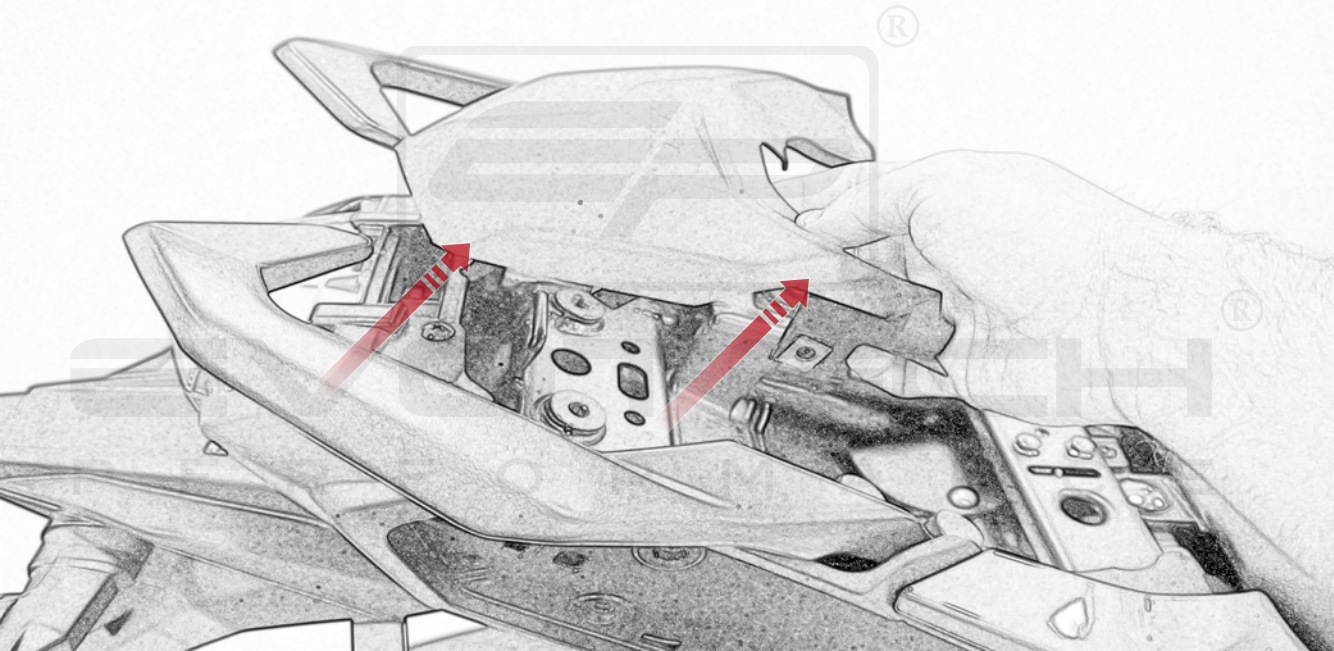



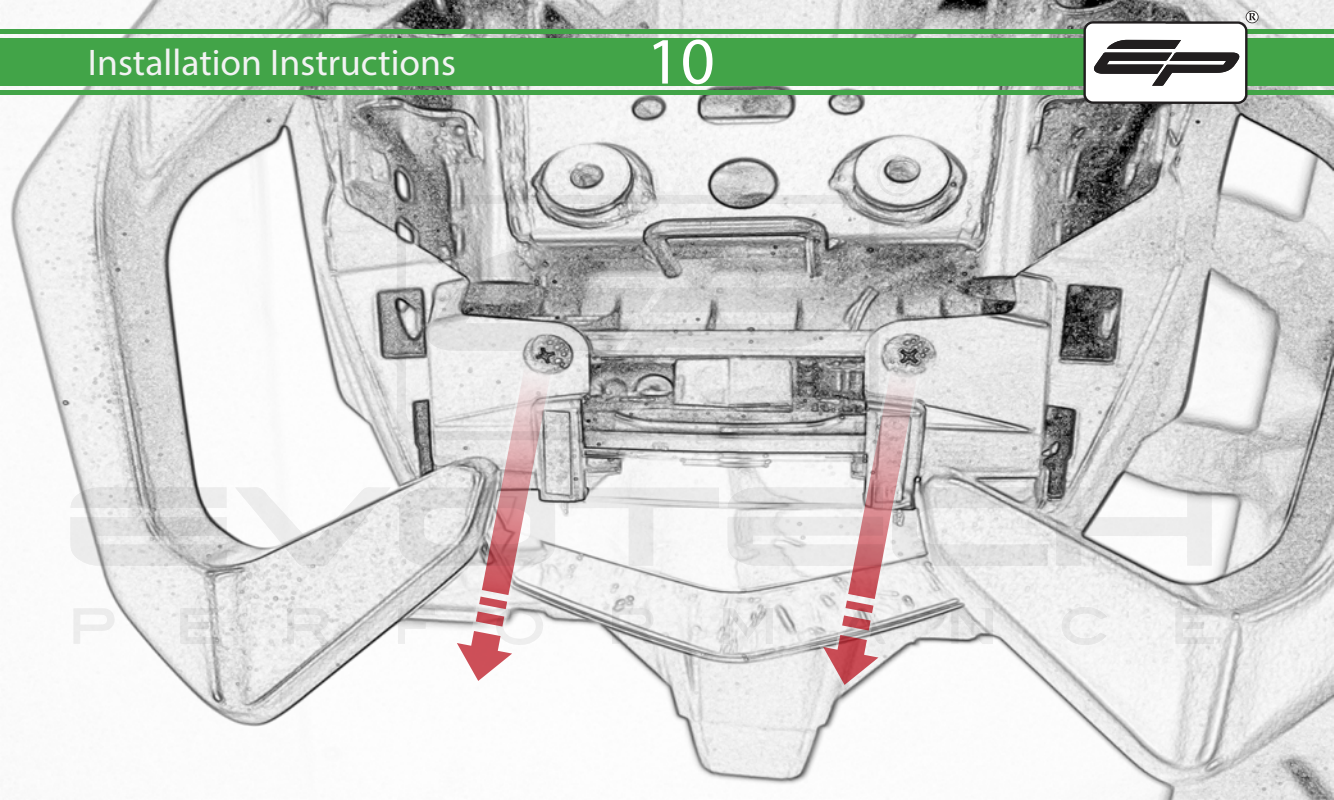

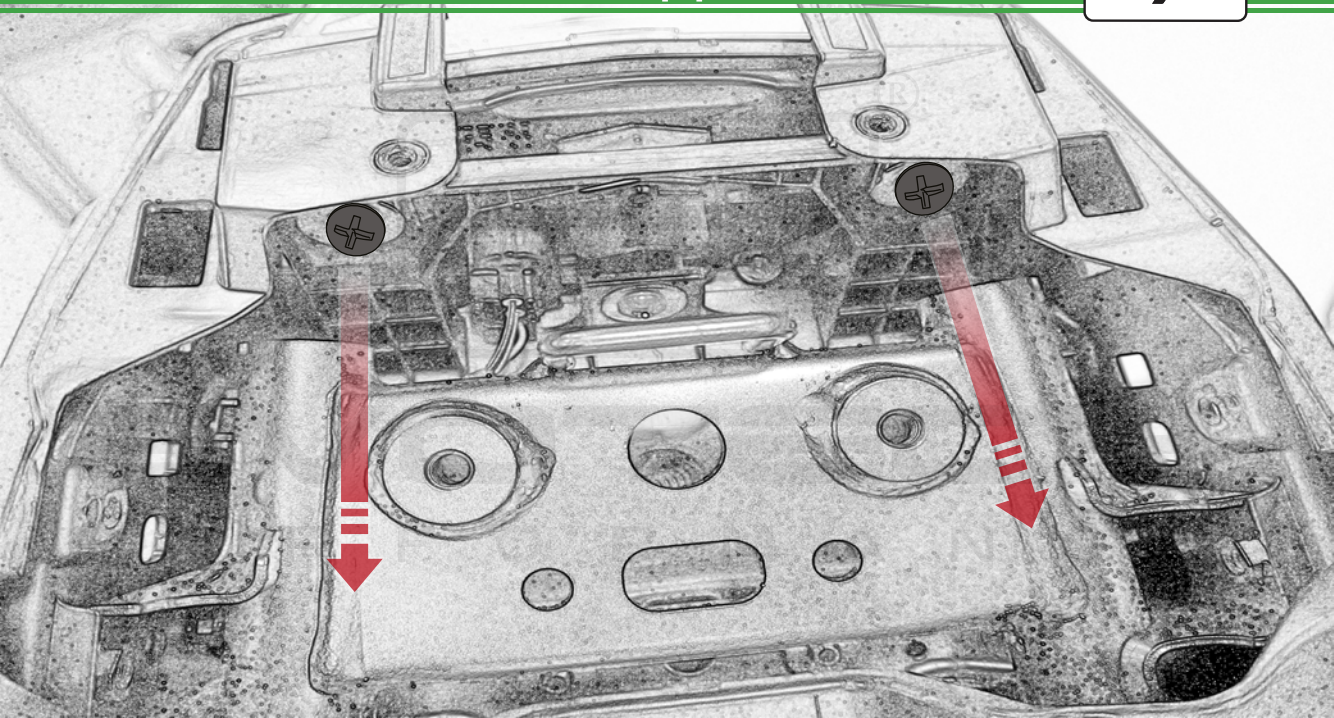

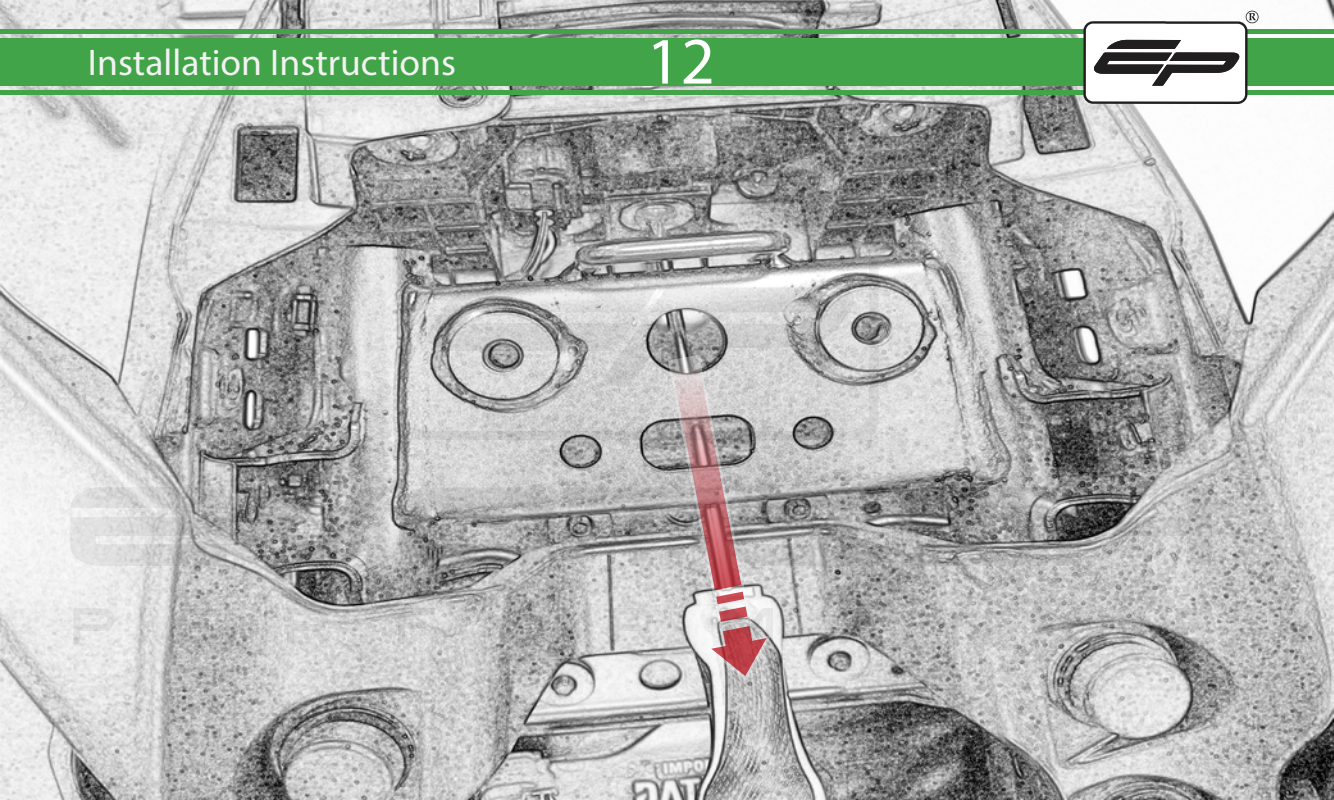



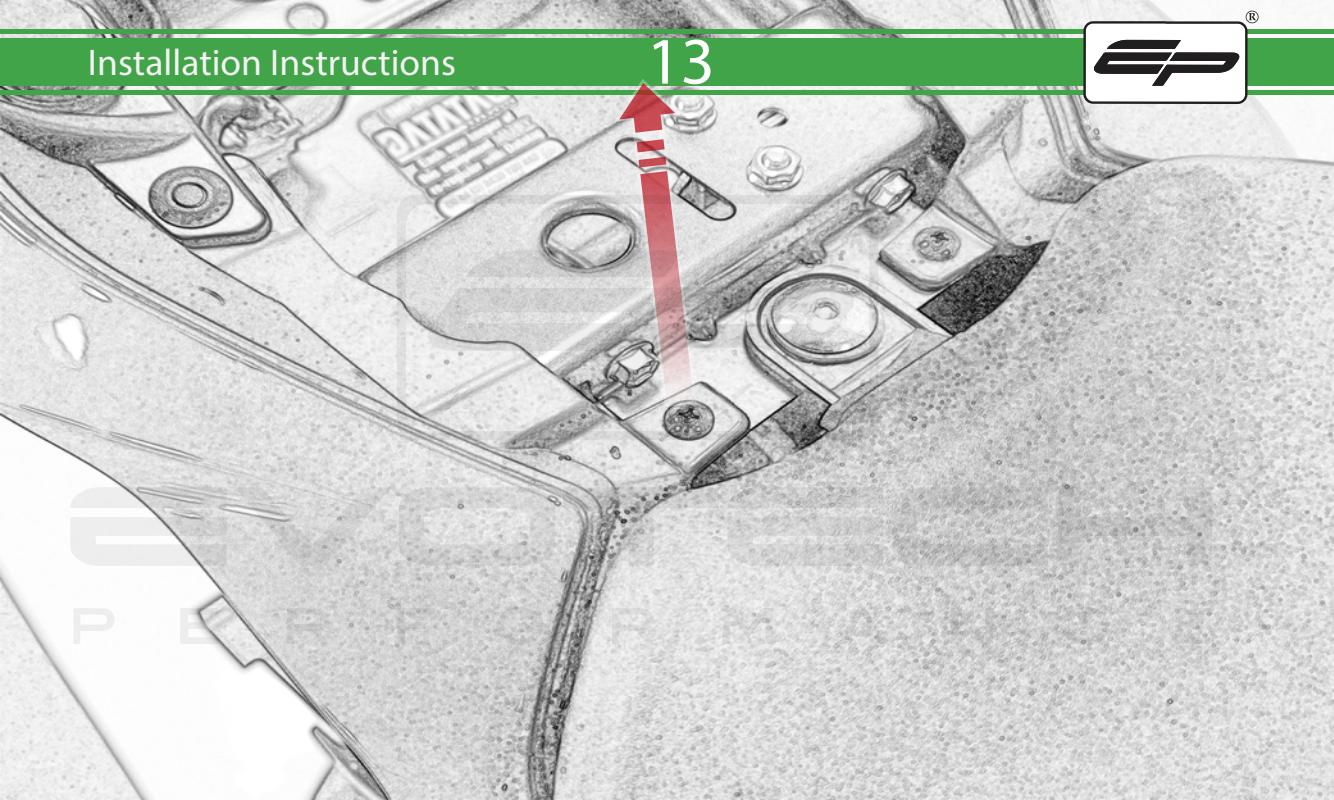



**RELEASE**

**RE-SET**

**RE-FIT**



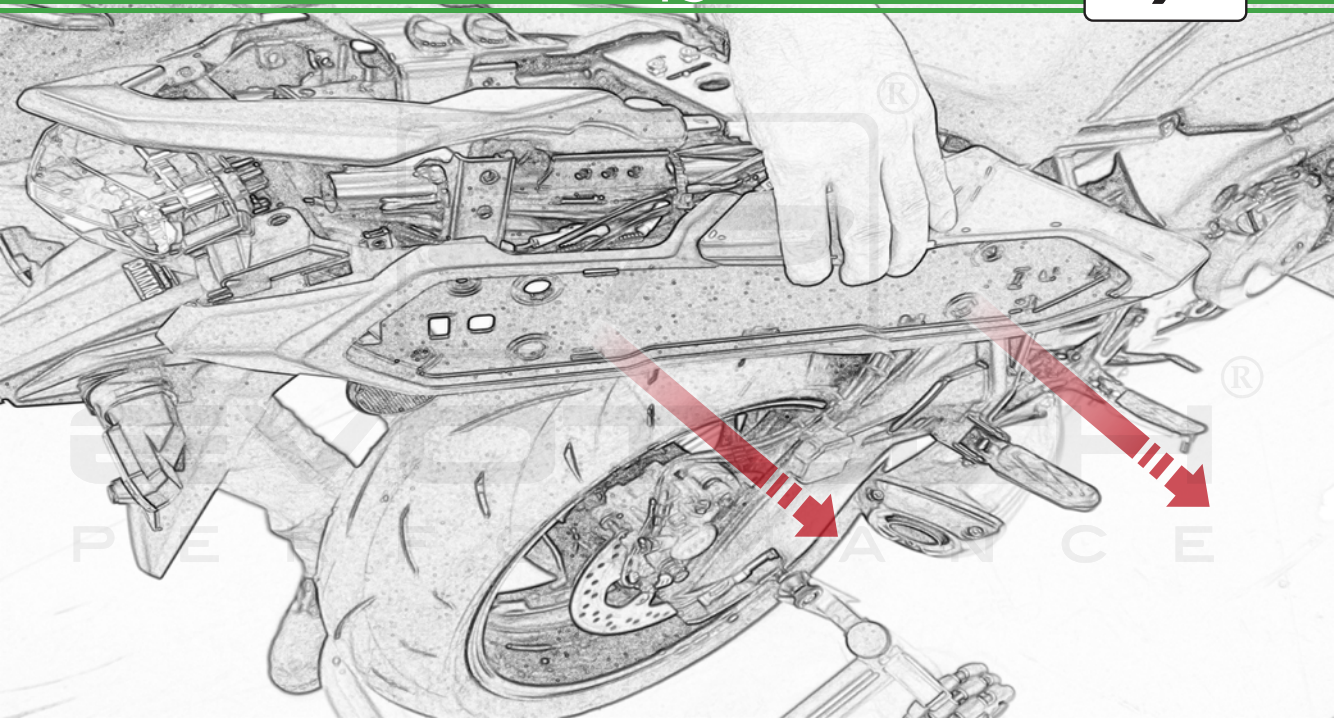



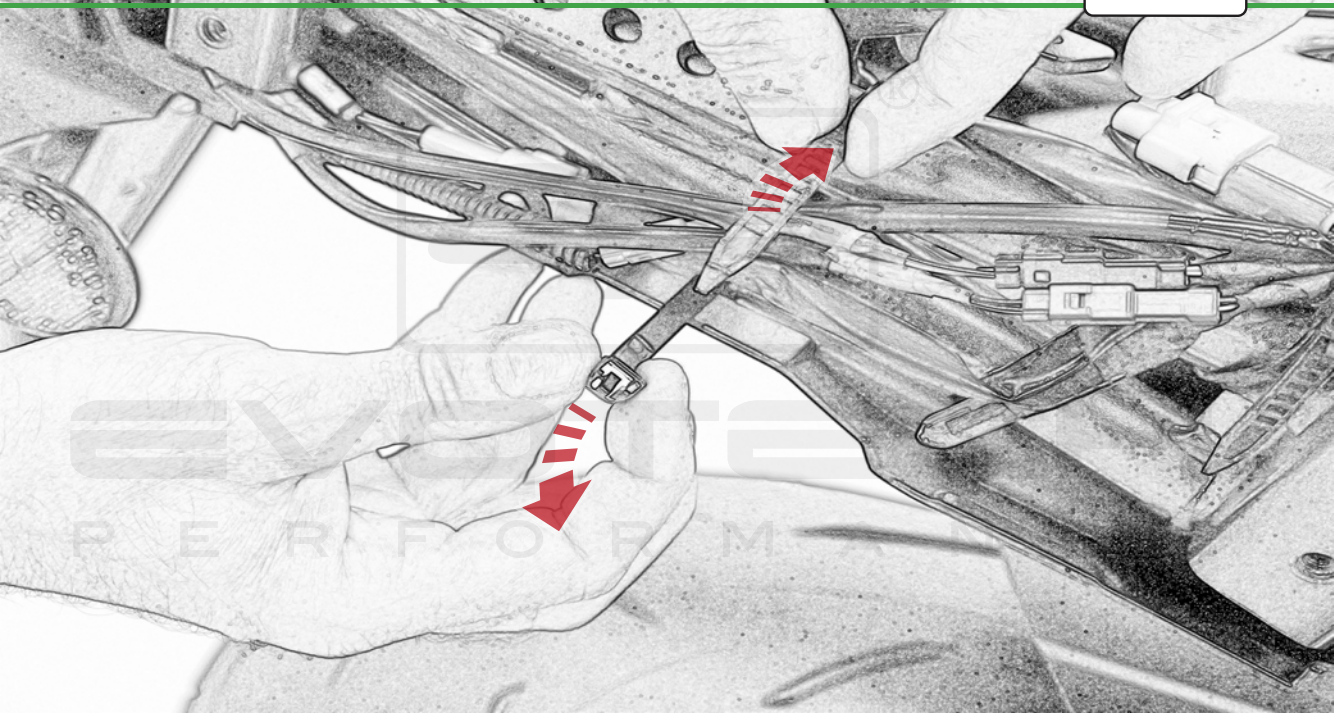

EXTECH  
PERFORMANCE



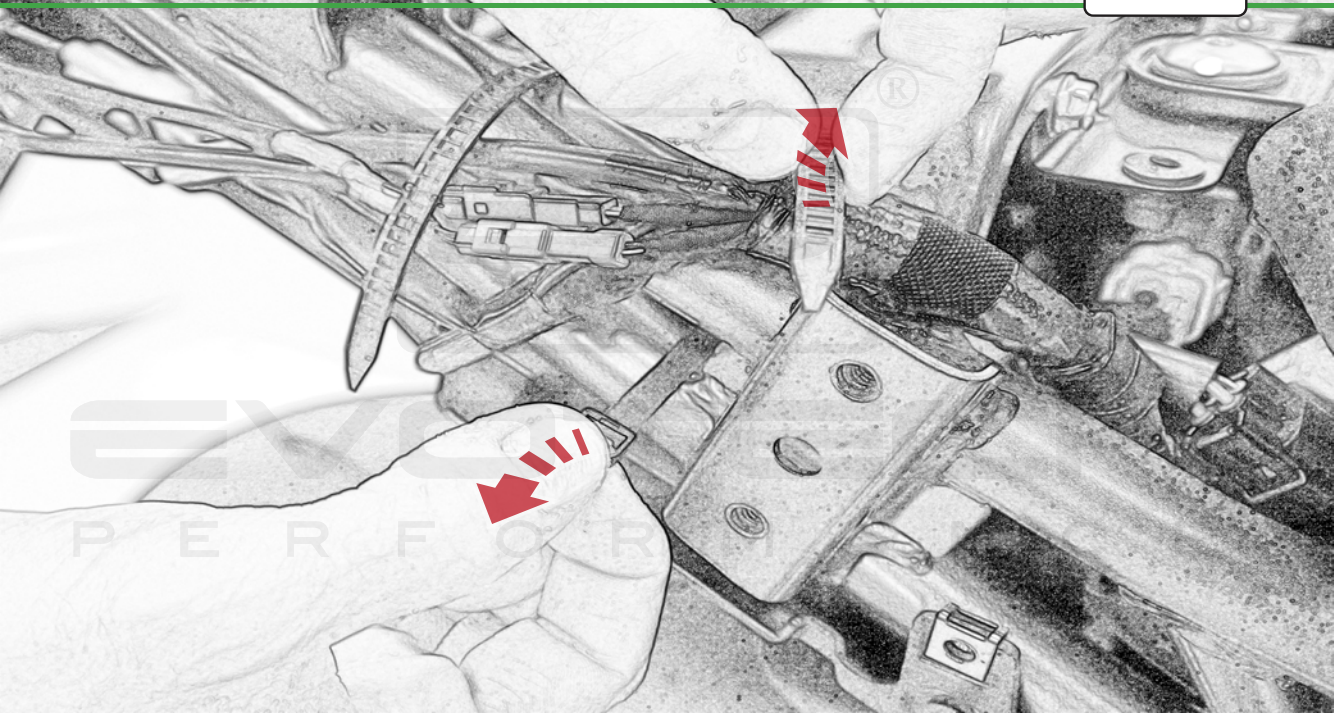

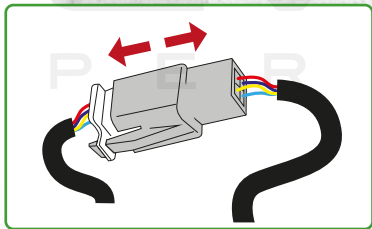
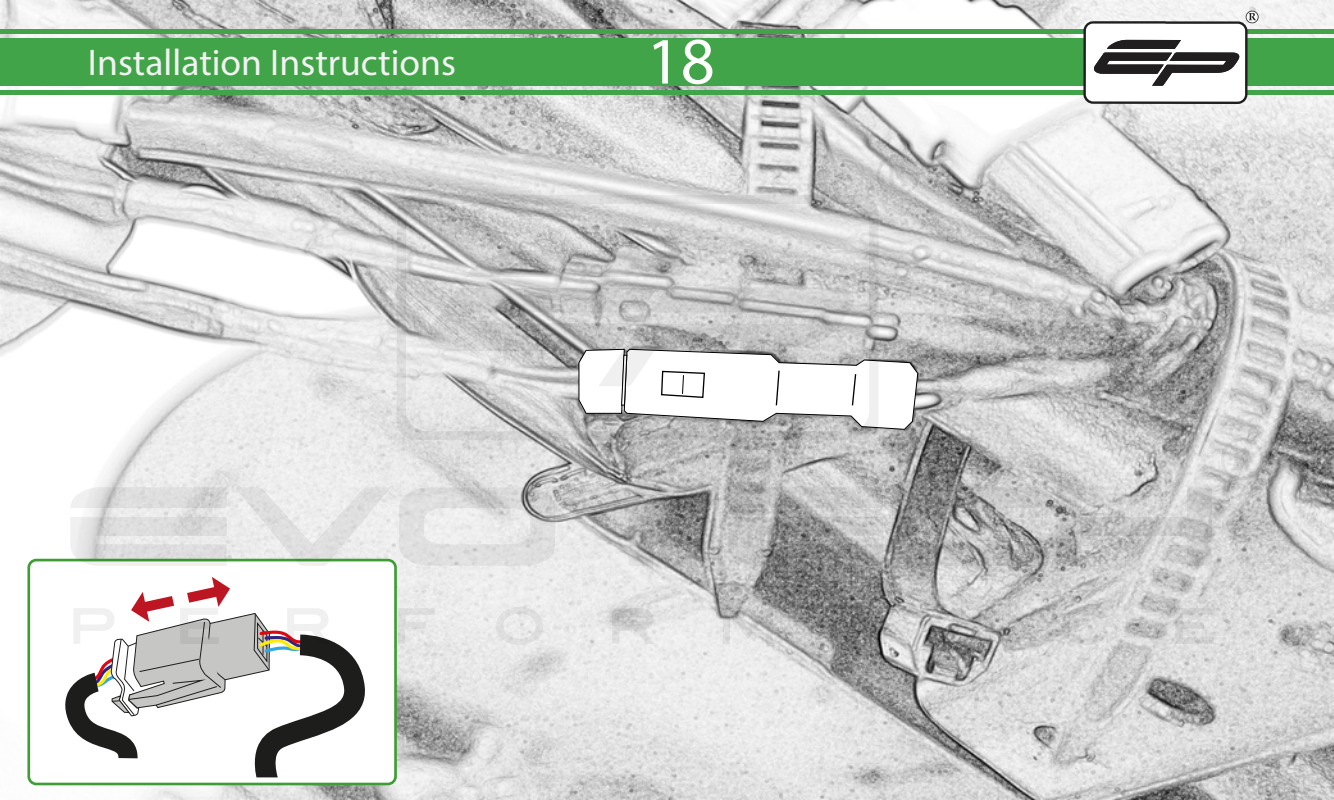

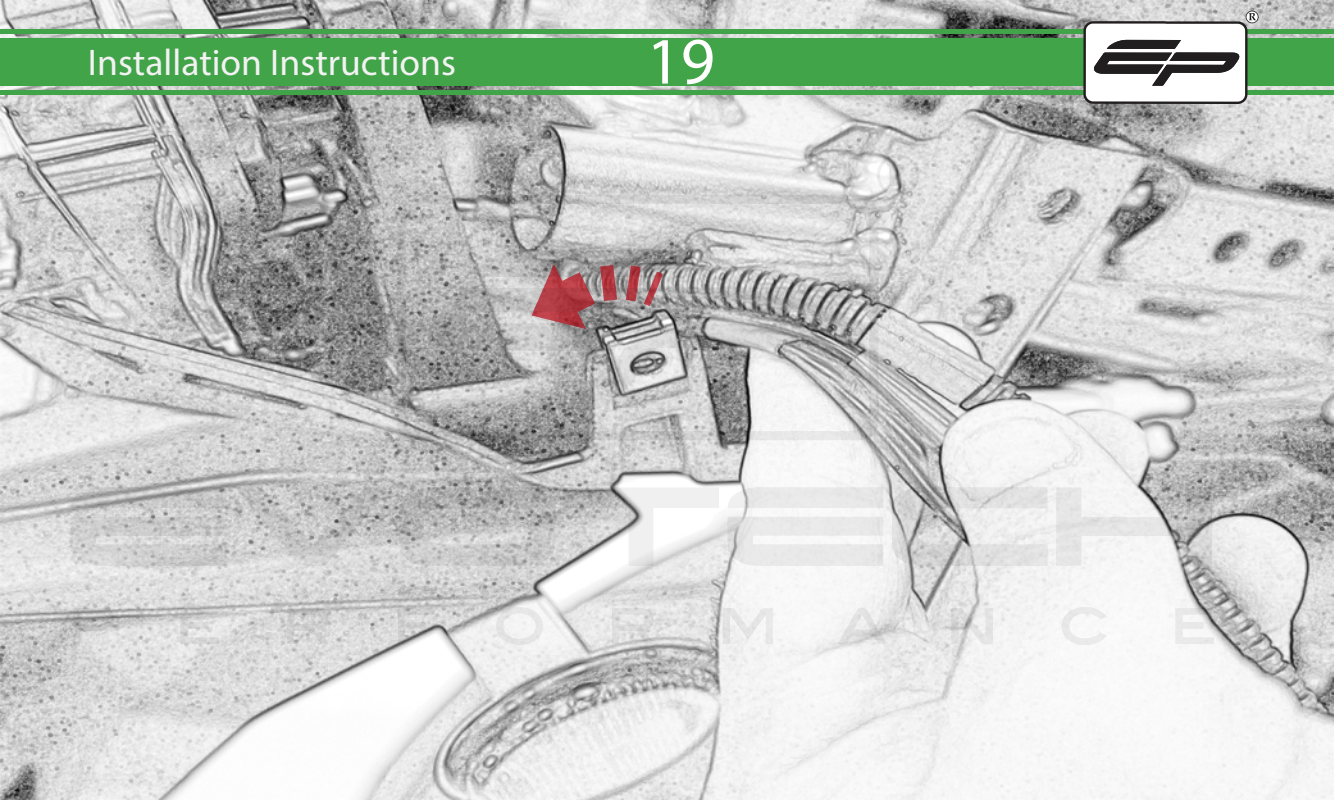



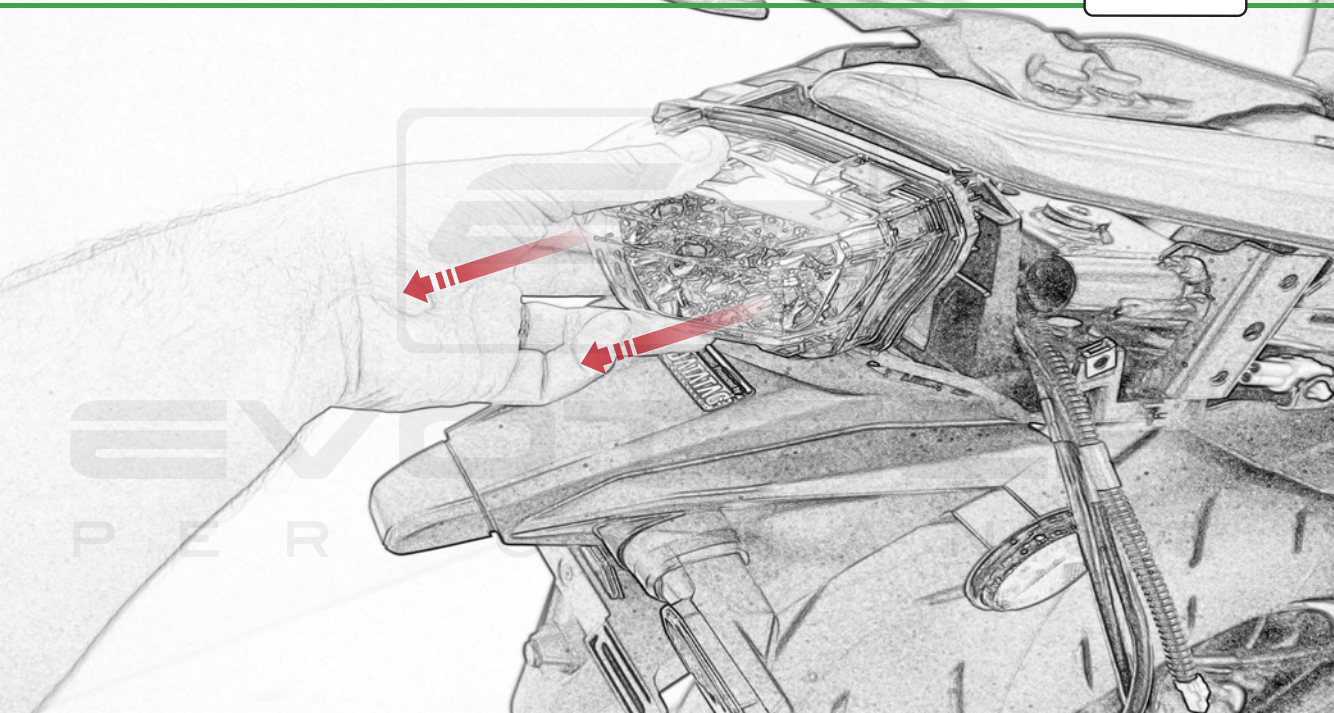

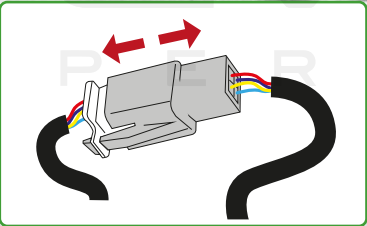
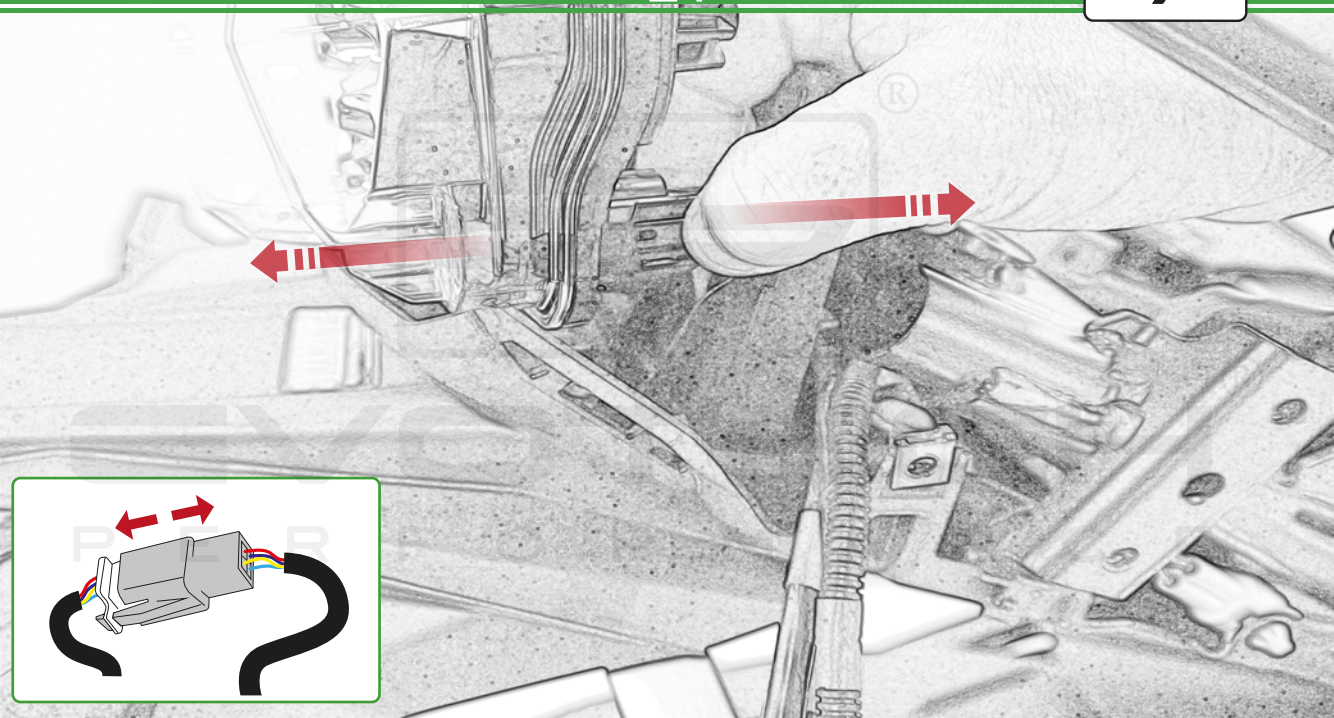



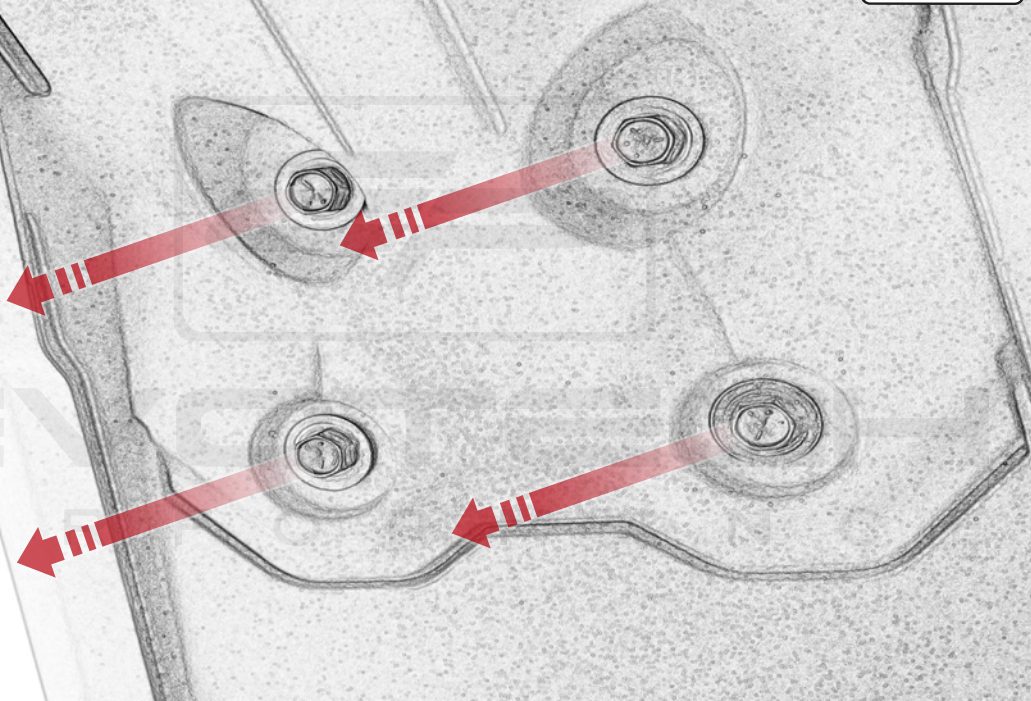



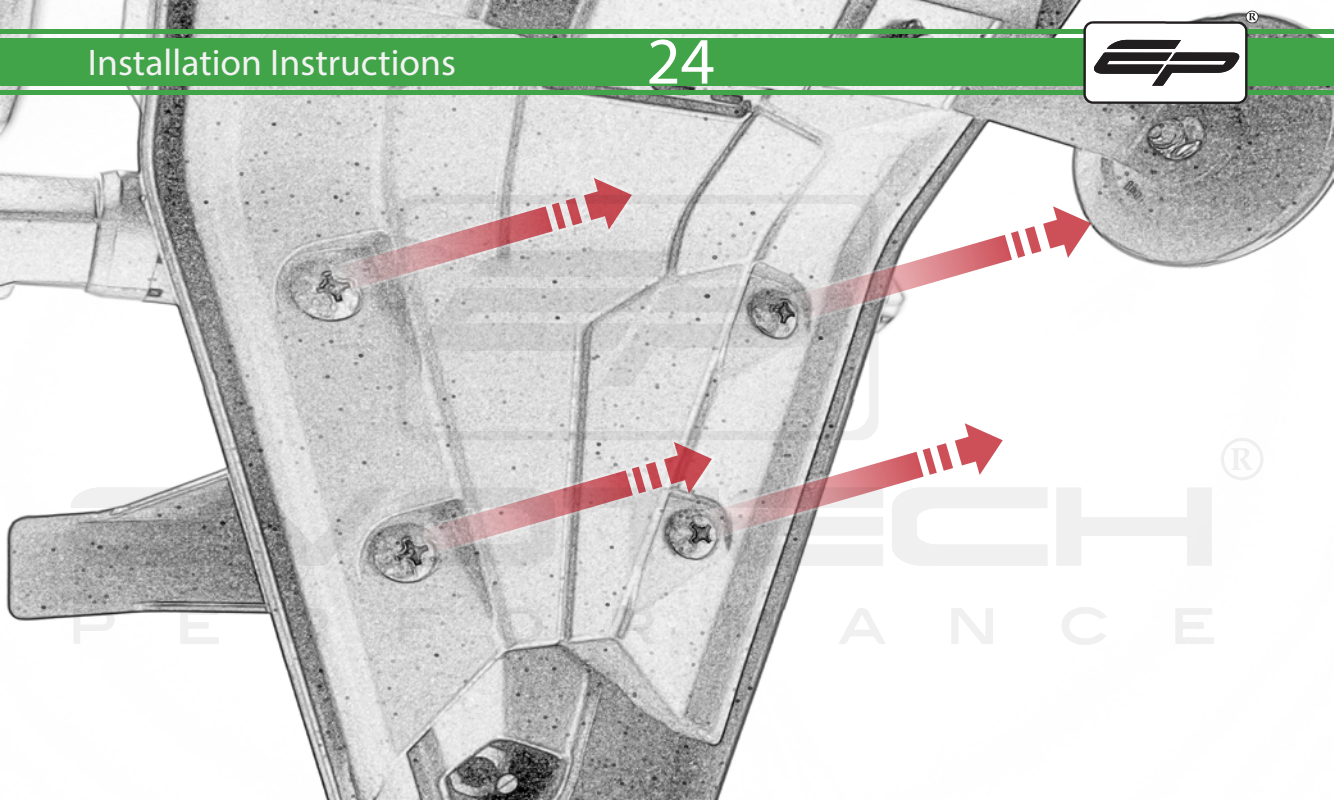

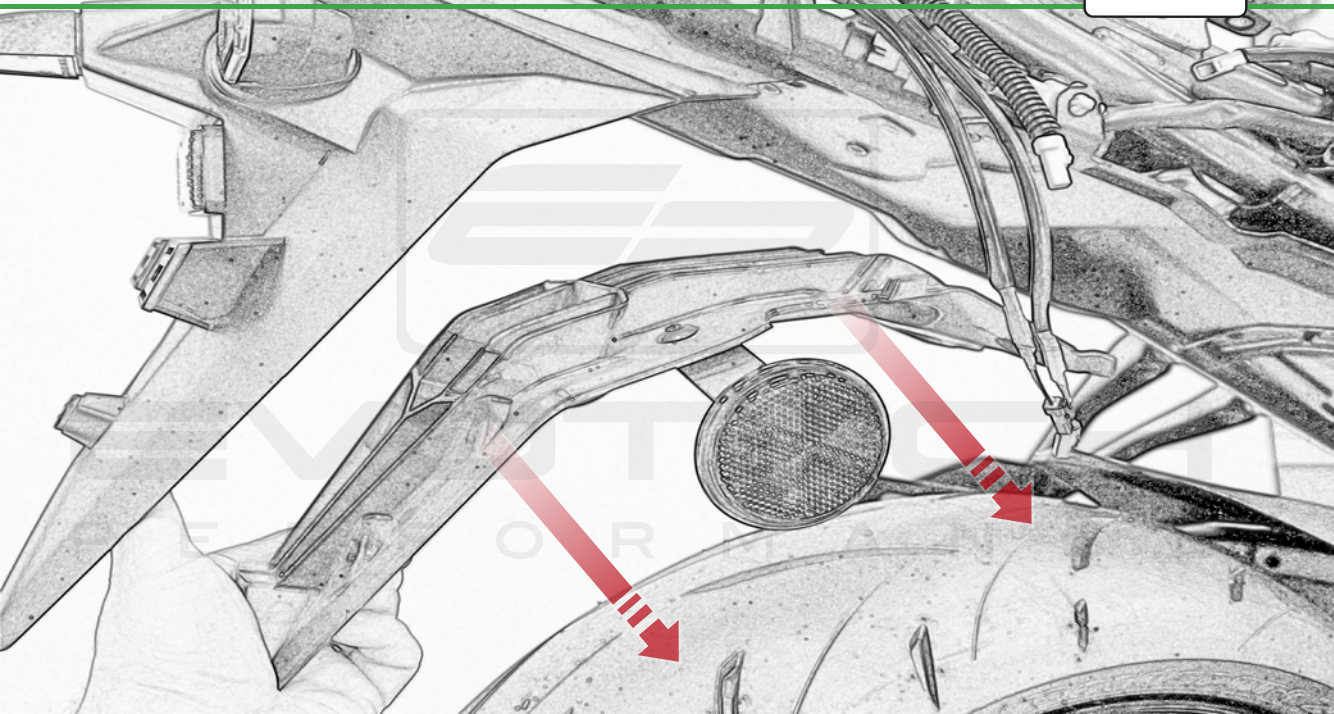

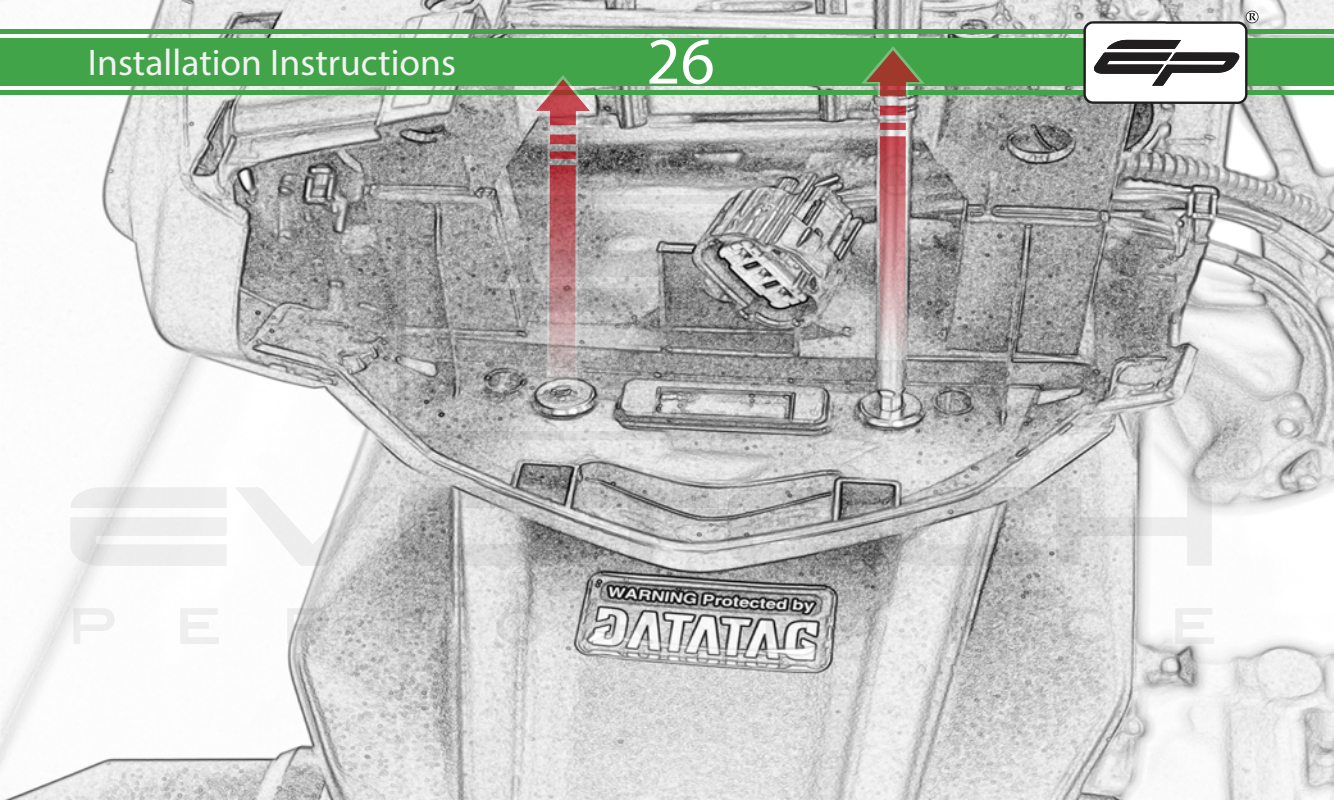

WARNING Protected by  
PATENT





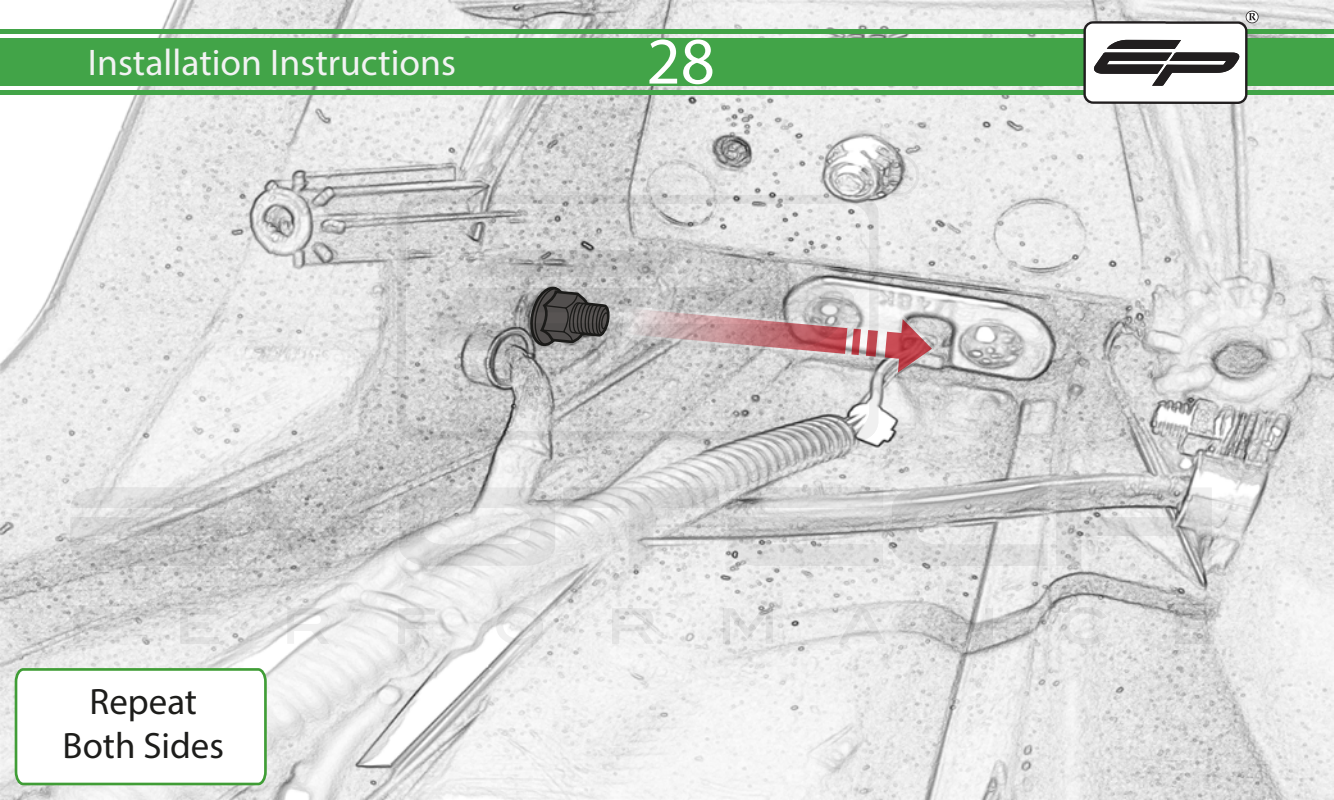

Repeat  
Both Sides

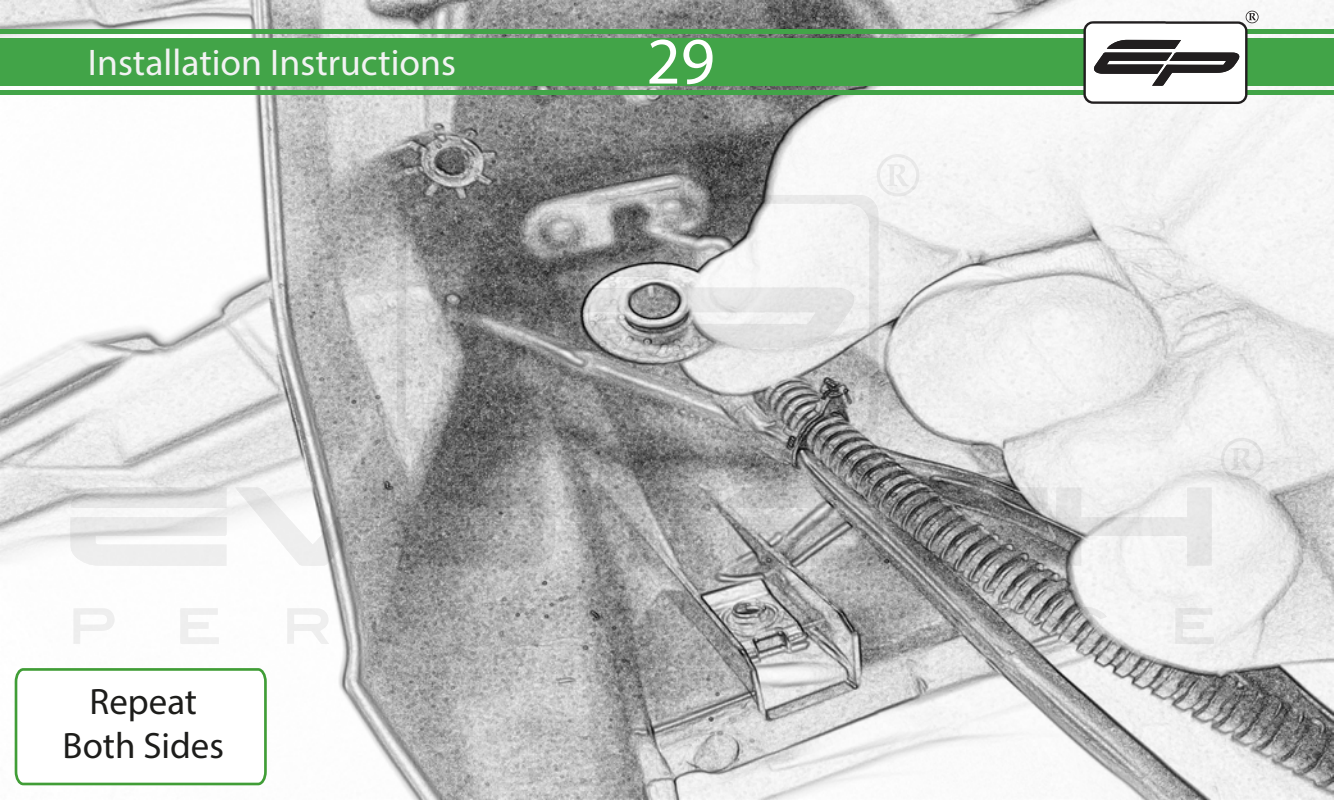

Repeat  
Both Sides

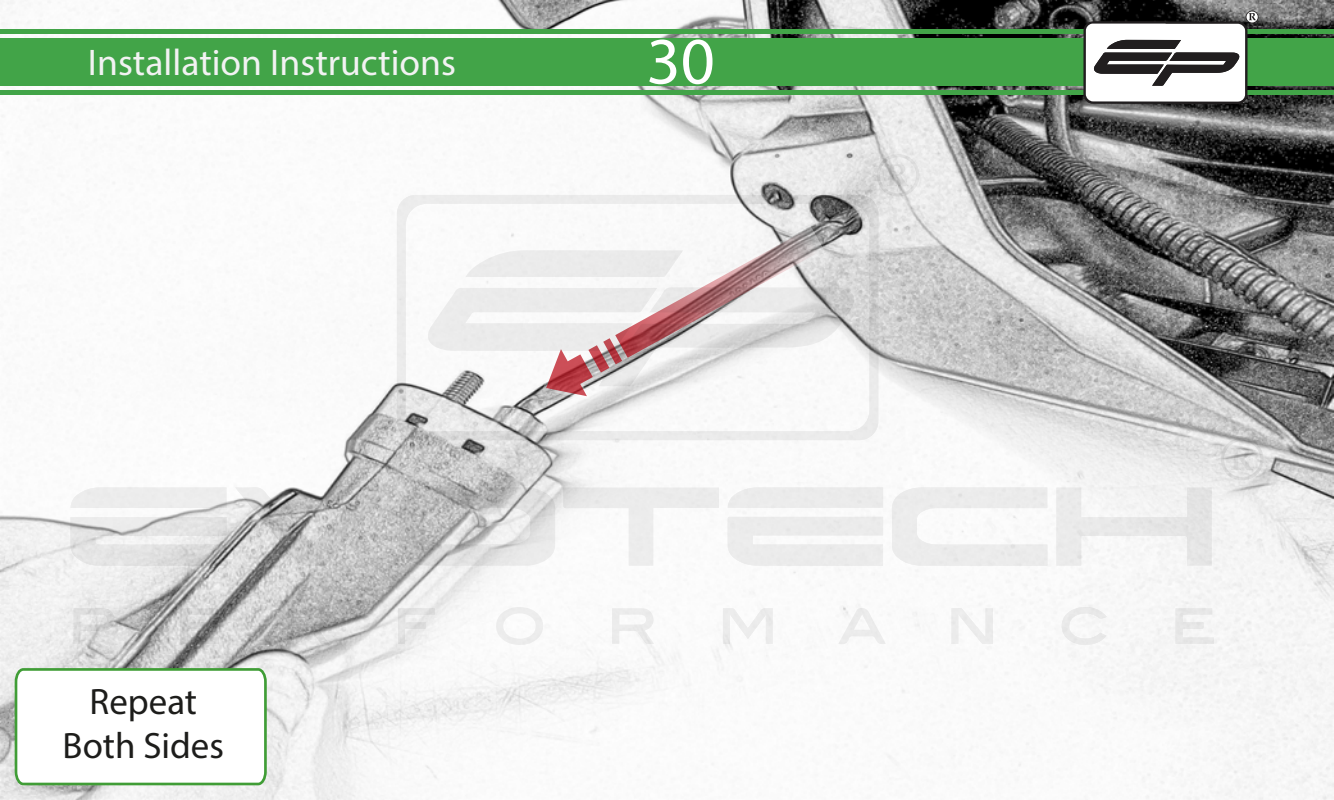

Repeat  
Both Sides

EP  
PERFORMANCE



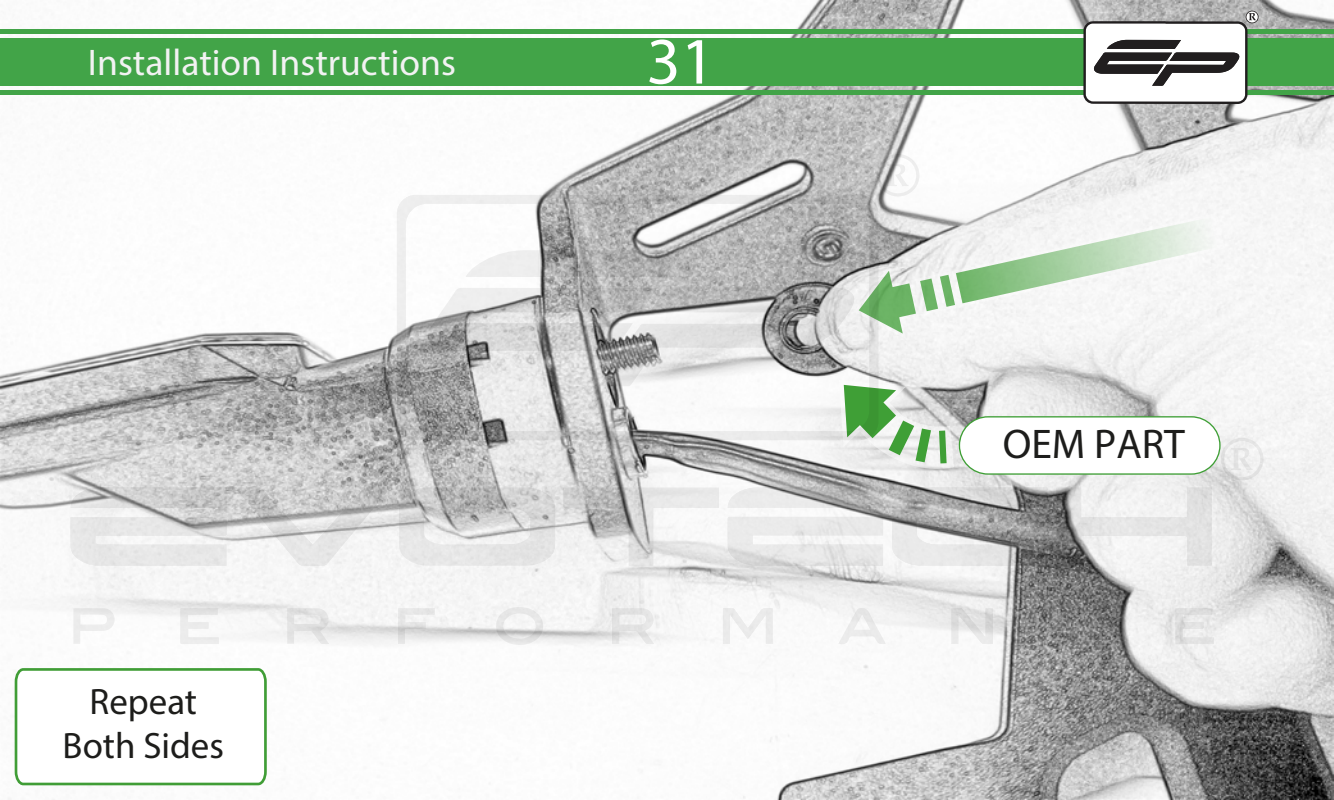

OEM PART

Repeat  
Both Sides

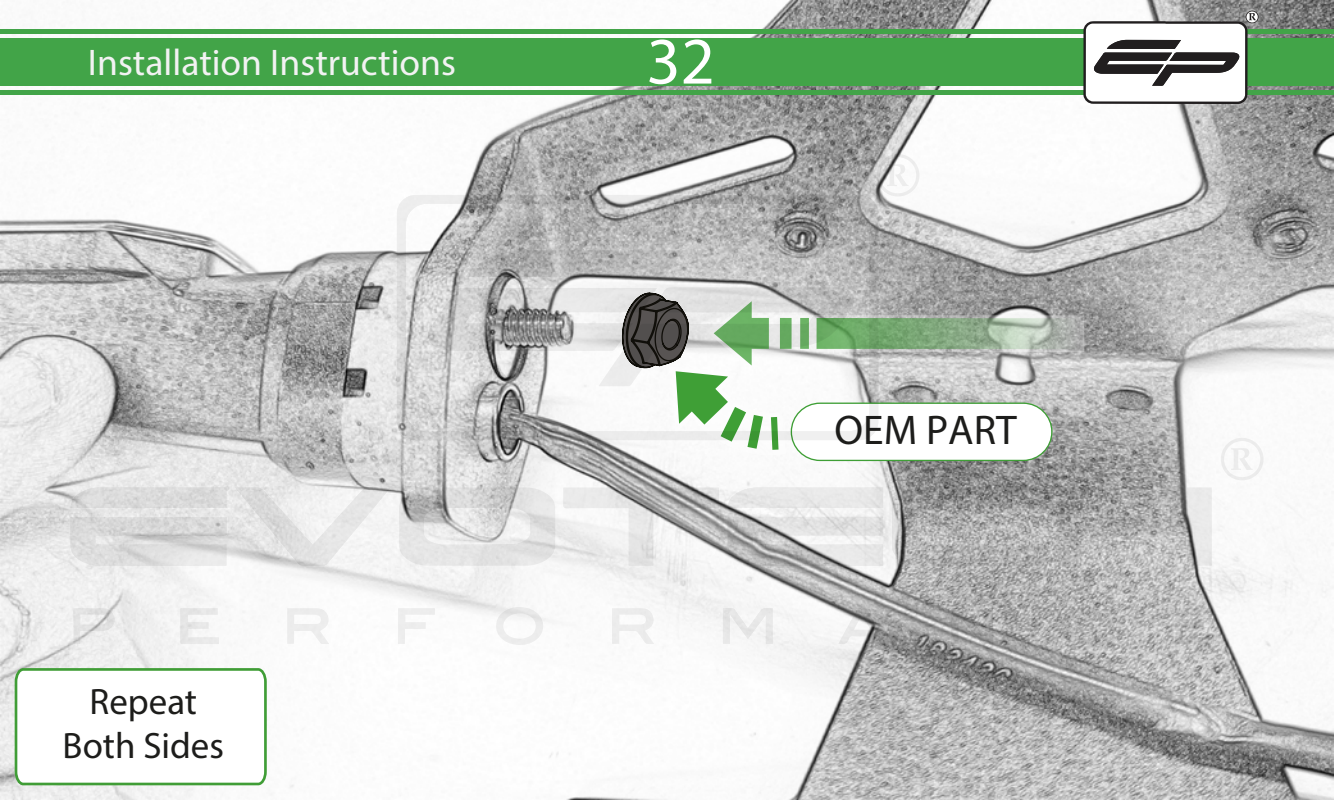

OEM PART

Repeat  
Both Sides

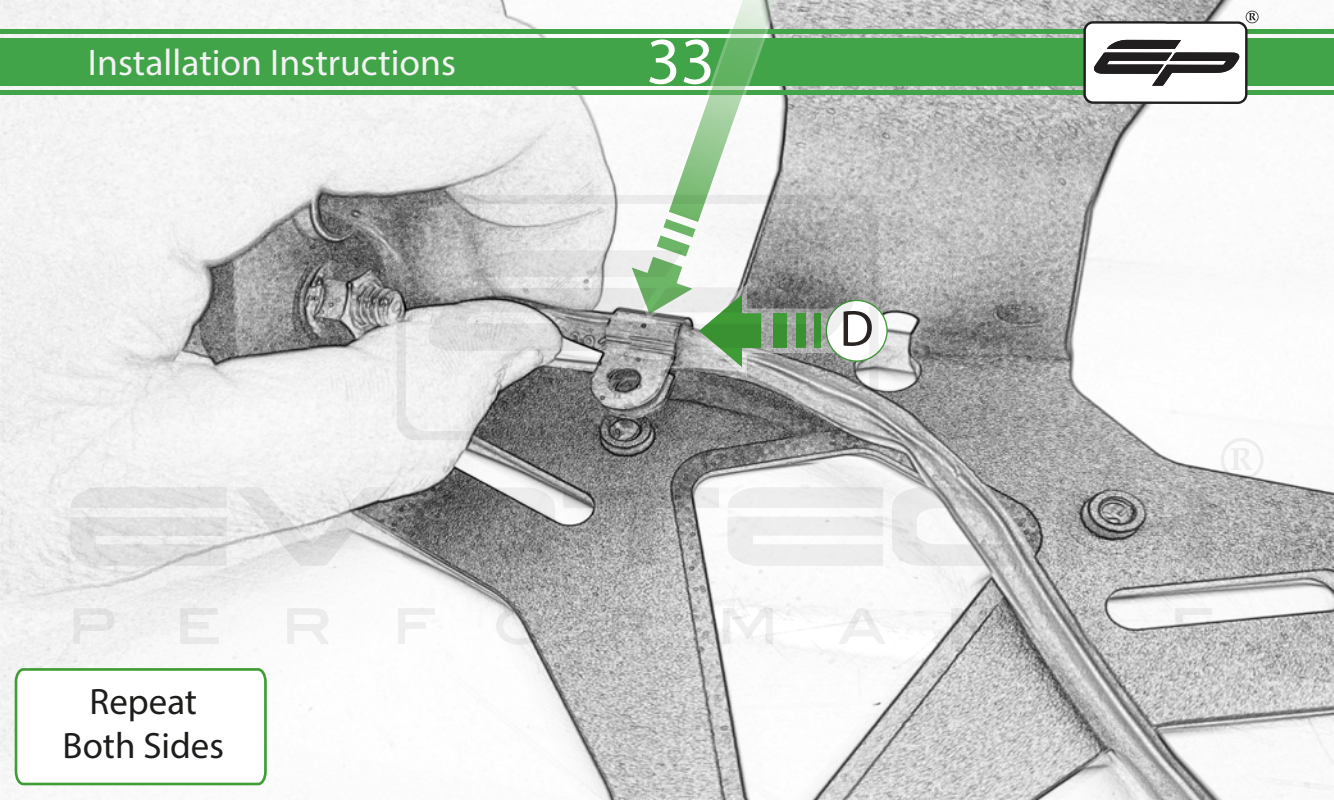

Repeat  
Both Sides

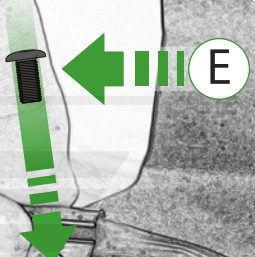
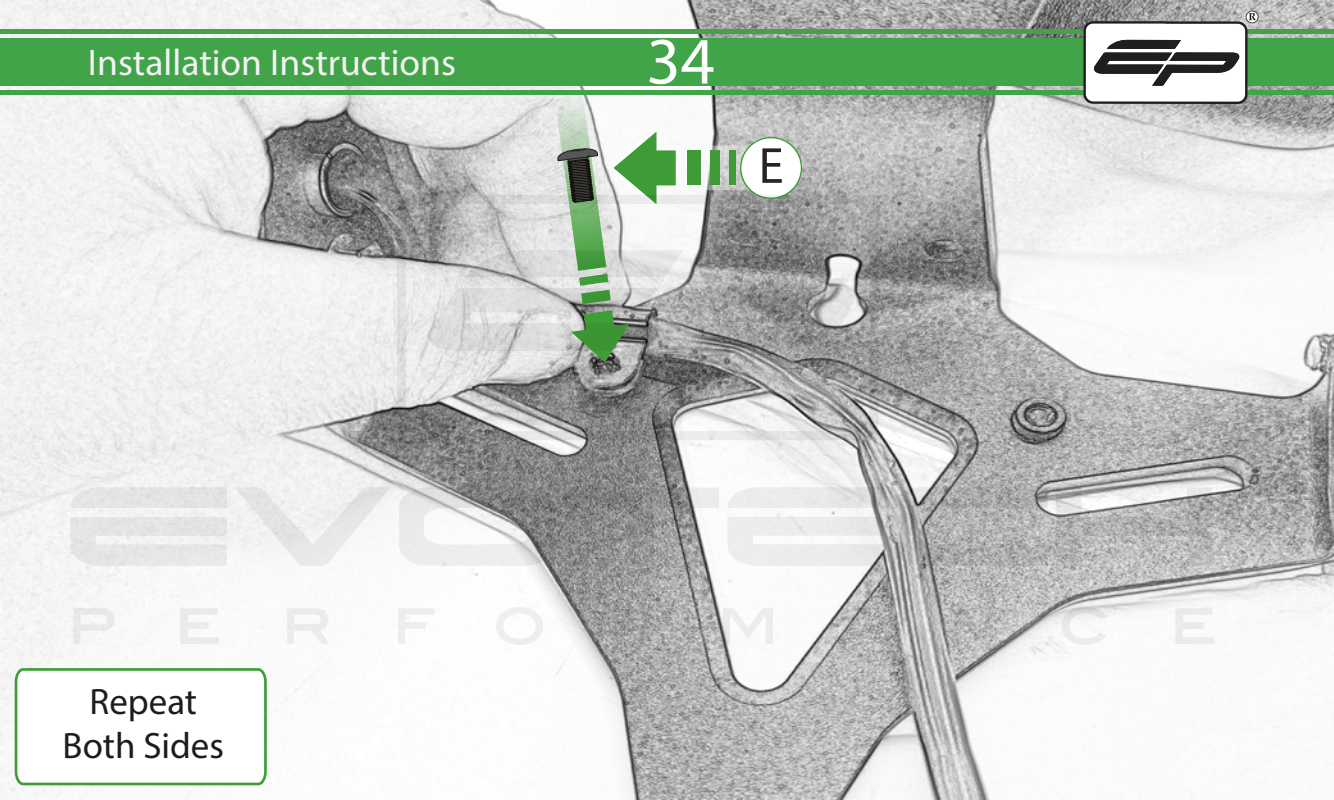

EVO  
P E R F O M  
C E

Repeat  
Both Sides



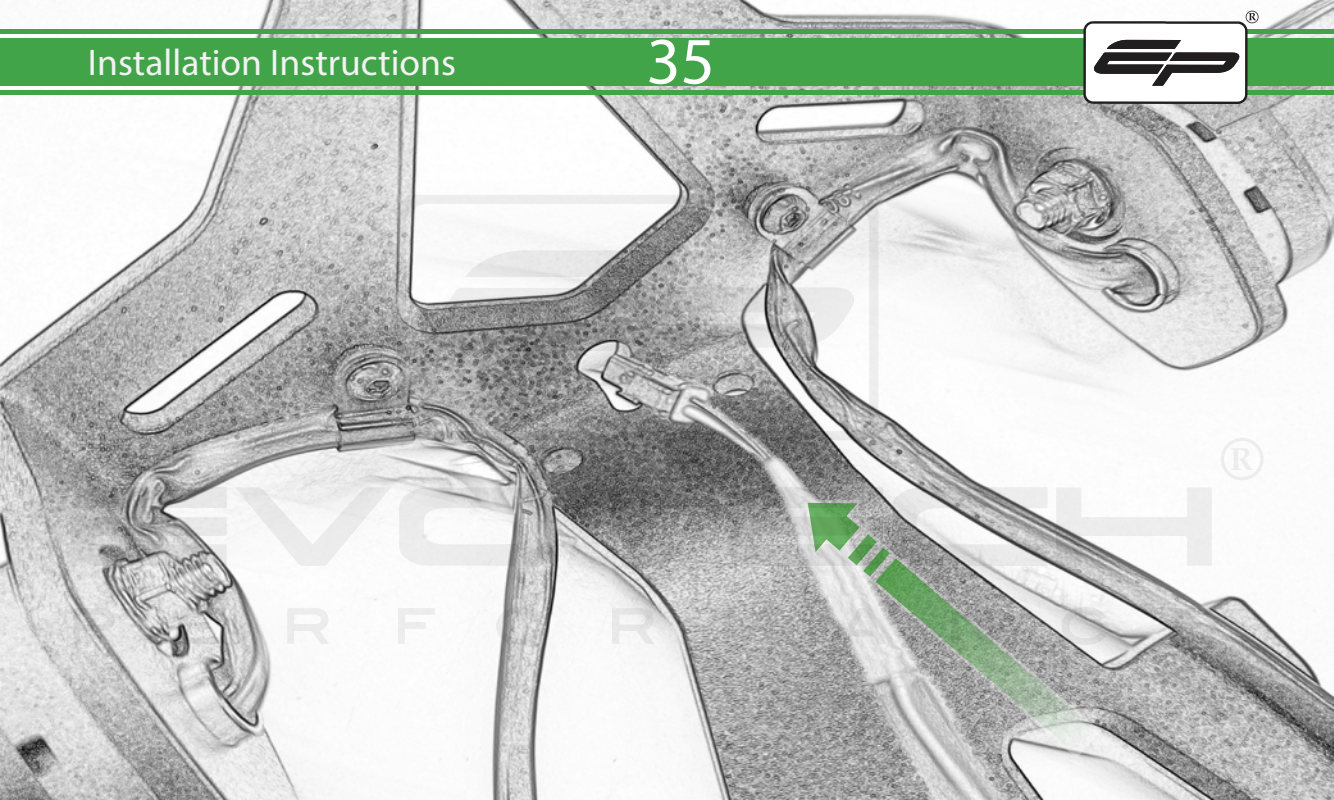

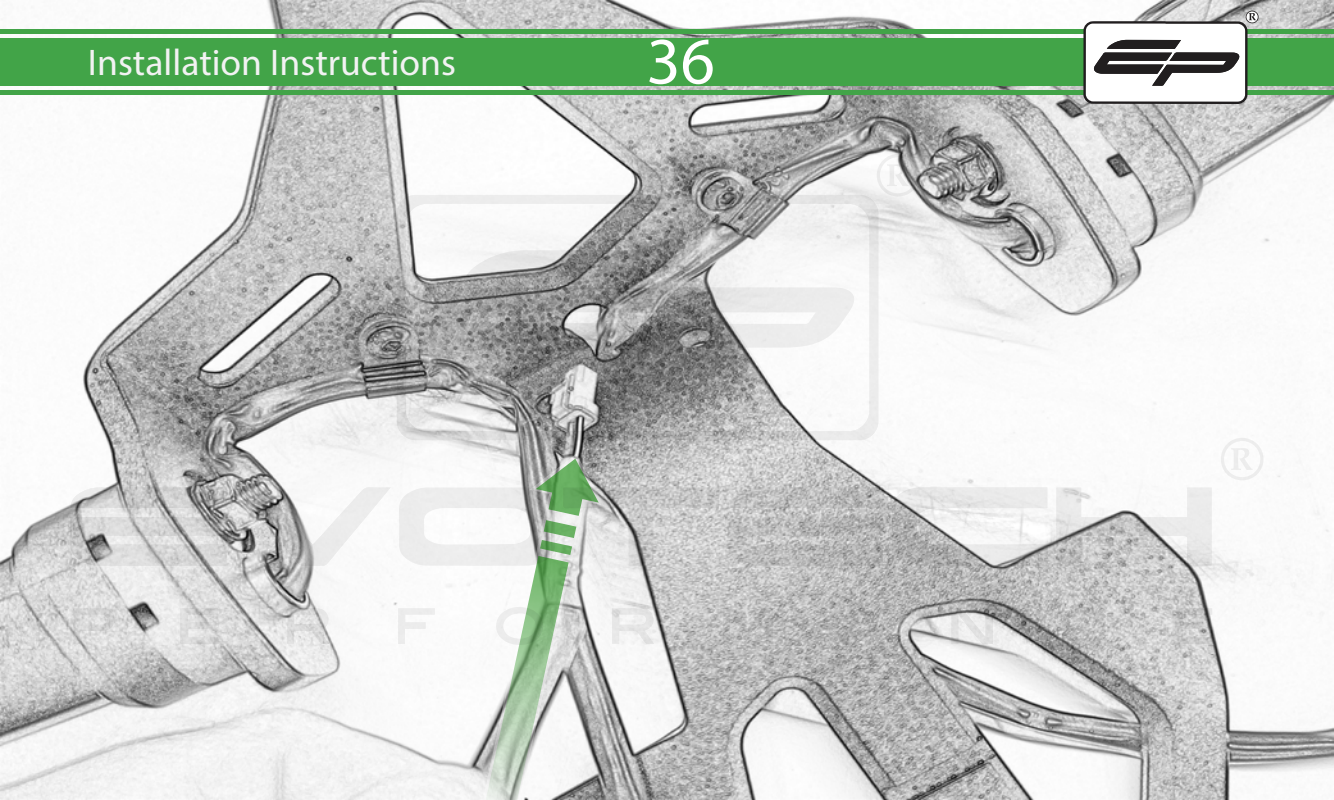



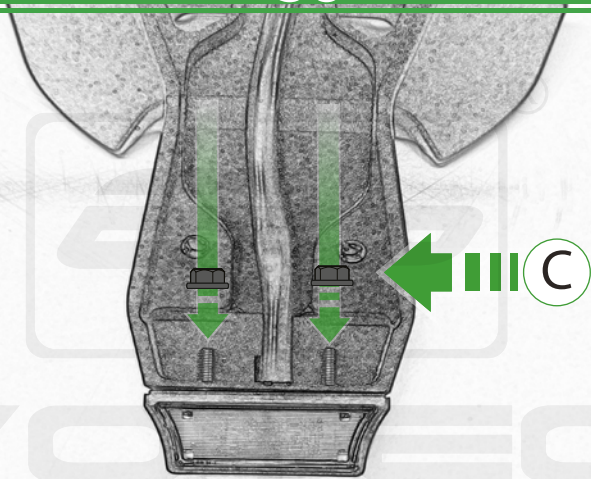

EVO TECH<sup>®</sup>  
P E R F O R M A N C E



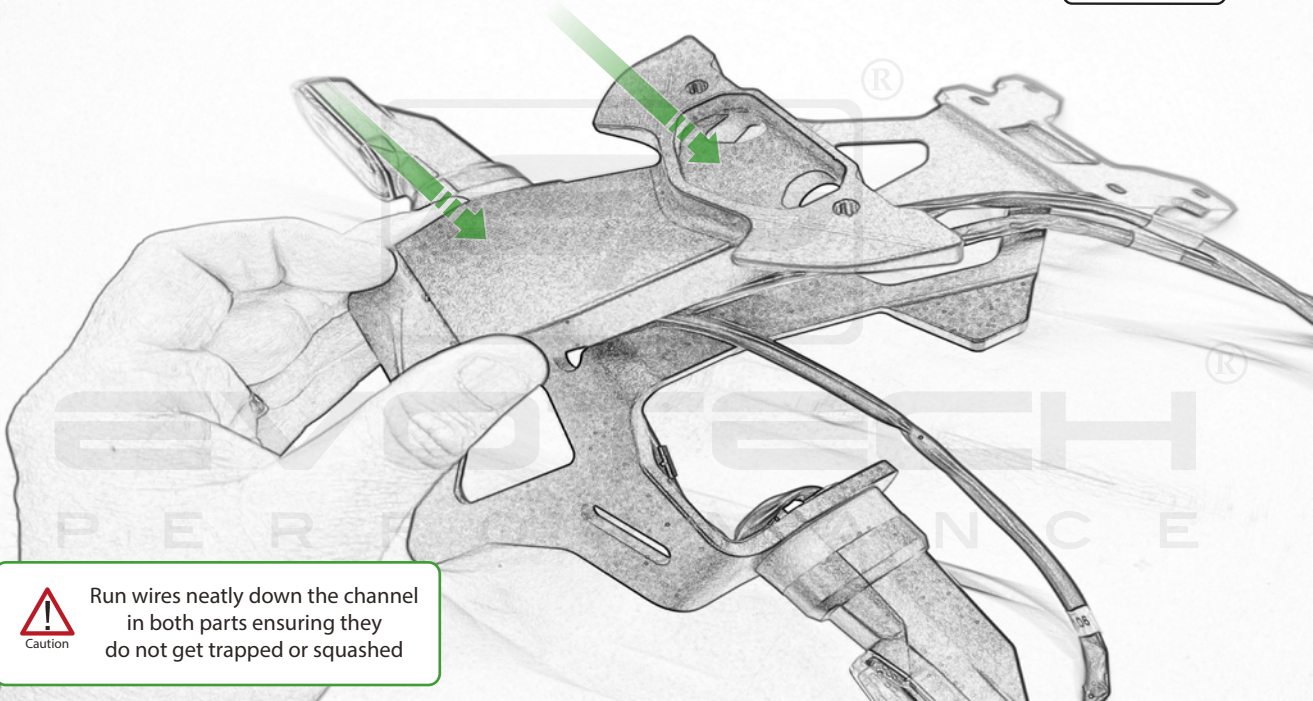

Caution

Run wires neatly down the channel in both parts ensuring they do not get trapped or squashed

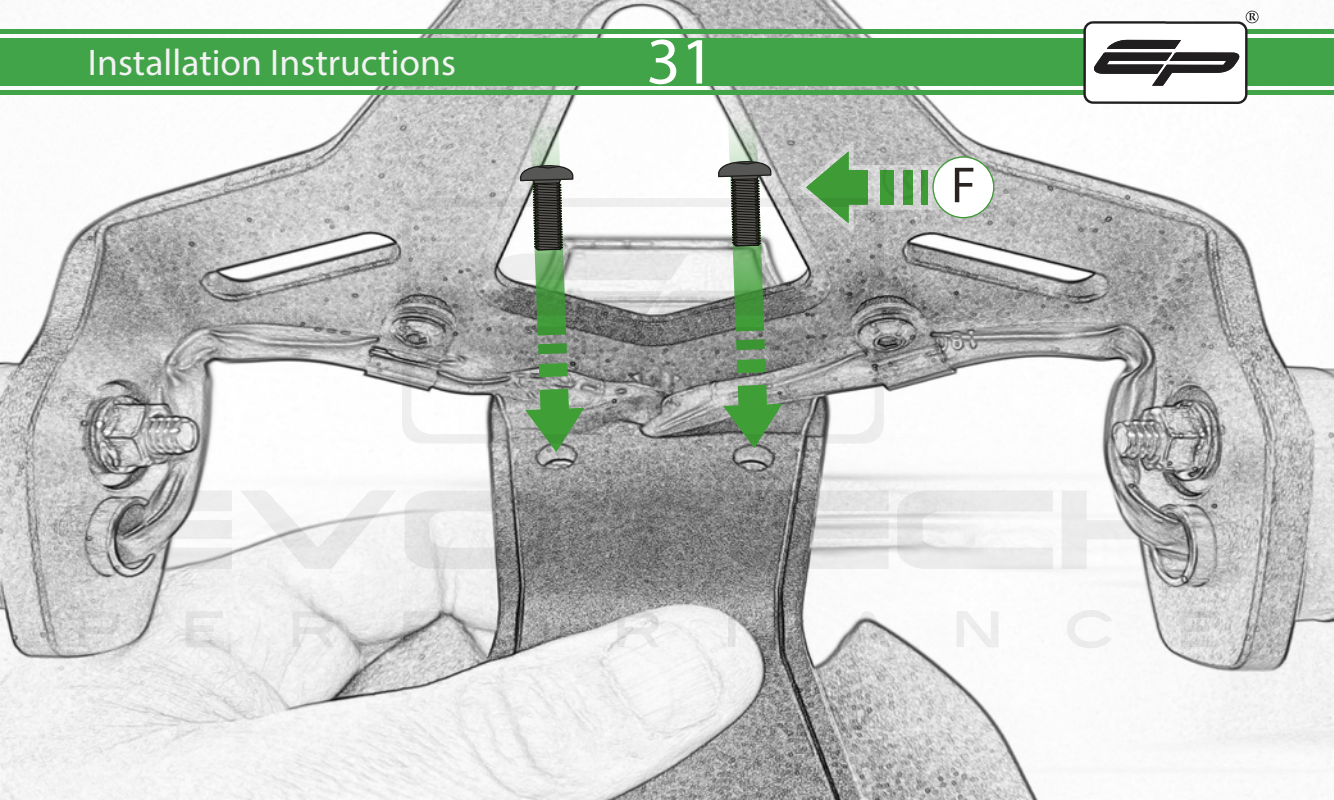

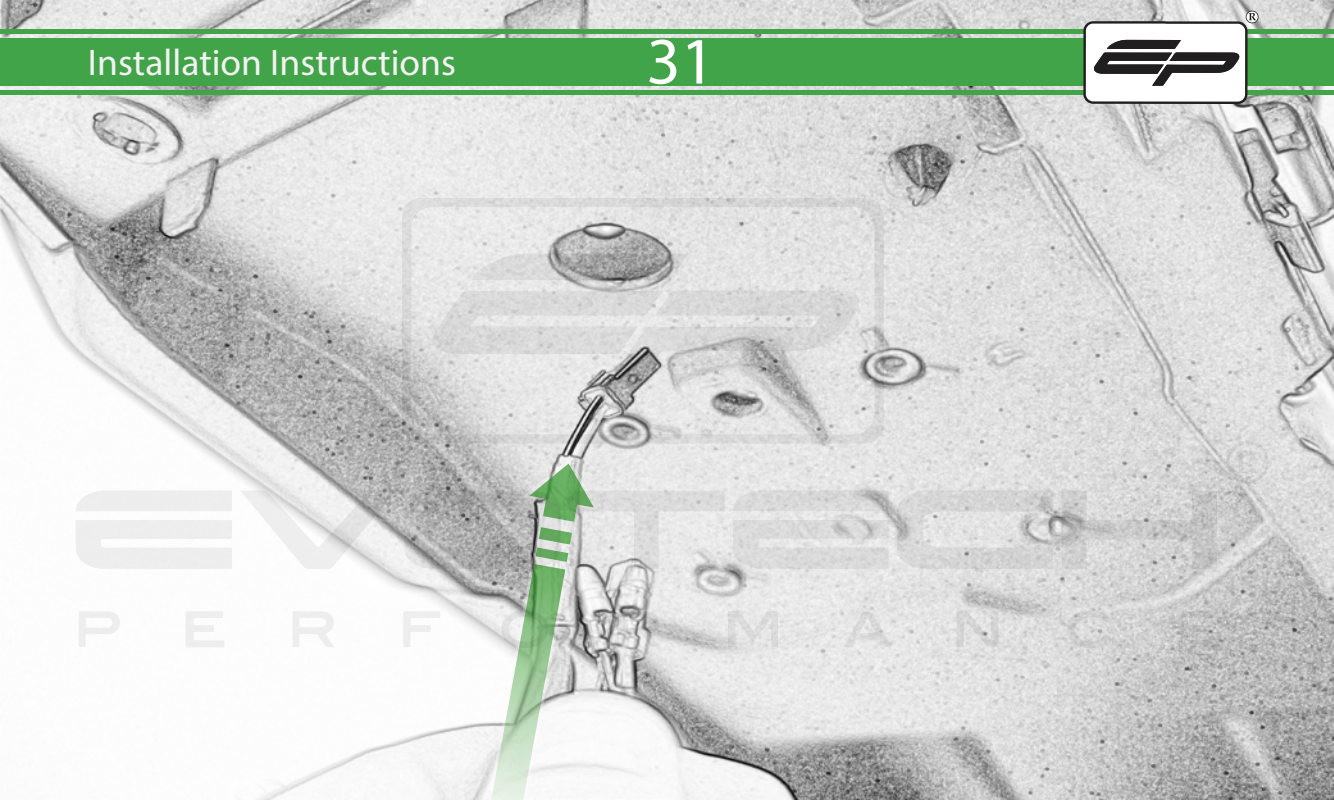

EV  
PERFORMANCE

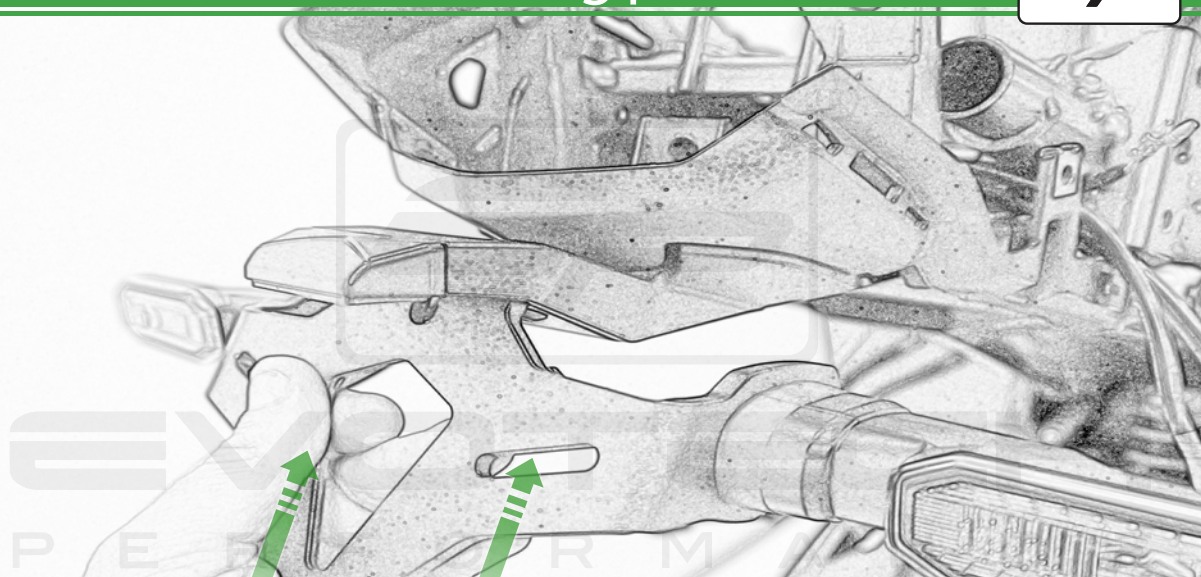

PERFORM



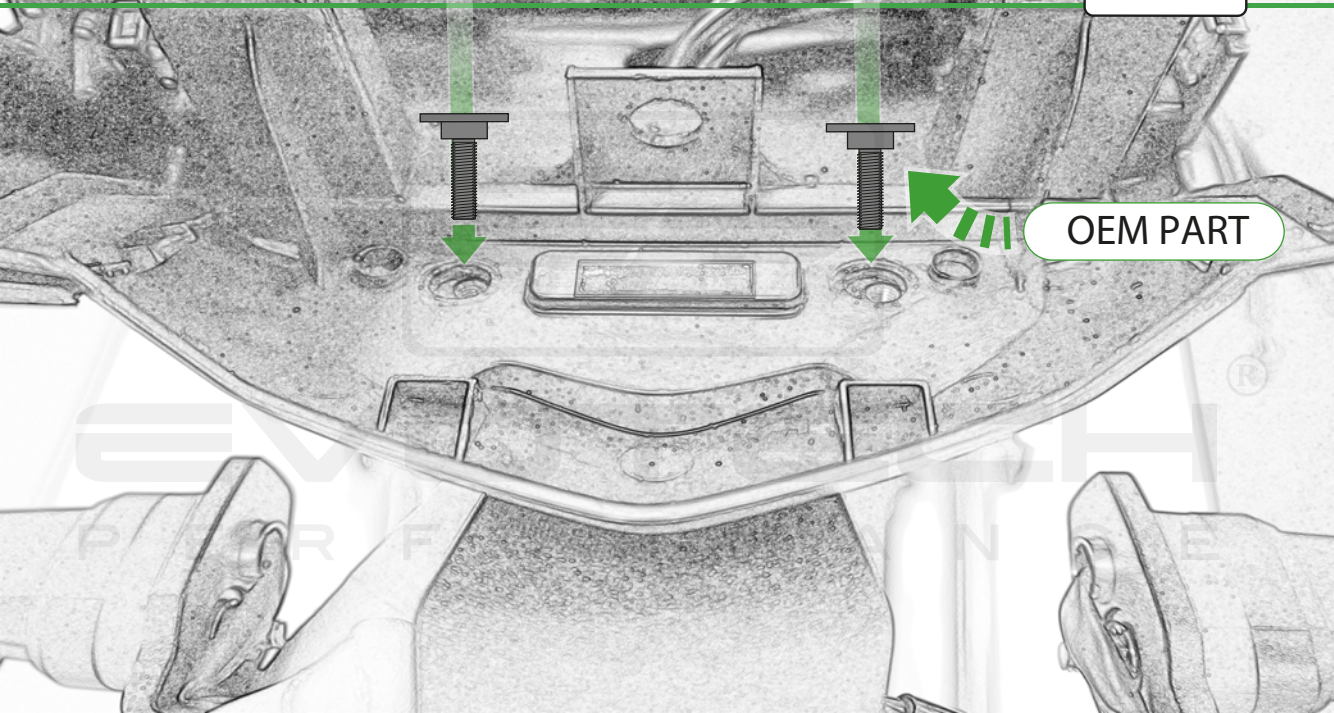

OEM PART

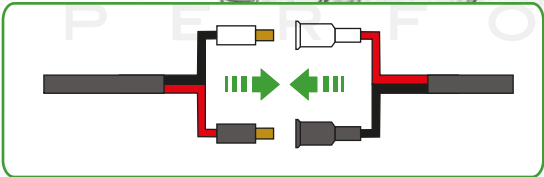
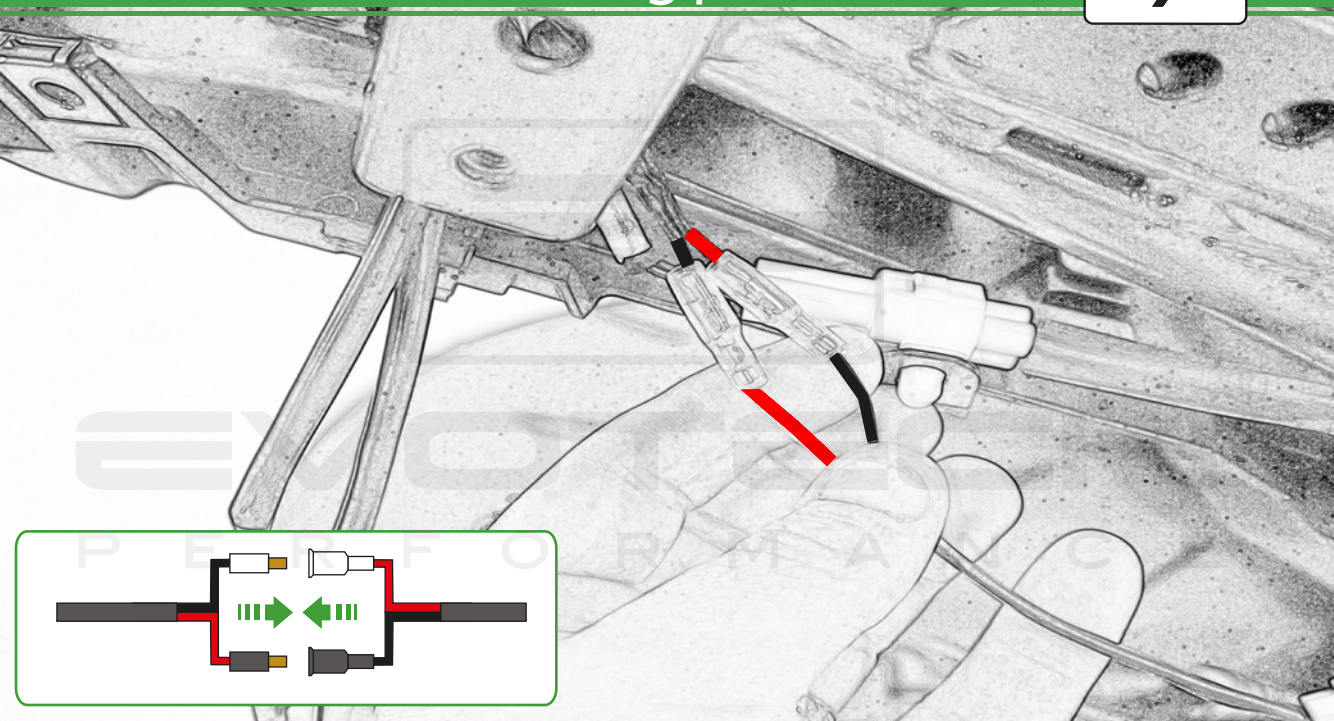









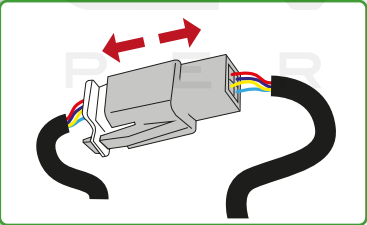
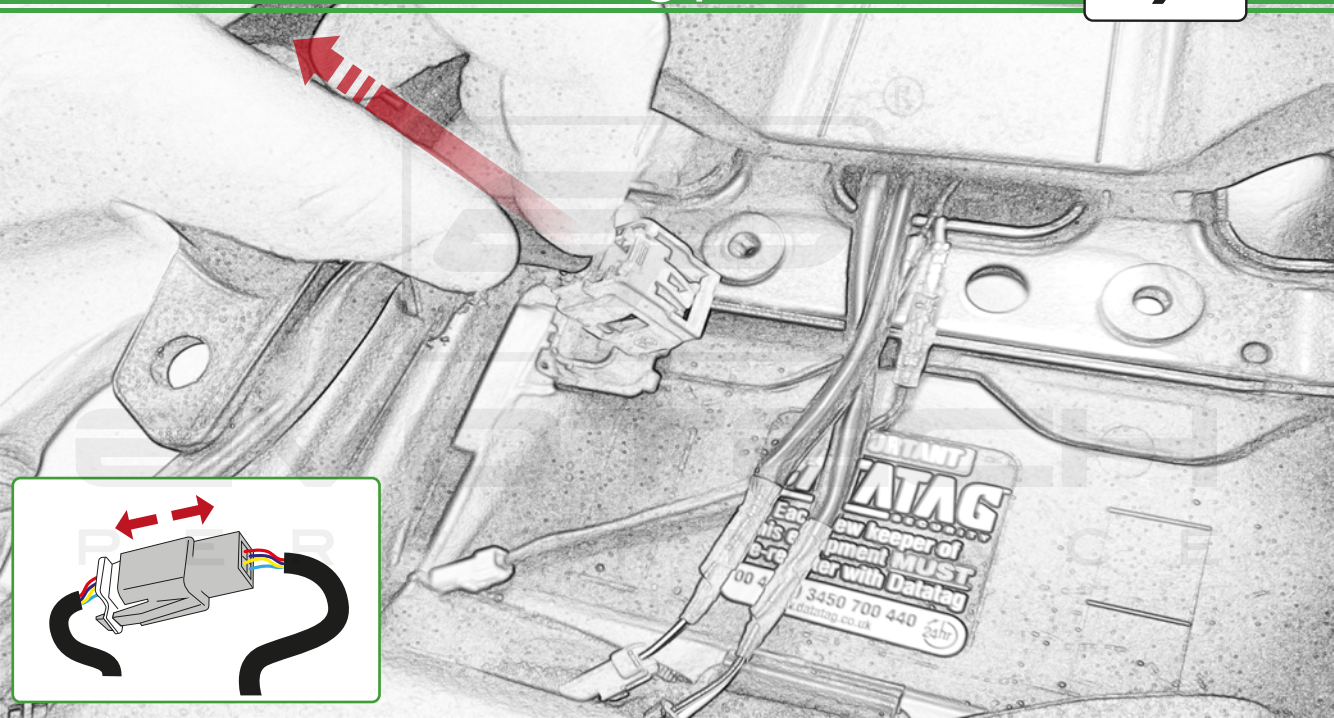

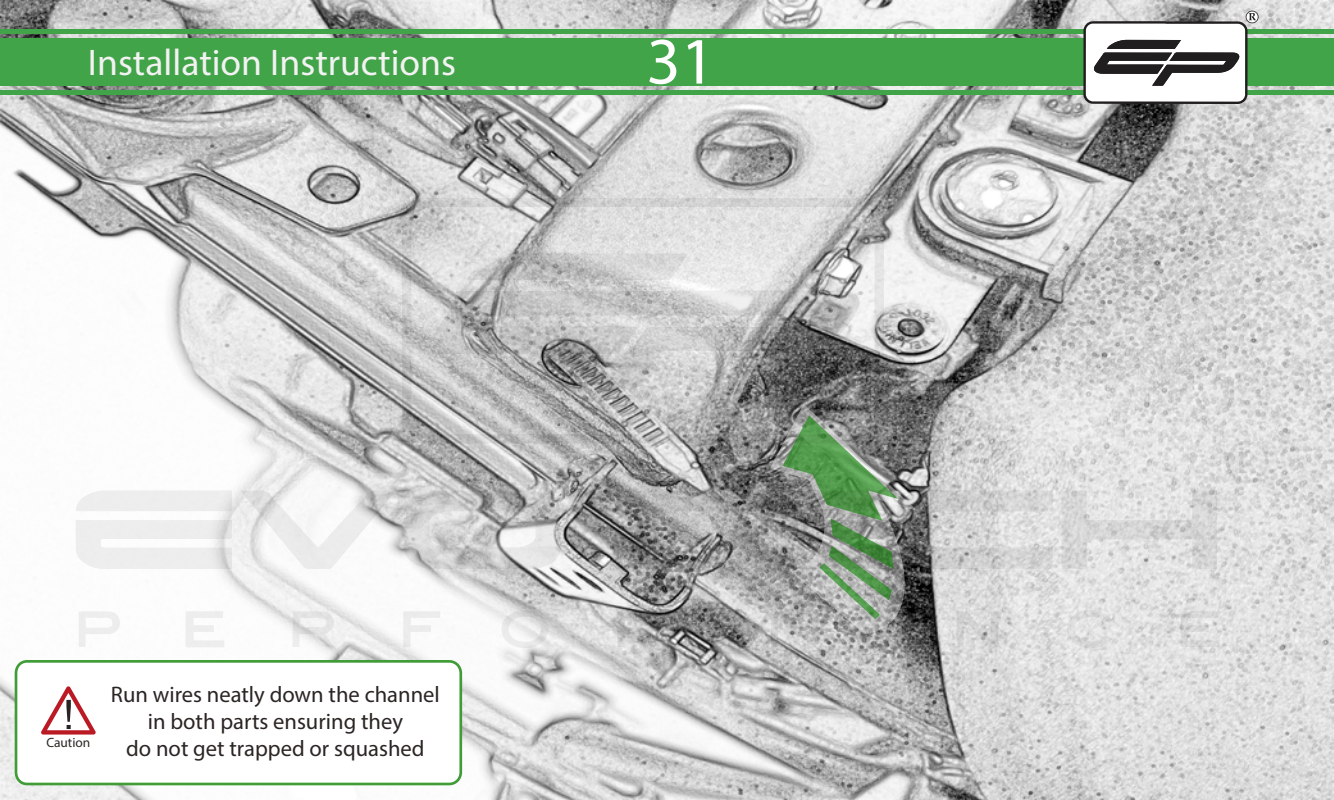

Caution

Run wires neatly down the channel in both parts ensuring they do not get trapped or squashed

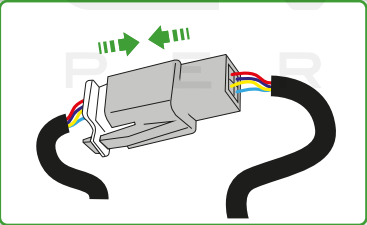
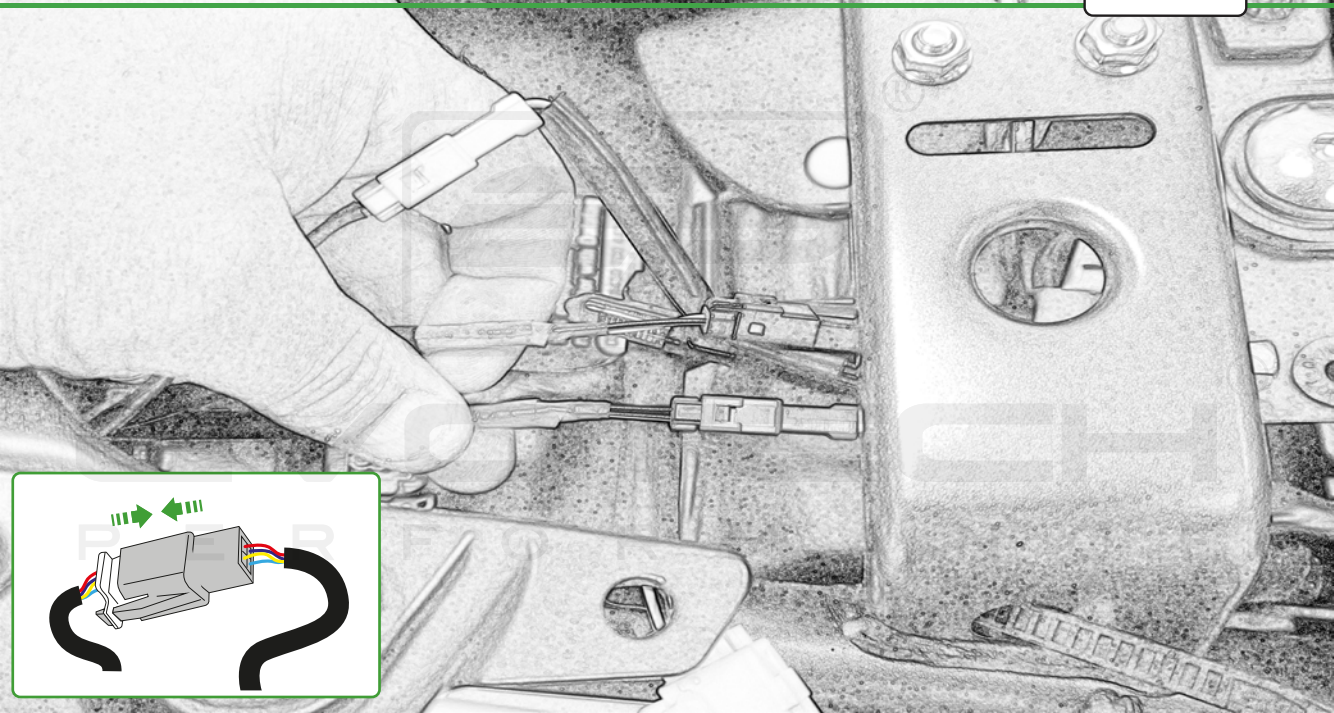



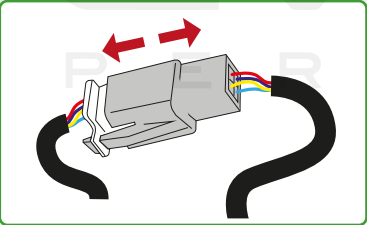
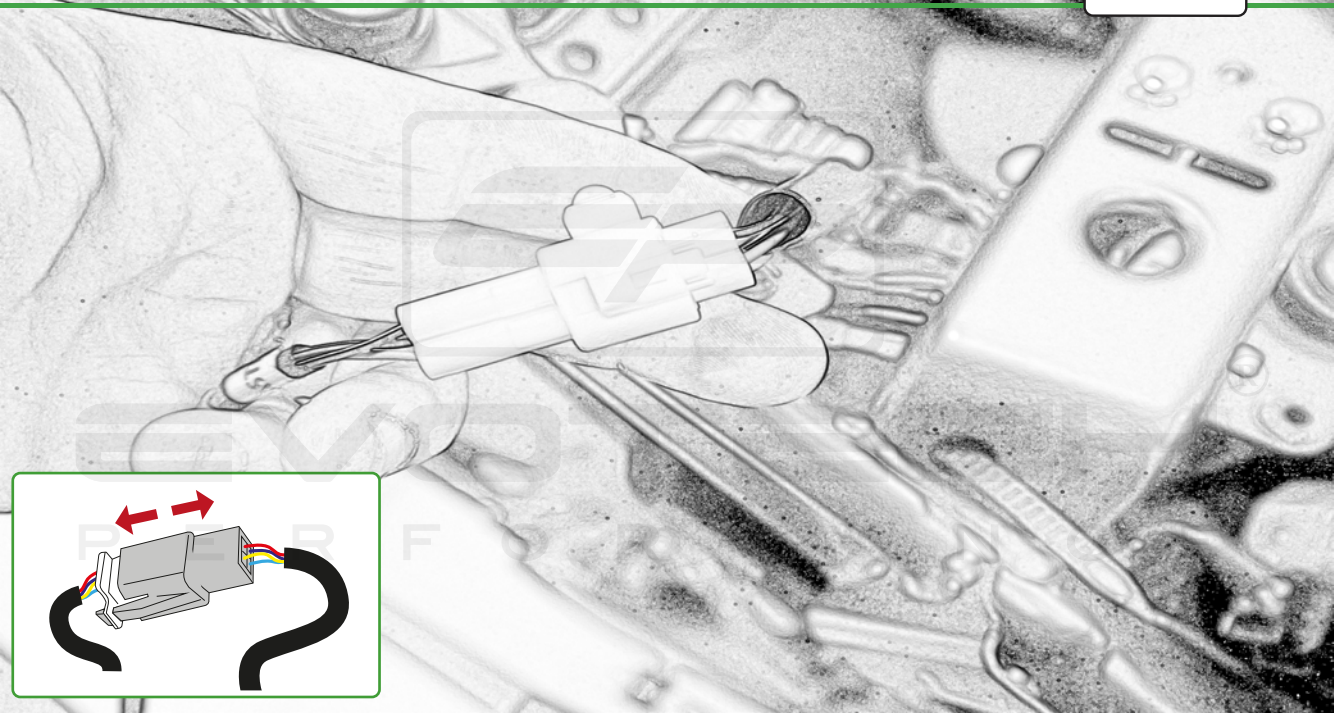



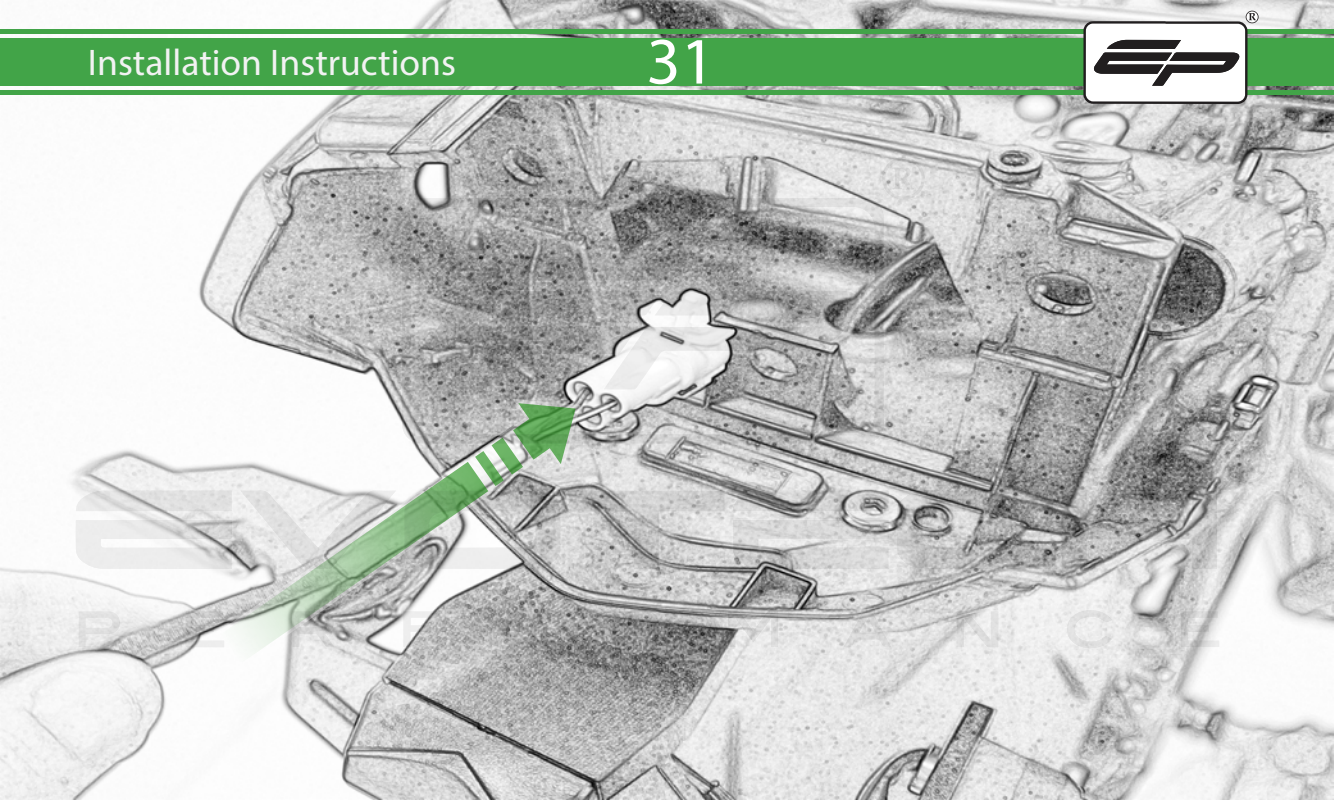



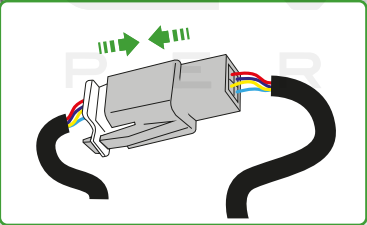
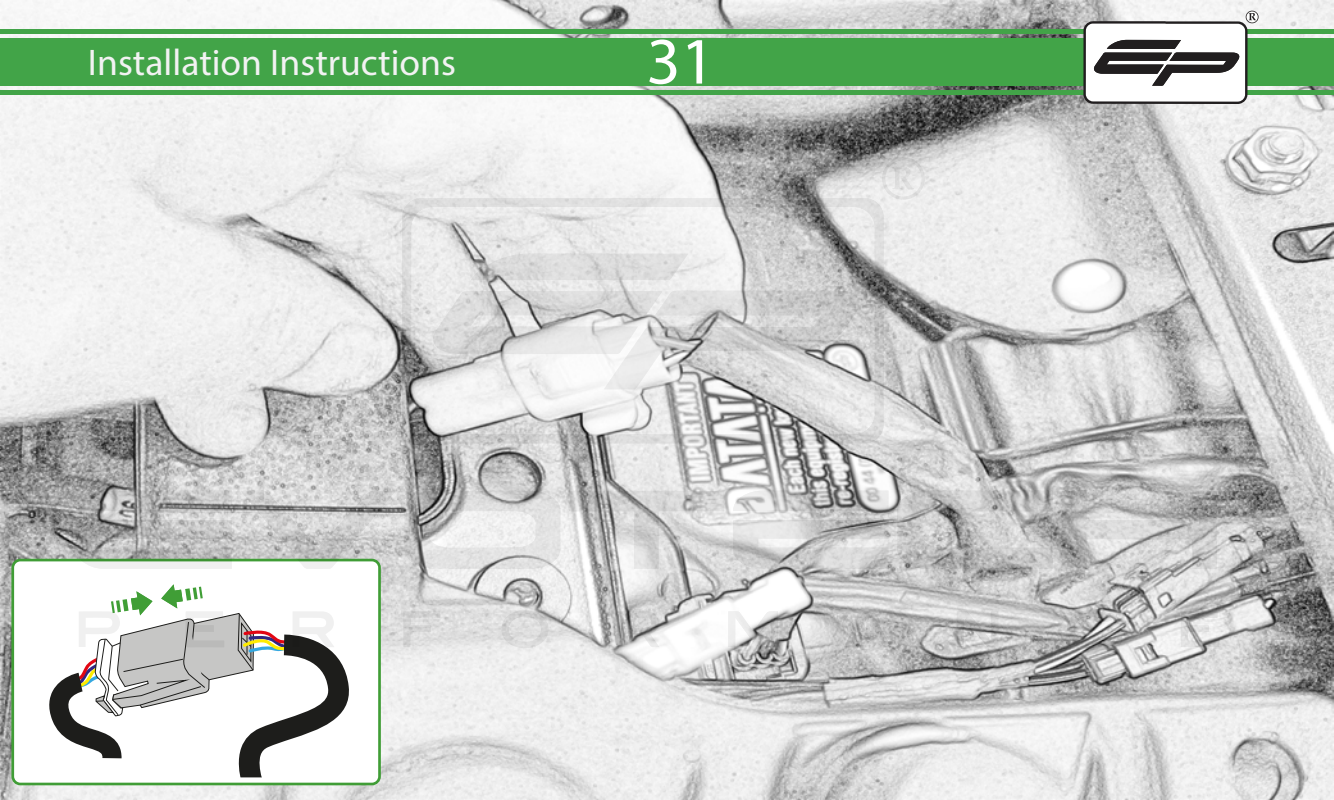



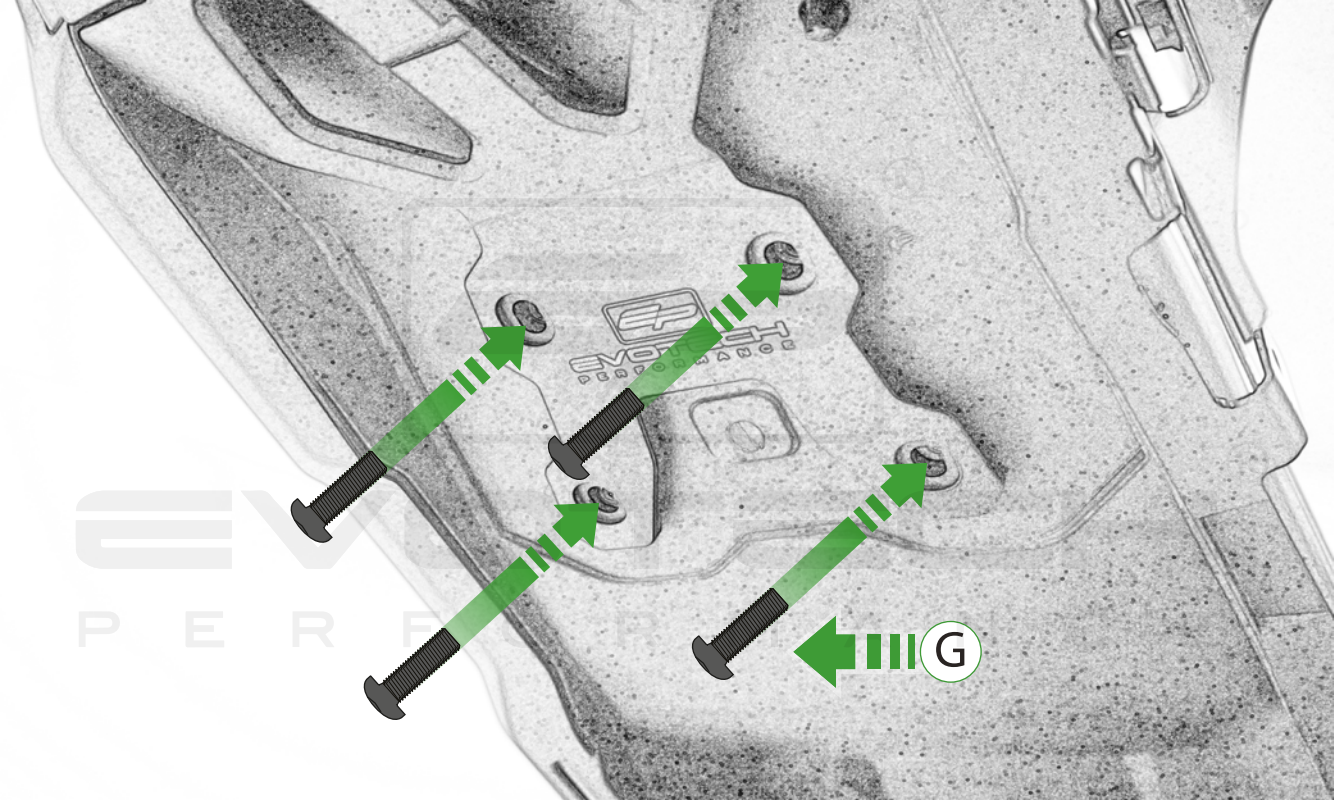

EP  
EVOLUTION  
PERFORMANCE

G

EVOLUTION  
PERFORMANCE





EVOTECH<sup>®</sup>

P E R F O R M A N C E

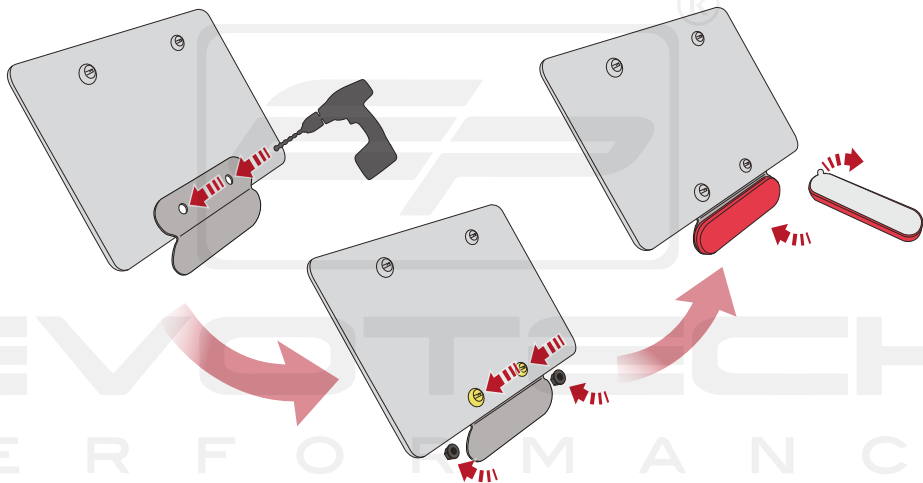

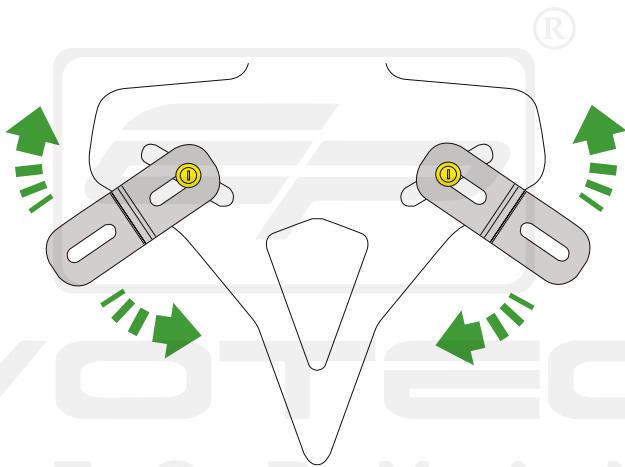

EVOTECH<sup>®</sup>  
P E R F O R M A N C E



## **ESSENTIAL CHECKS**



After installation of your tail tidy ensure that the licence plate does not contact the rear tyre when suspension is fully compressed.

Ensure all electrics including indicators, tail light, brake light and licence plate light lights are working correctly before riding the motorcycle.

It is recommended that periodic inspections are made to ensure that all fixings are fully tightend.





**EVOTECH**®  
P E R F O R M A N C E

[www.evotech-performance.com](http://www.evotech-performance.com)