

EVOTECH®
P E R F O R M A N C E

www.evotech-performance.com

Honda CB650 Neo / CBR650R

Tail Tidy Instructions



Kit Contents PRN015287

- (A) 1 x Tail Tidy Bracket
- (B) 1 x Number Plate light
- (C) 1 x Light Mount
- (D) 1 x Loom Connector Type 7
- (E) 2 x M5 x 25mm Black Button Head Bolts
- (F) 2 x M4 Flange Nuts
- (G) 2 x M4 x 12mm Black Button Head Bolts
- (H) 4 x M4 x 6mm Black Button Head Bolts
- (I) 4 x P-clips No4







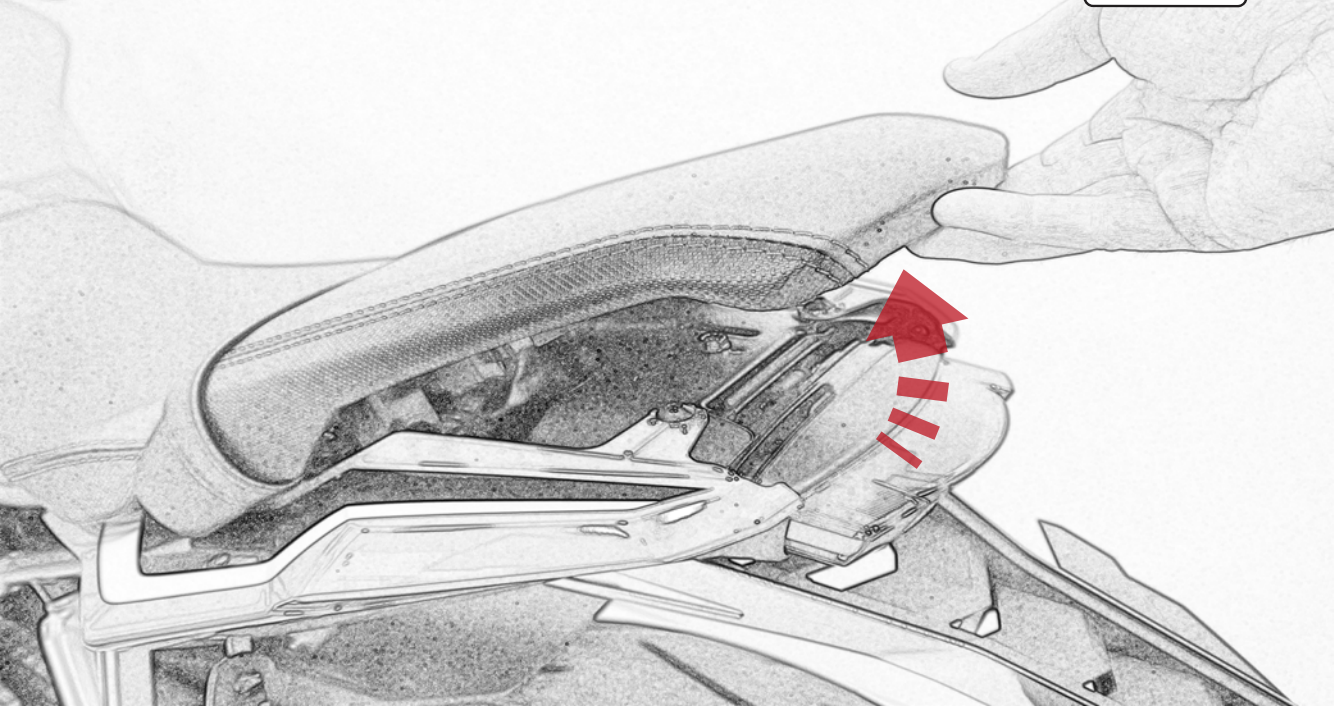

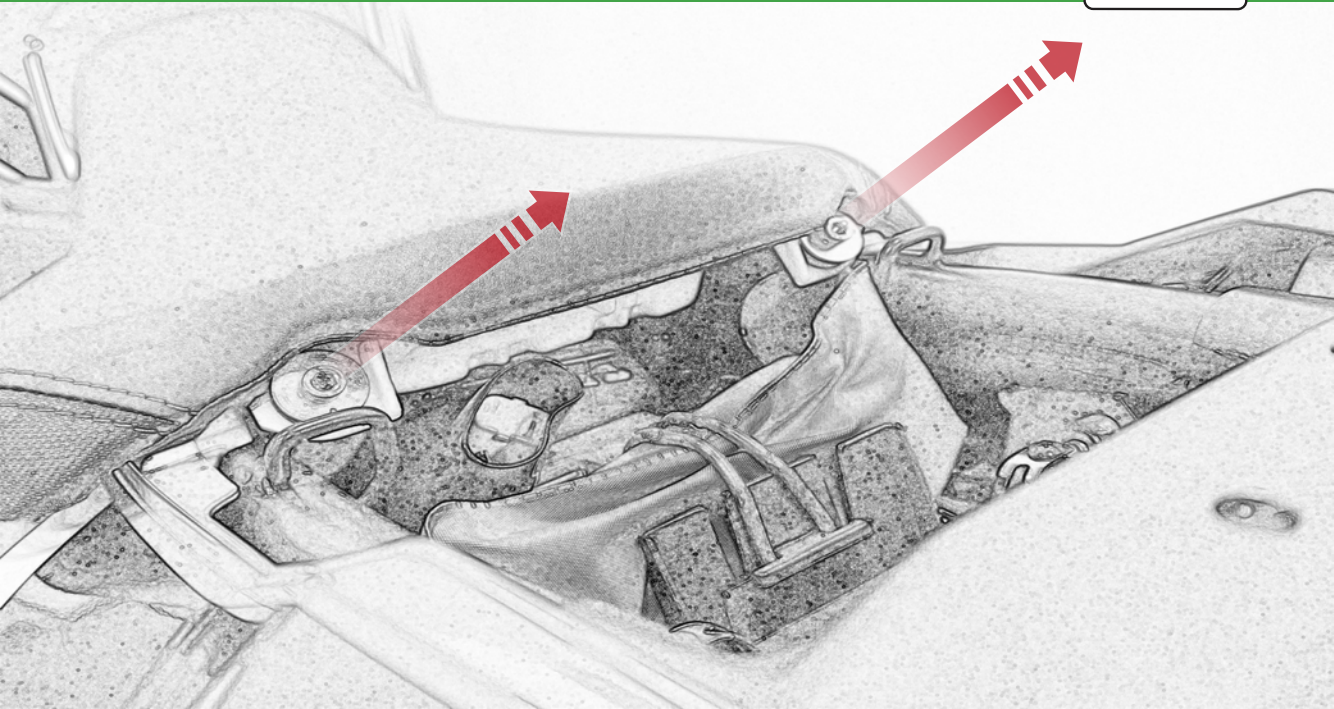

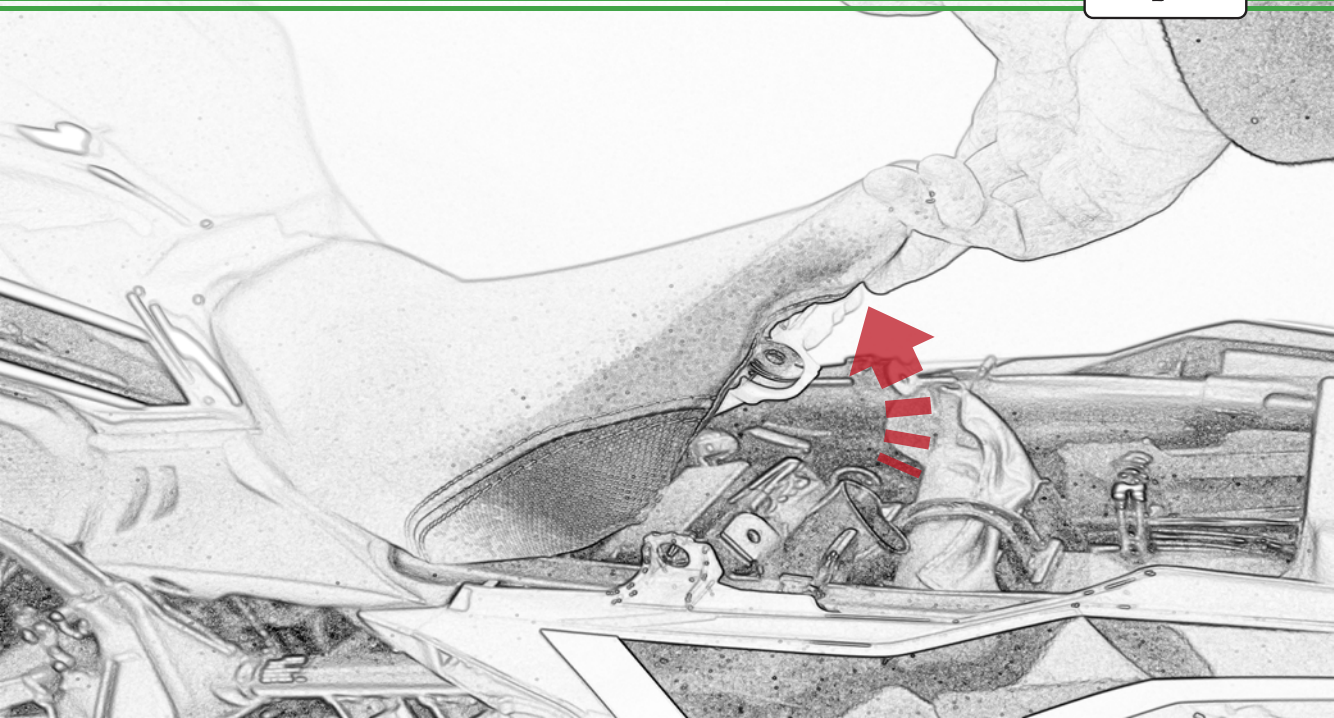

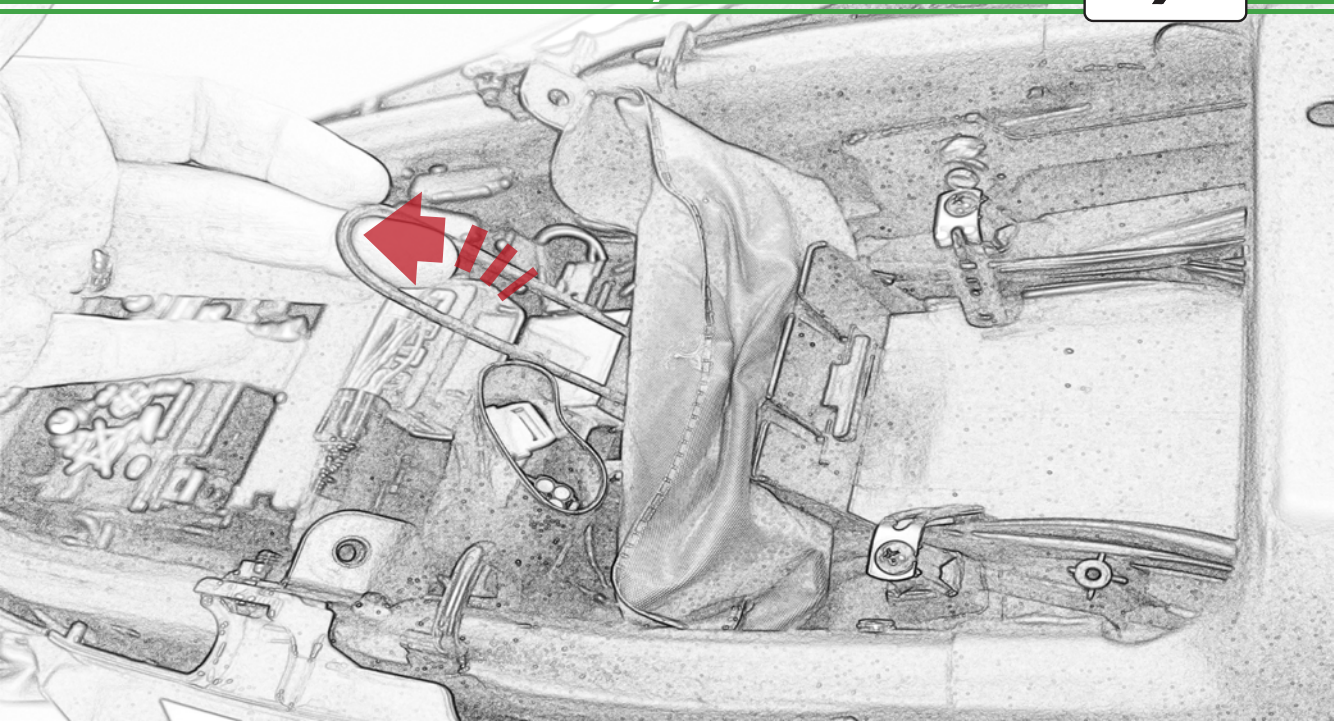

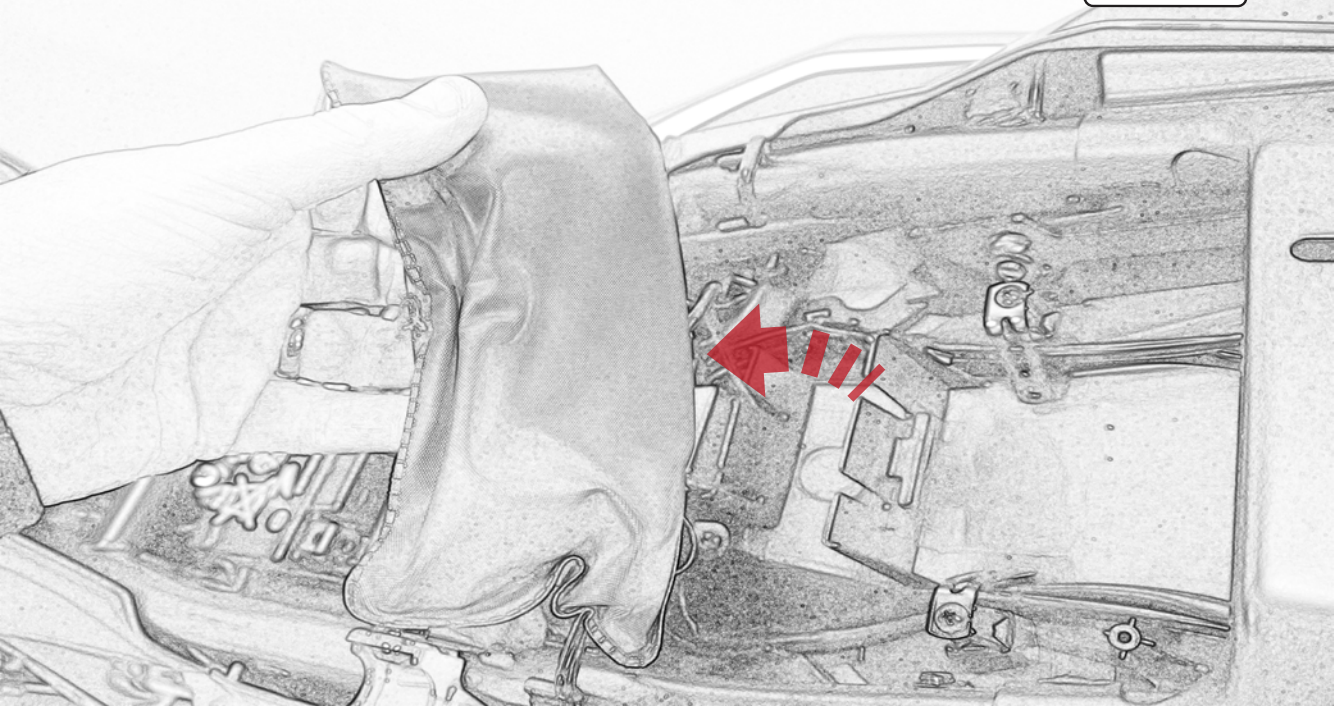

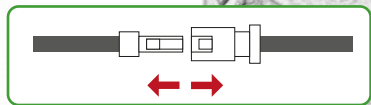
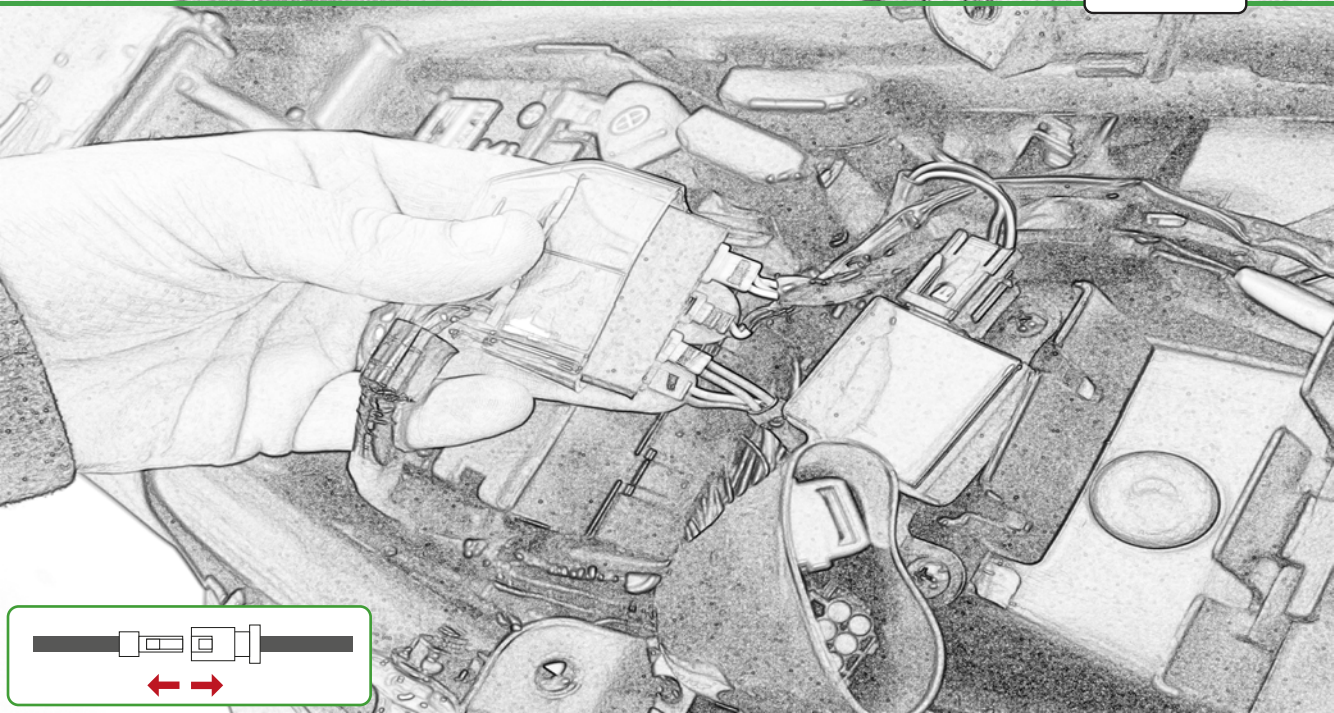

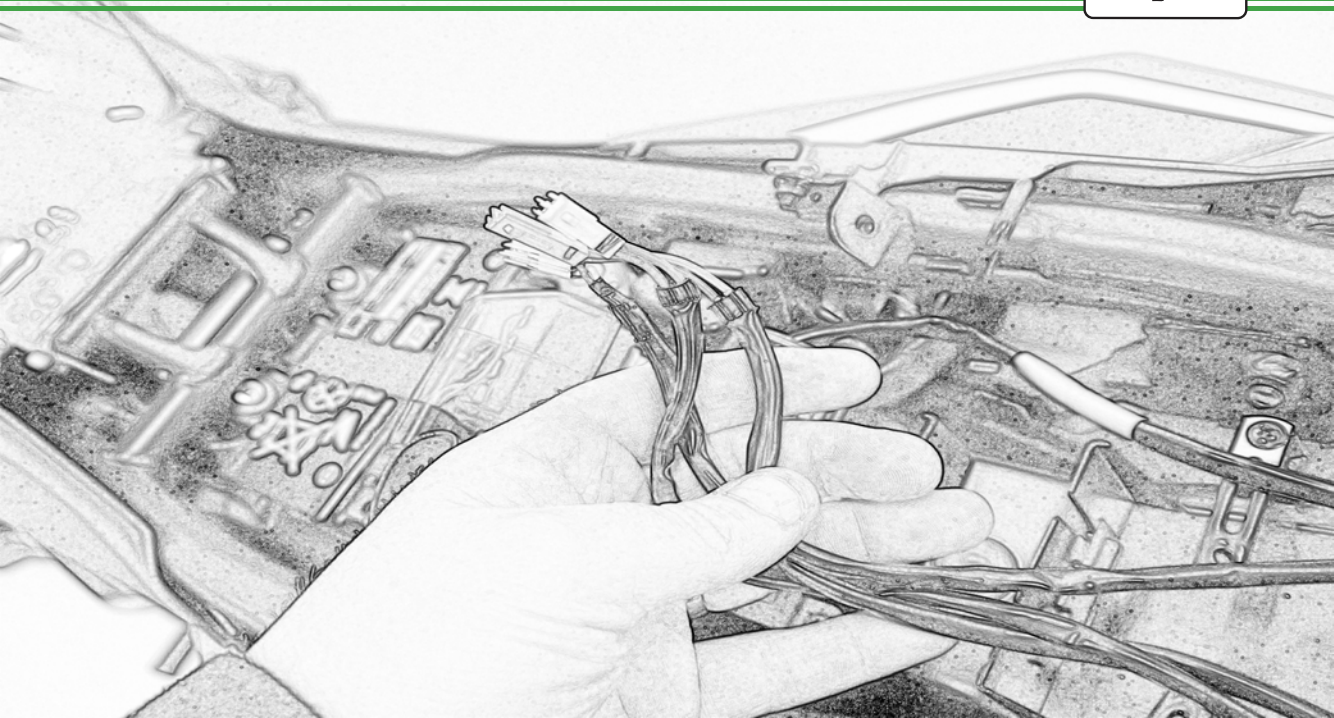

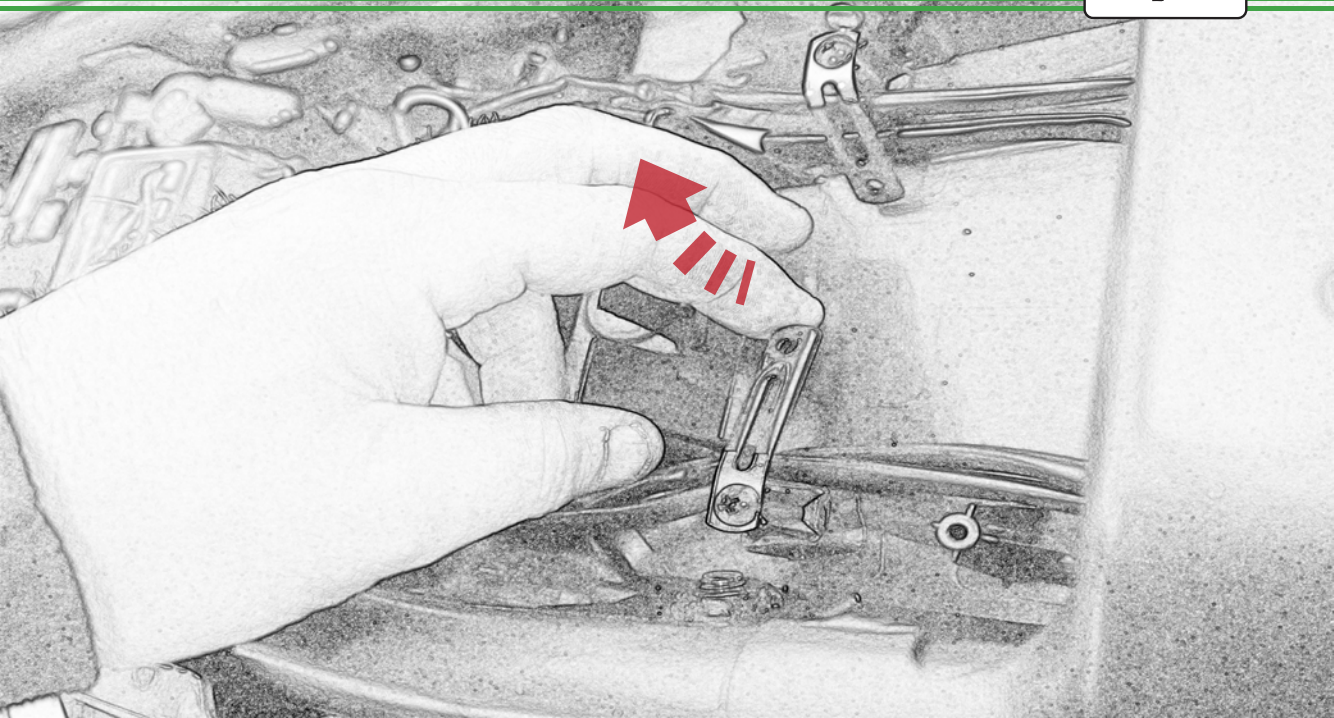

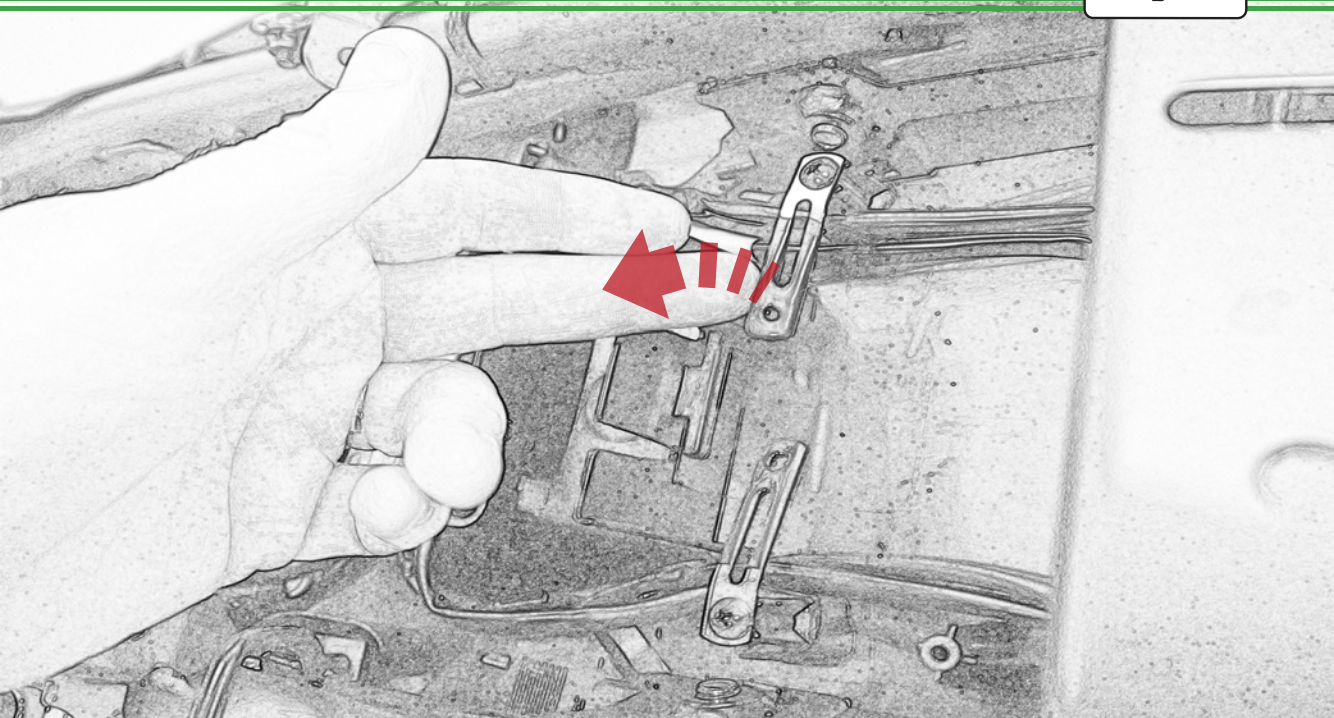

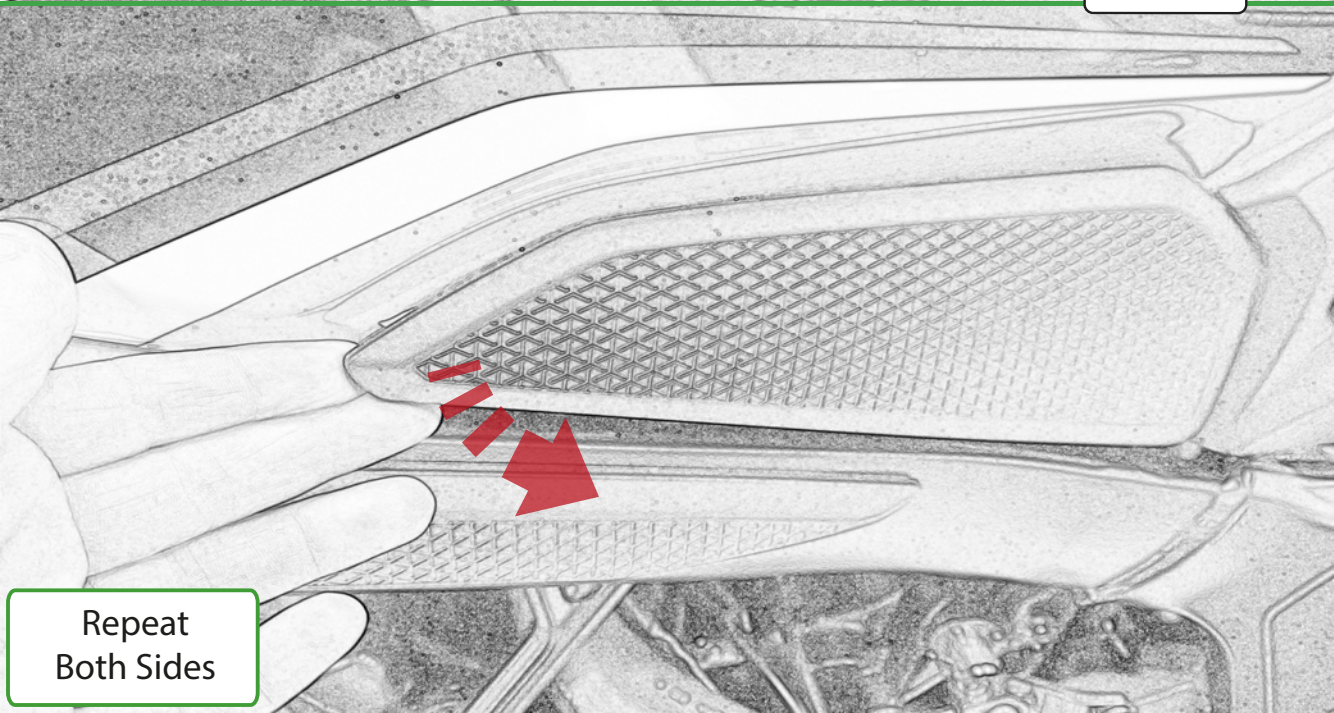

Repeat
Both Sides

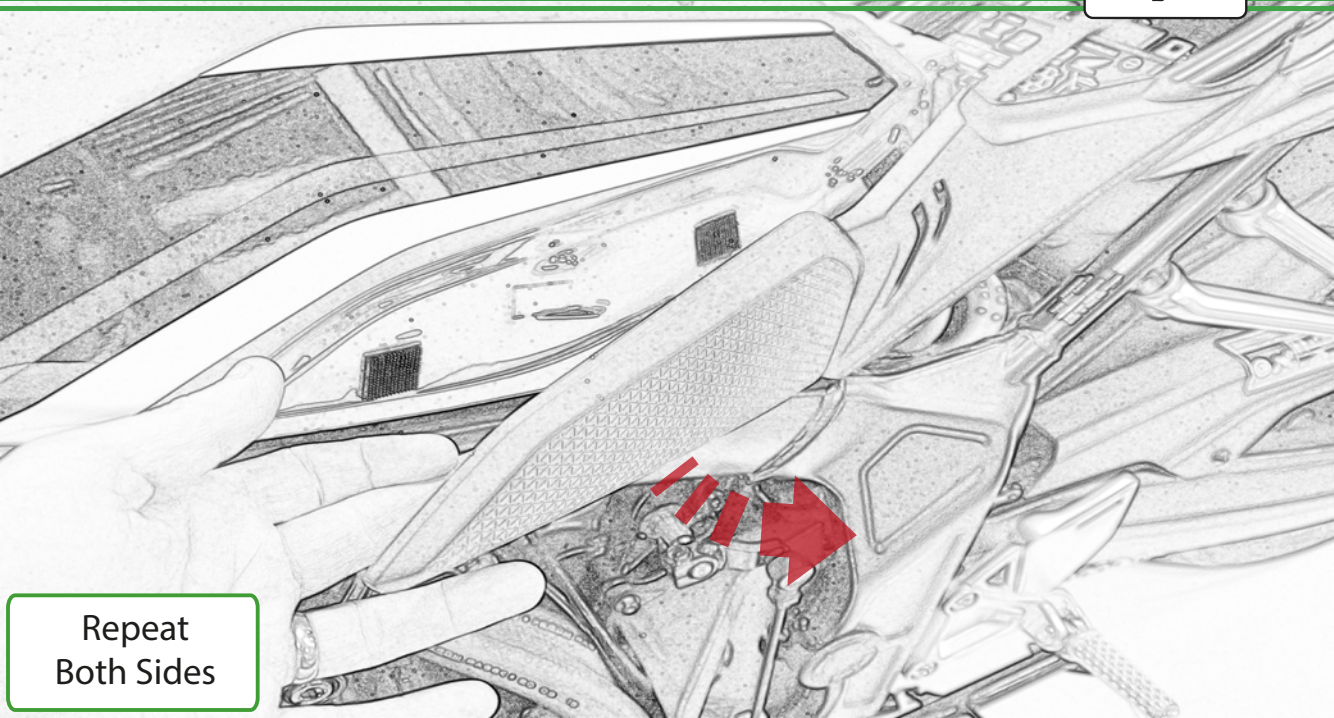

Repeat
Both Sides

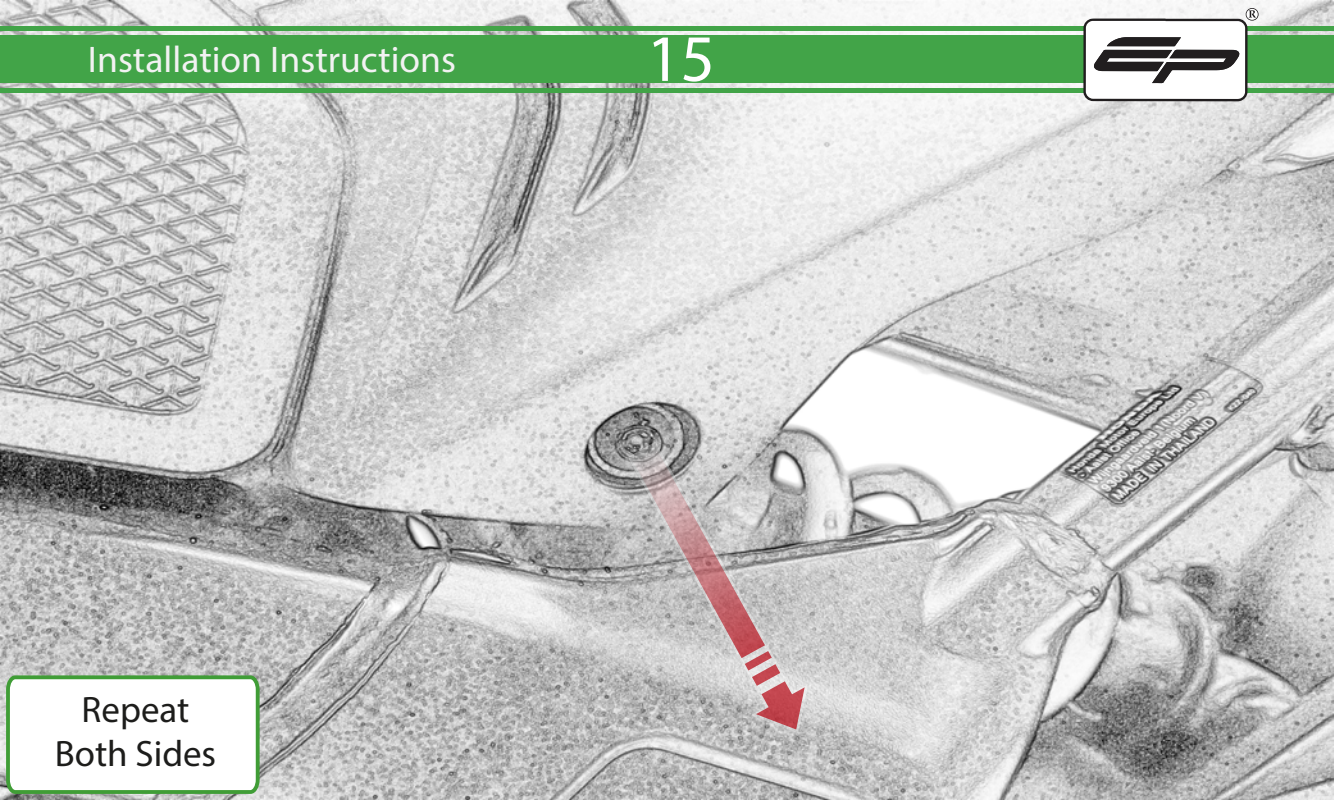

Repeat
Both Sides

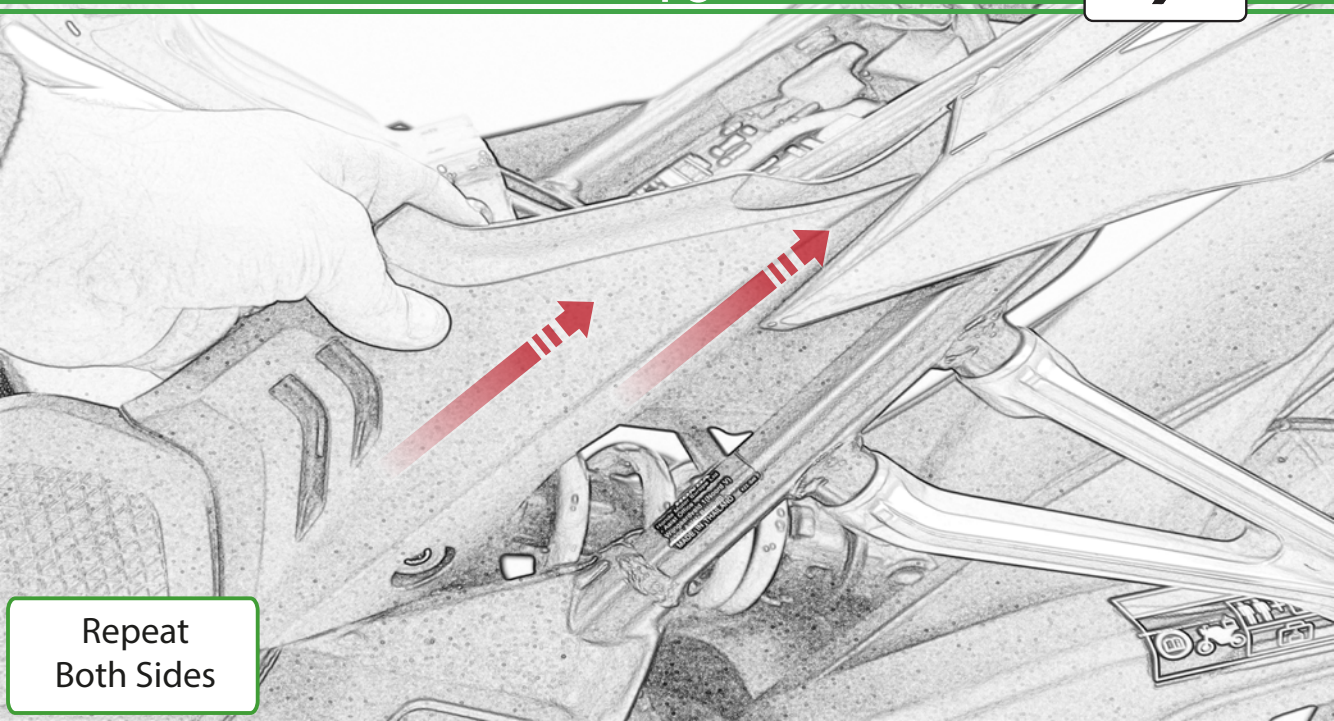

Repeat
Both Sides

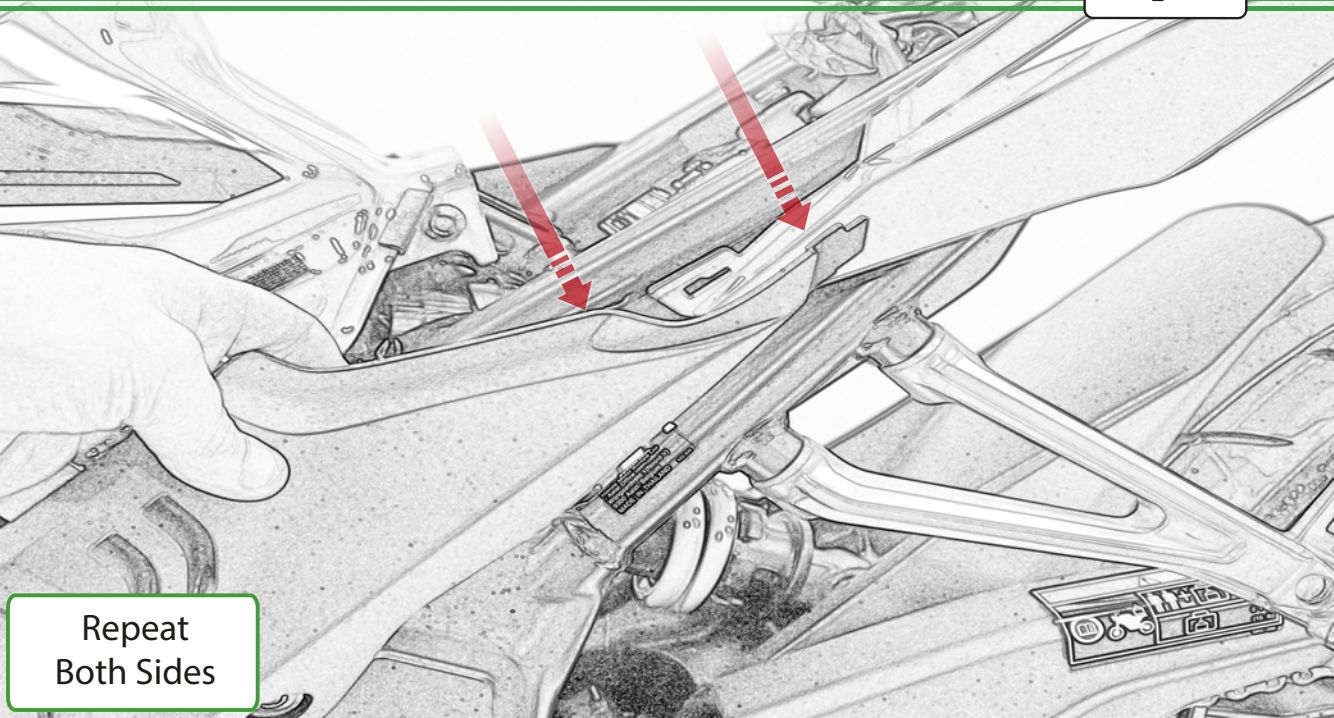

Repeat
Both Sides

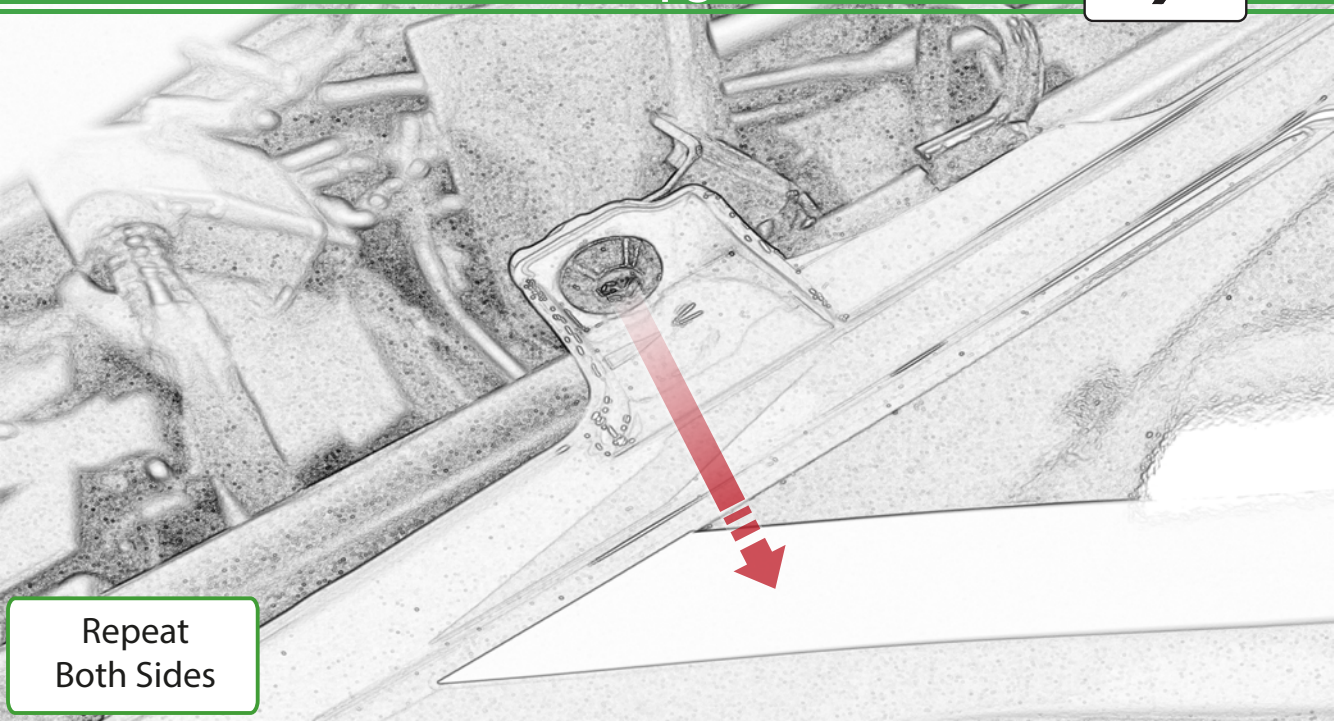

Repeat
Both Sides



Repeat
Both Sides

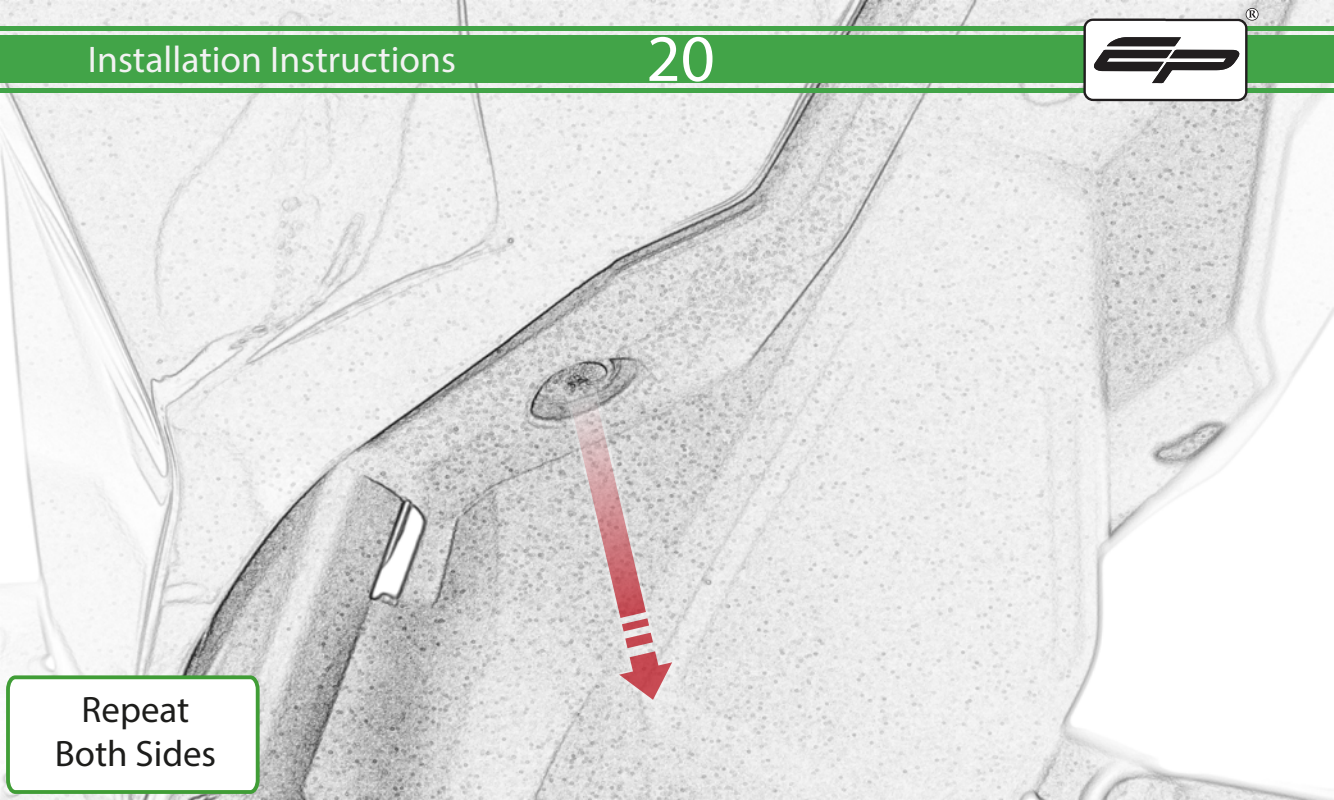

Repeat
Both Sides

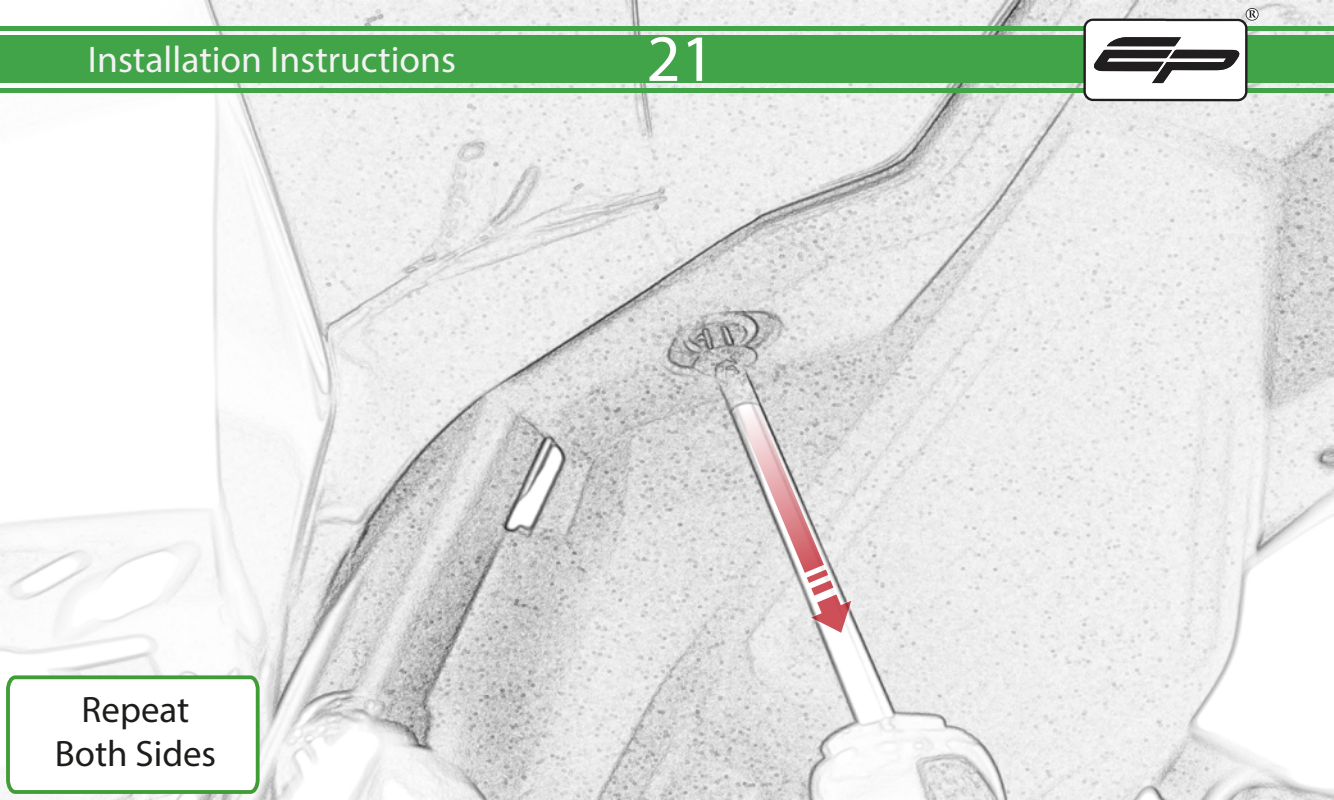

Repeat
Both Sides

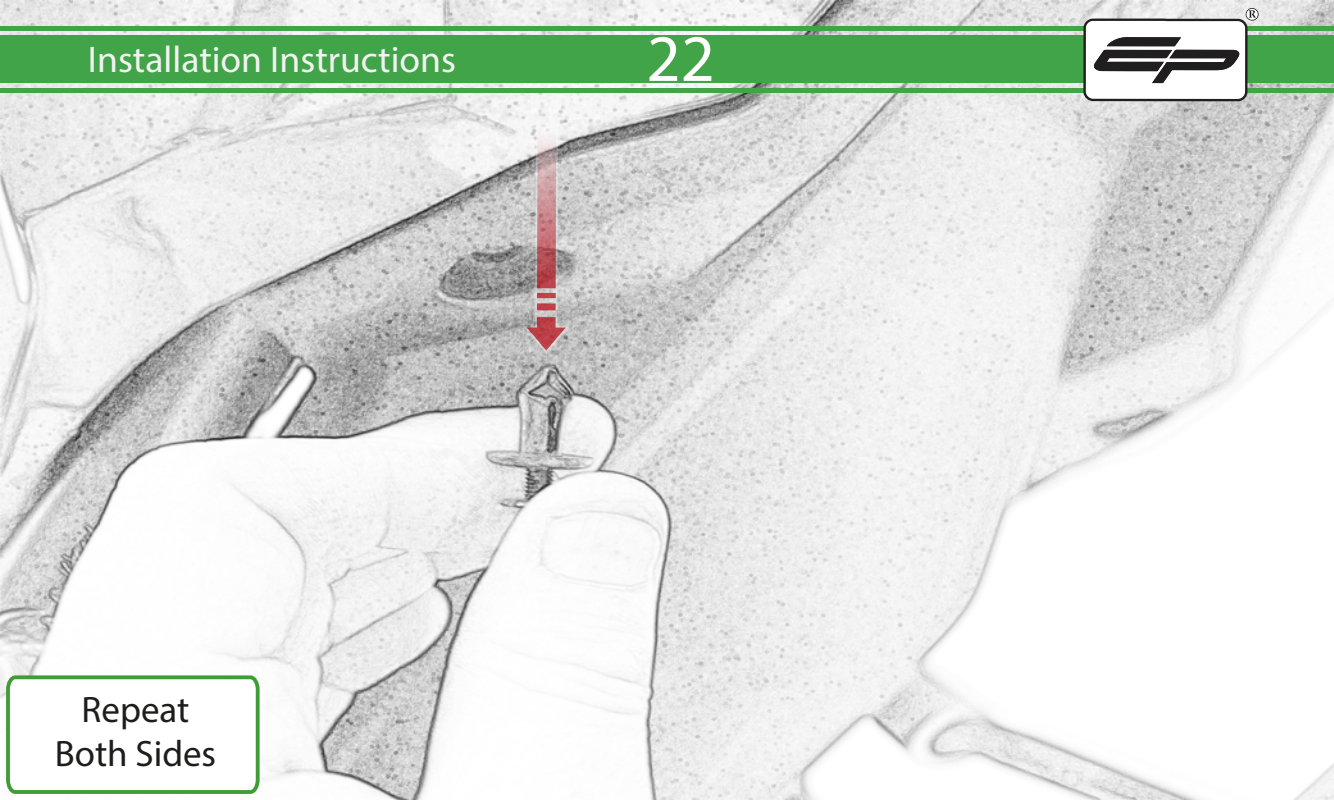

Repeat
Both Sides

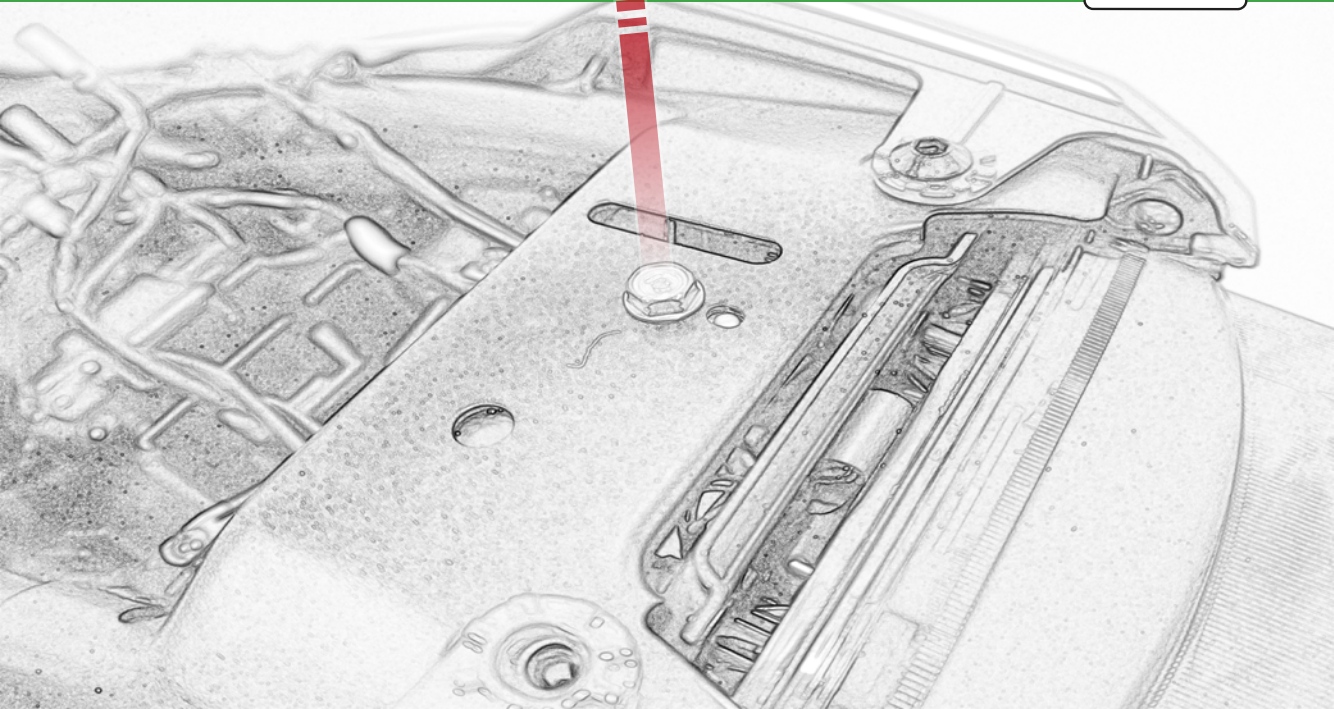

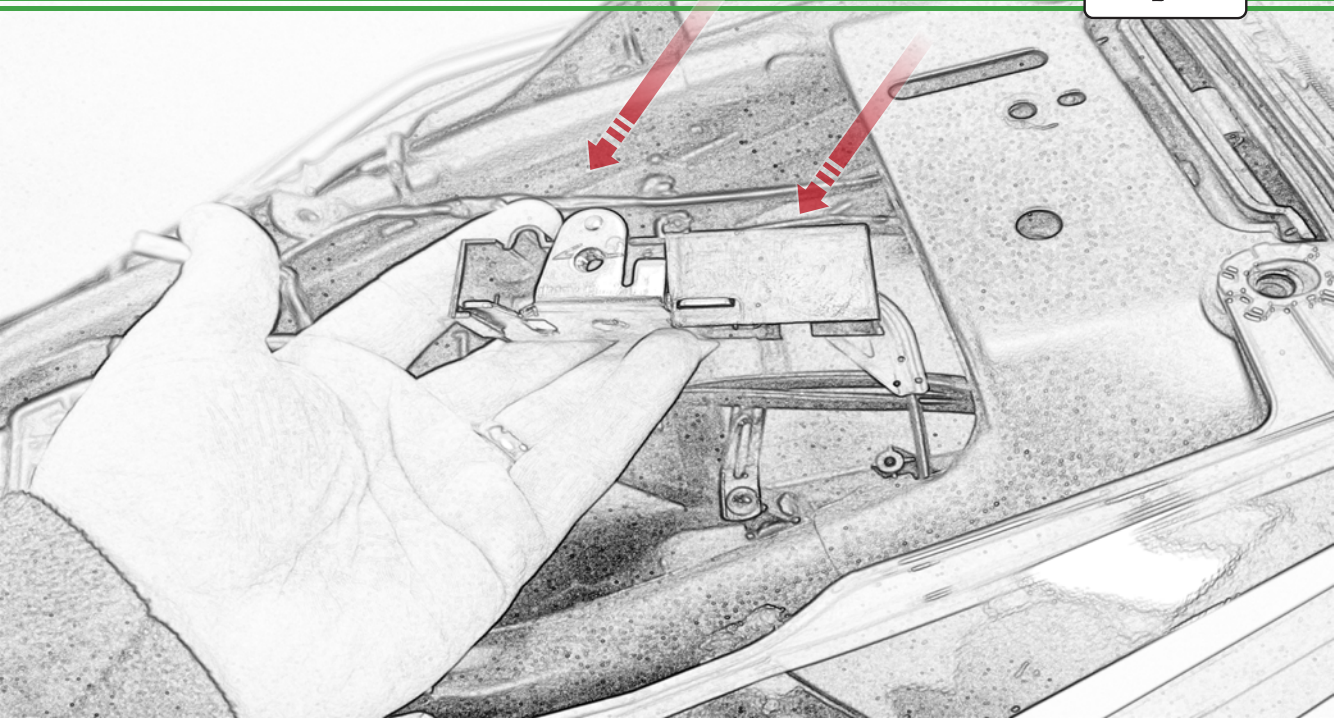

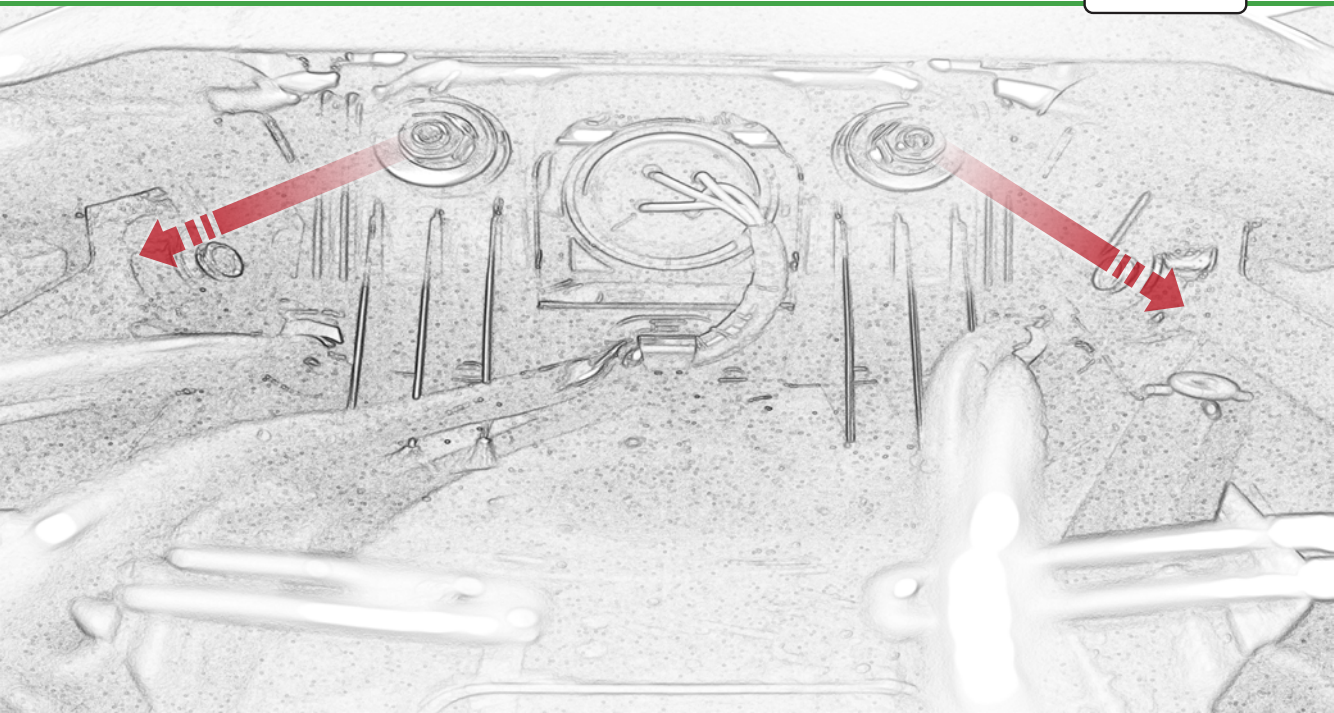

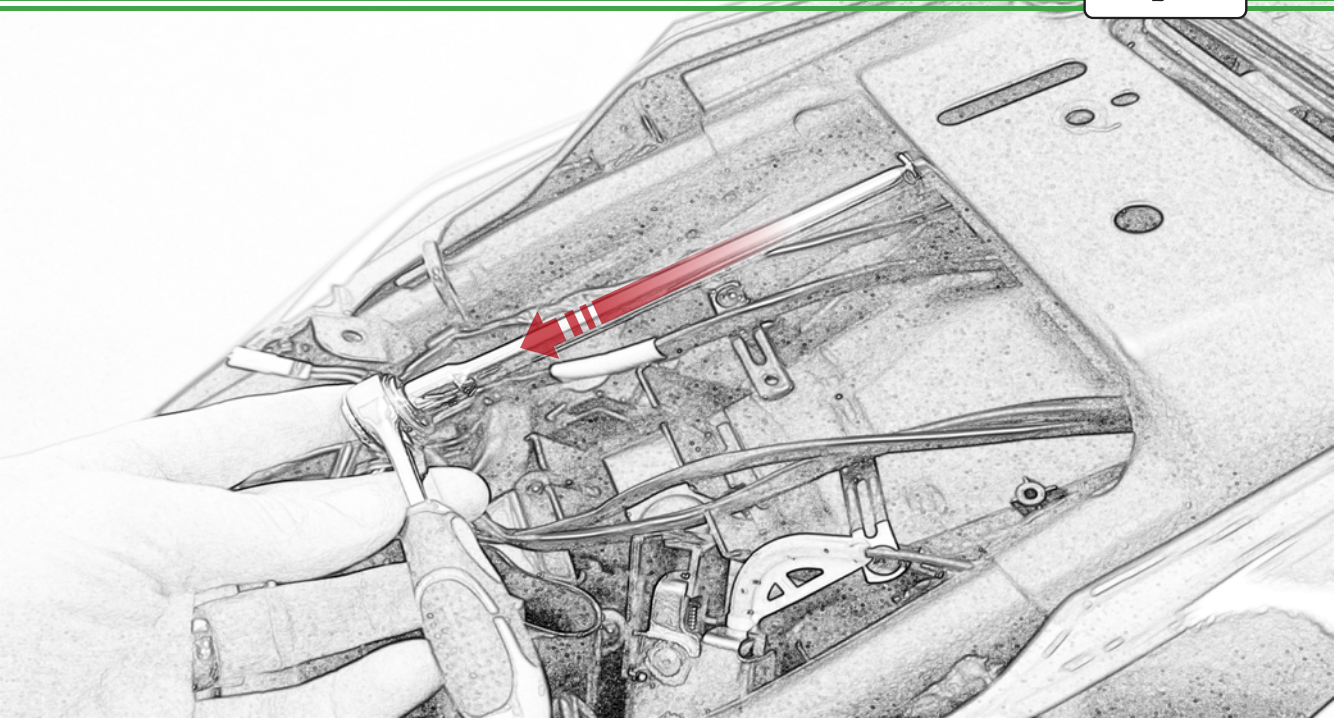



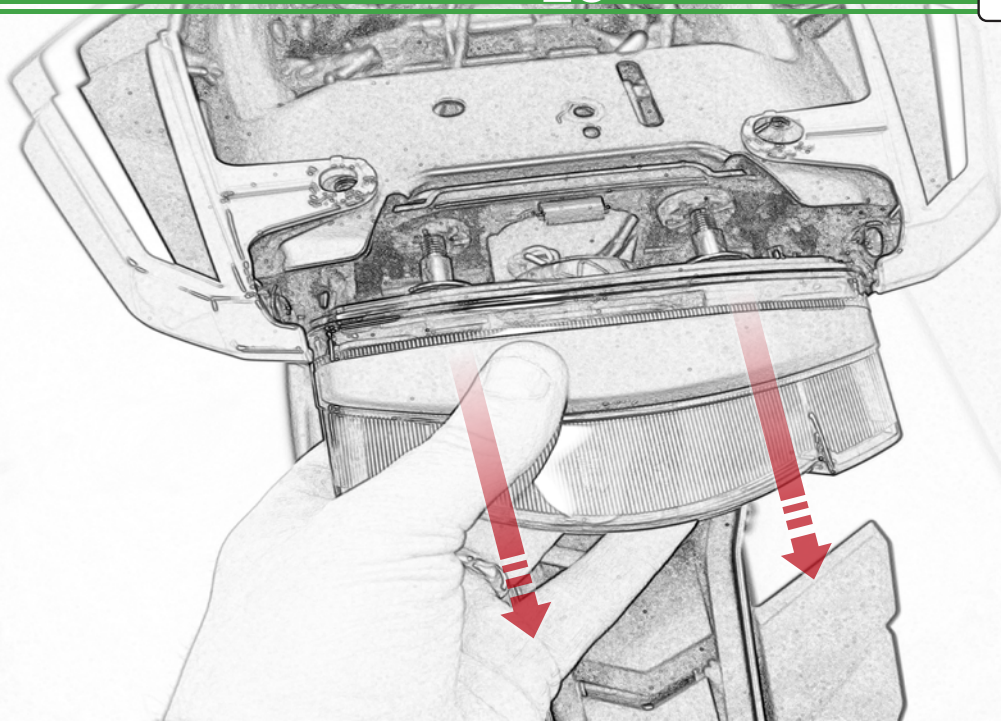

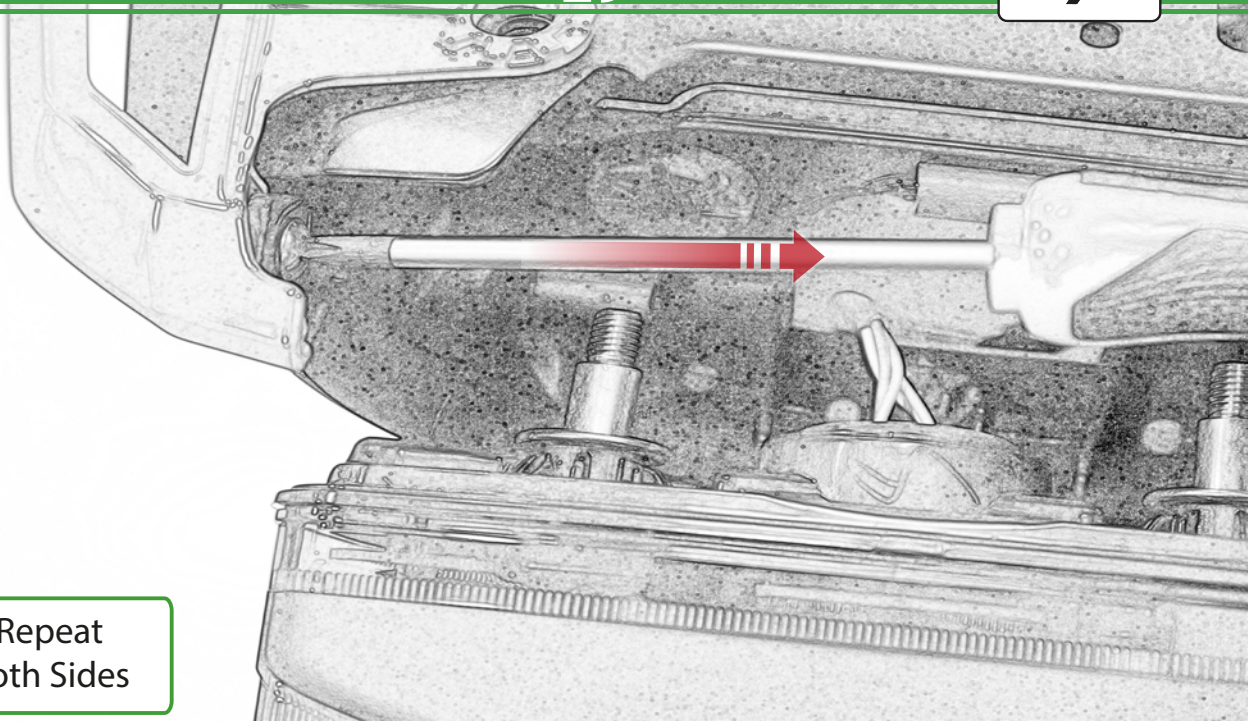

Repeat
Both Sides



Repeat
Both Sides

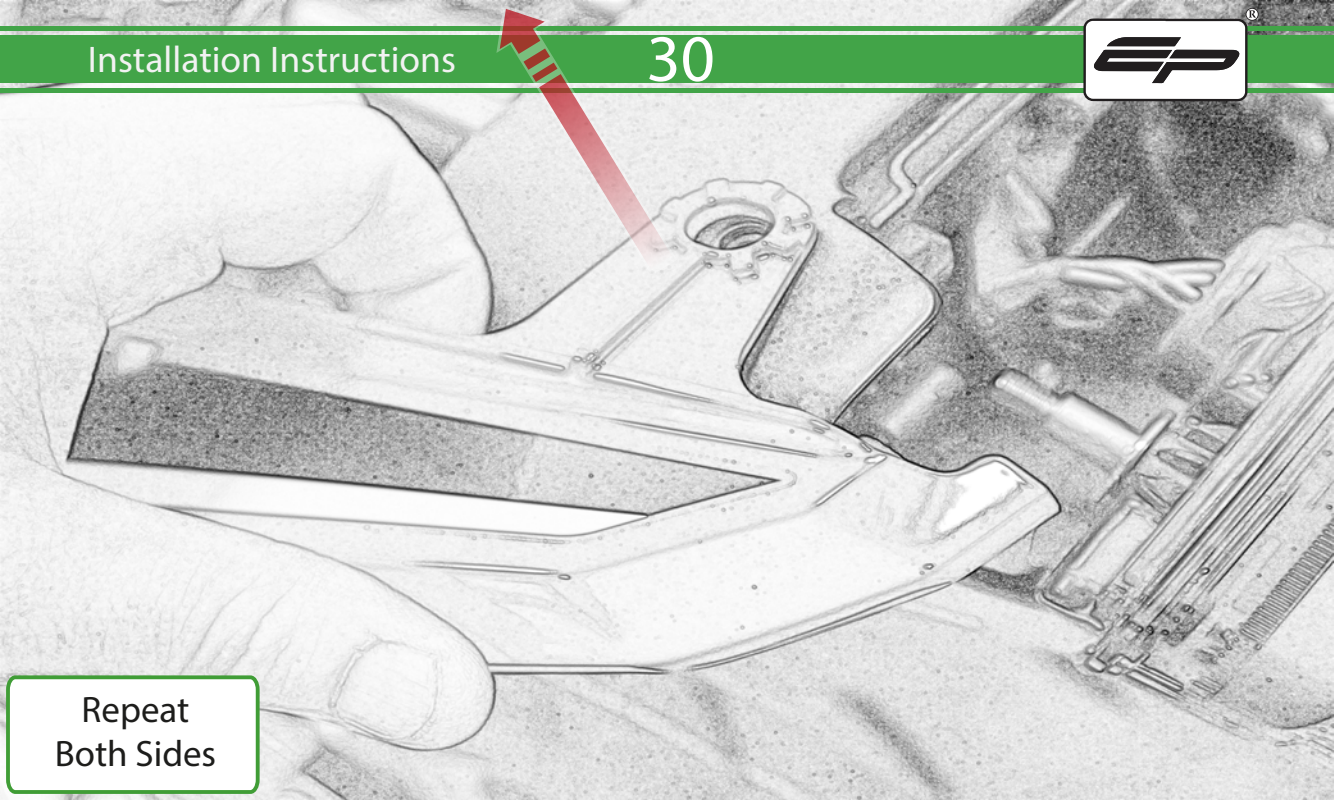



Release
Clips

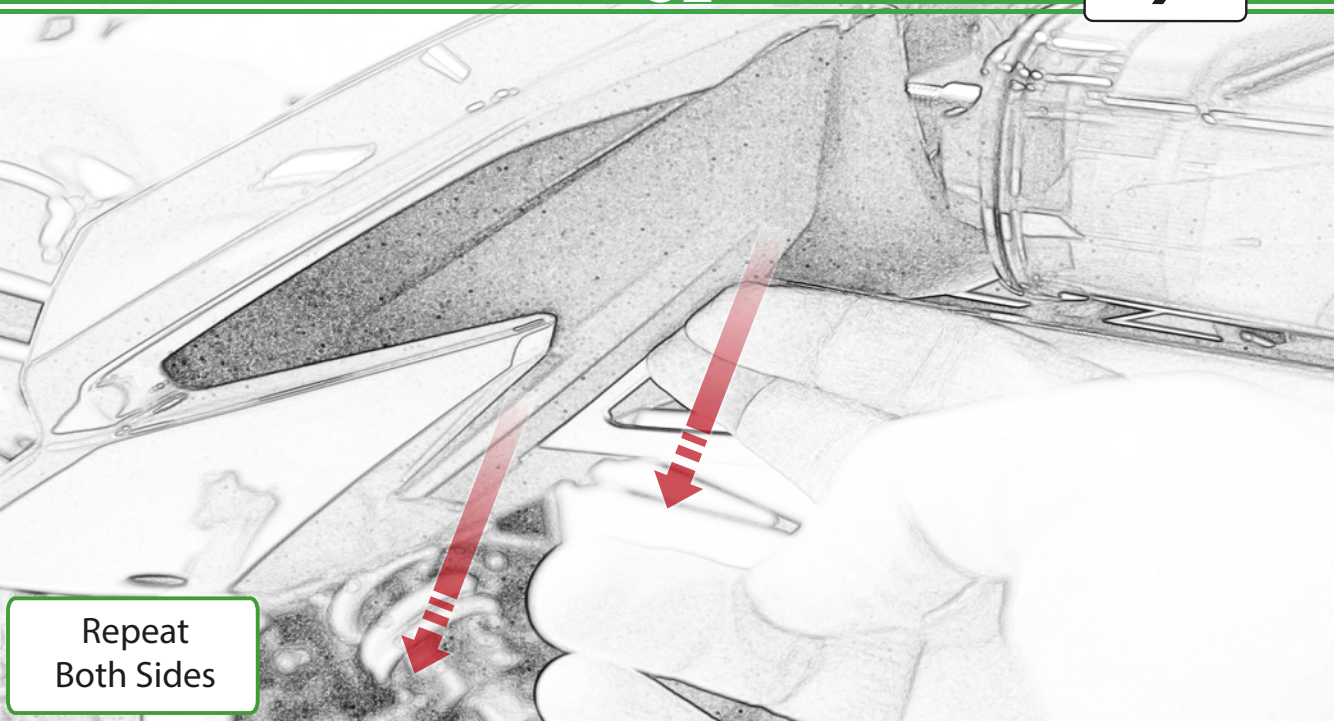

Repeat
Both Sides

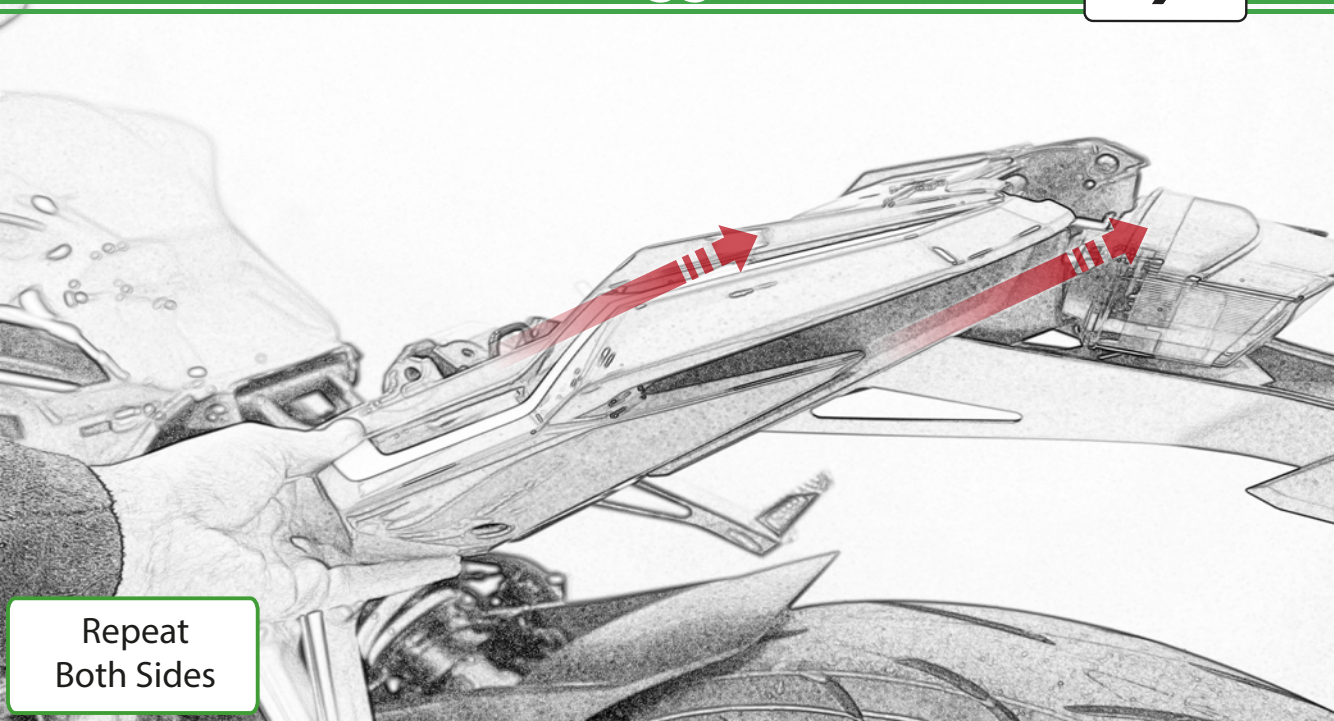

Repeat
Both Sides

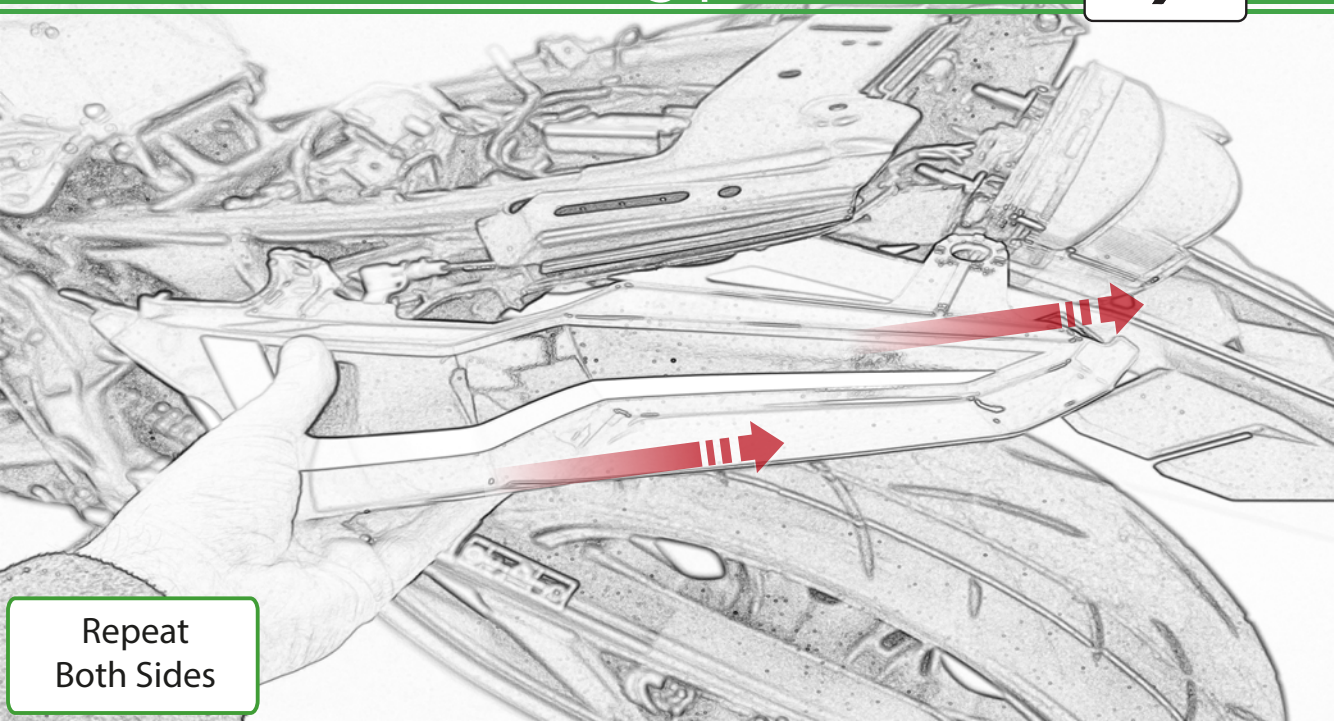

Repeat
Both Sides

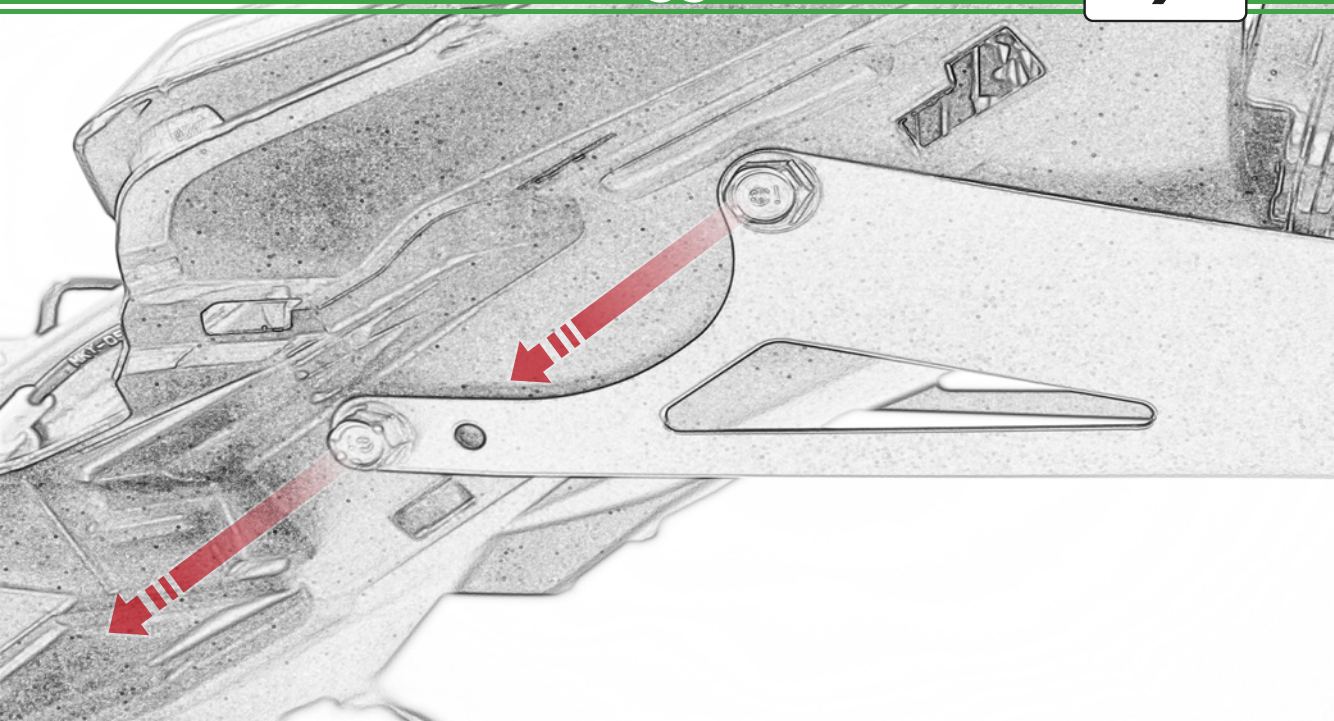

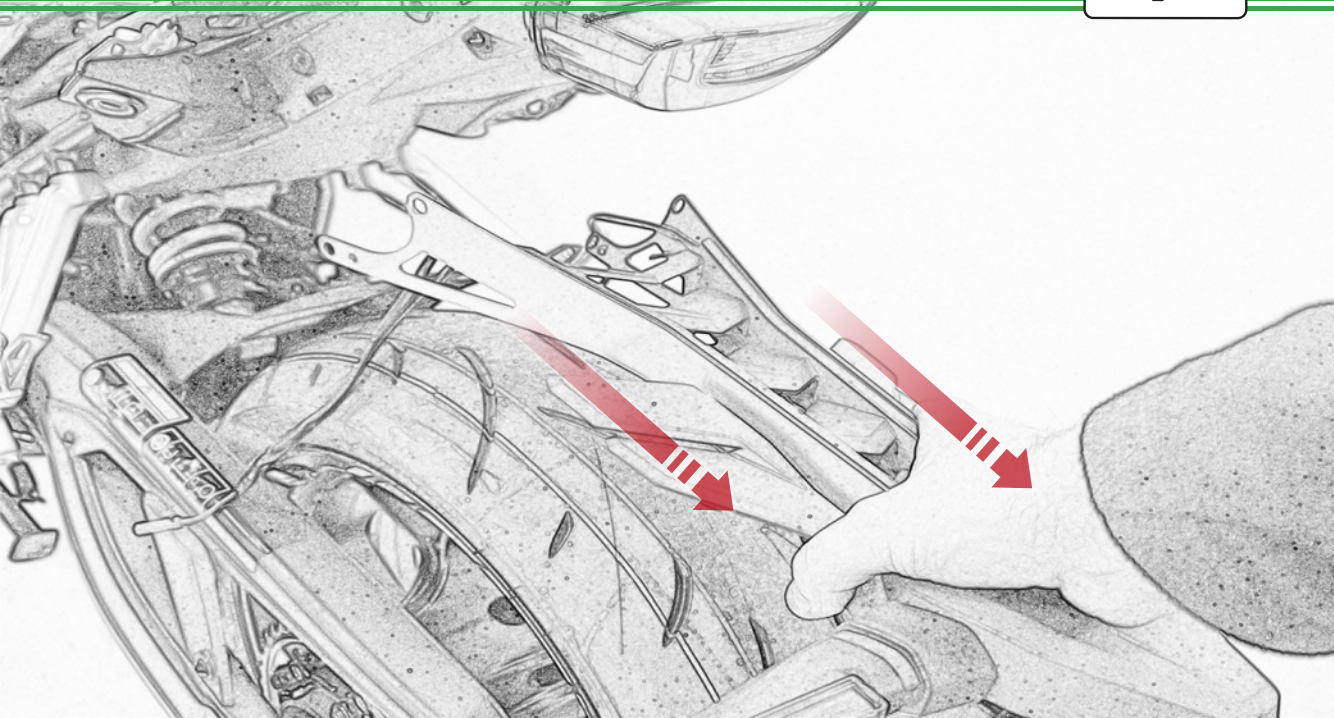

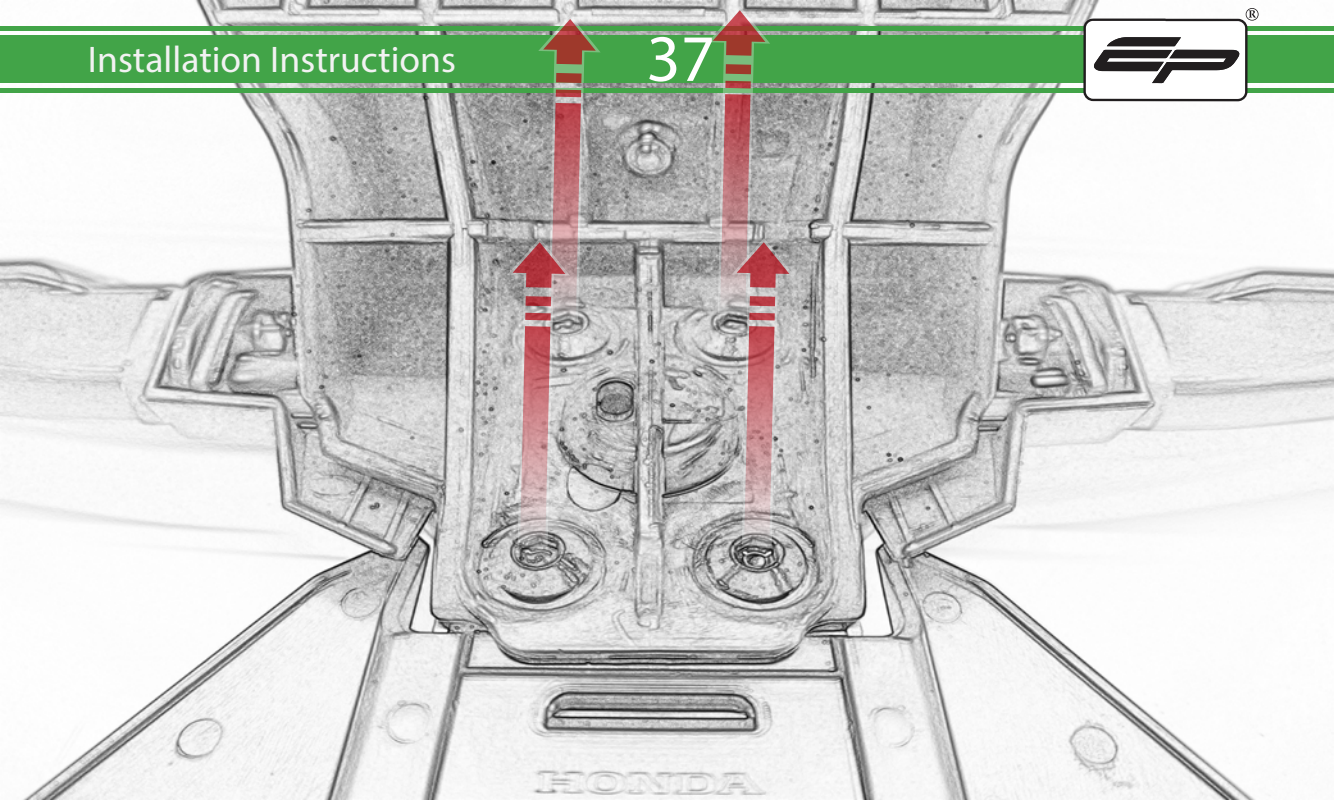

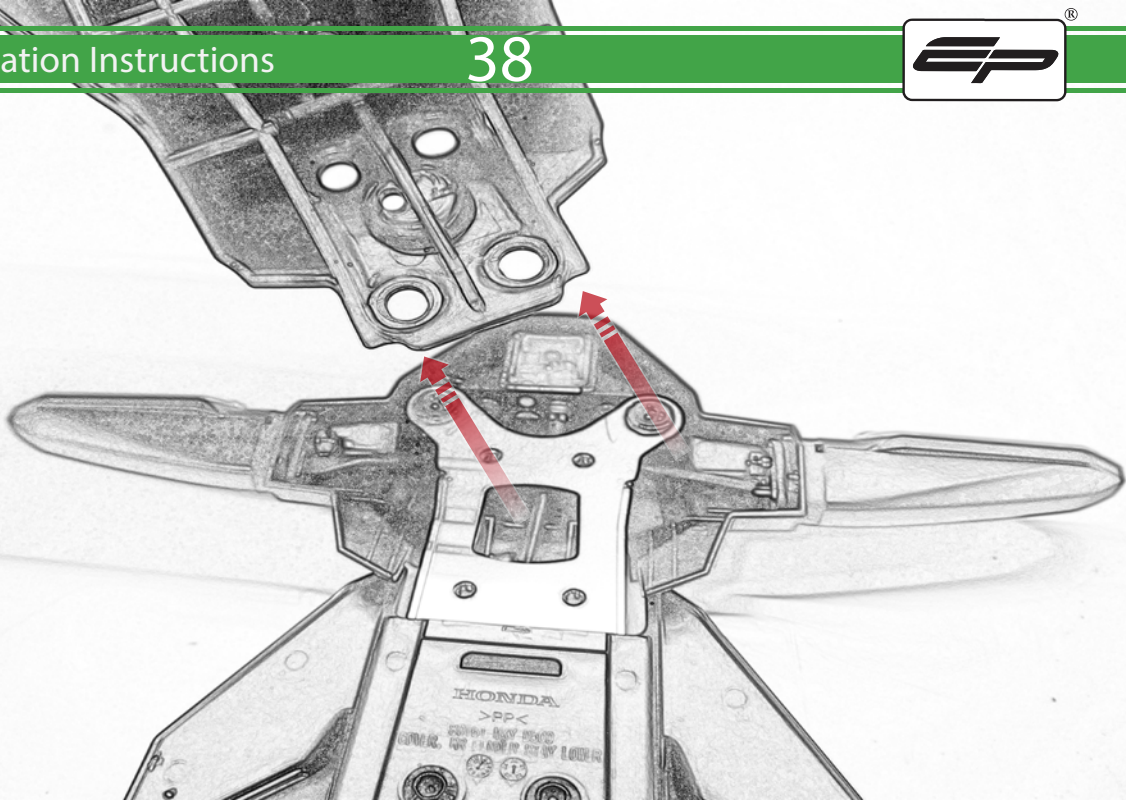

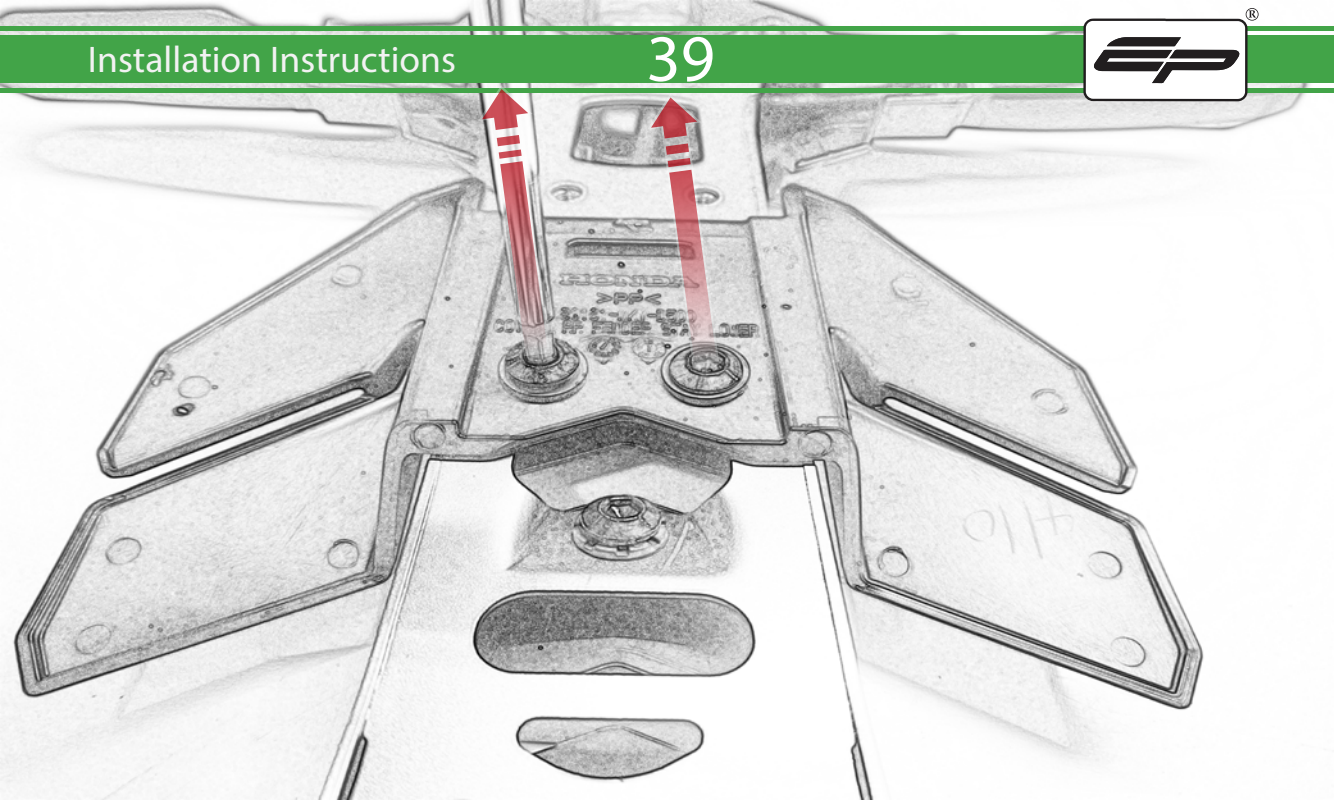

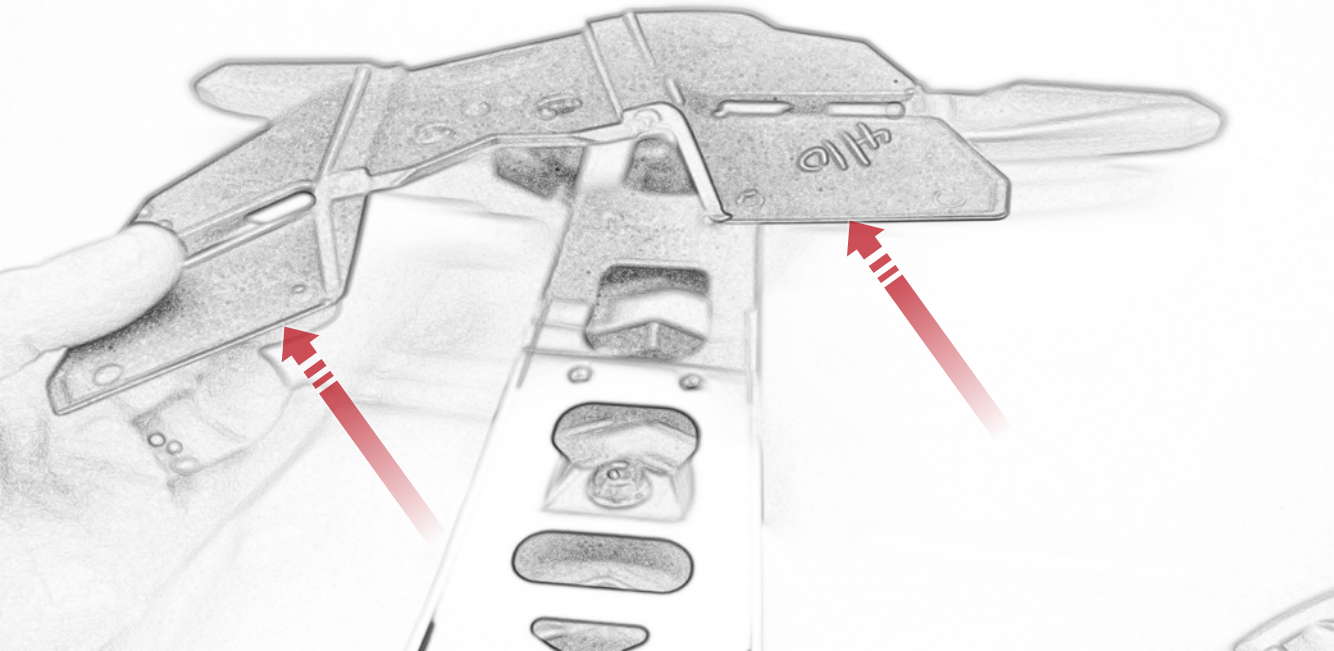

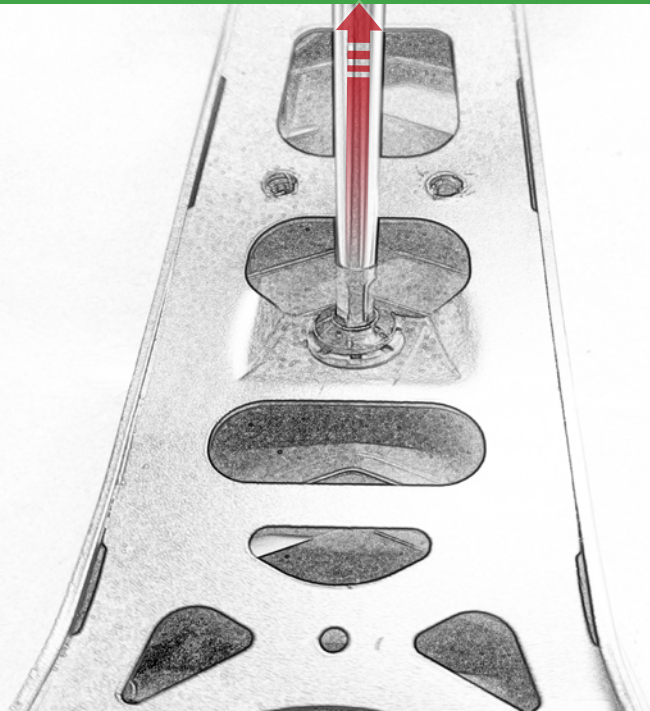

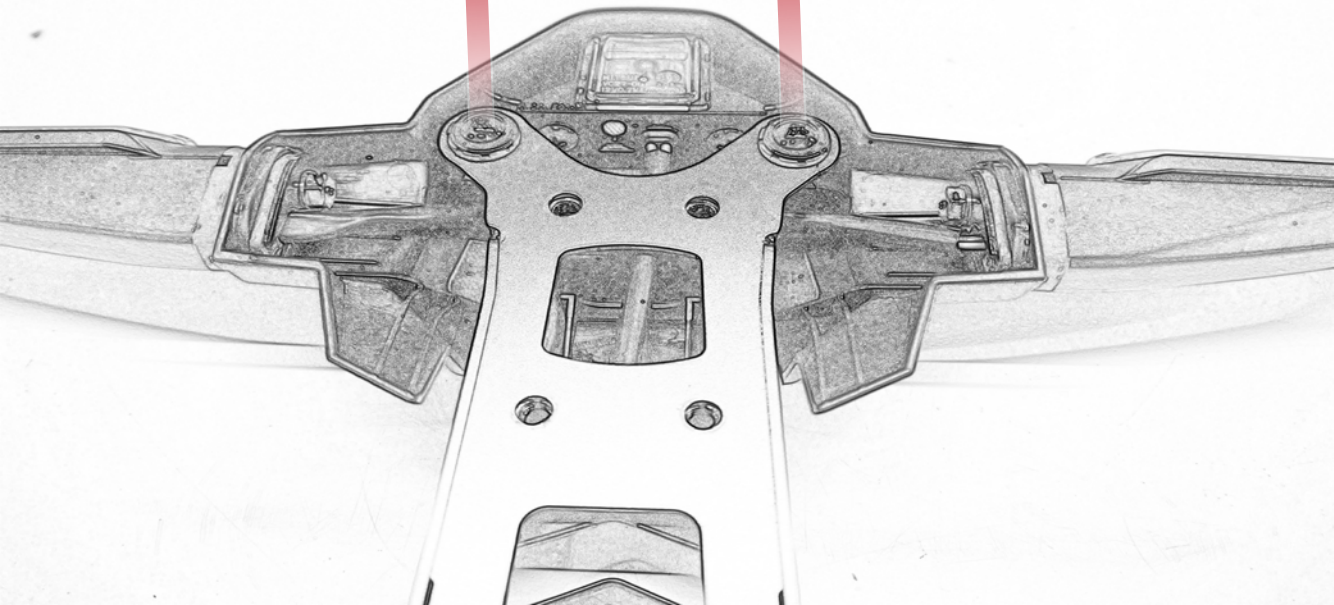

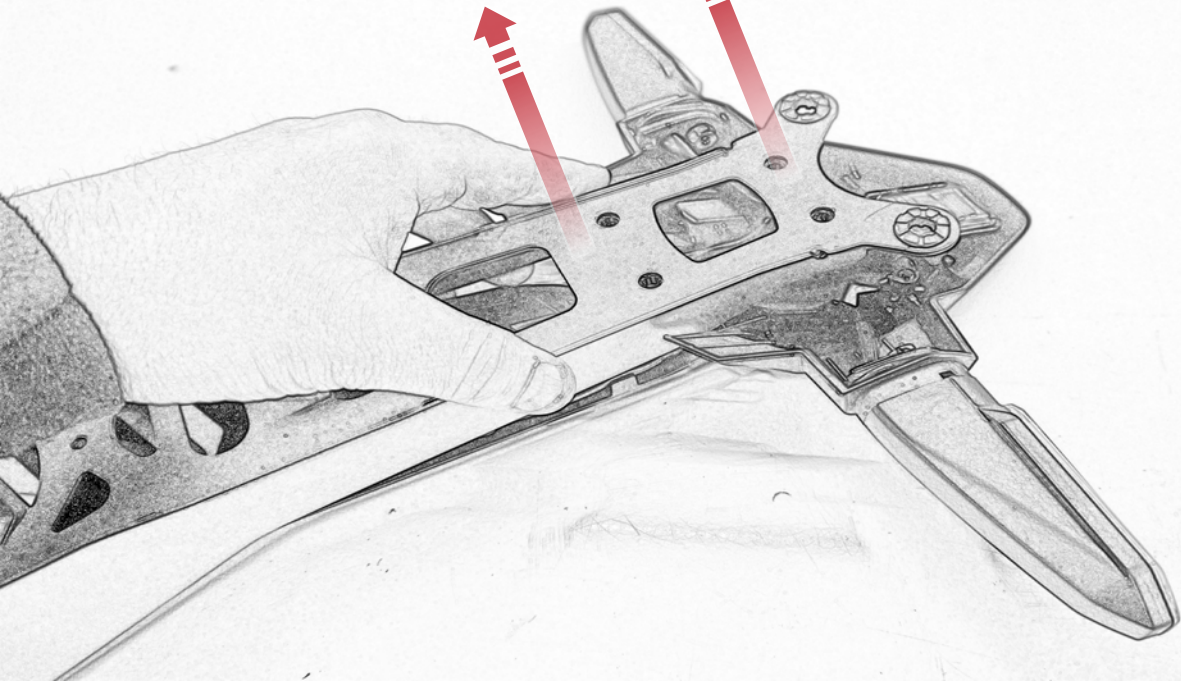

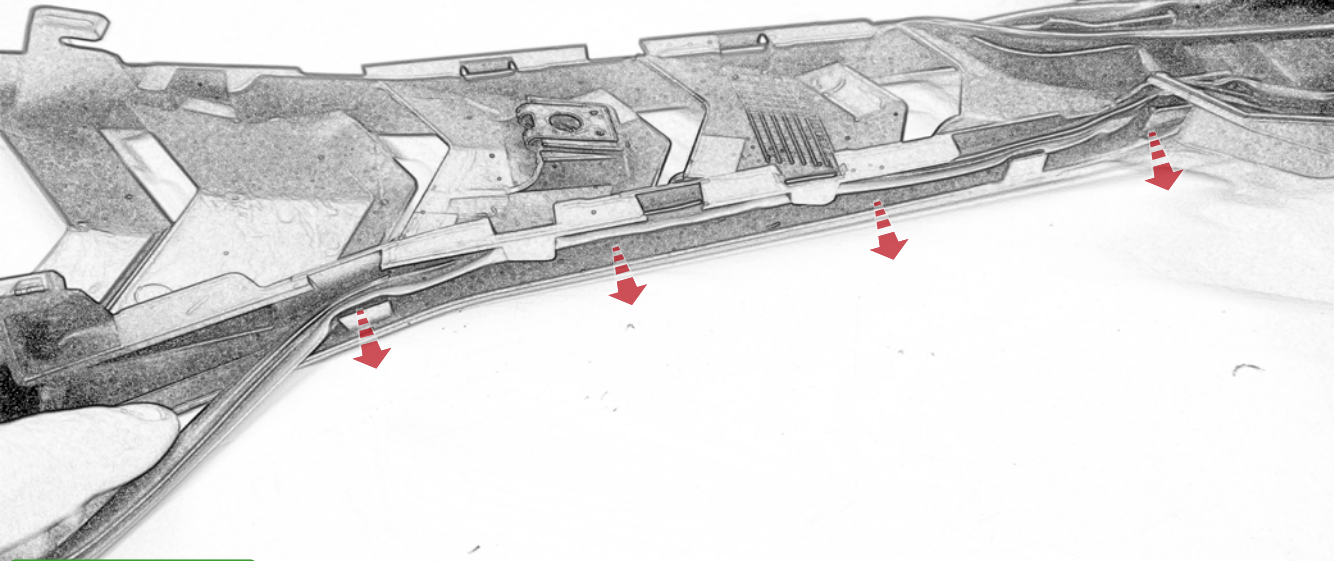

Repeat
Both Sides

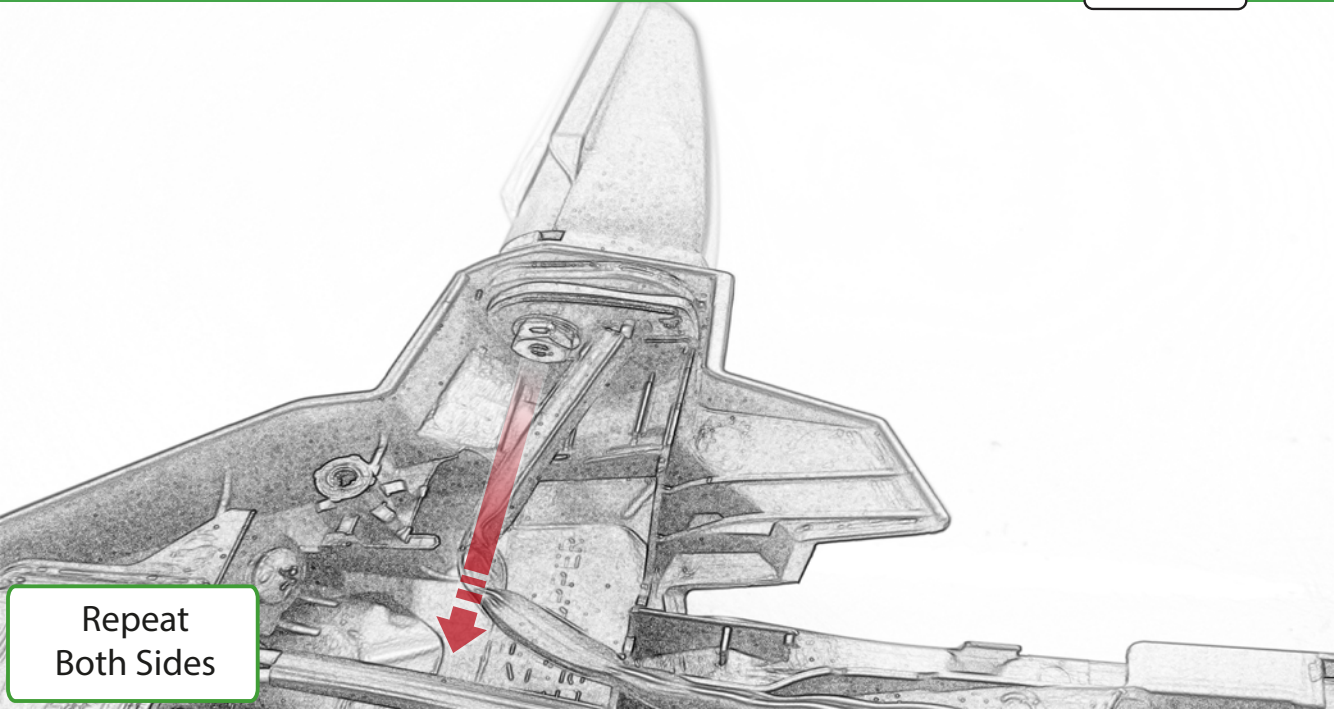

Repeat
Both Sides

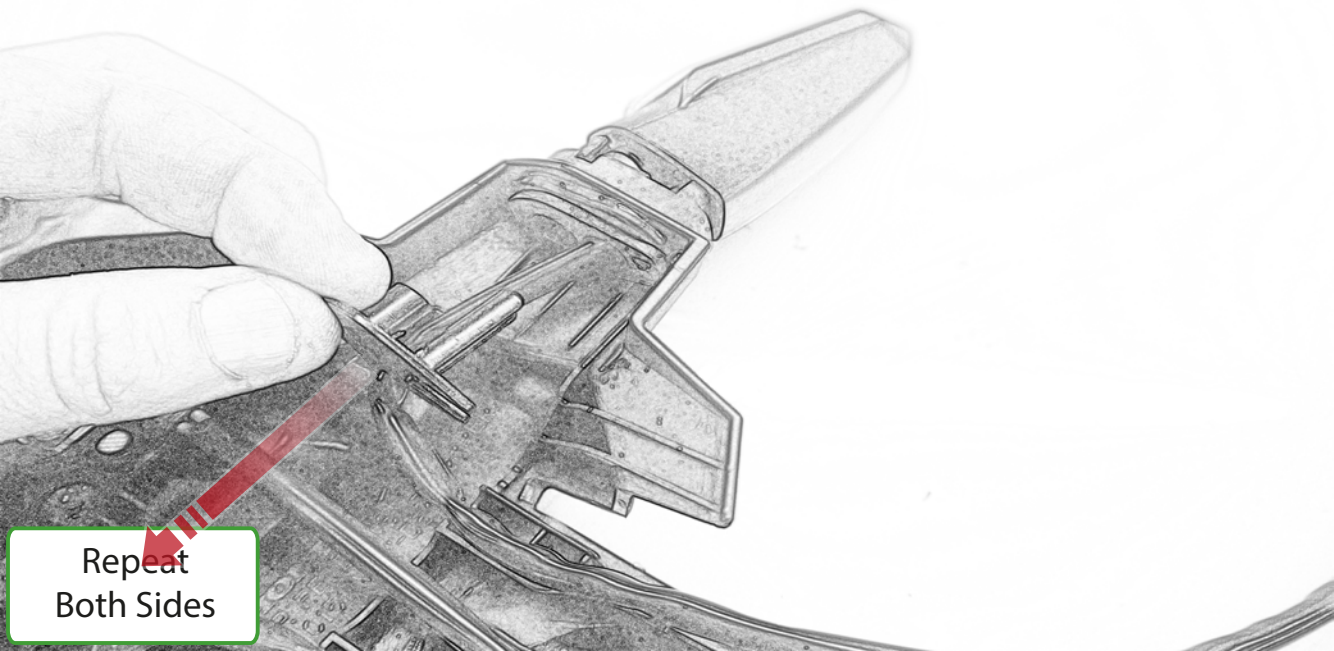

Repeat
Both Sides

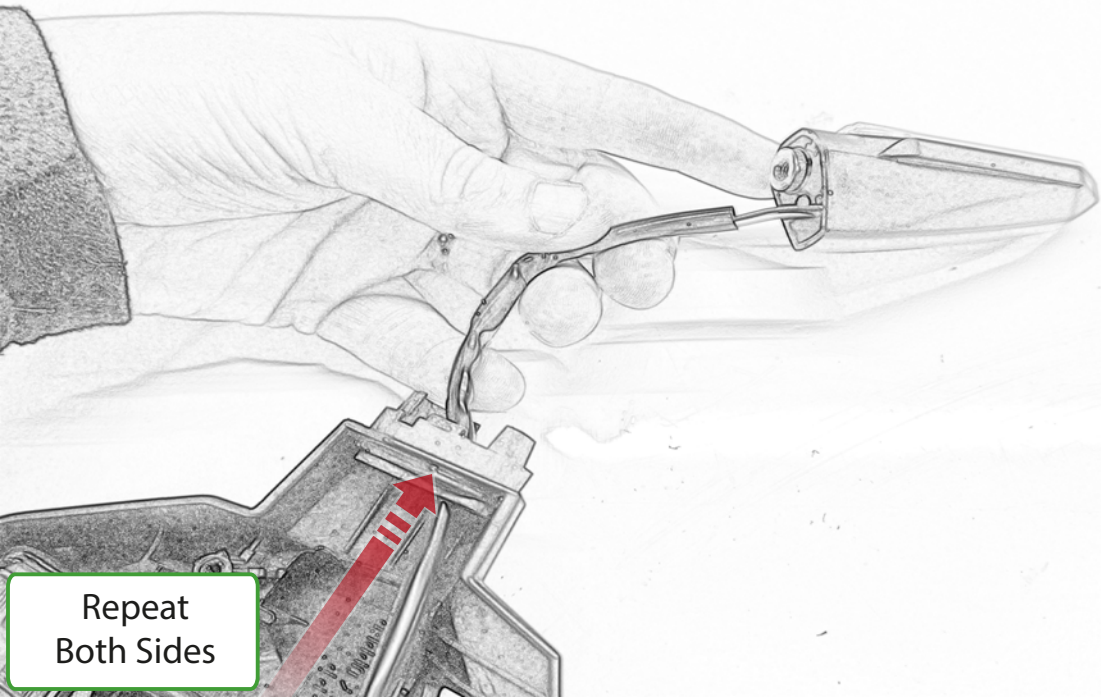

Repeat
Both Sides

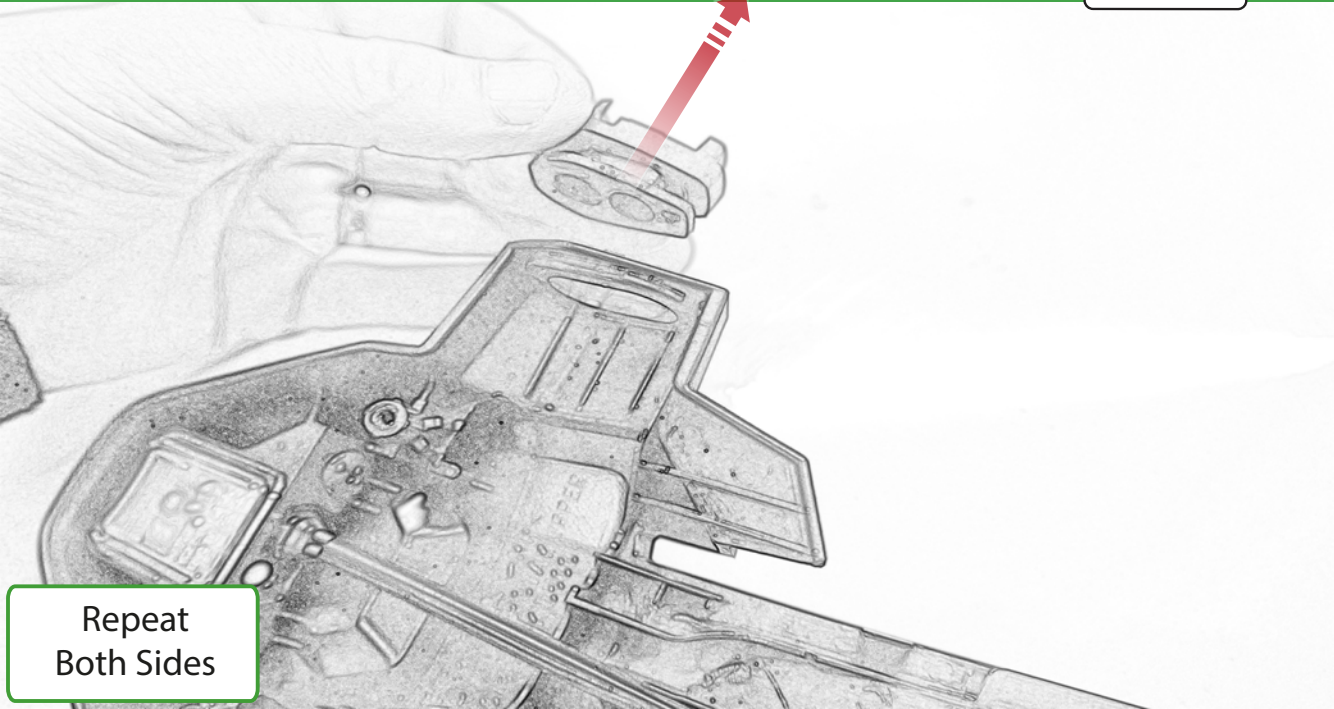

Repeat
Both Sides

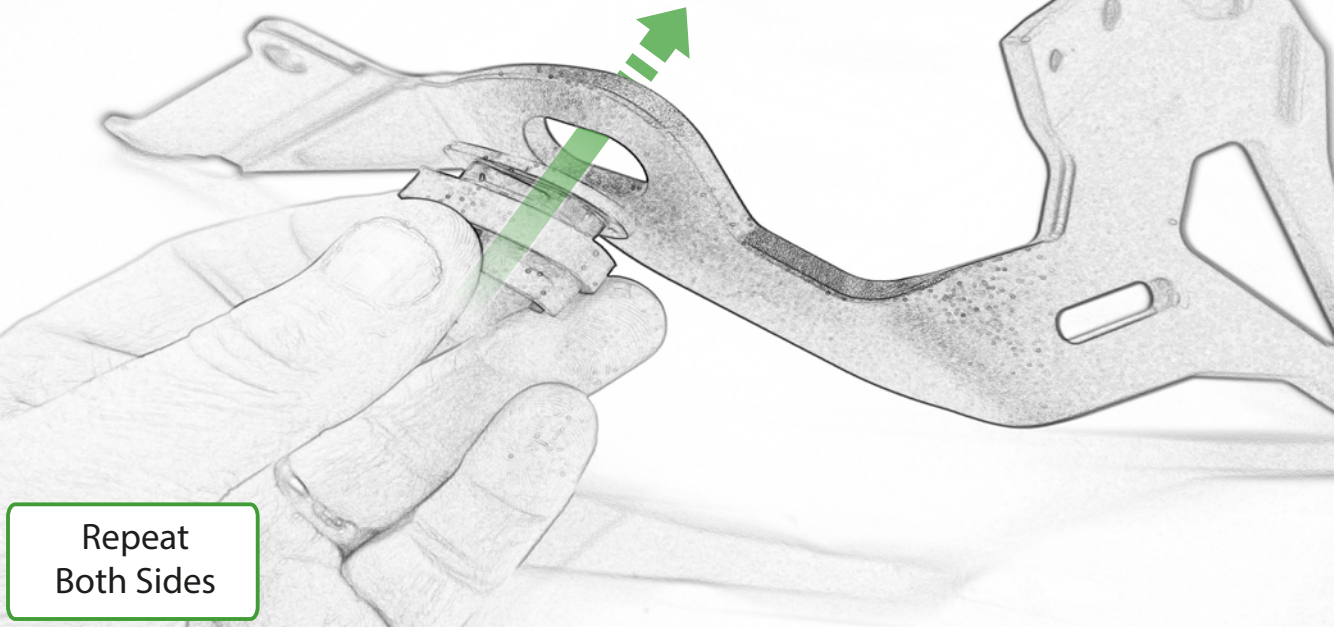

Repeat
Both Sides

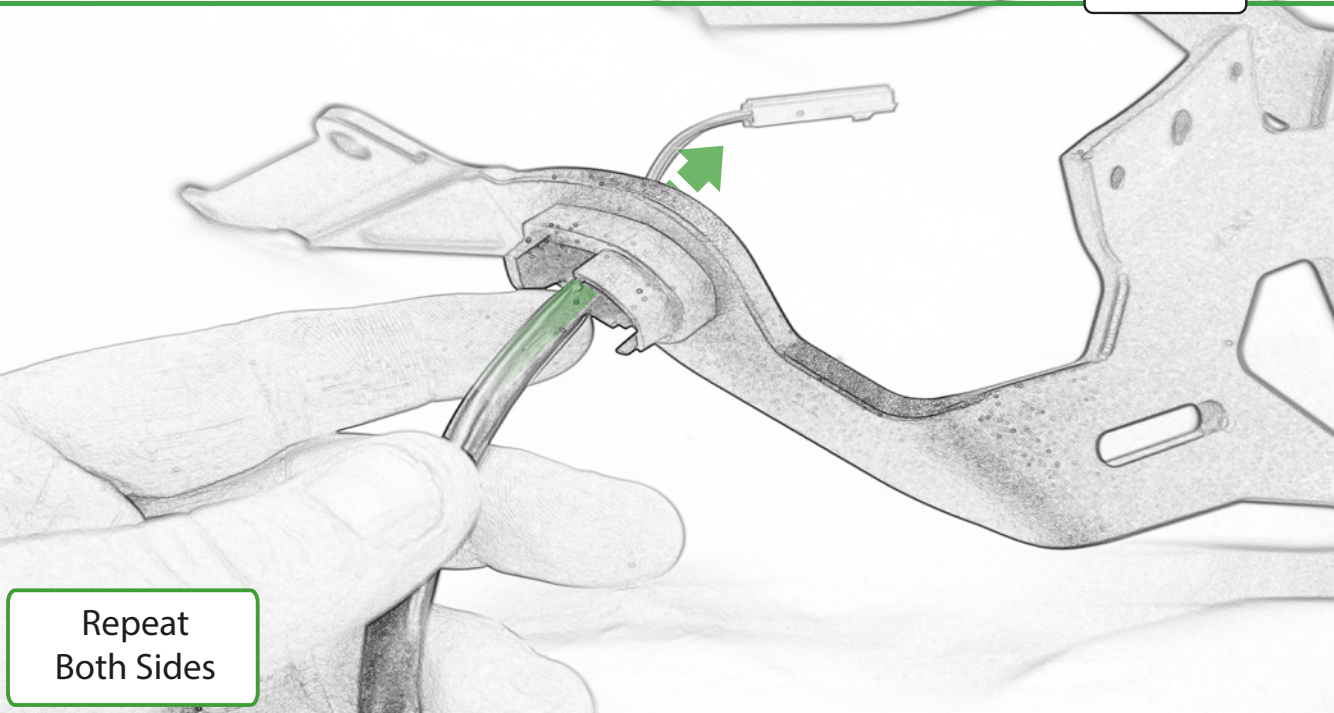

Repeat
Both Sides

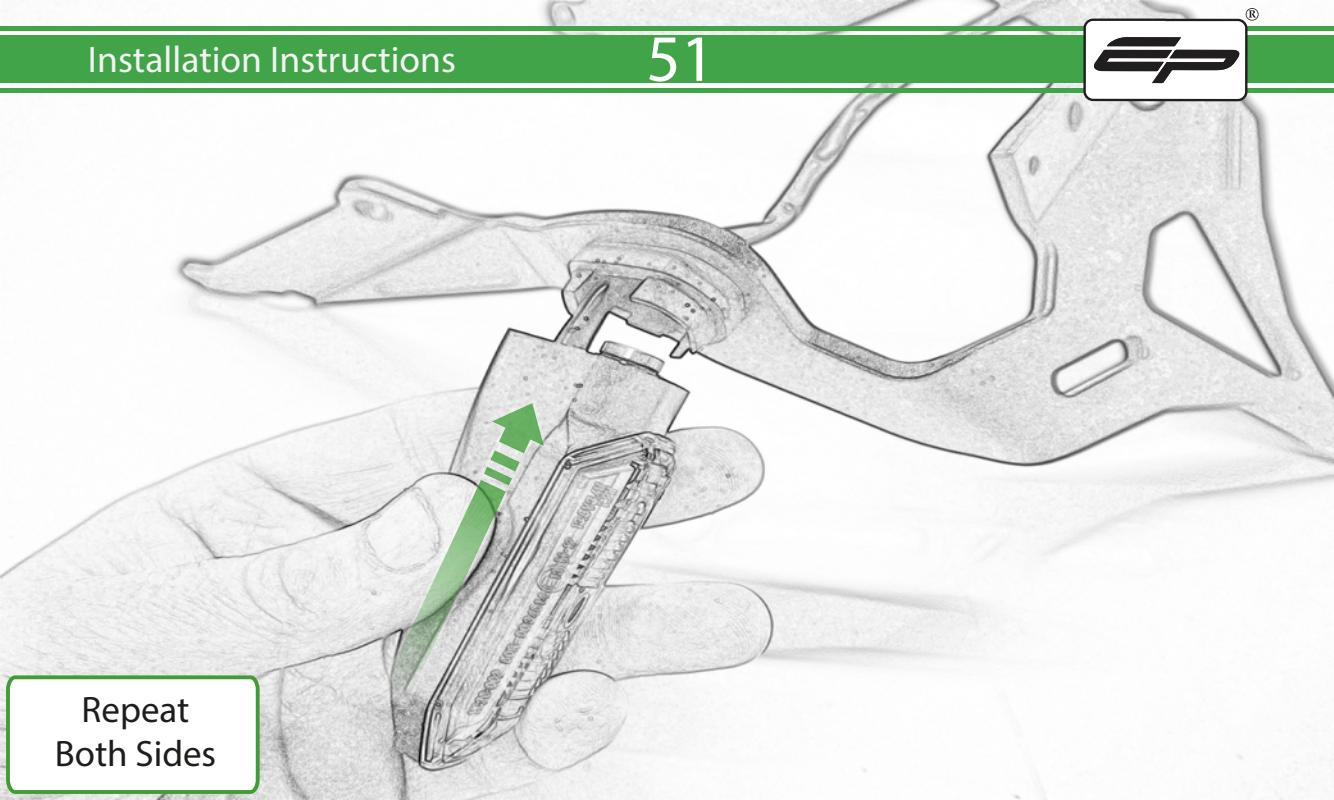

Repeat
Both Sides

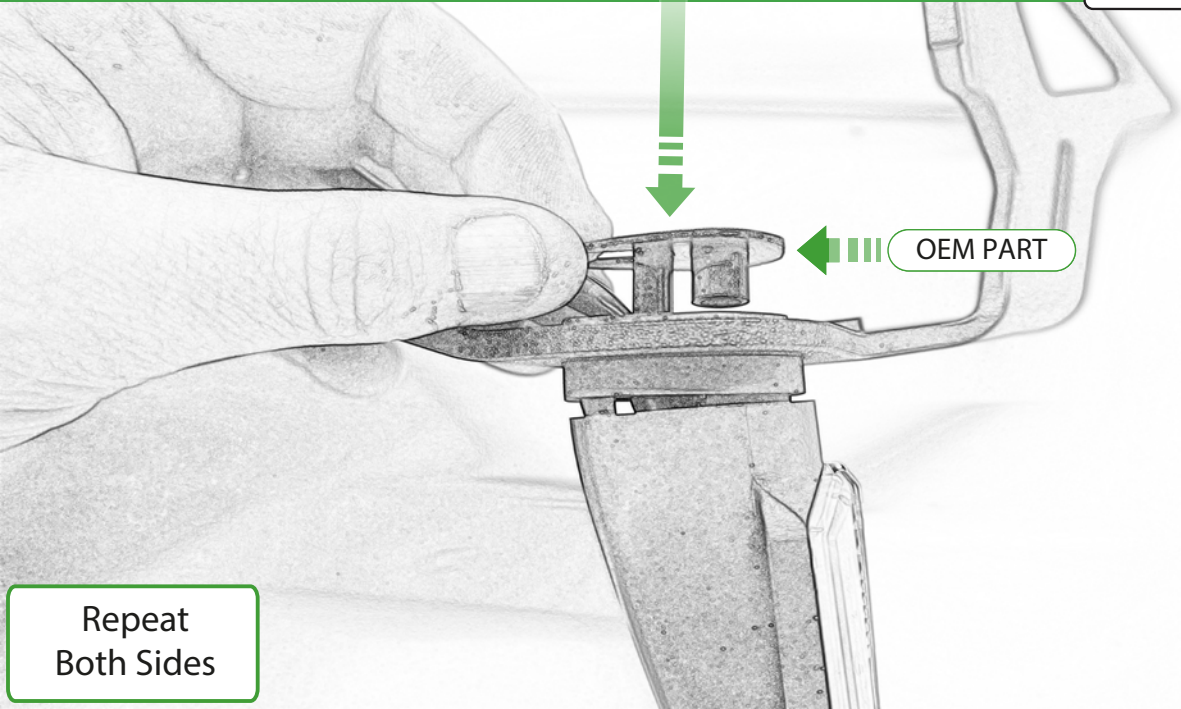

OEM PART

Repeat
Both Sides

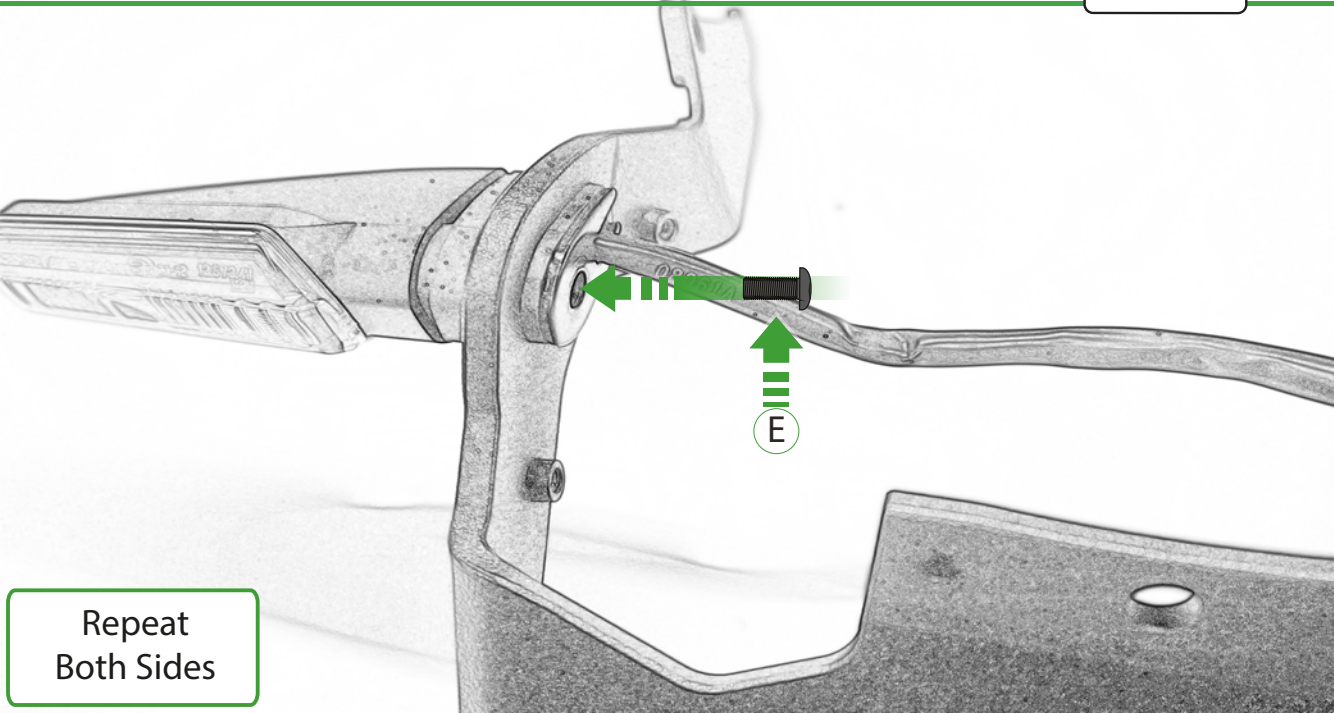

Repeat
Both Sides

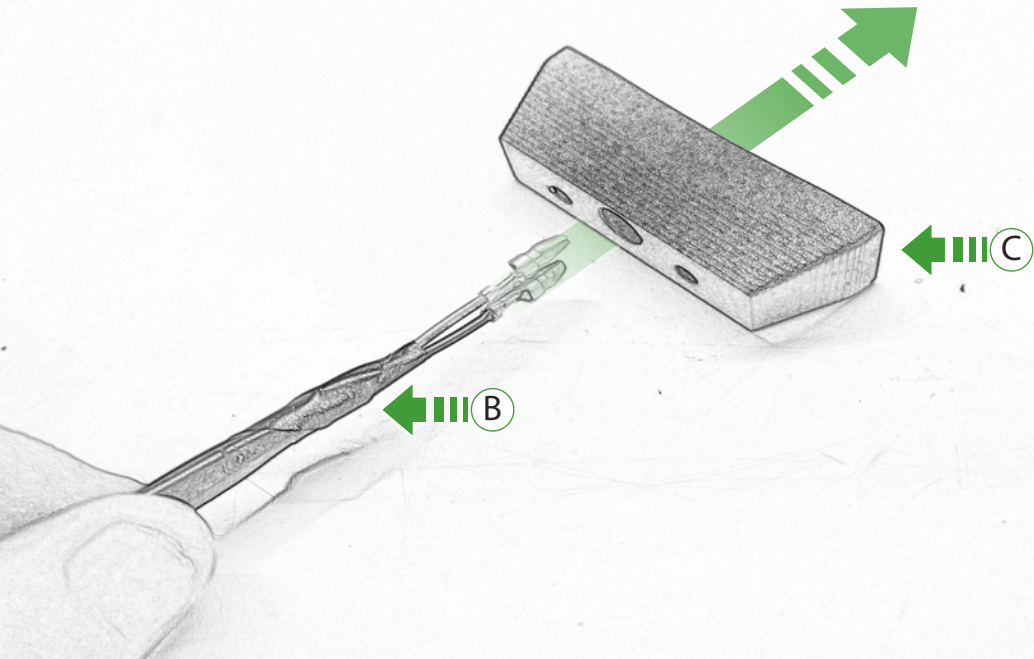

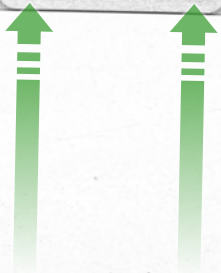
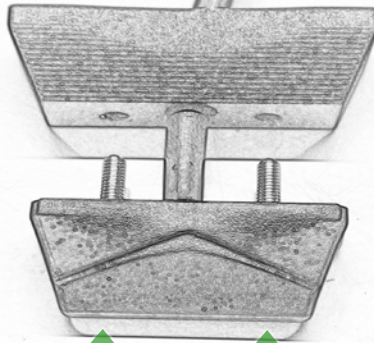

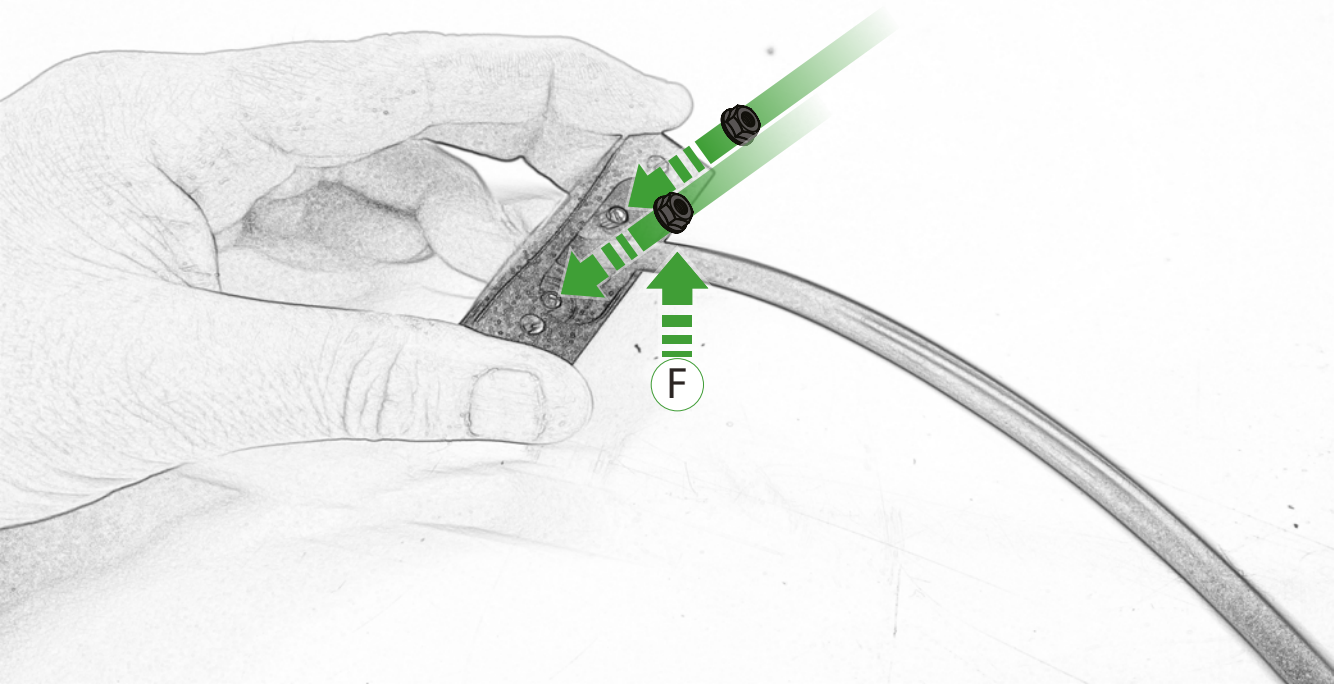

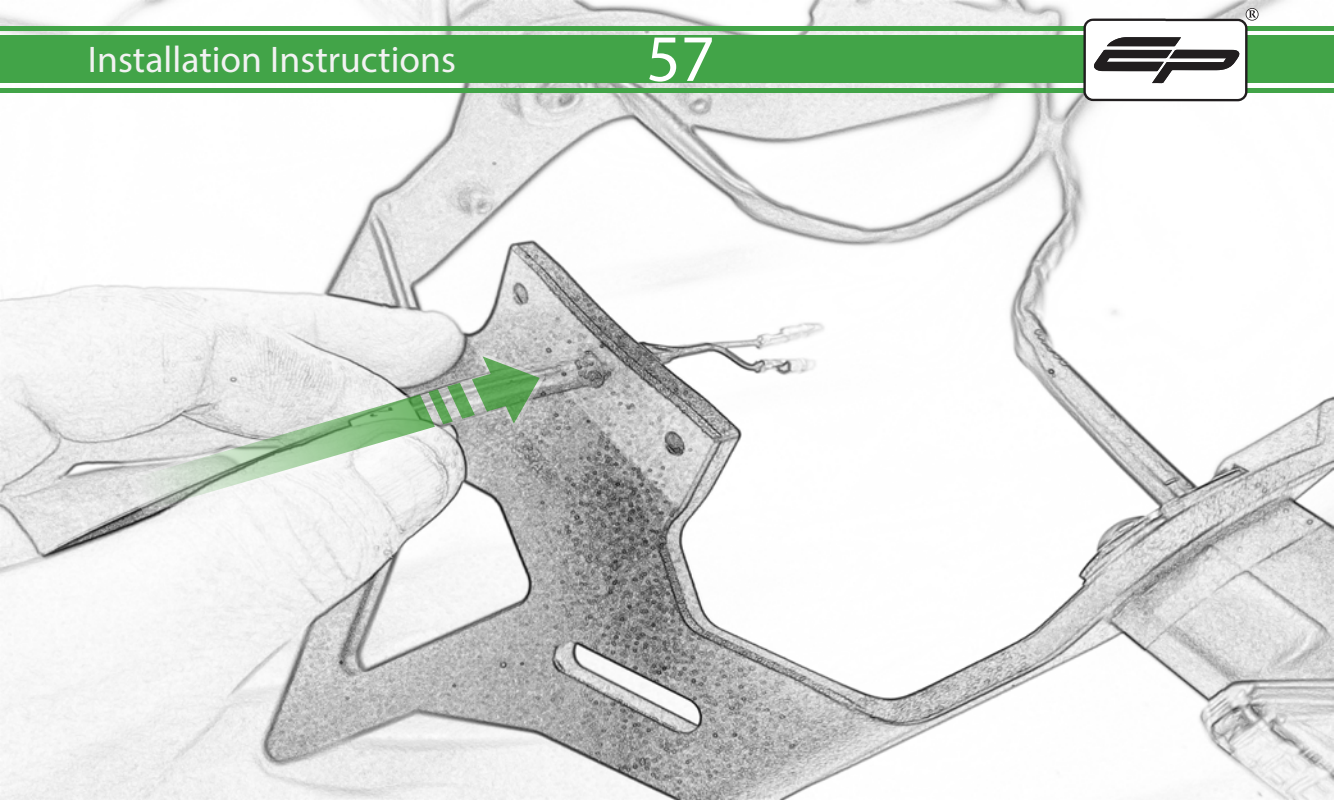

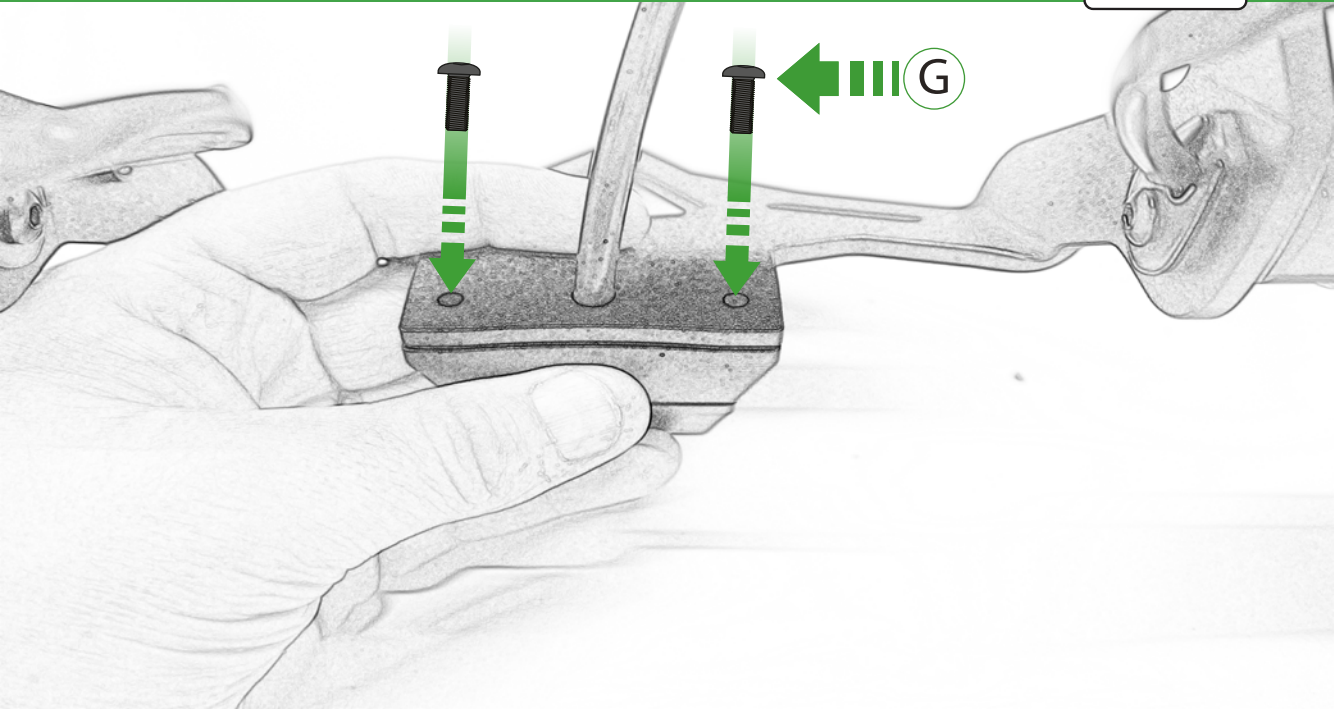

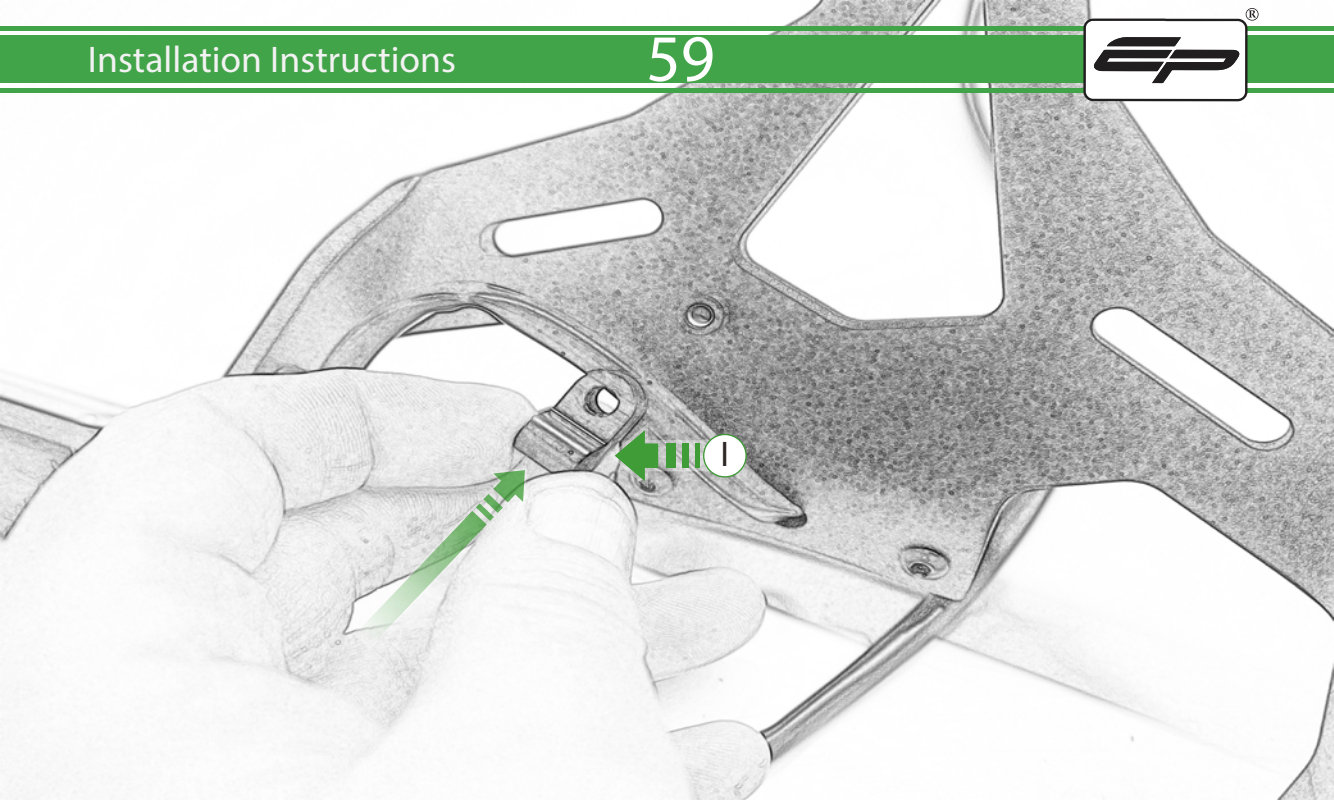

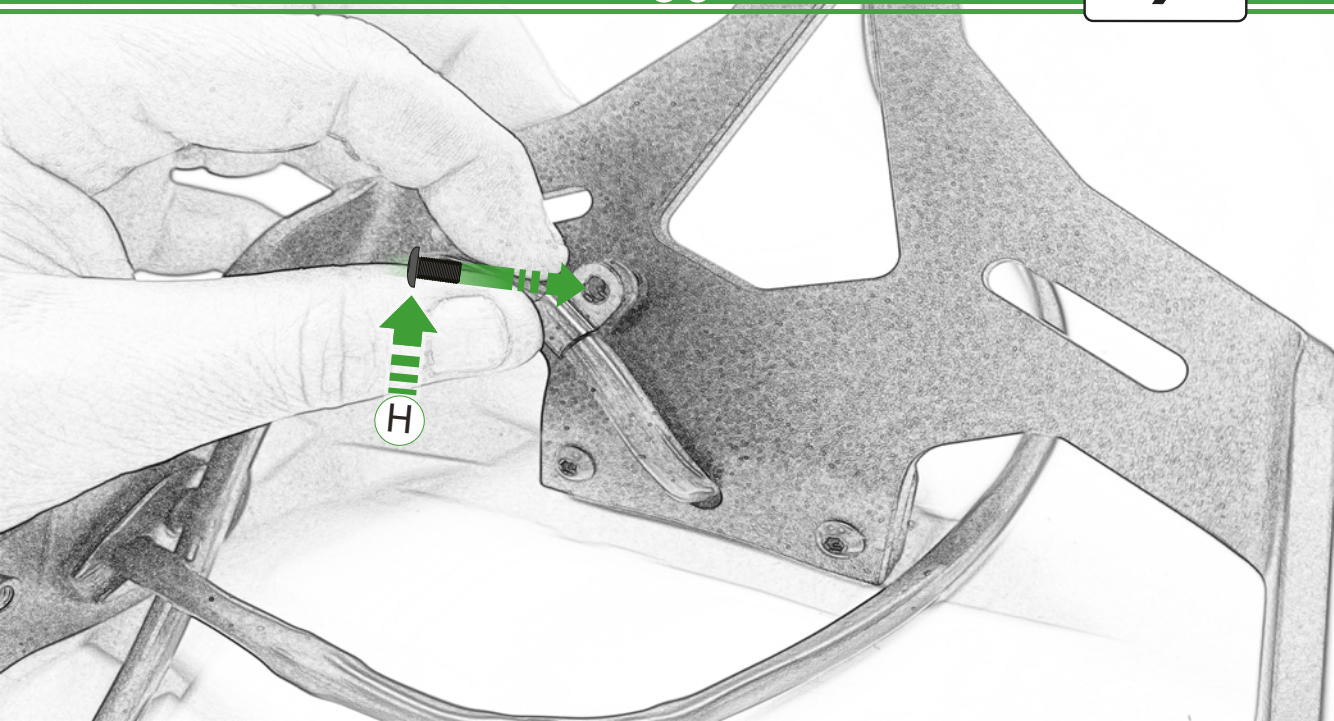

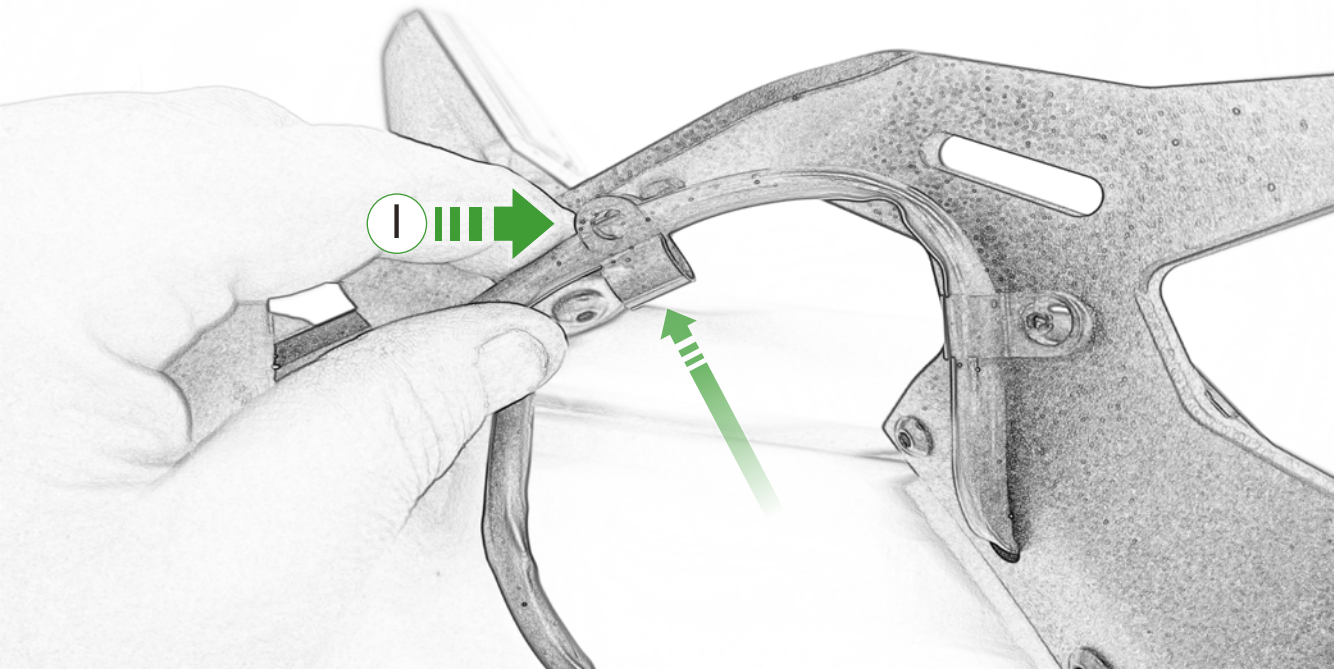



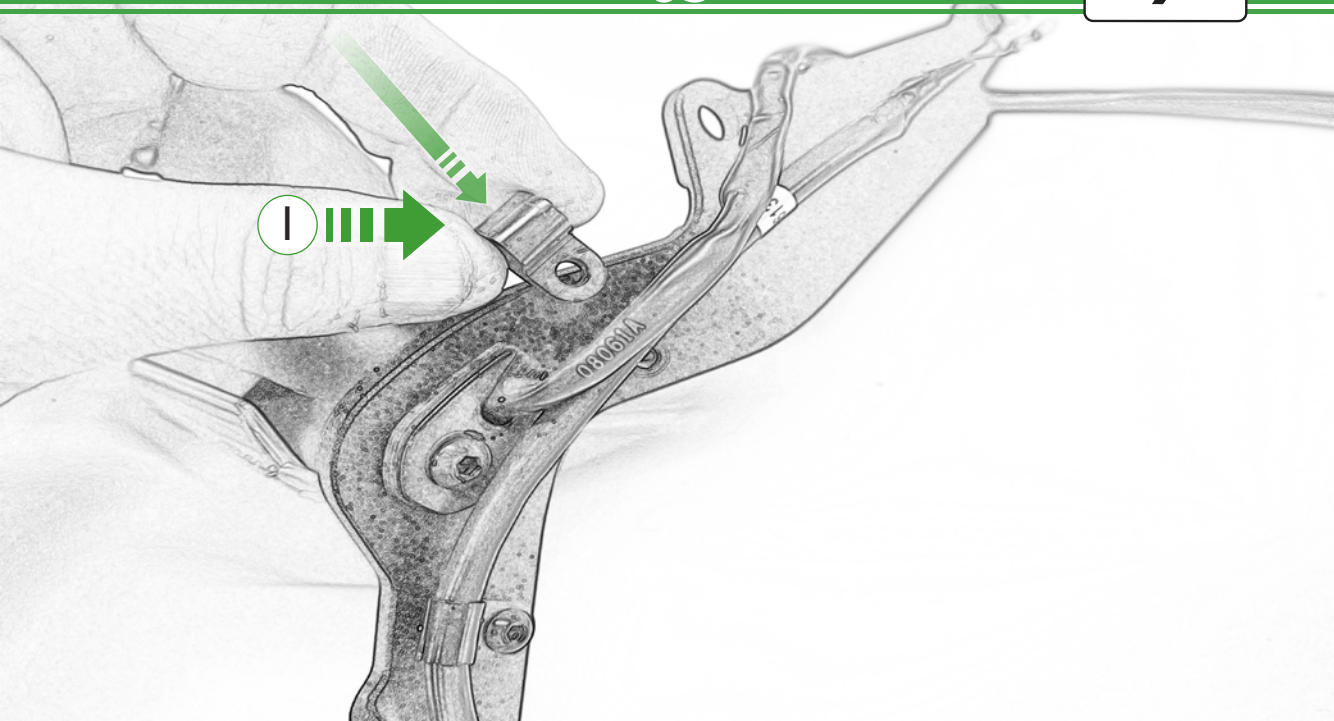

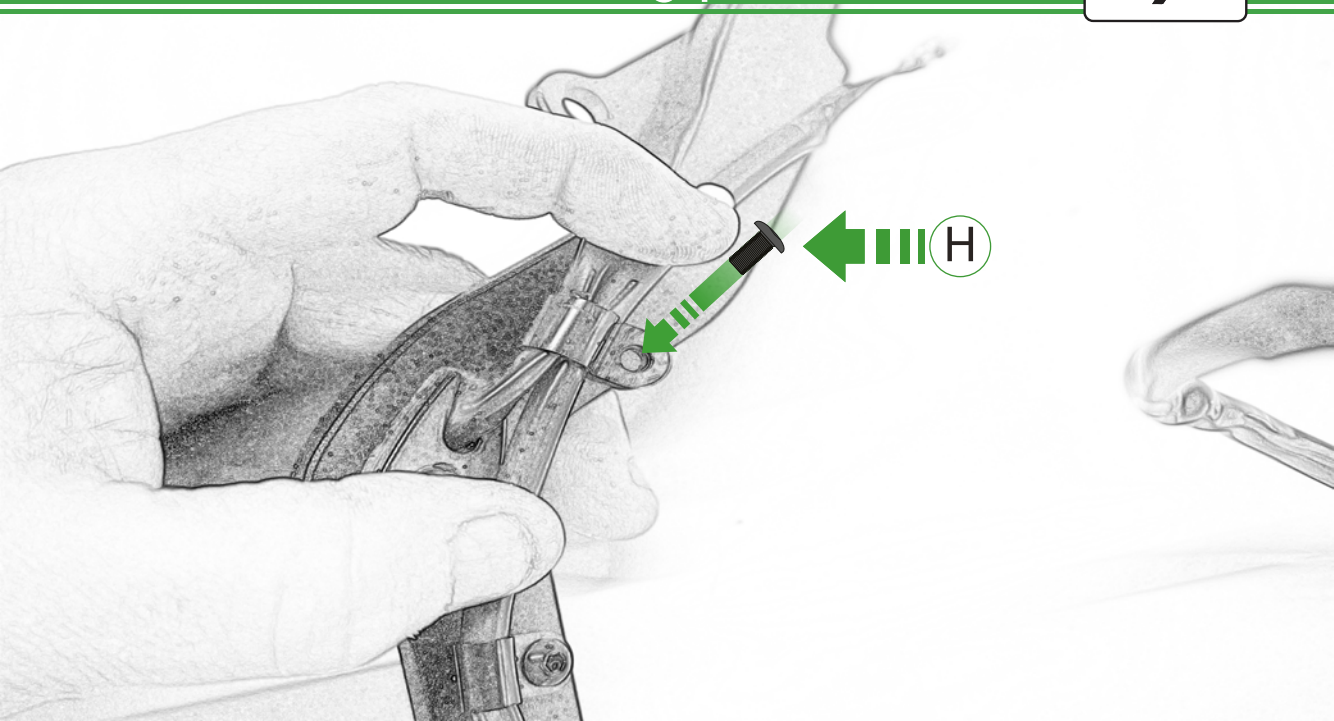

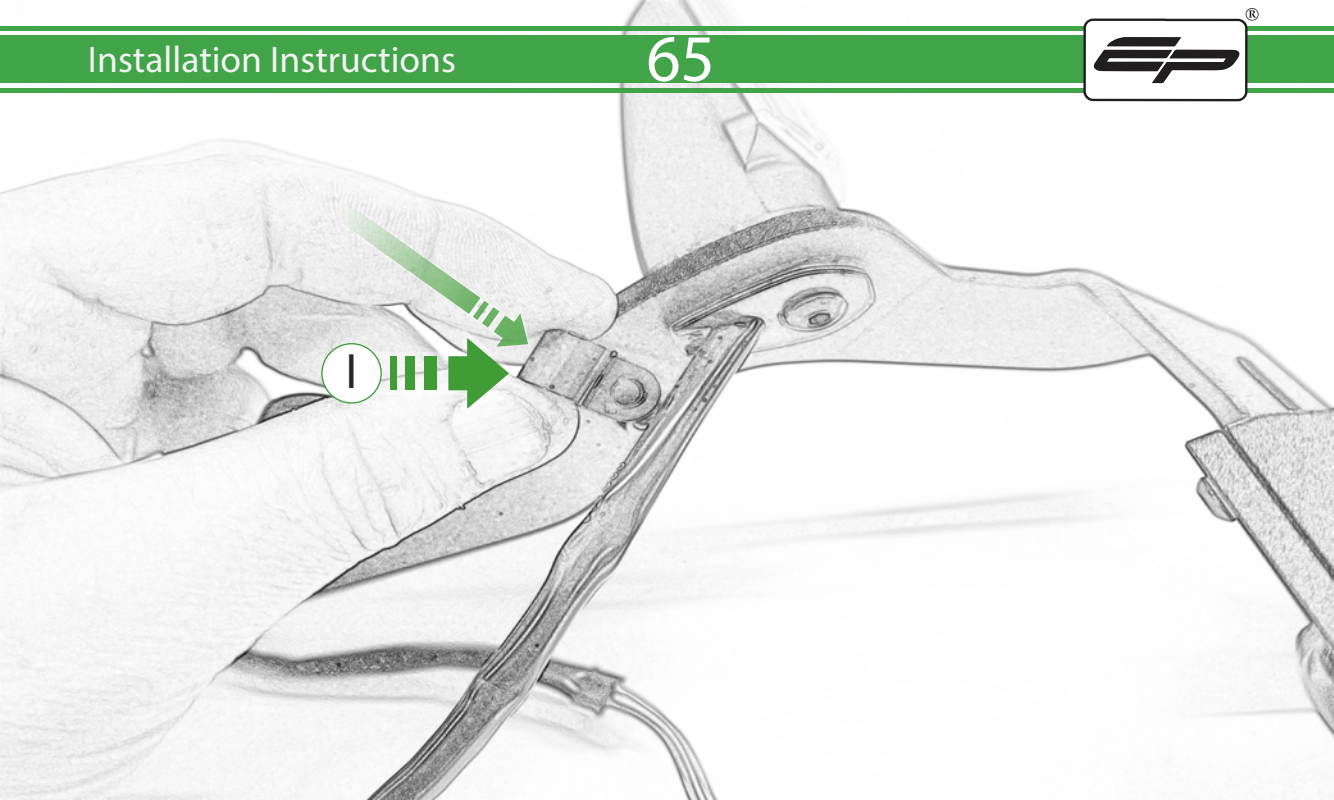

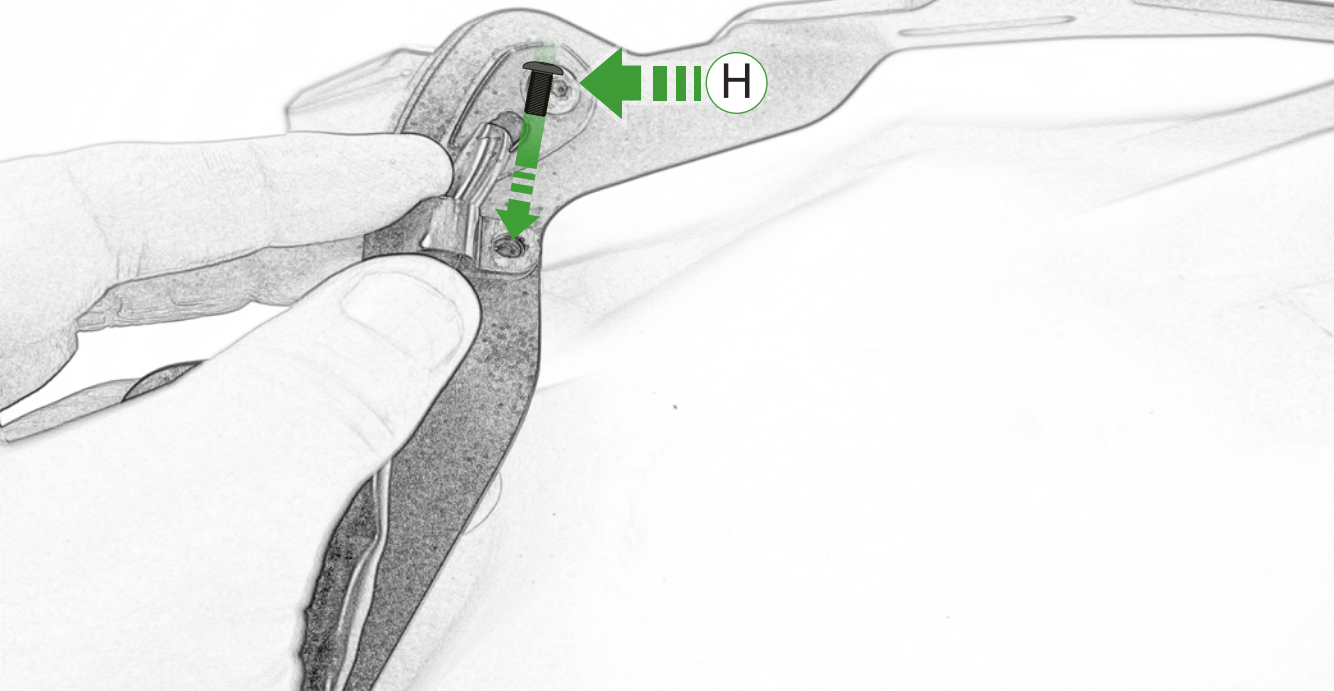

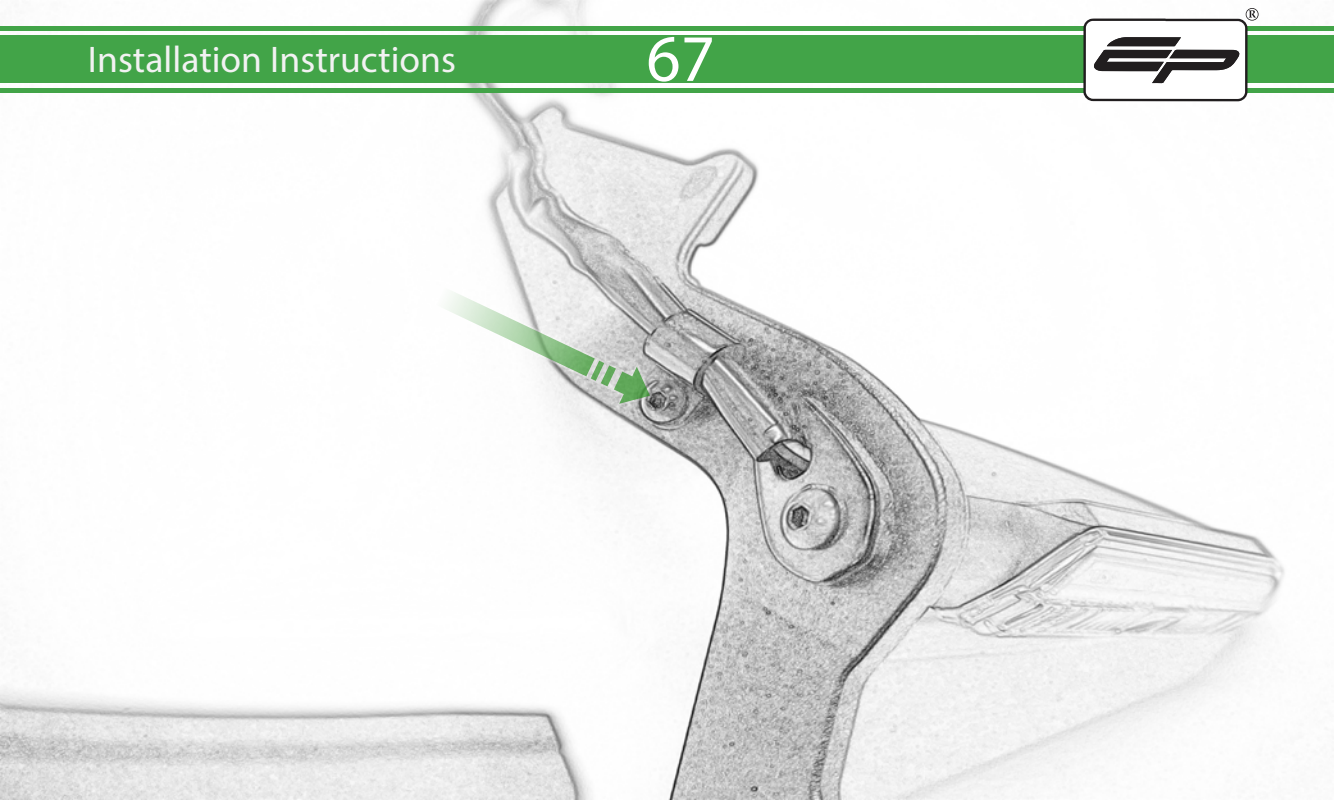

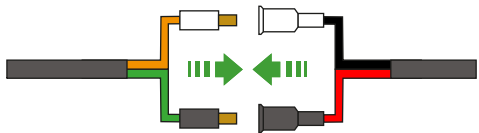
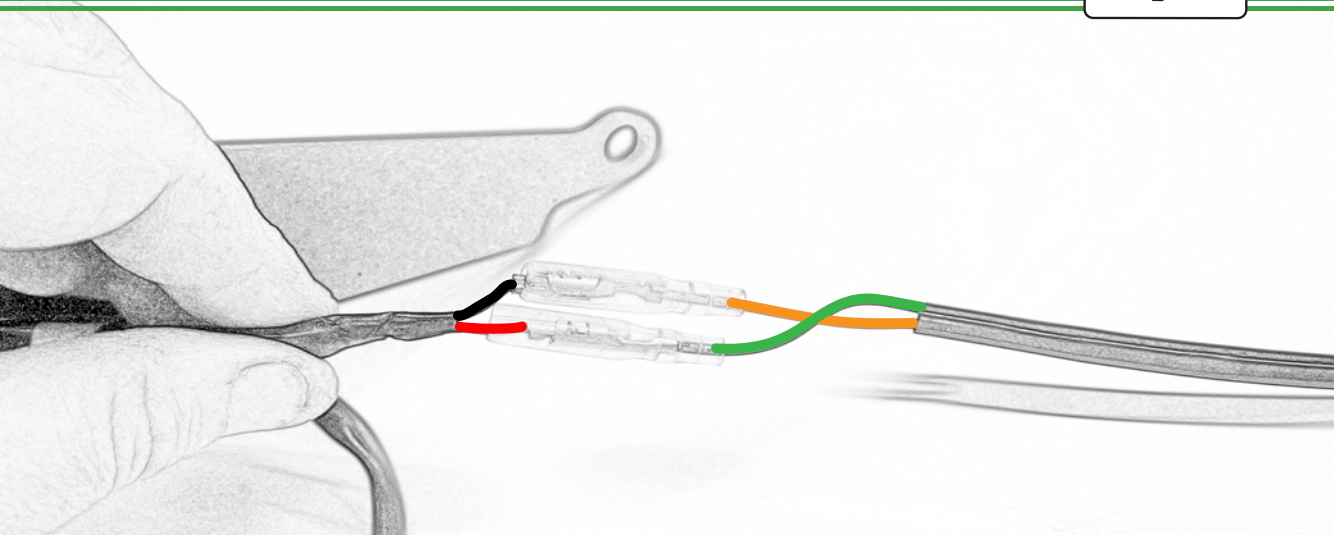

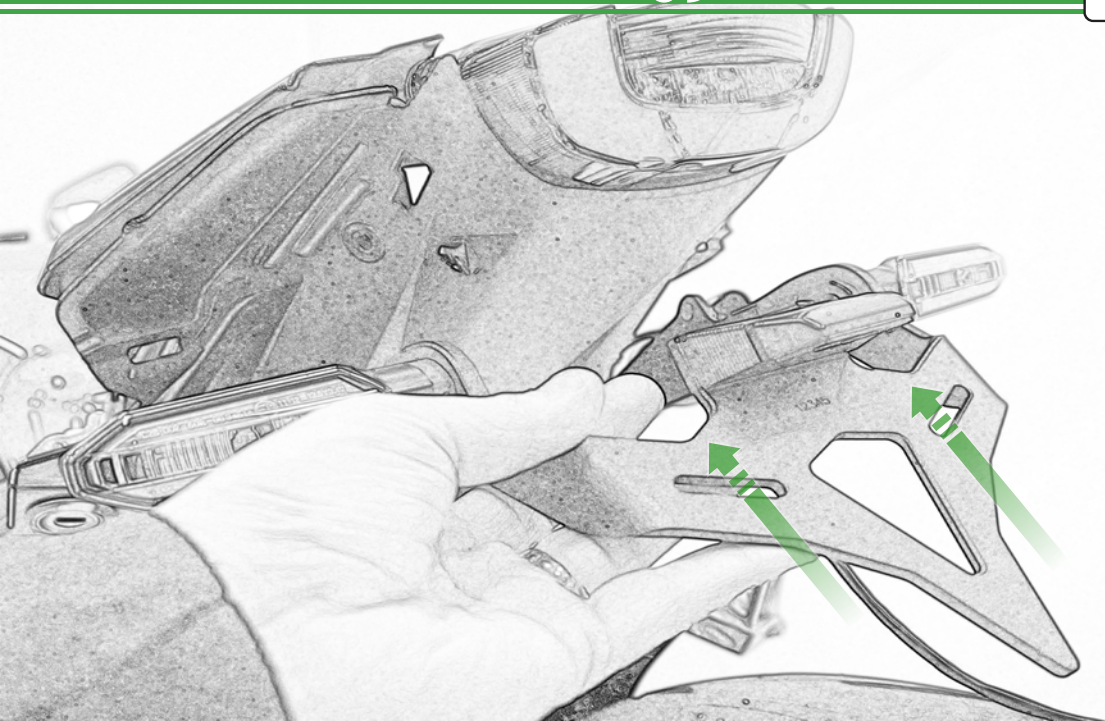



OEM PART

Repeat
Both Sides

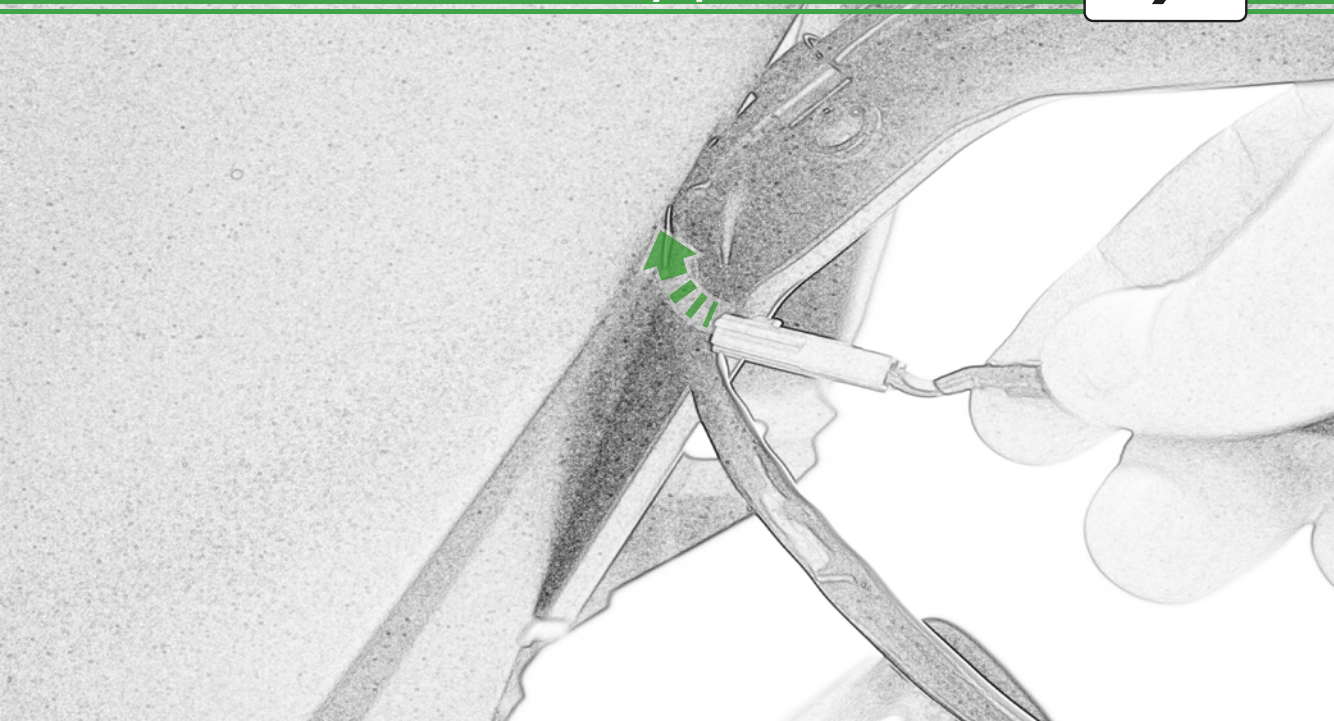



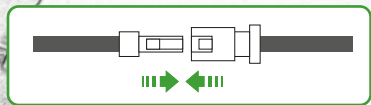
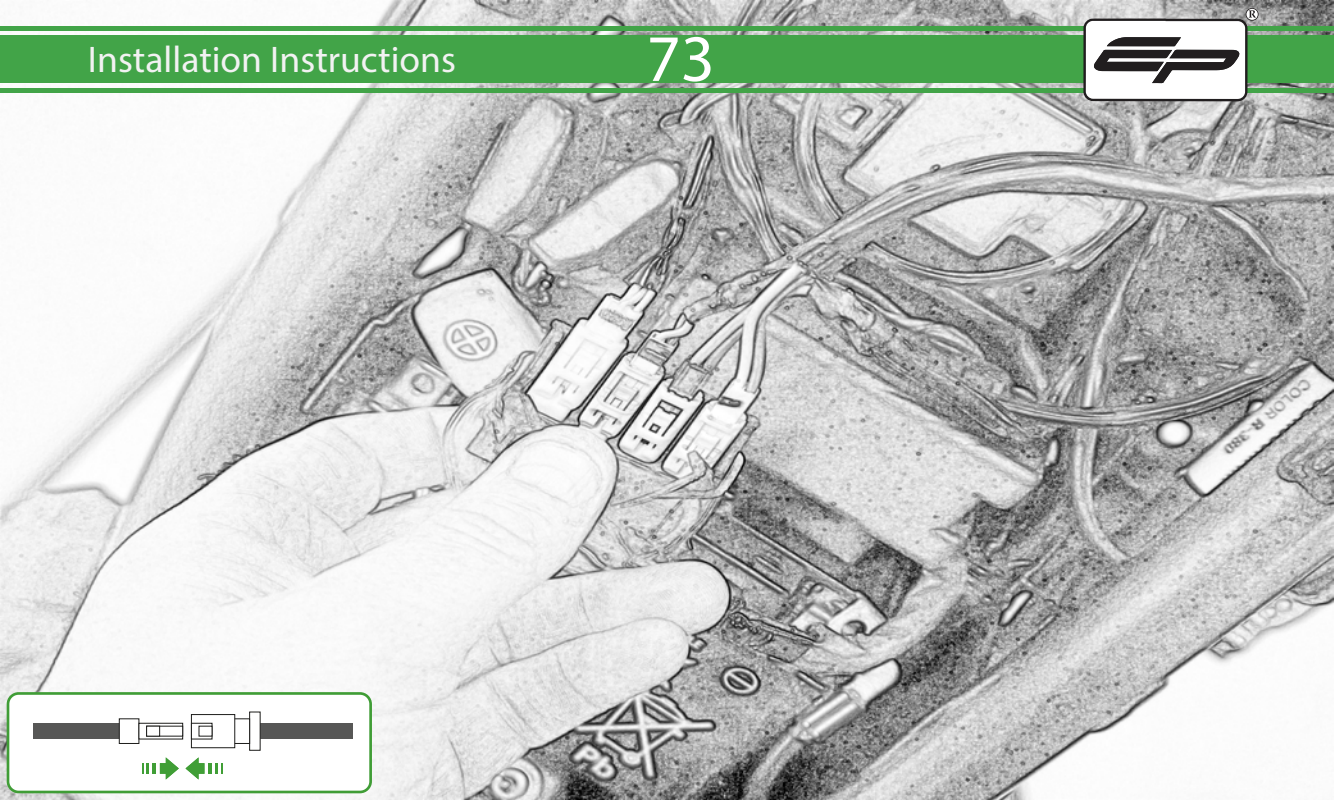

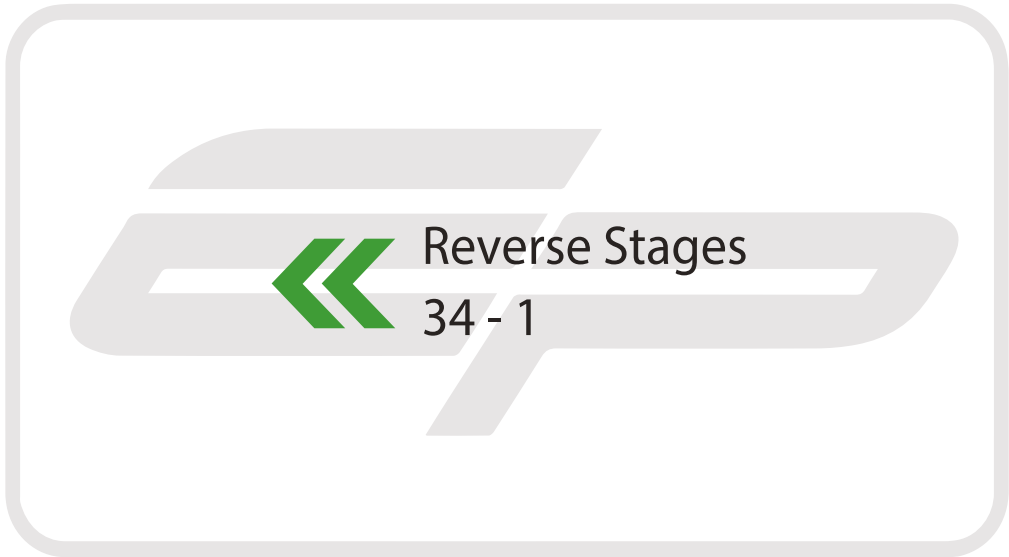

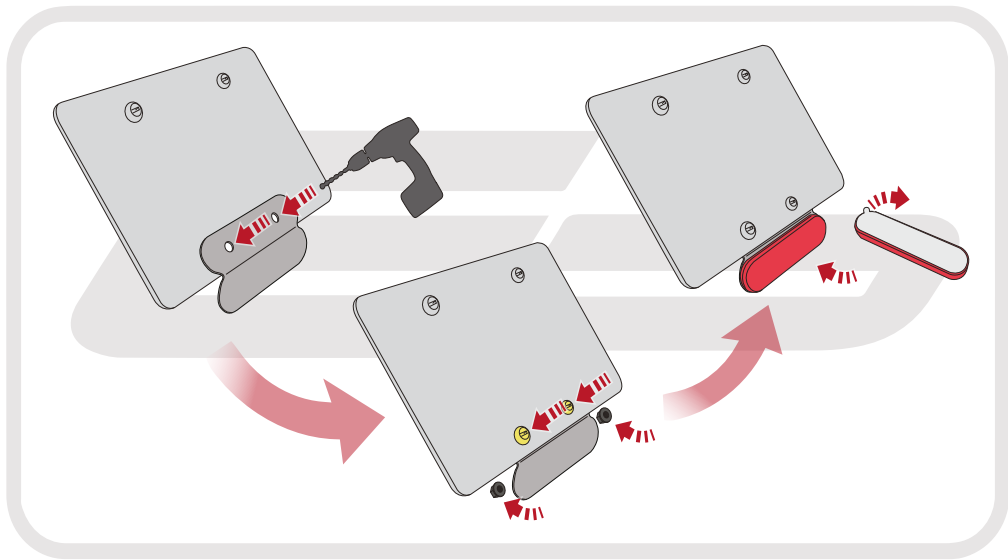

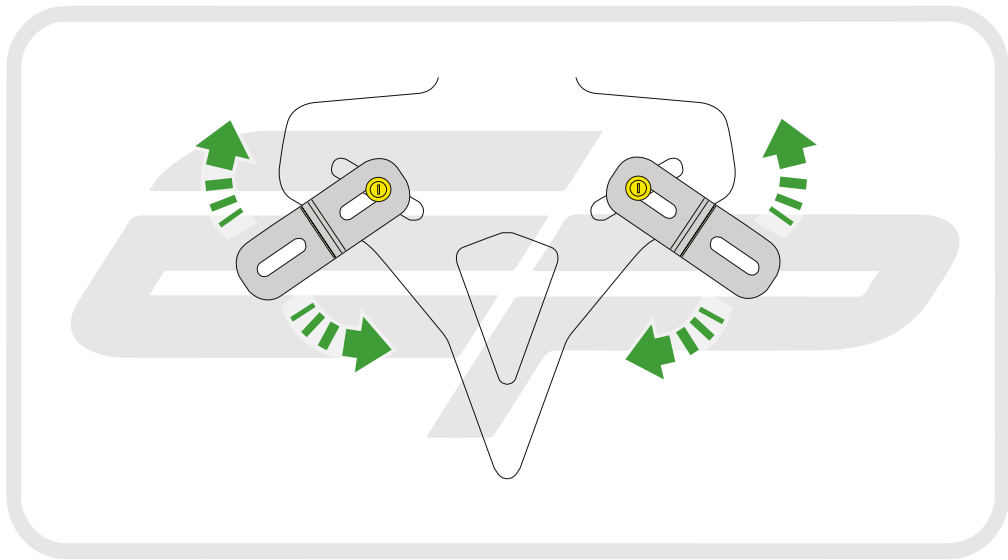



ESSENTIAL CHECKS

After installation of your tail tidy ensure that the licence plate does not contact the rear tyre when suspension is fully compressed.

Ensure all electrics including indicators, tail light, brake light and licence plate light lights are working correctly before riding the motorcycle.

It is recommended that periodic inspections are made to ensure that all fixings are fully tightend.



EVOTECH®
P E R F O R M A N C E

www.evotech-performance.com