



**EVOTECH**®  
P E R F O R M A N C E

[www.evotech-performance.com](http://www.evotech-performance.com)

Triumph Trident Tail Tidy  
Installation Instructions



## Kit Contents PRN015396

- (A) 1 x BMW Light
- (B) 1 x Connector Type 23
- (C) 1 x Connector Type 25
- (D) 1 x M8 x 20mm Button Head Bolts
- (E) 1 x M5 x 16mm Button Head Bolts
- (F) 1 x M5 Washer
- (G) 1 x Back Spacer
- (H) 1 x Front Spacer
- (I) 1 x Support Bracket
- (J) 1 x Number Plate Bracket
- (K) 1 x Main Right Body
- (L) 1 x Main Left Body
- (M) 2 x M6 Flange Nut
- (N) 6 x M6 x 16 Button Head Bolts

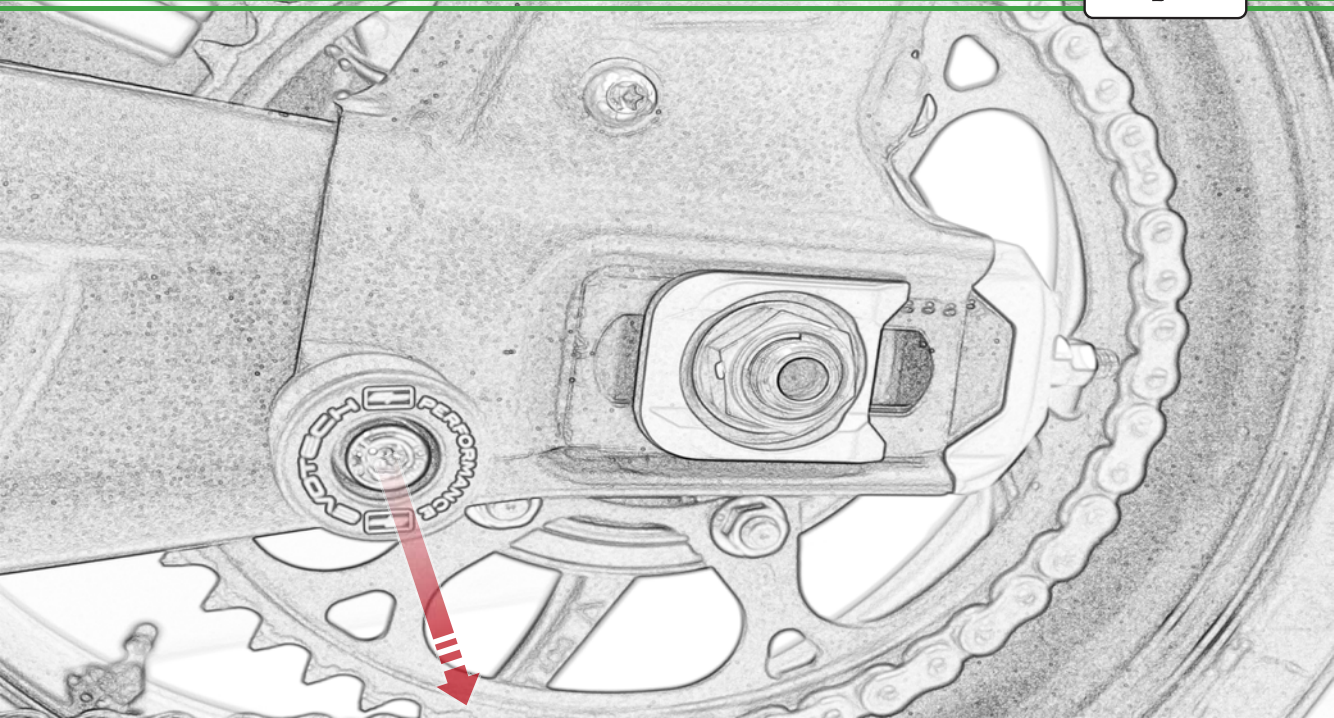

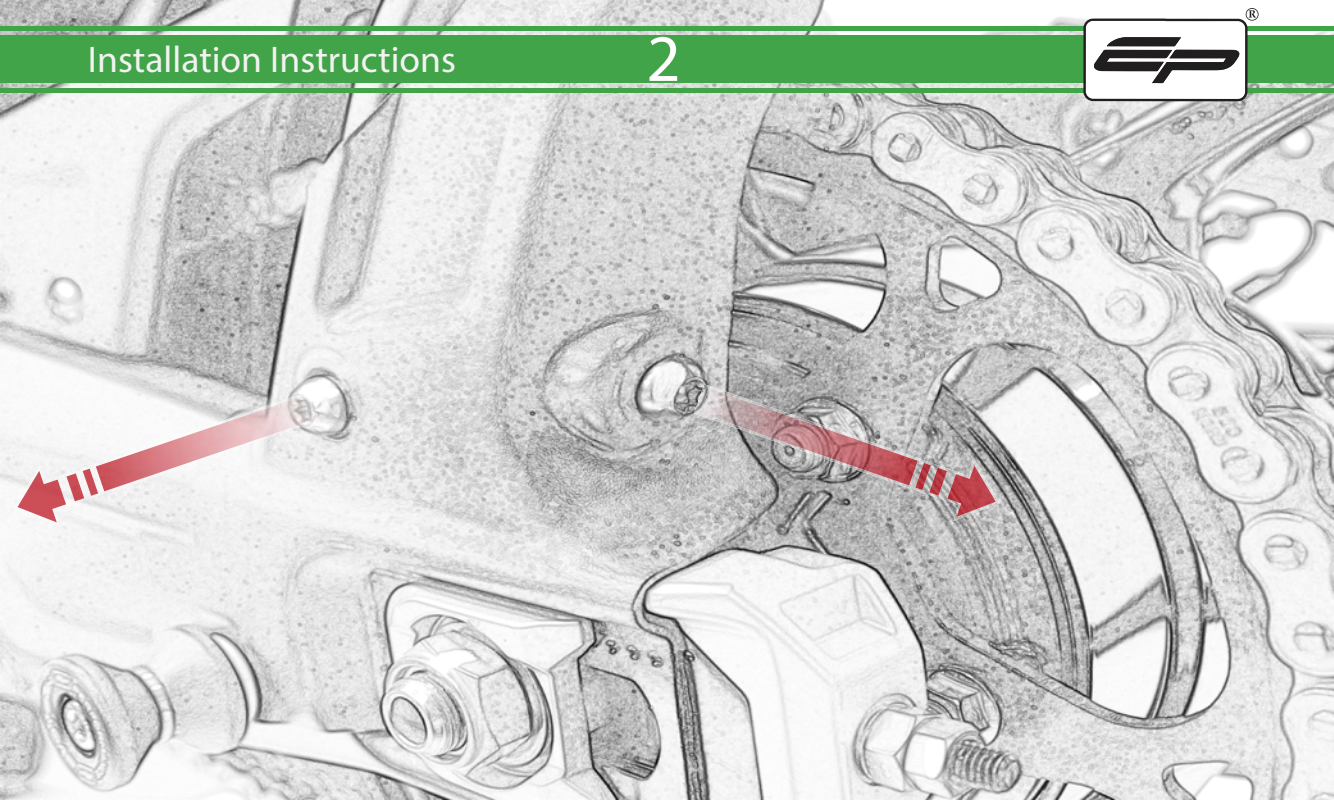





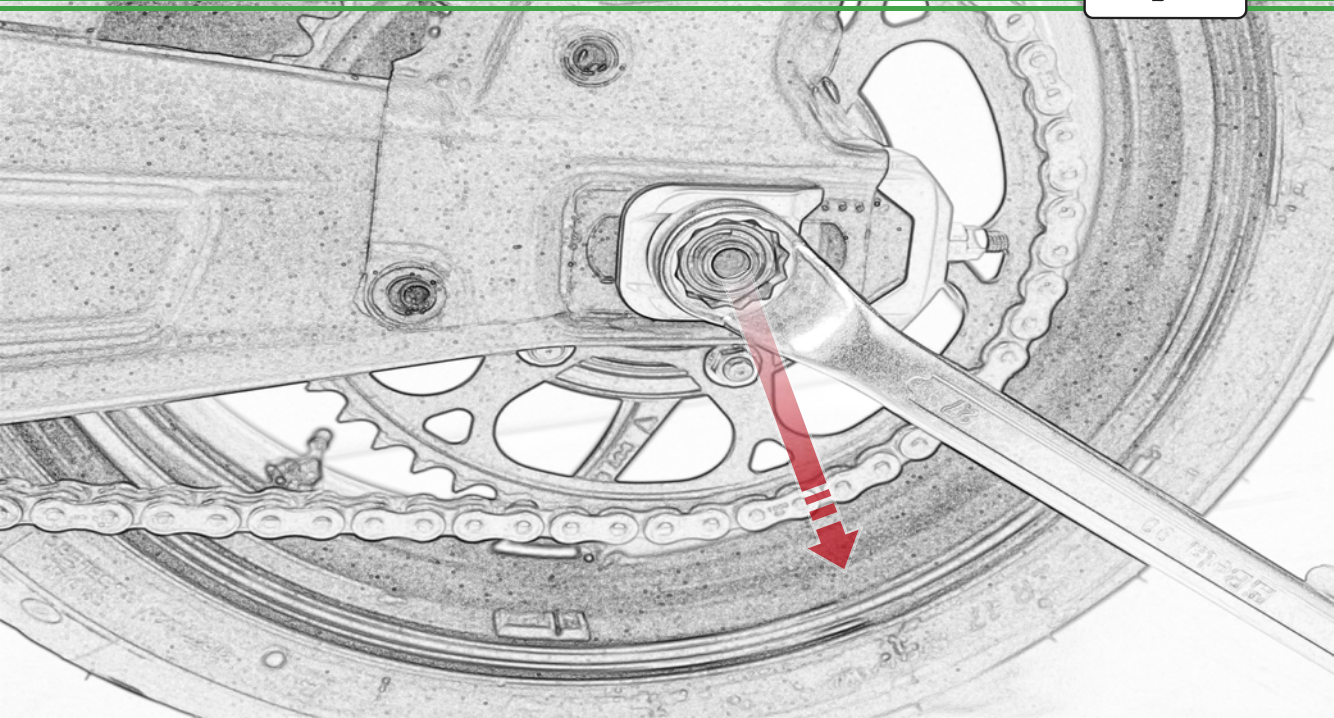

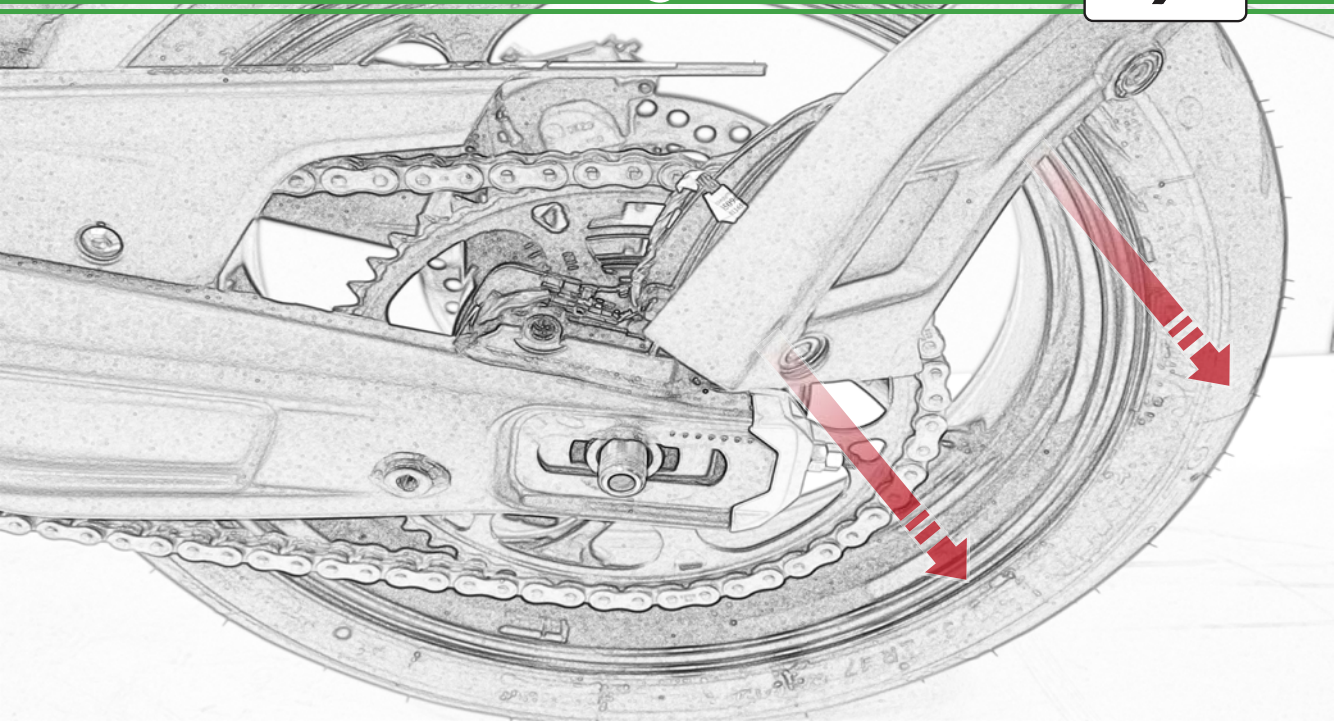



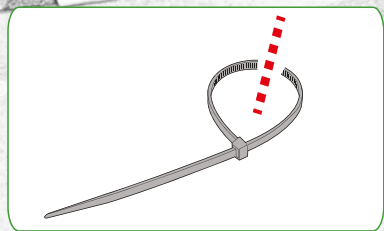
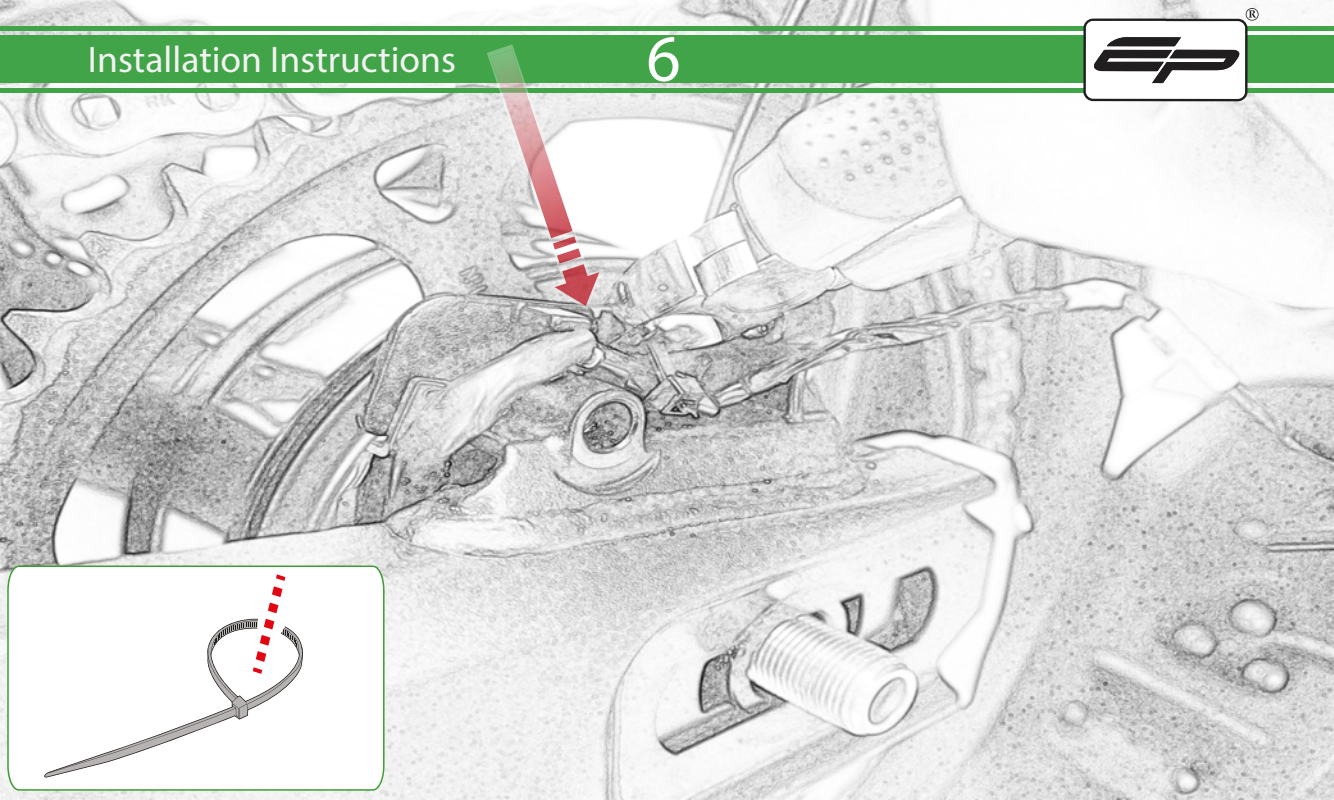

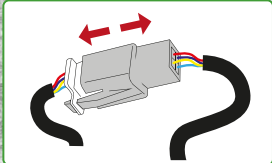
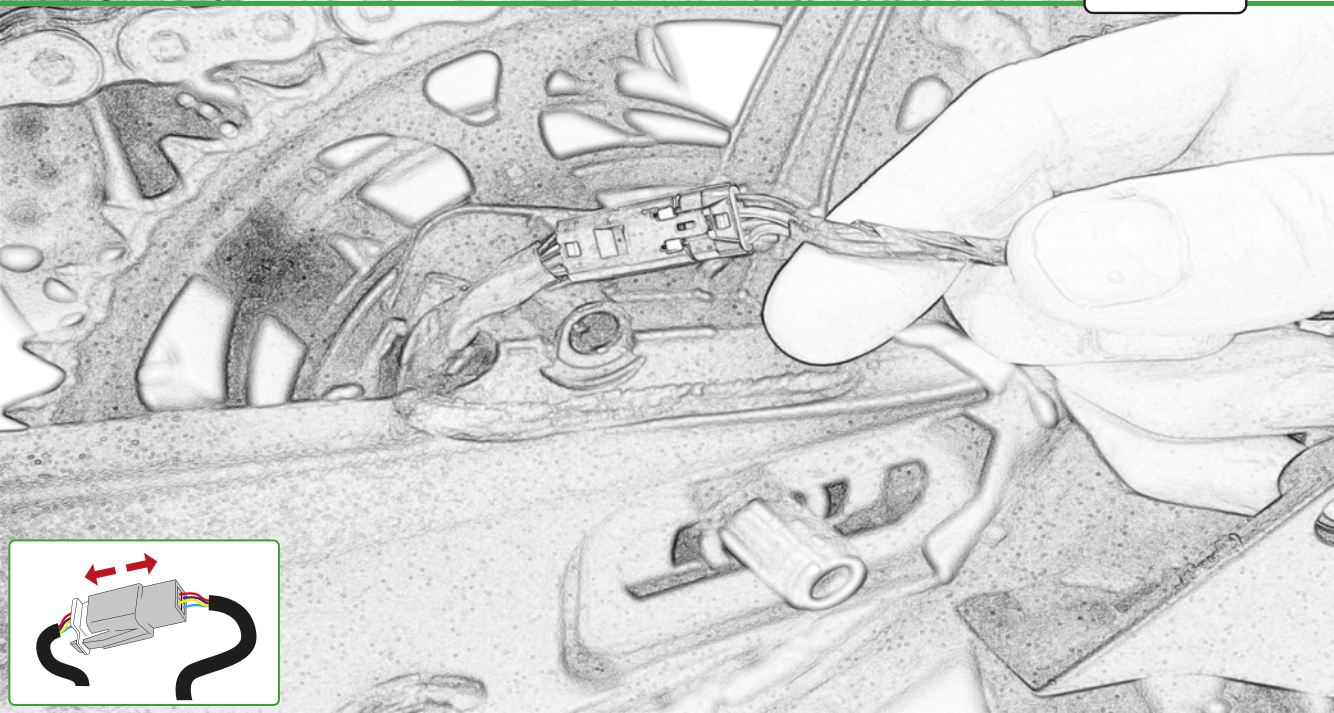

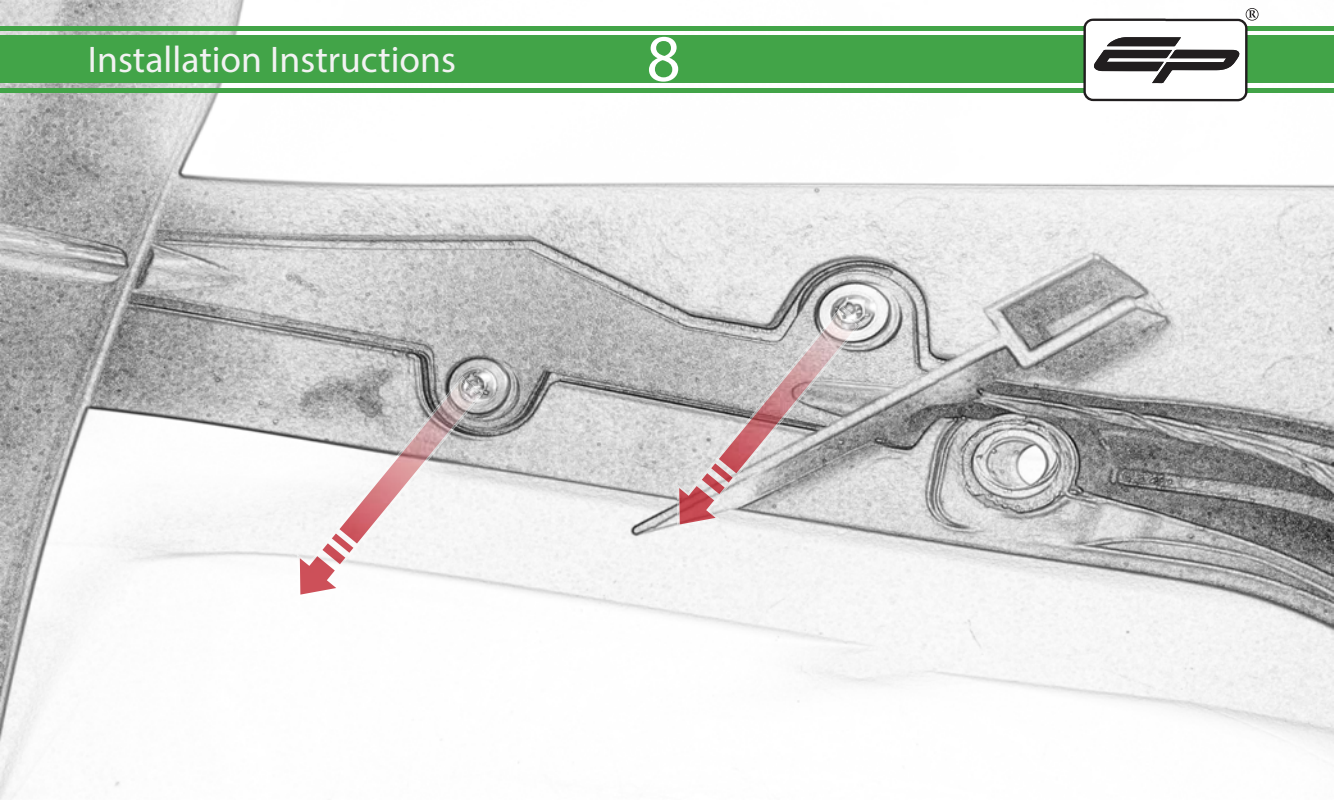



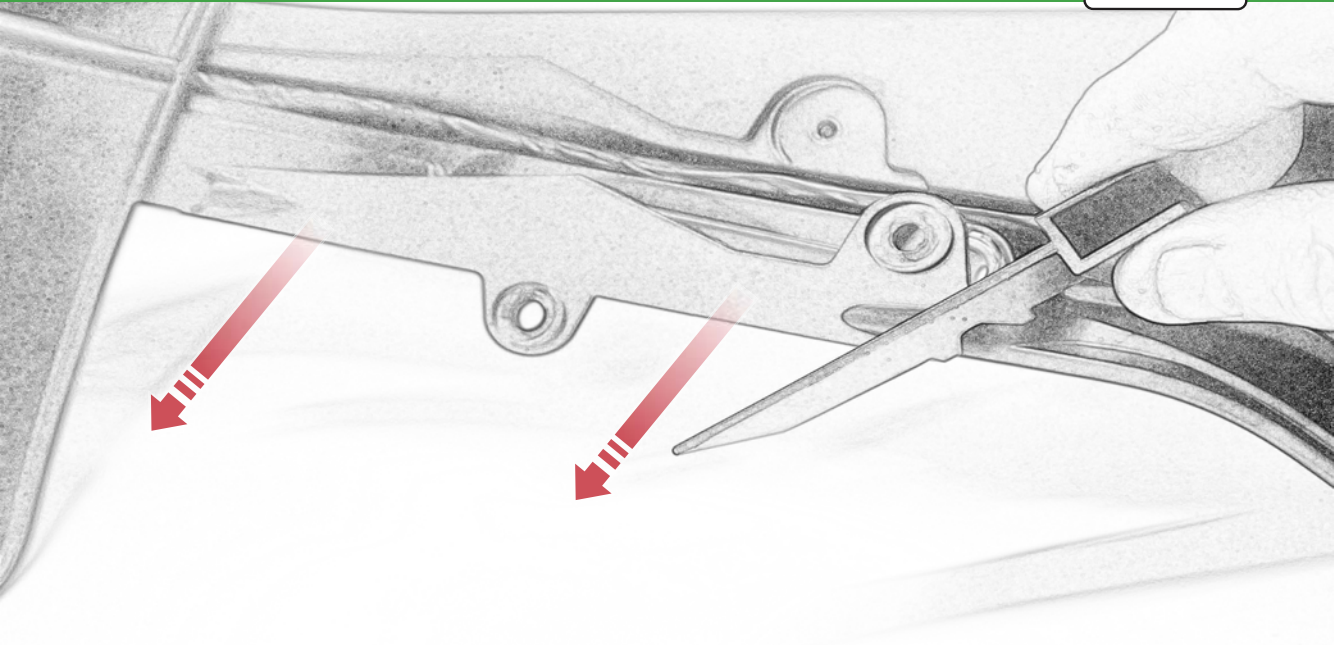

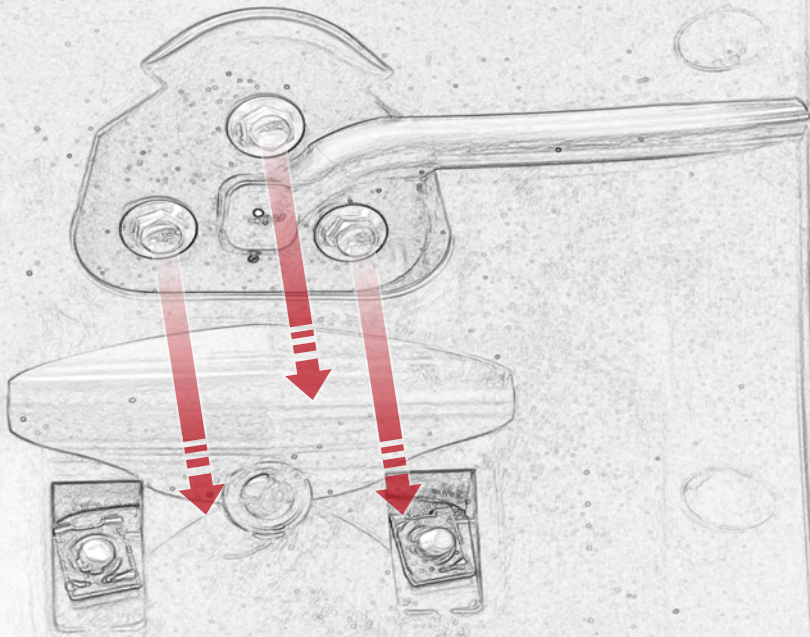

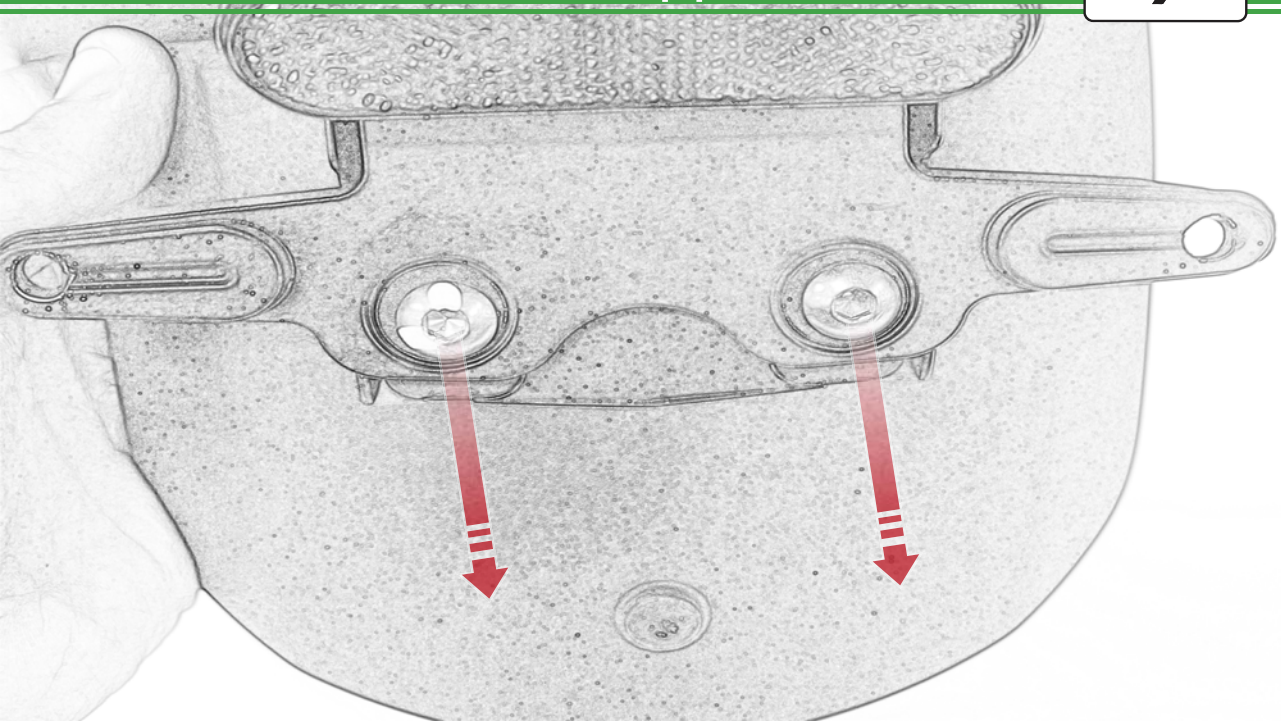

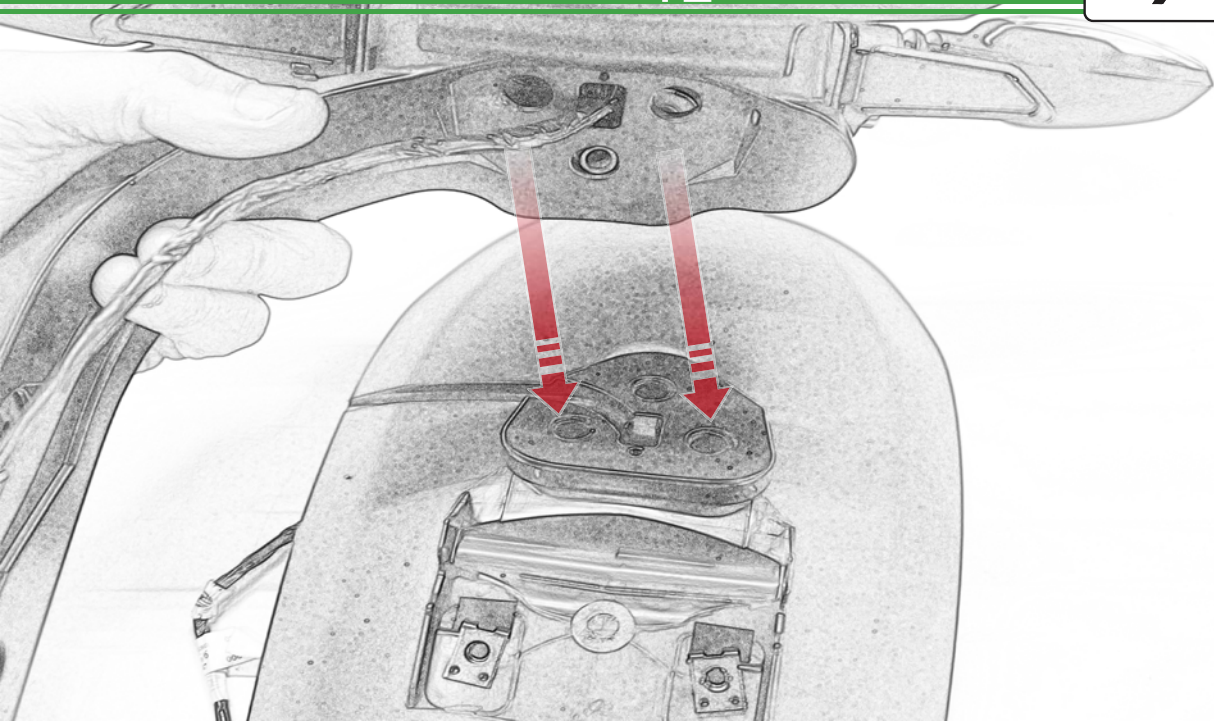

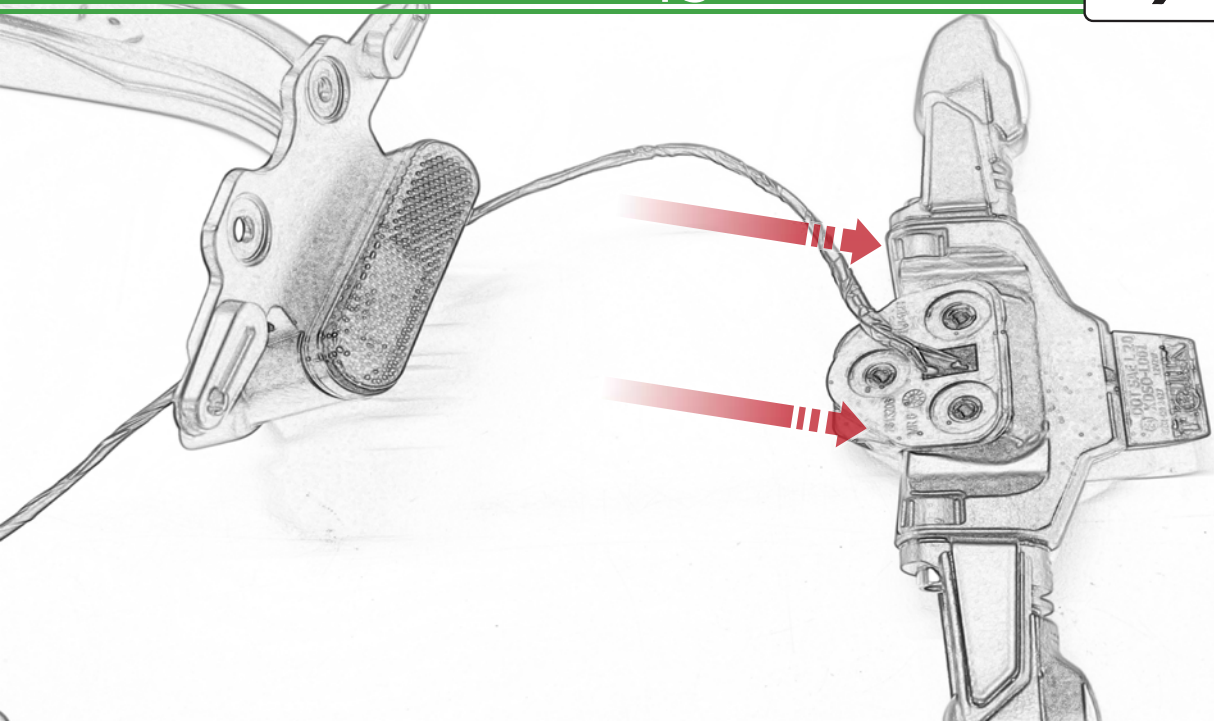



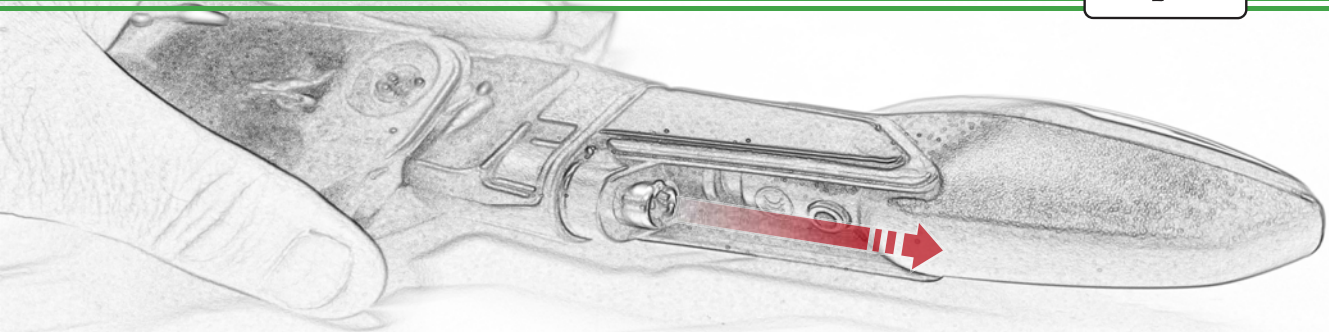

Repeat  
Both Sides



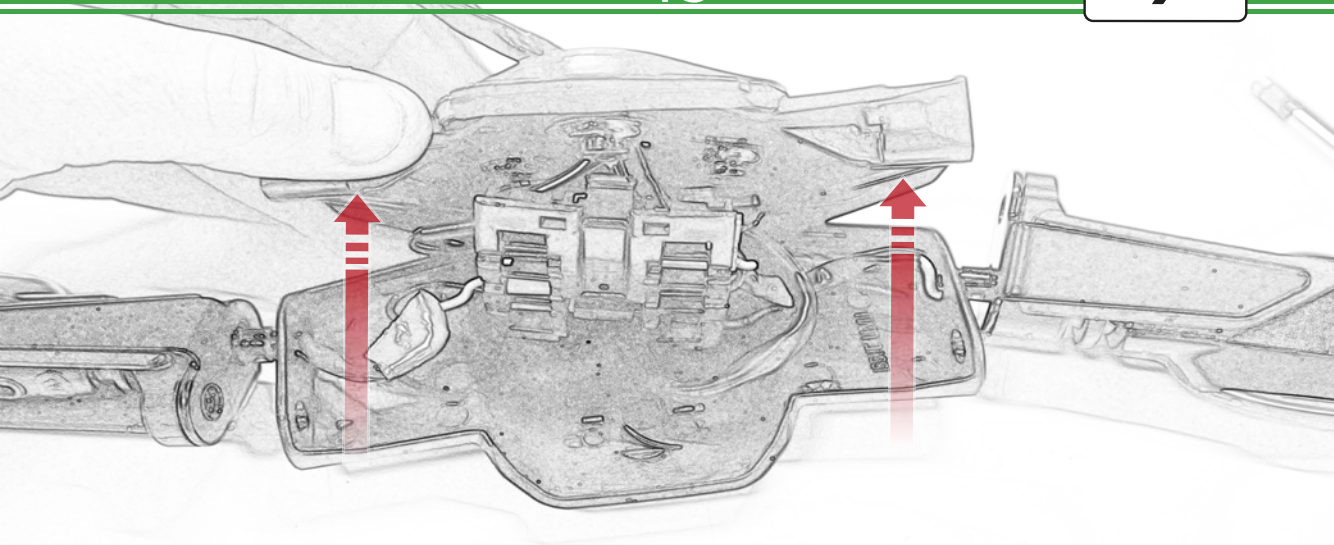

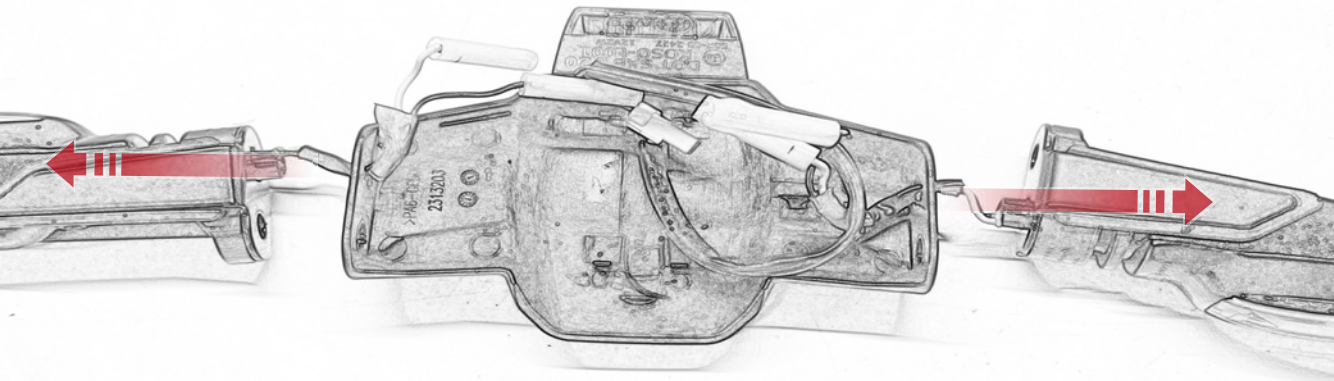

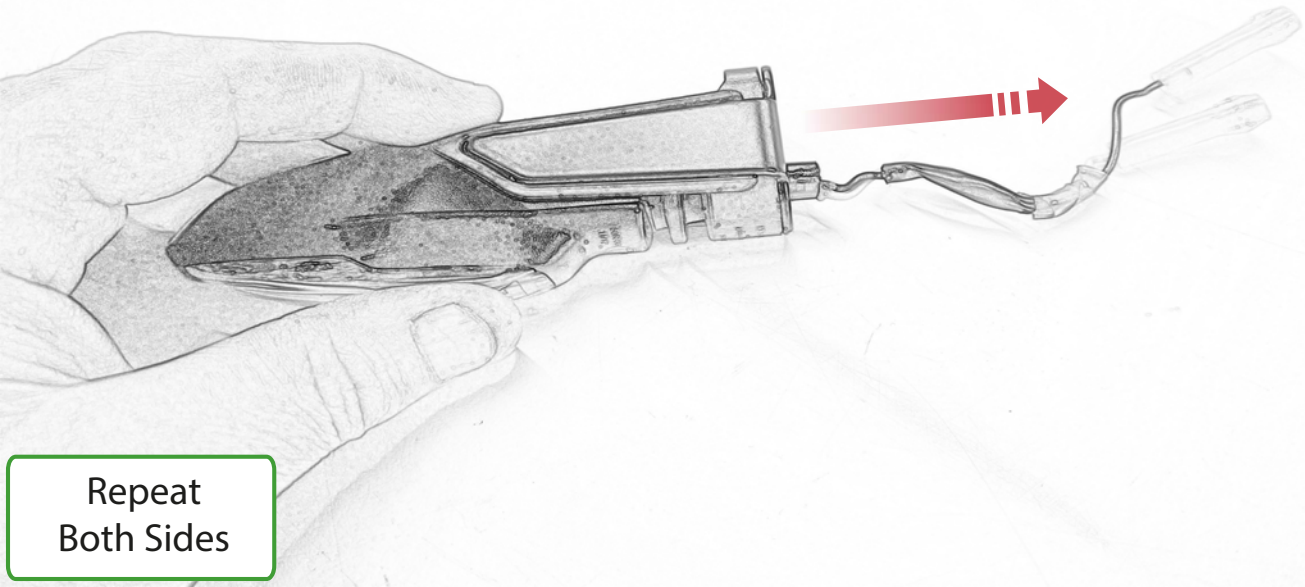

Repeat  
Both Sides

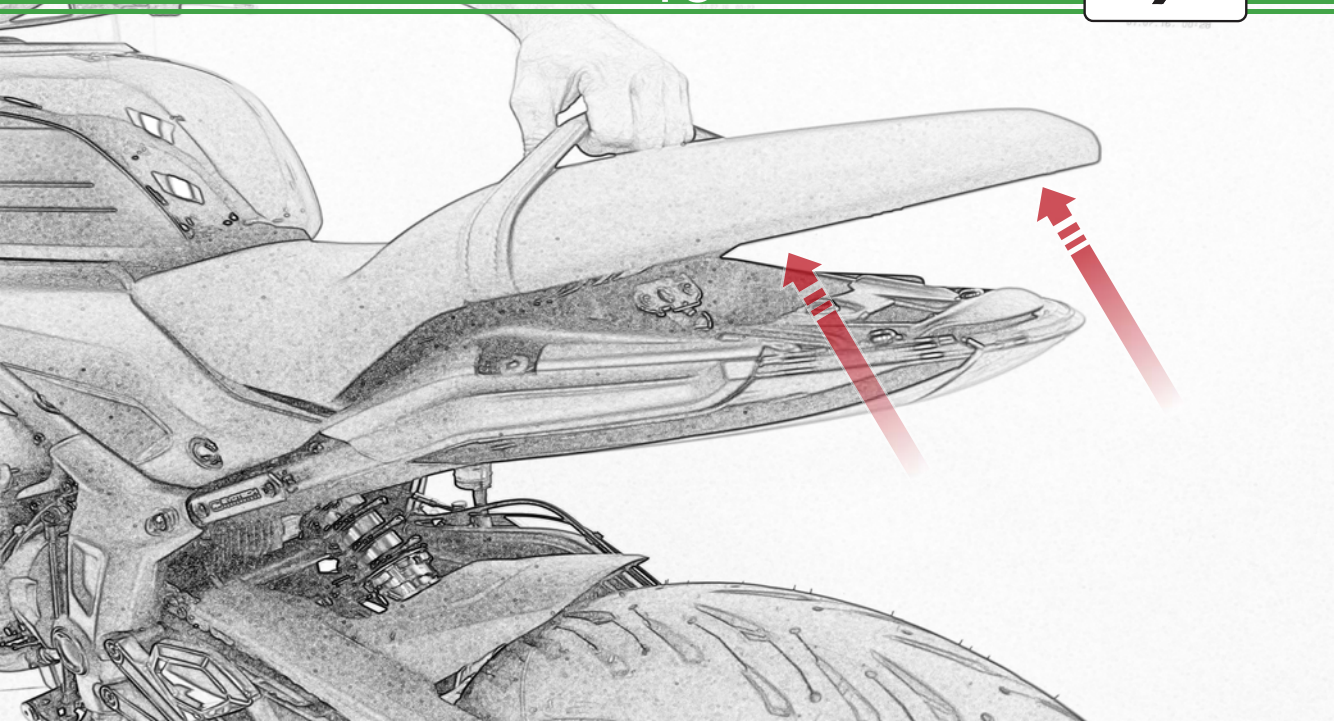

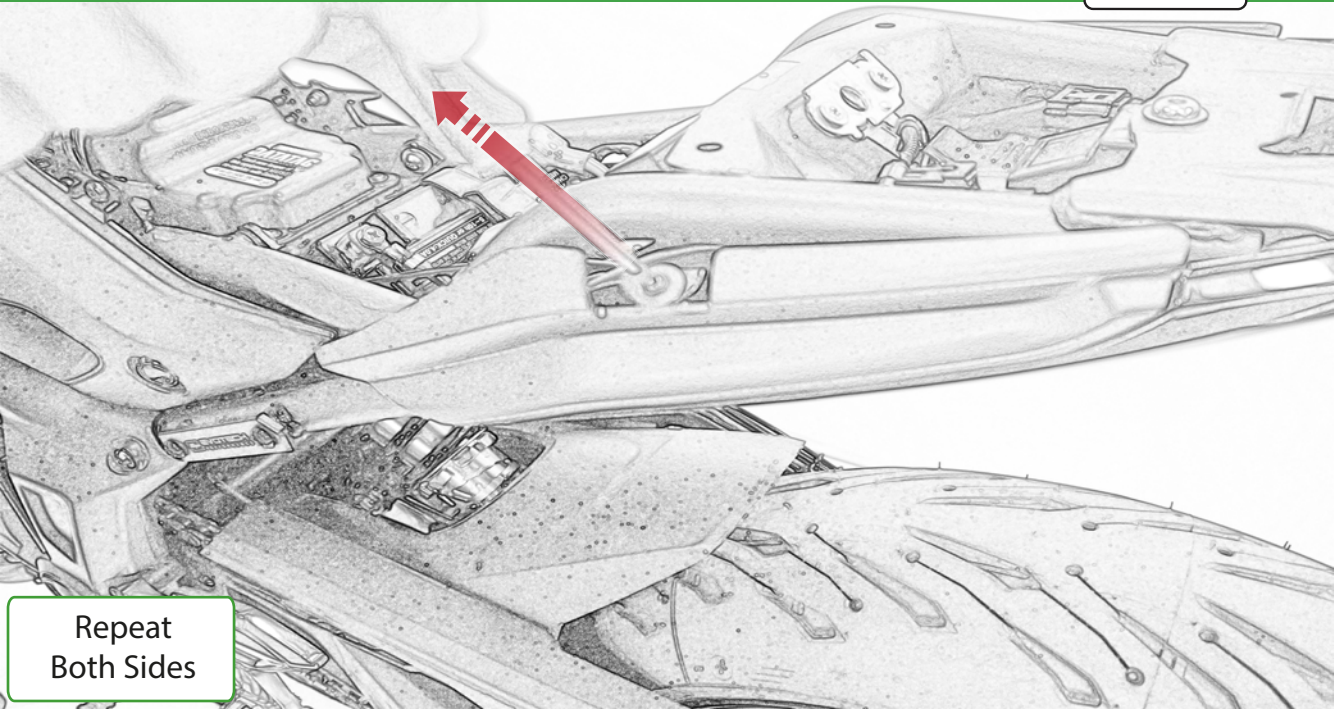

Repeat  
Both Sides



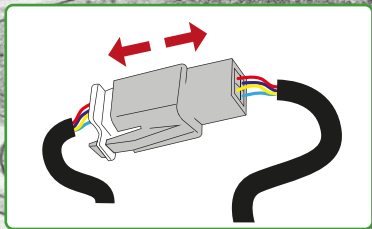
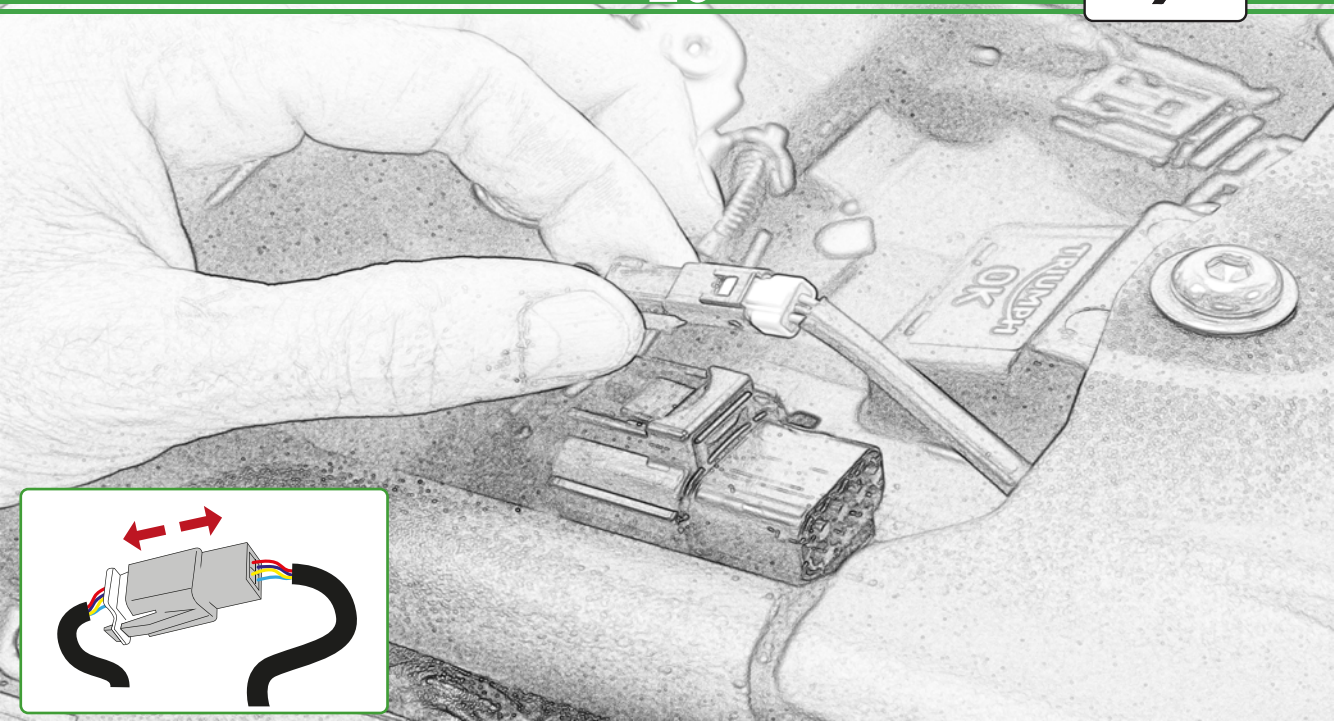



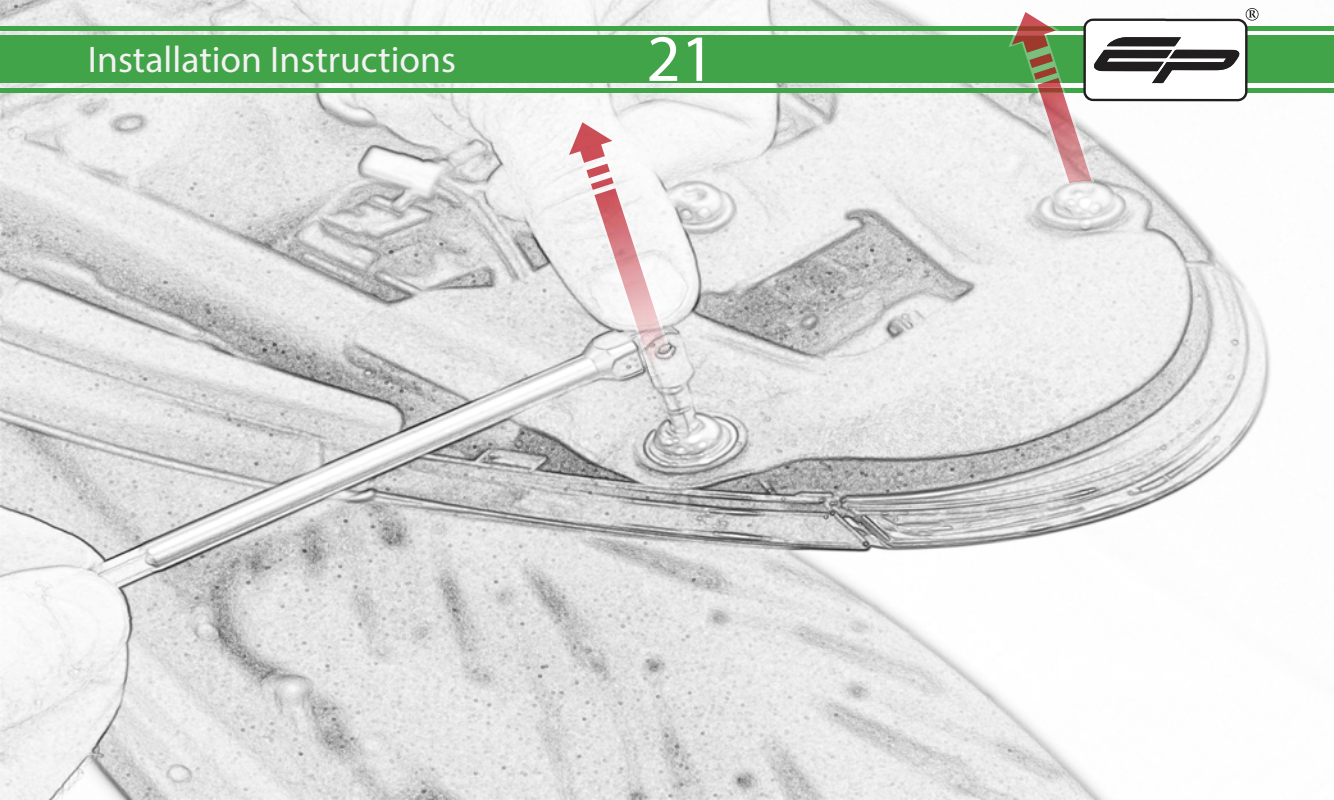

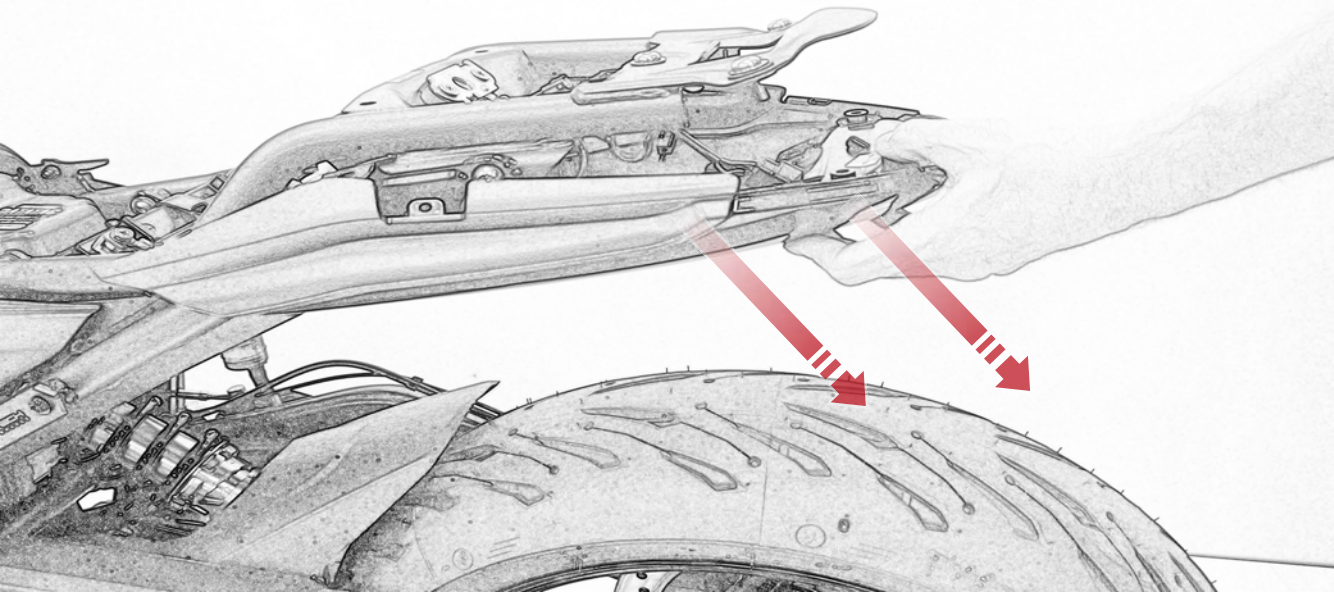

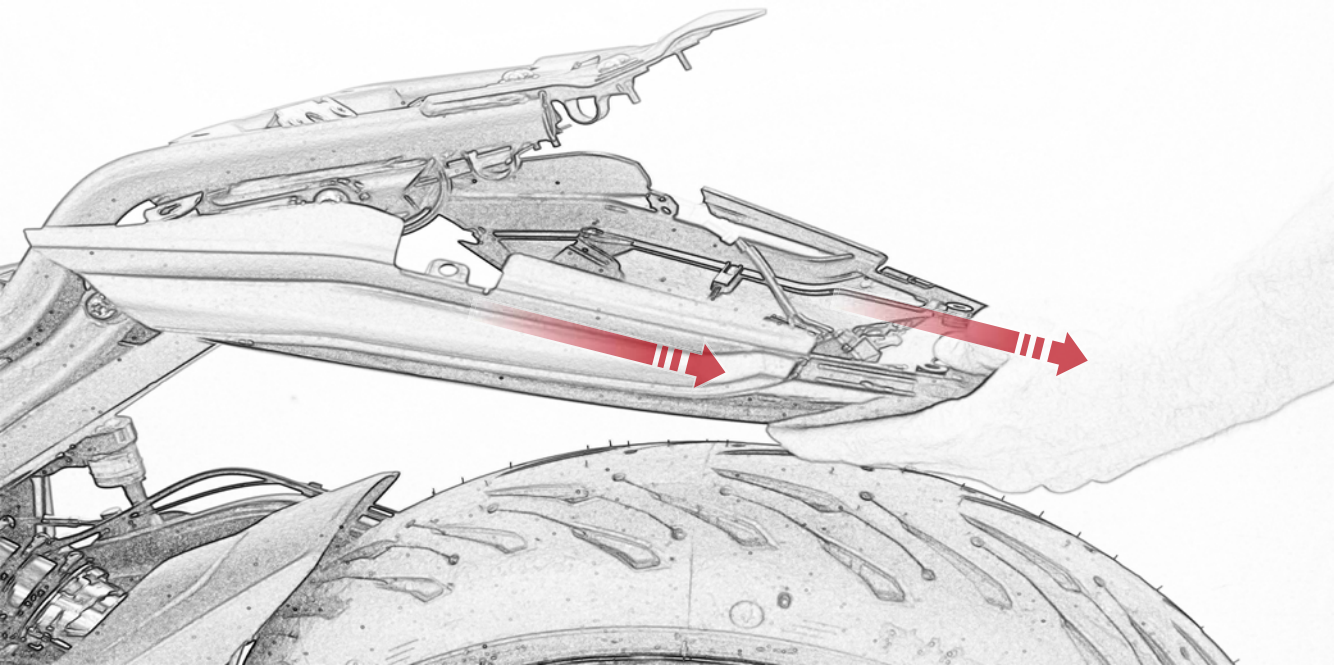



Release  
Tab



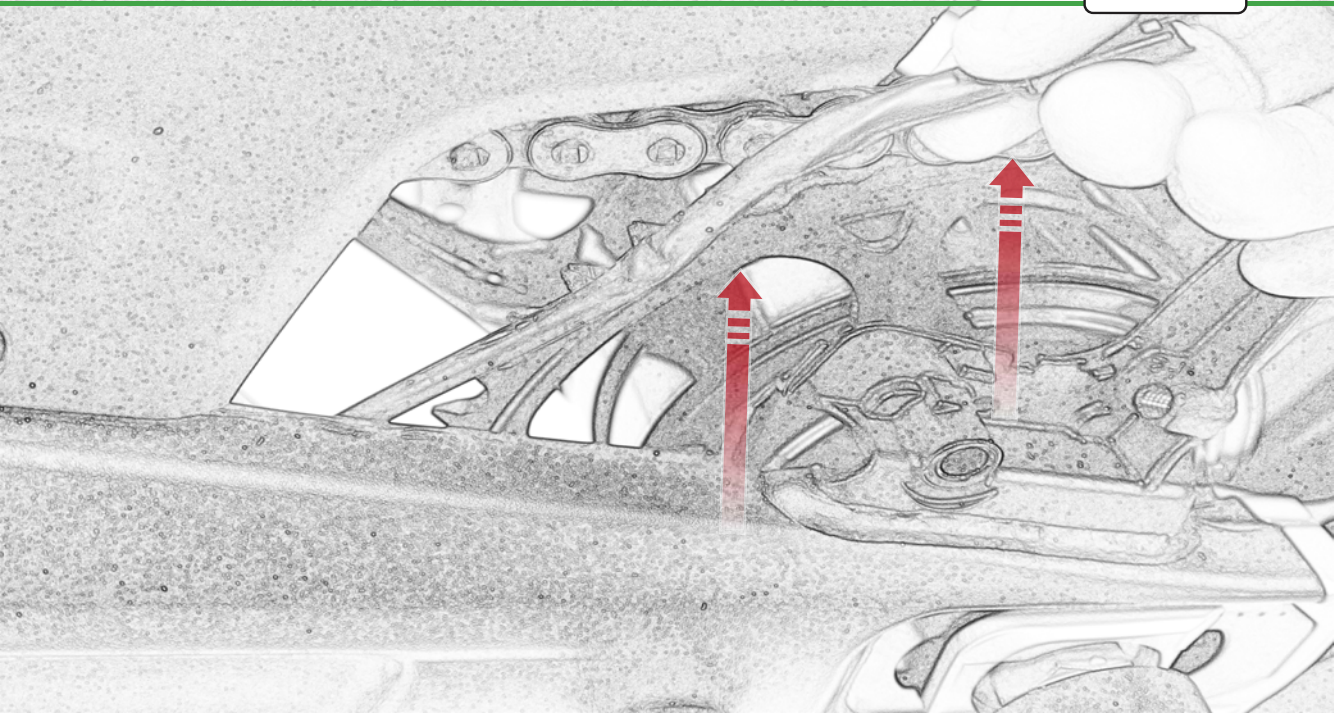

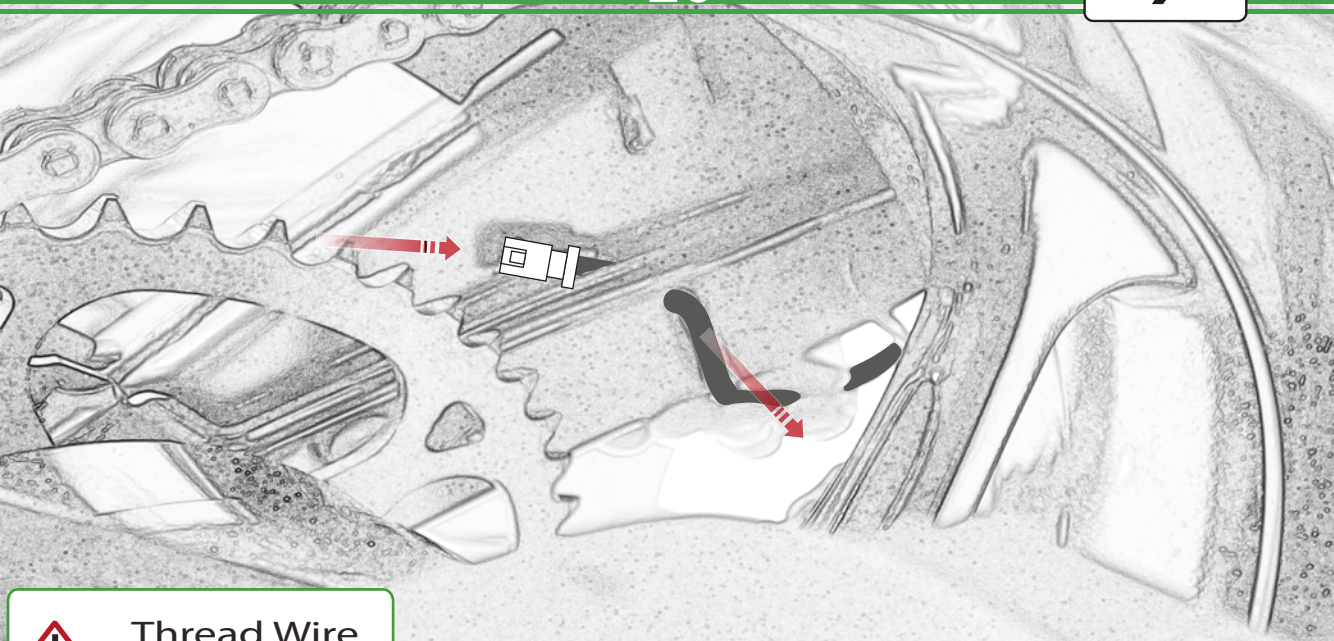

Caution

Thread Wire  
Behind Cover



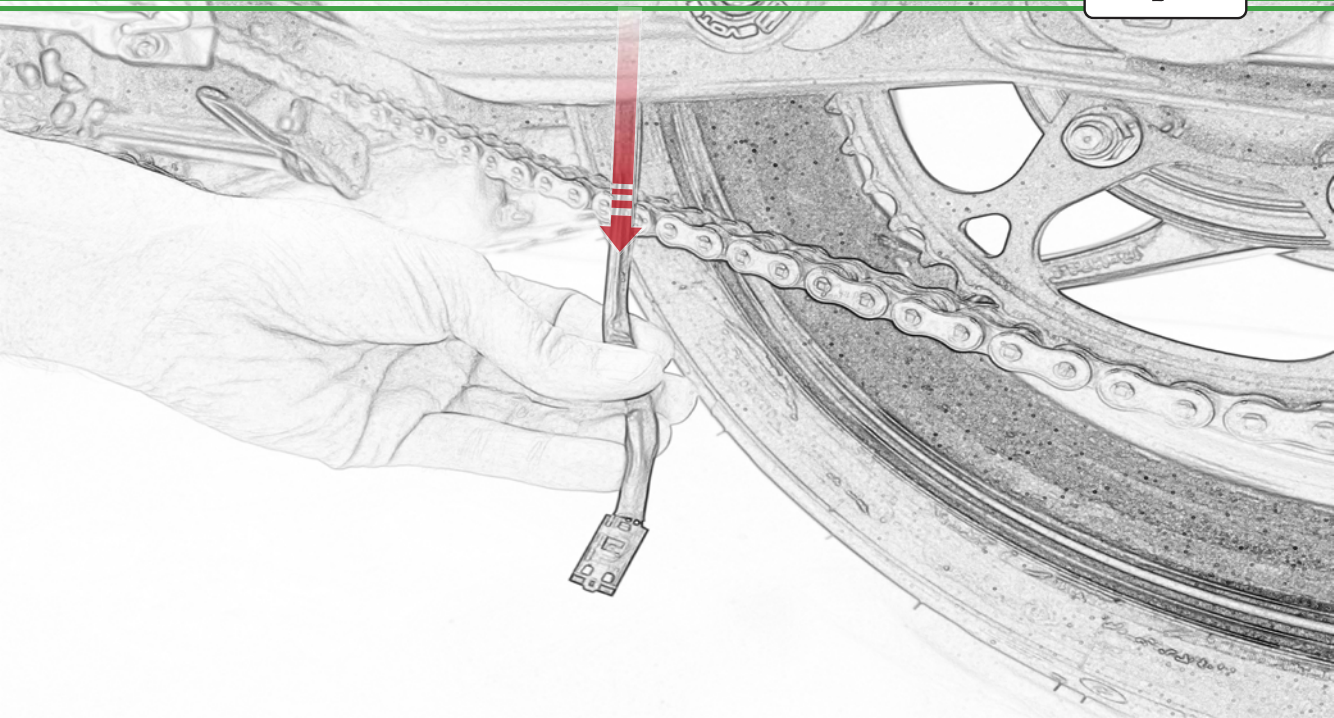

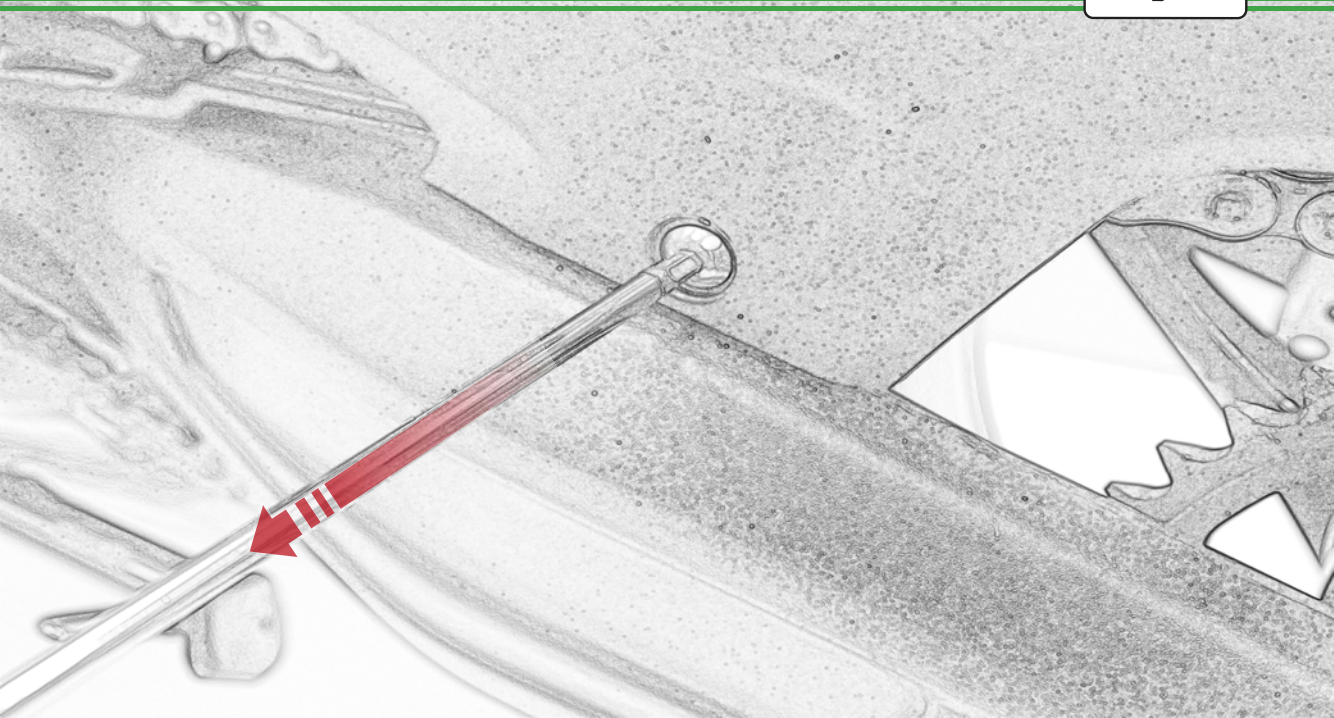

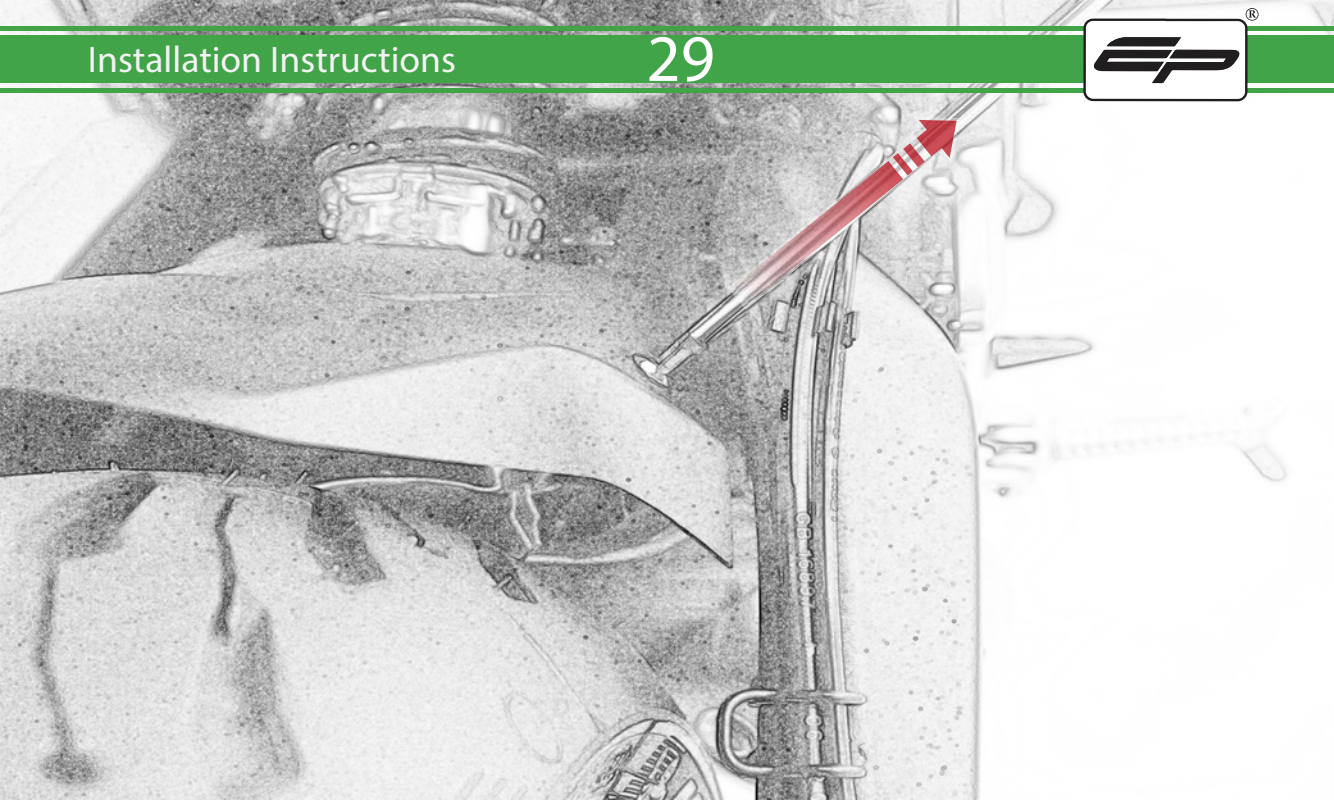

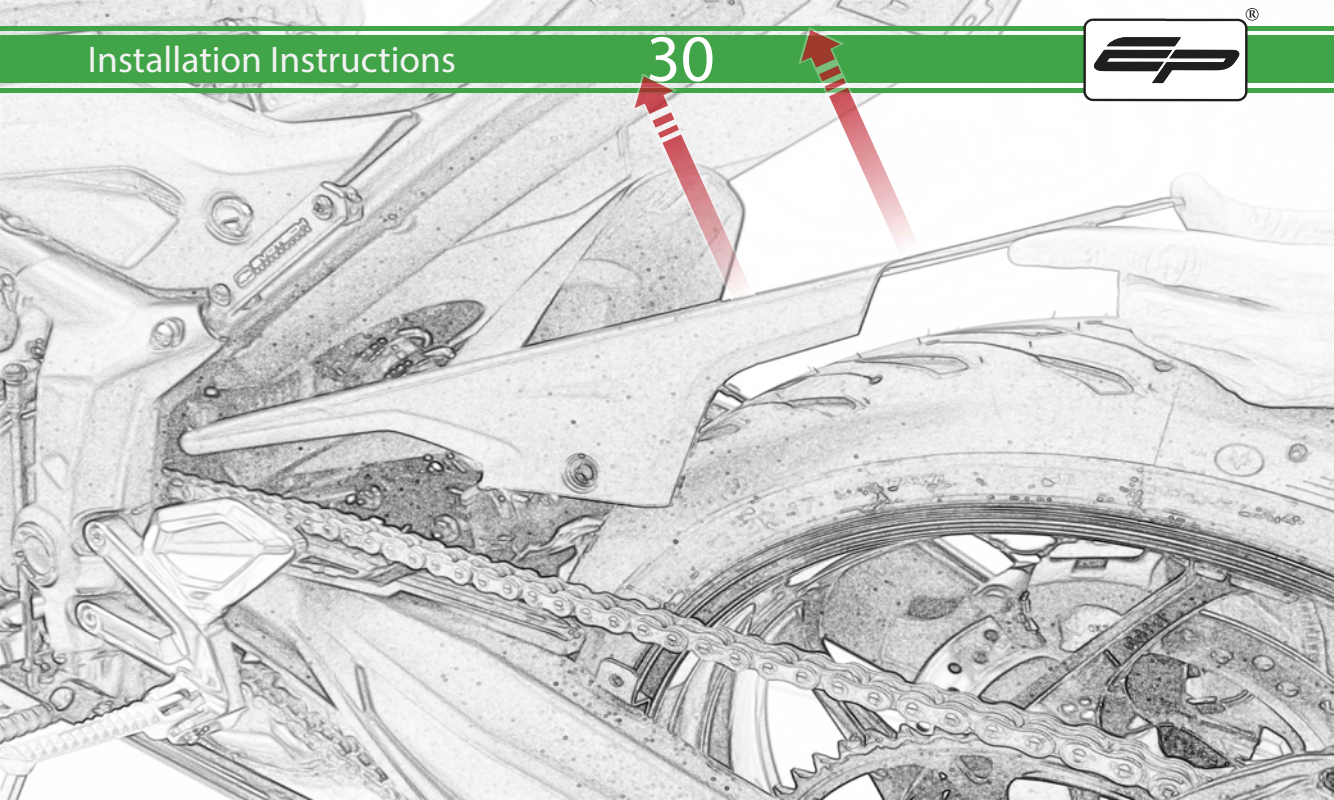



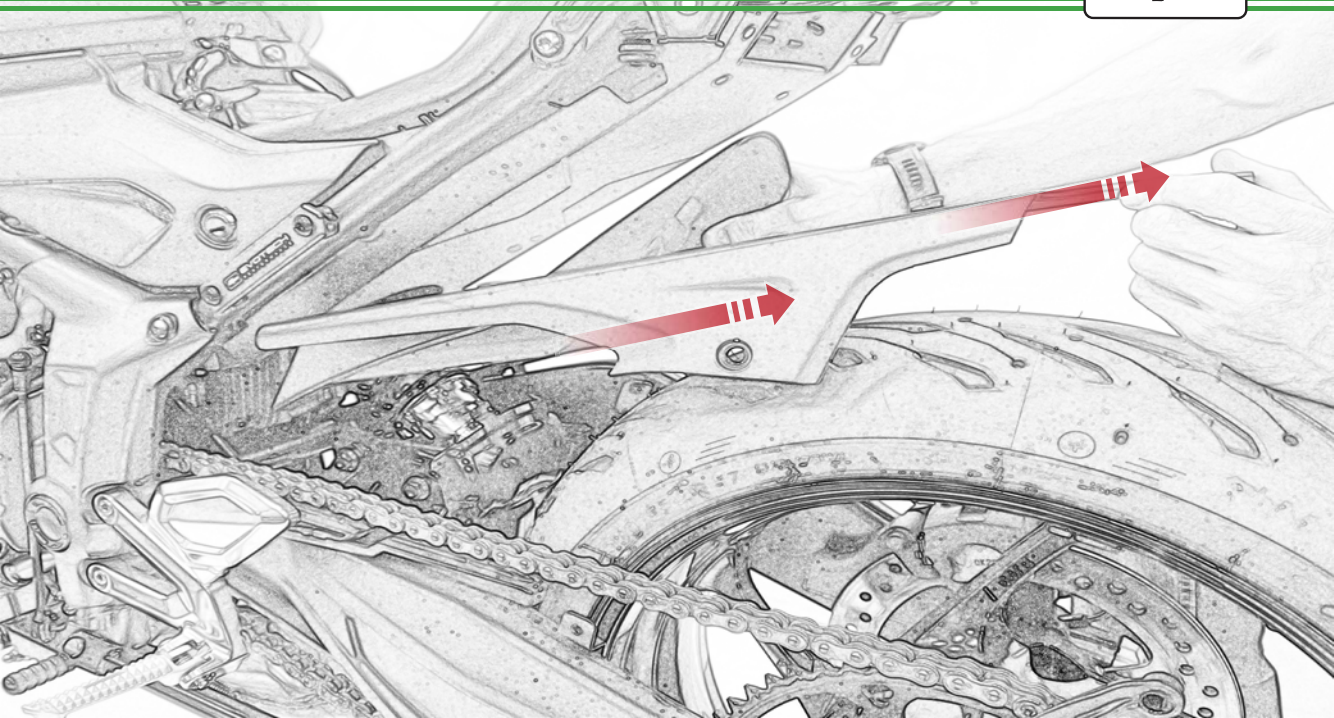



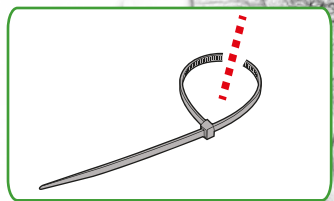
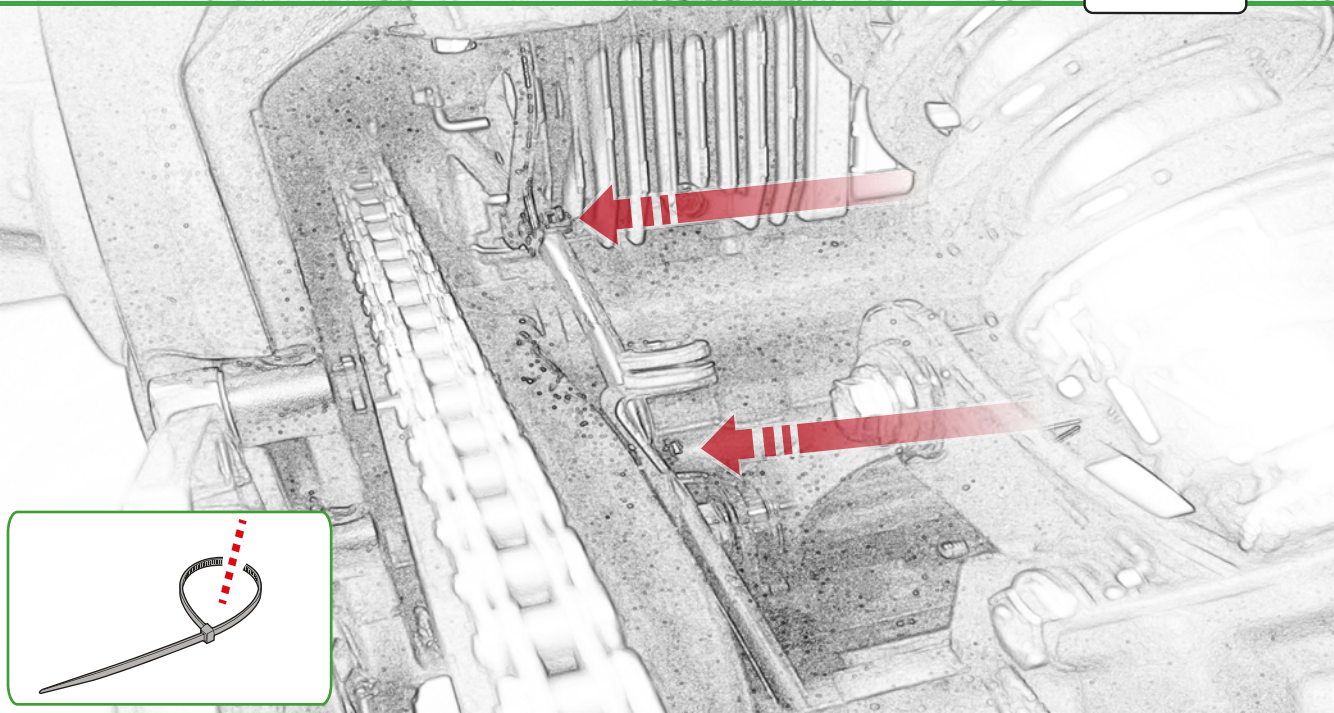

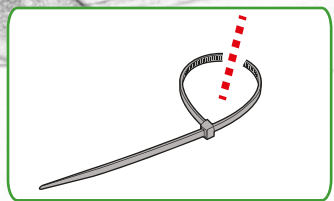
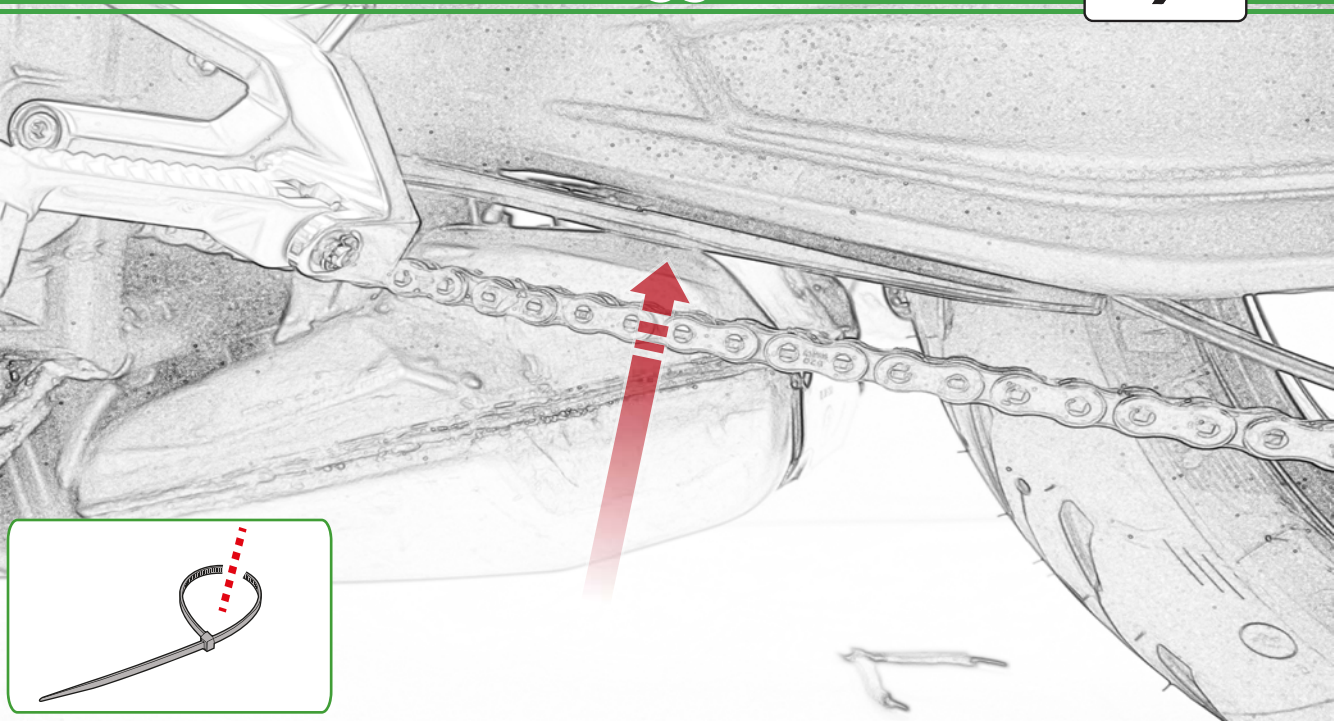

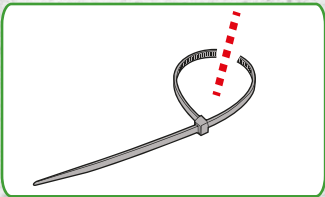
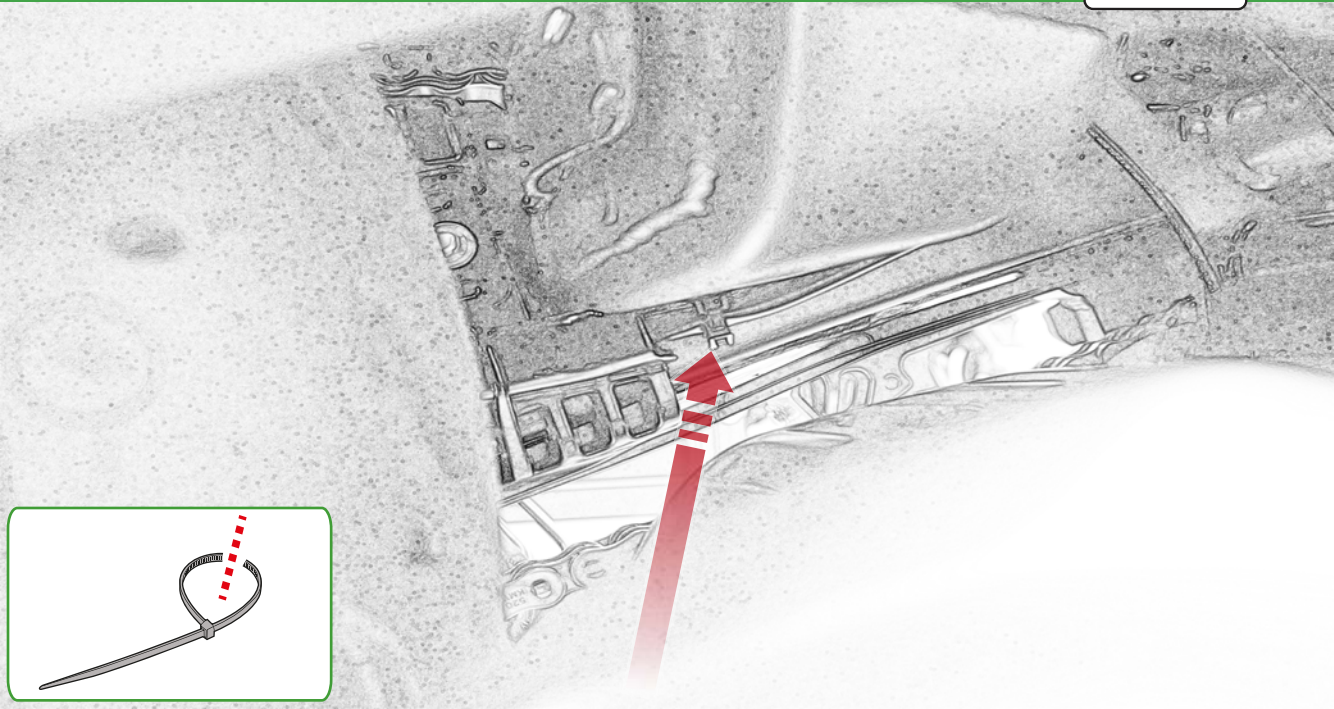

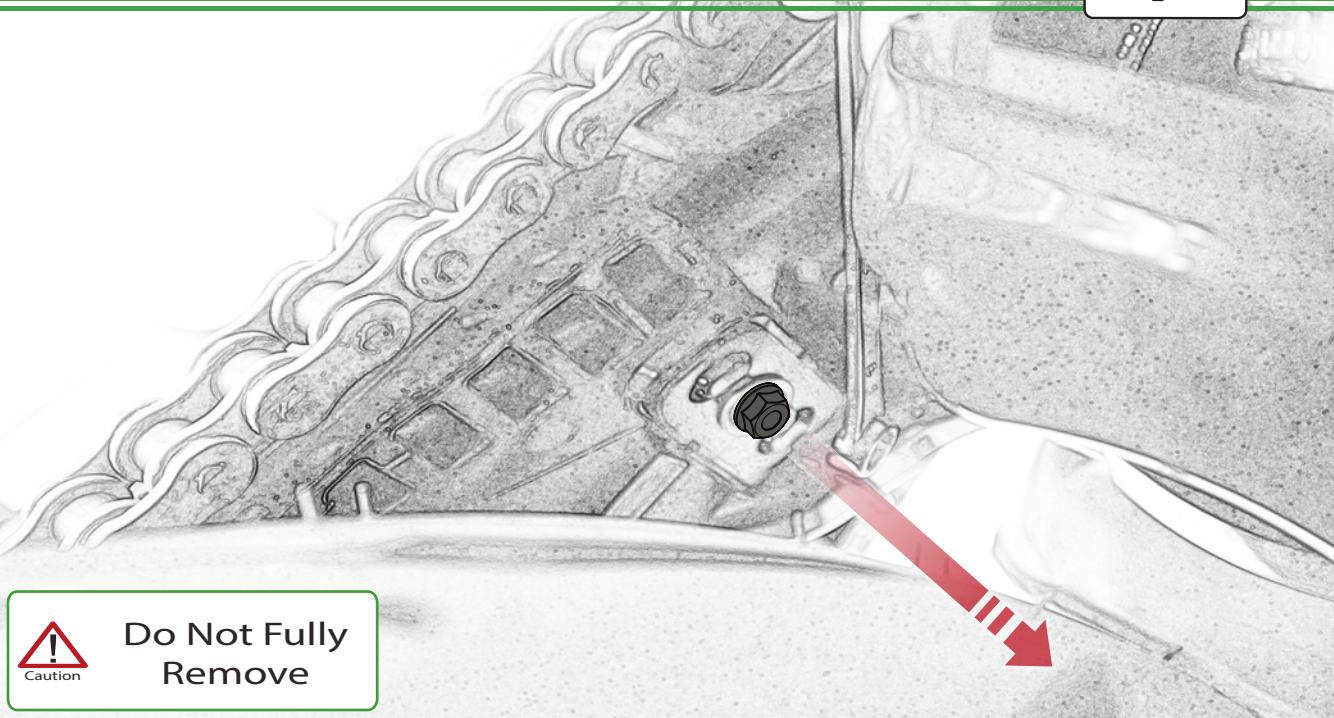

Caution

Do Not Fully  
Remove



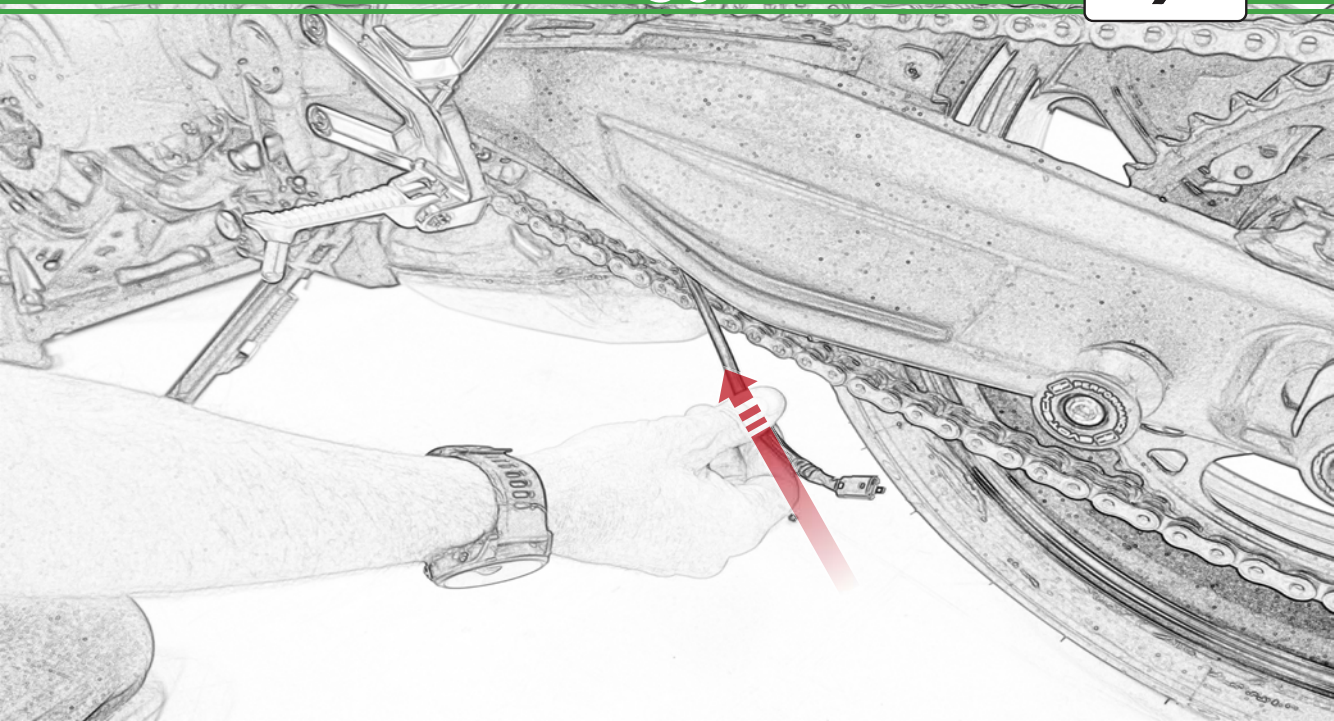



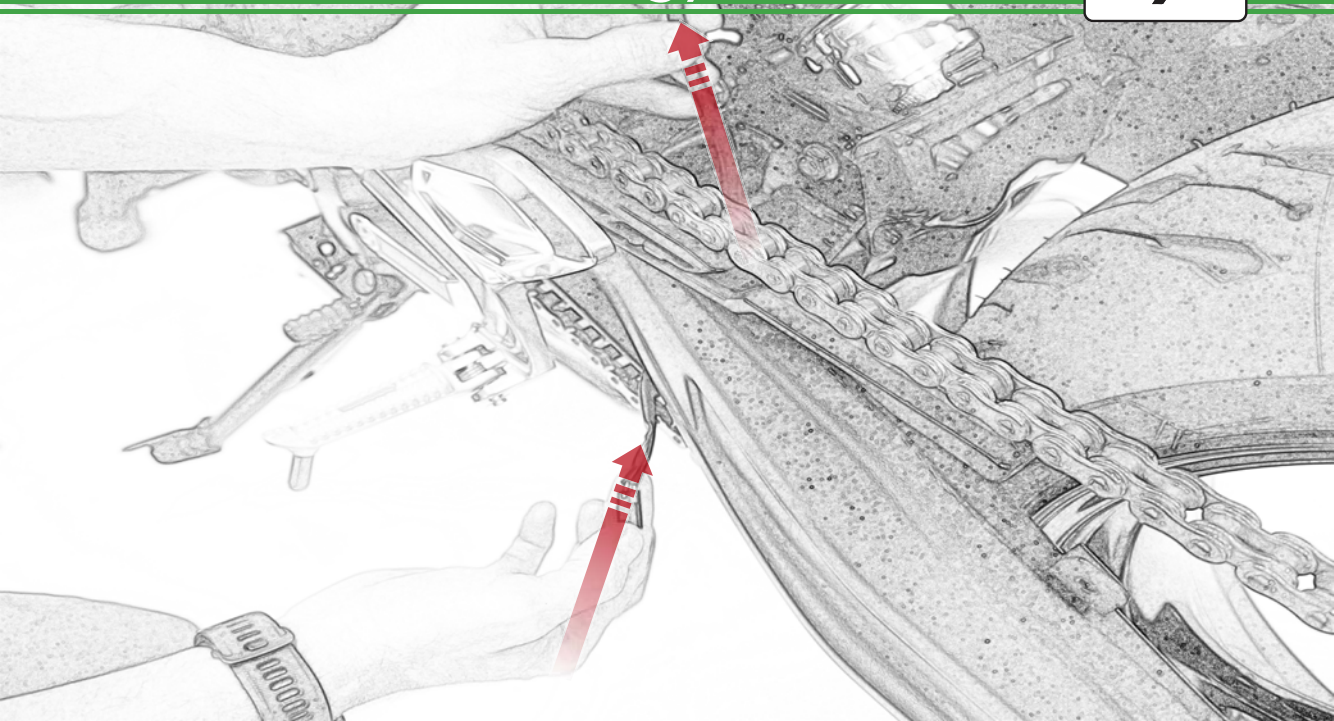

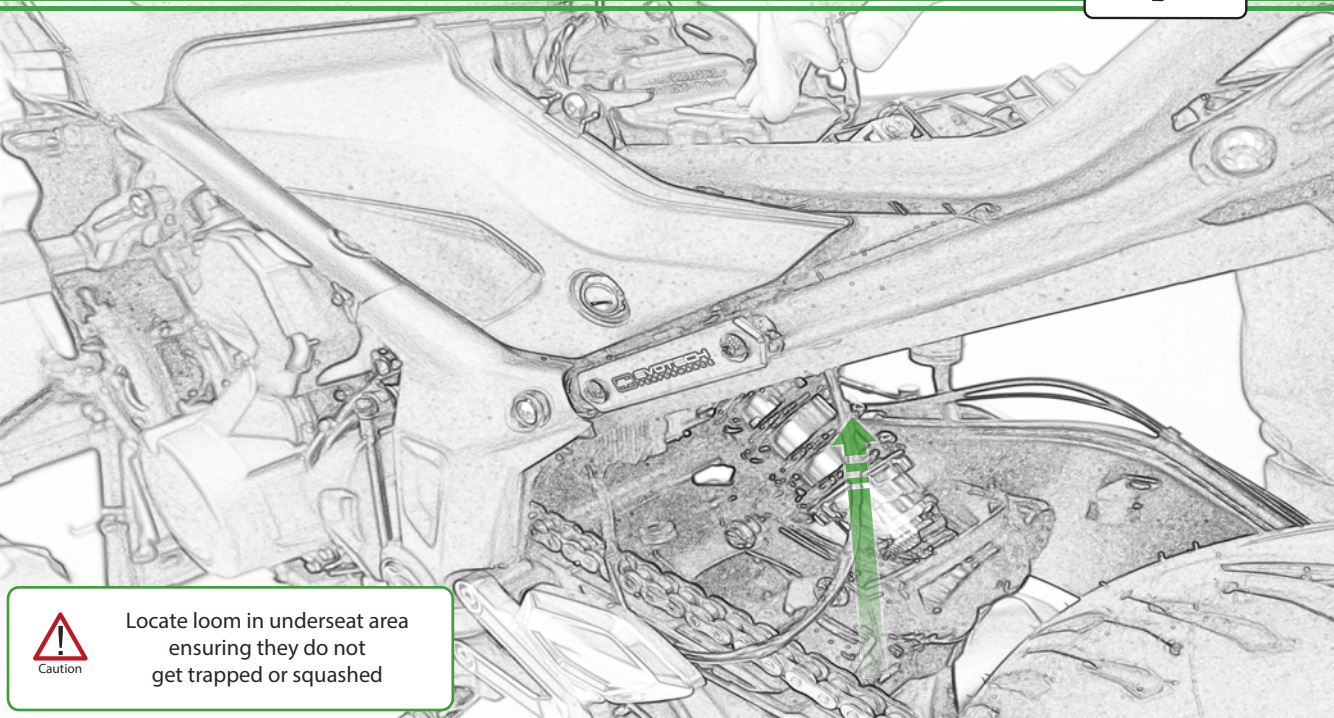

Caution

Locate loom in underseat area  
ensuring they do not  
get trapped or squashed

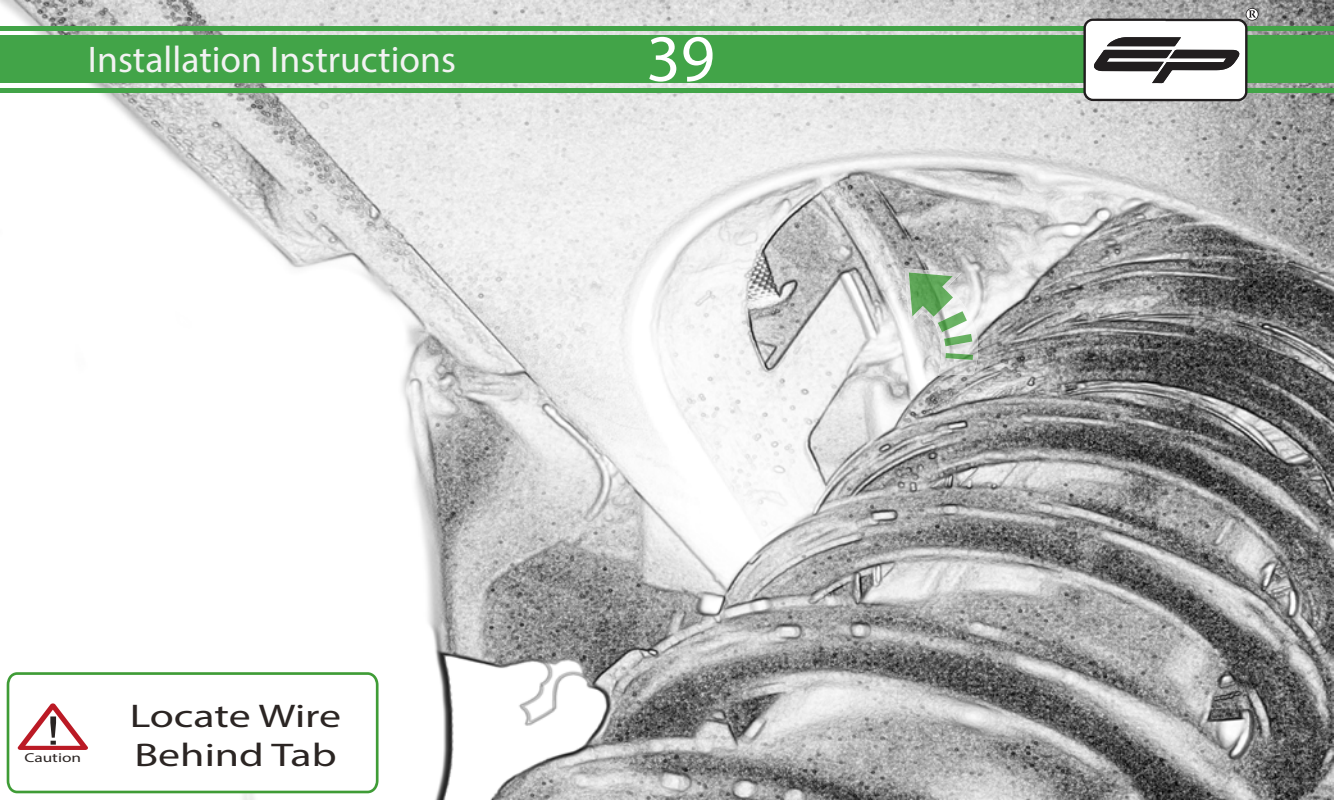

Caution

Locate Wire  
Behind Tab





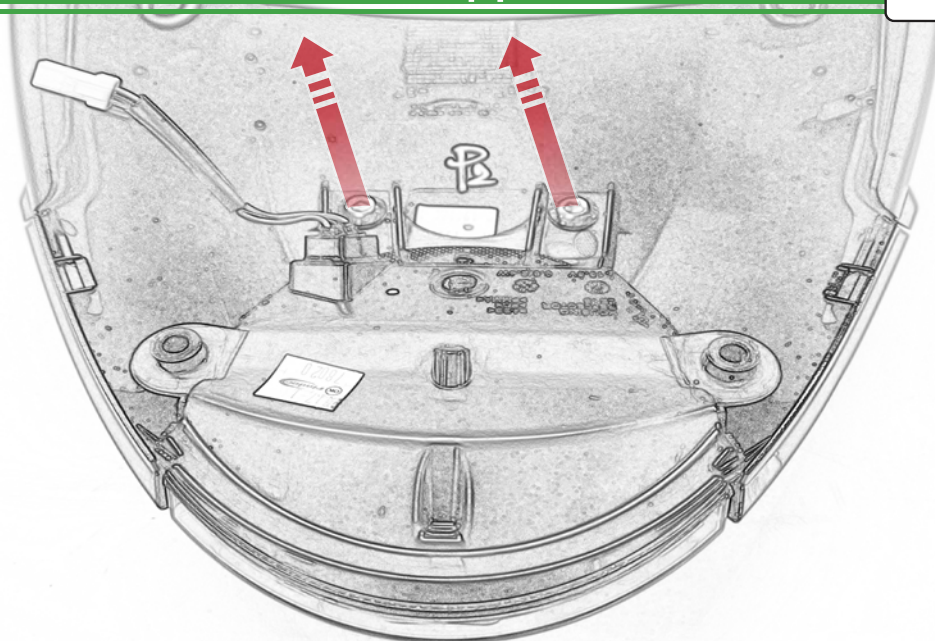





A

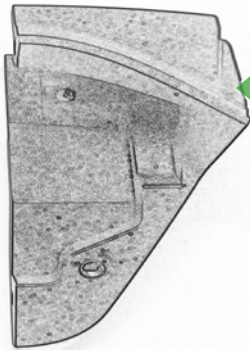
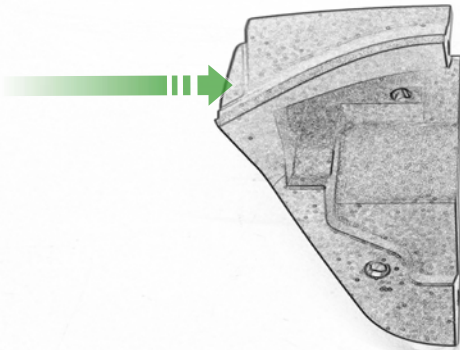
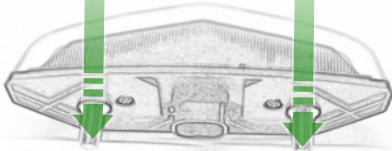

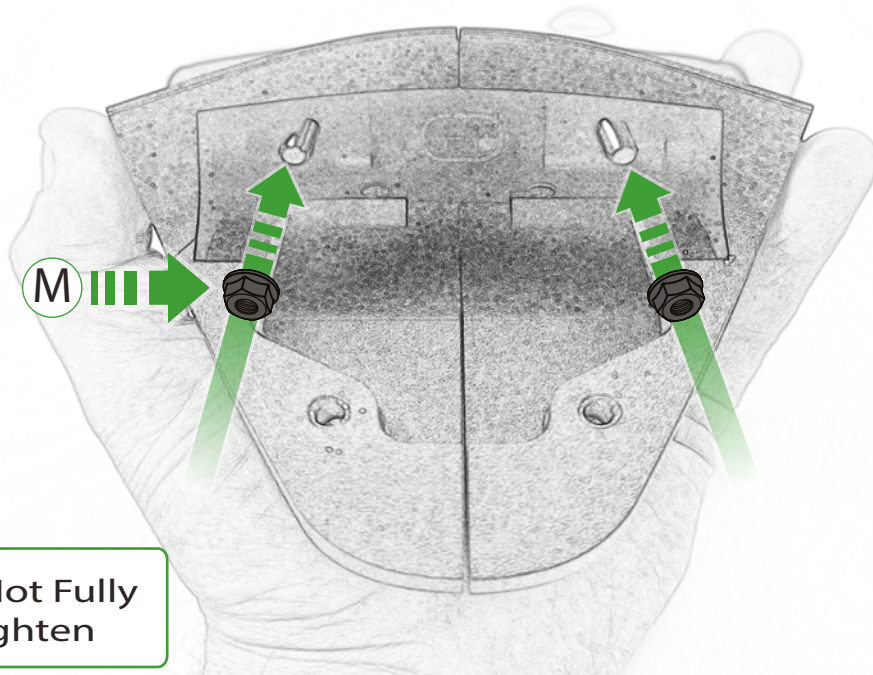

M



Do Not Fully Tighten

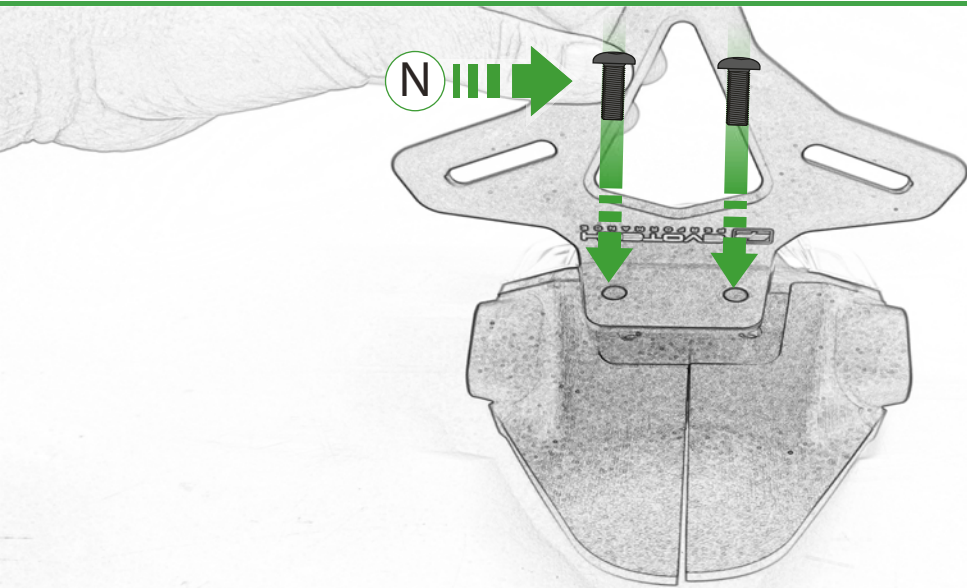

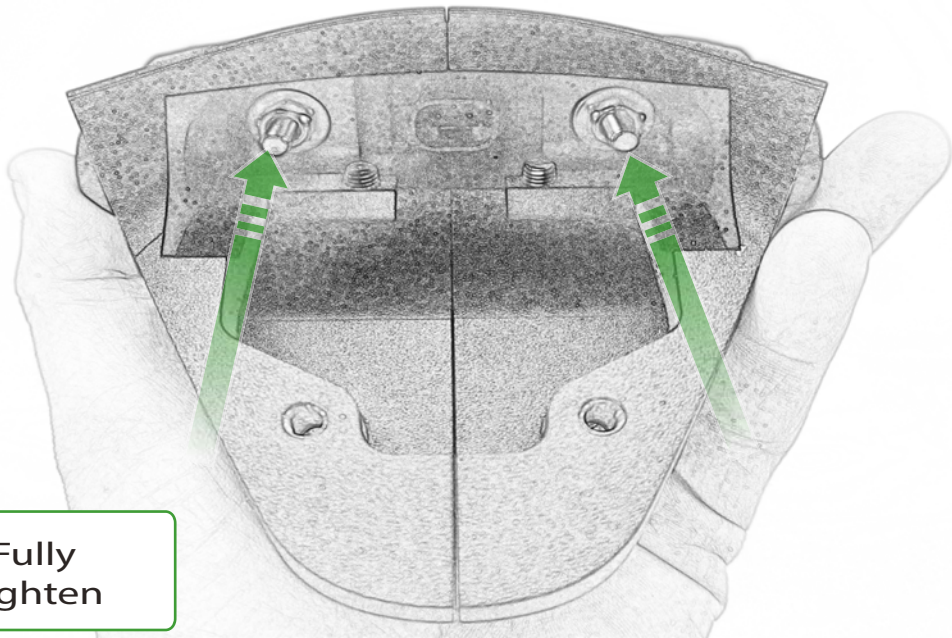

Caution

Fully  
Tighten

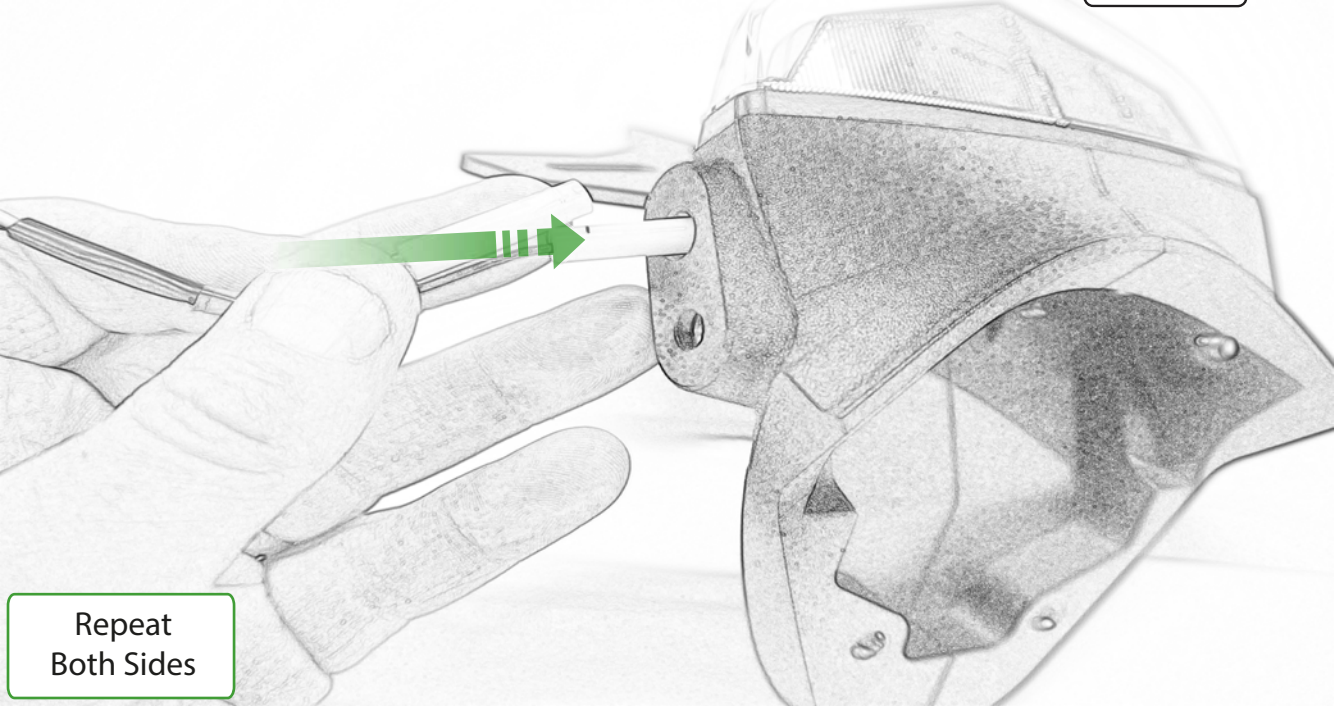

Repeat  
Both Sides



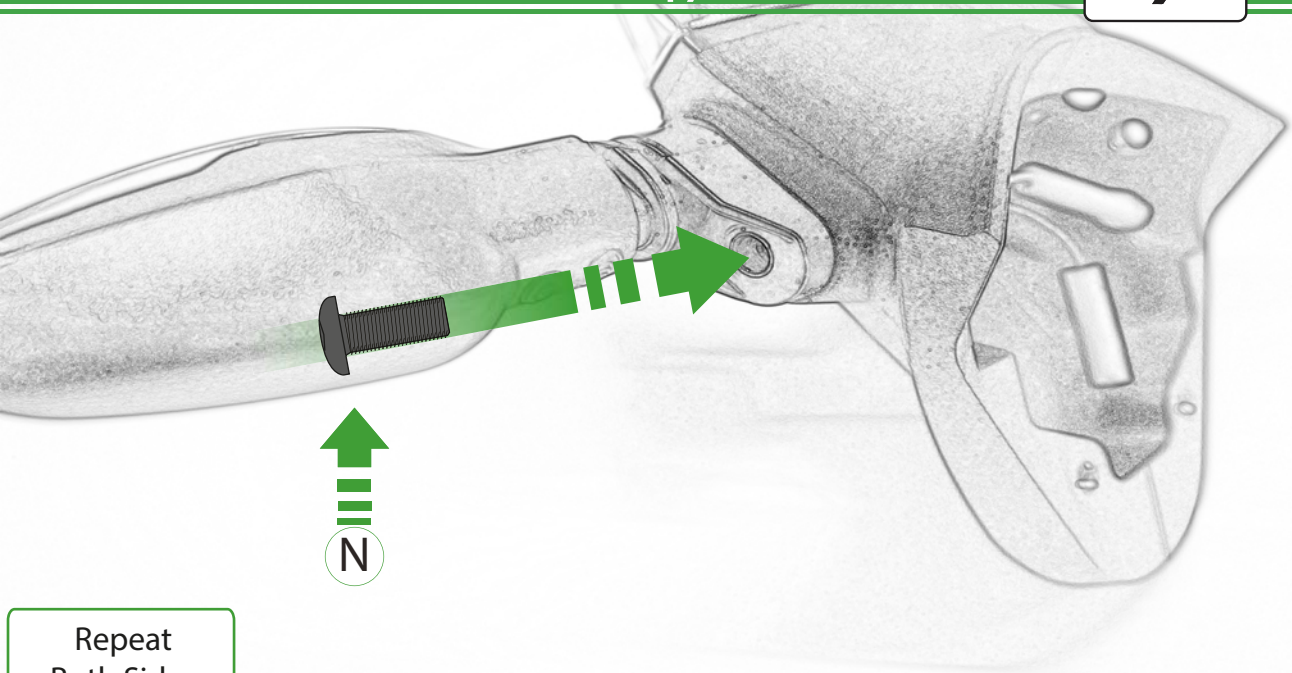

Repeat  
Both Sides

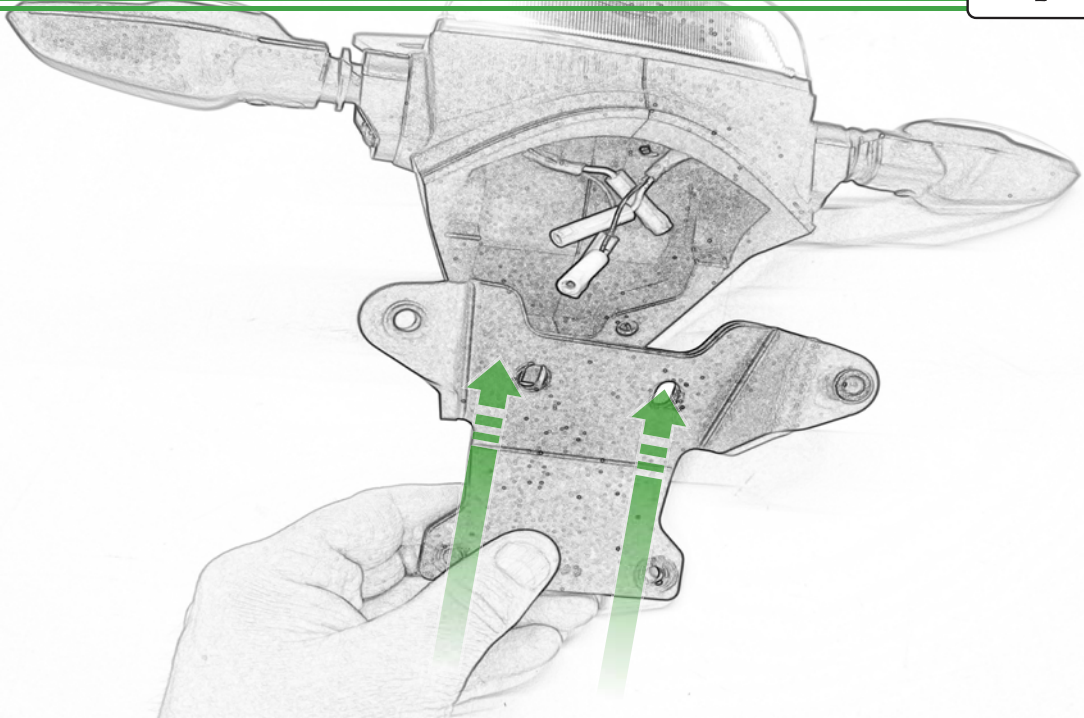

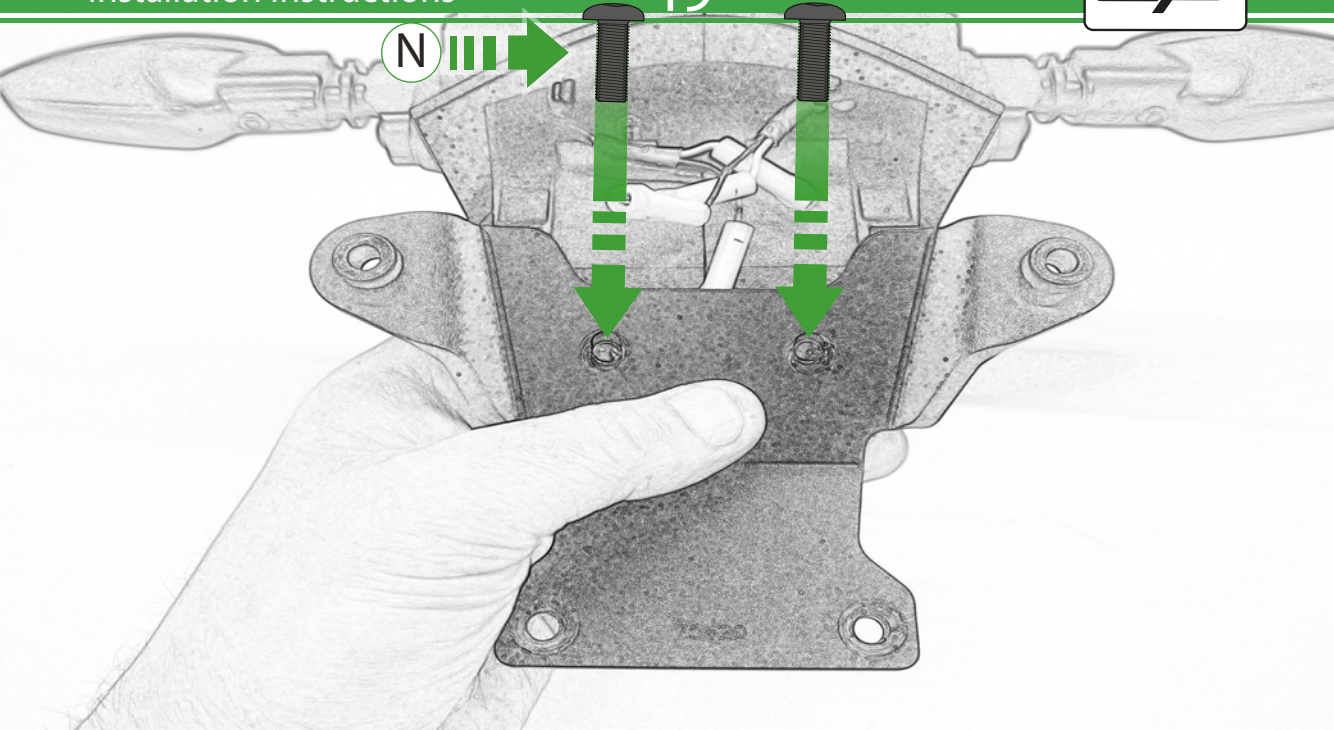

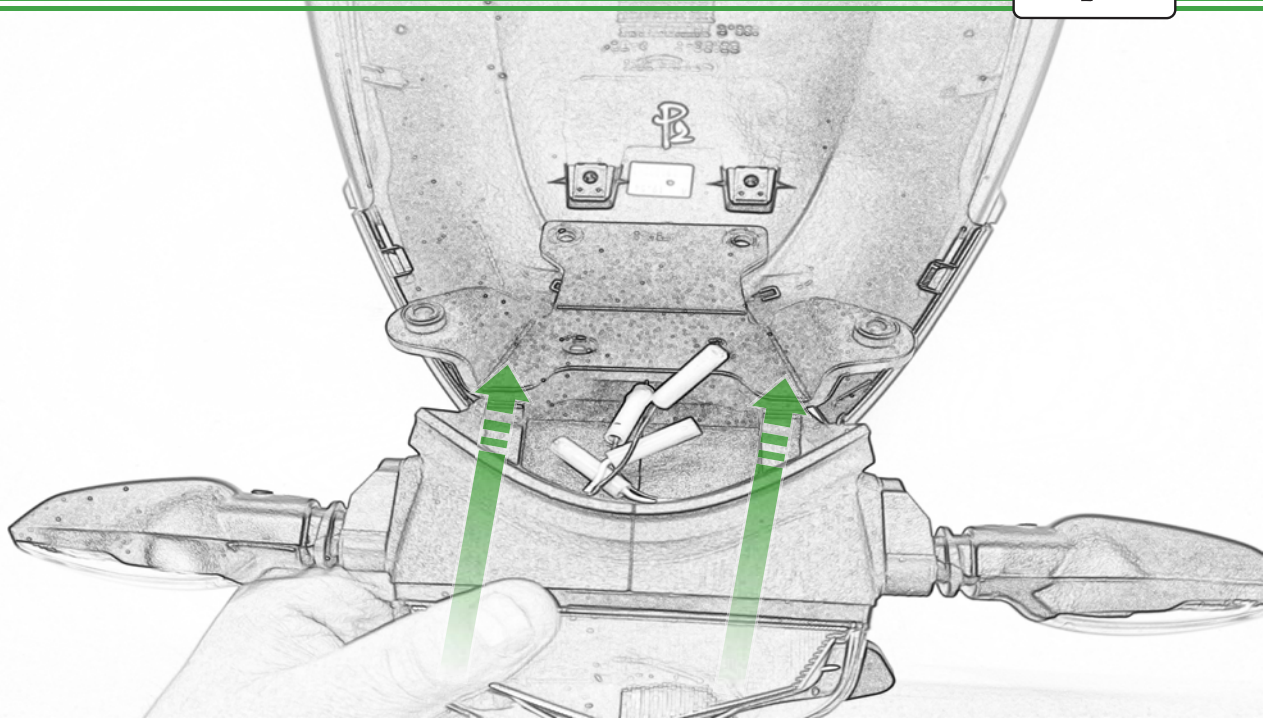



N

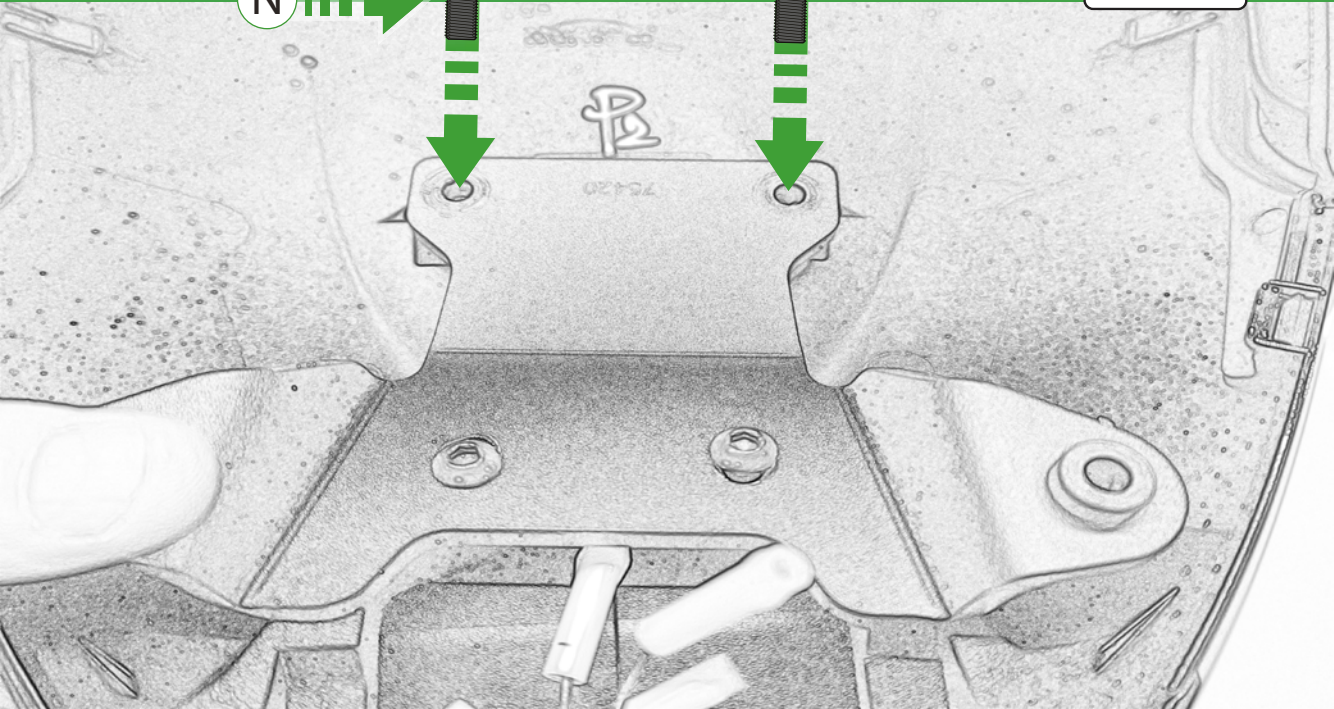

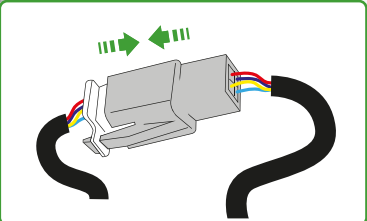
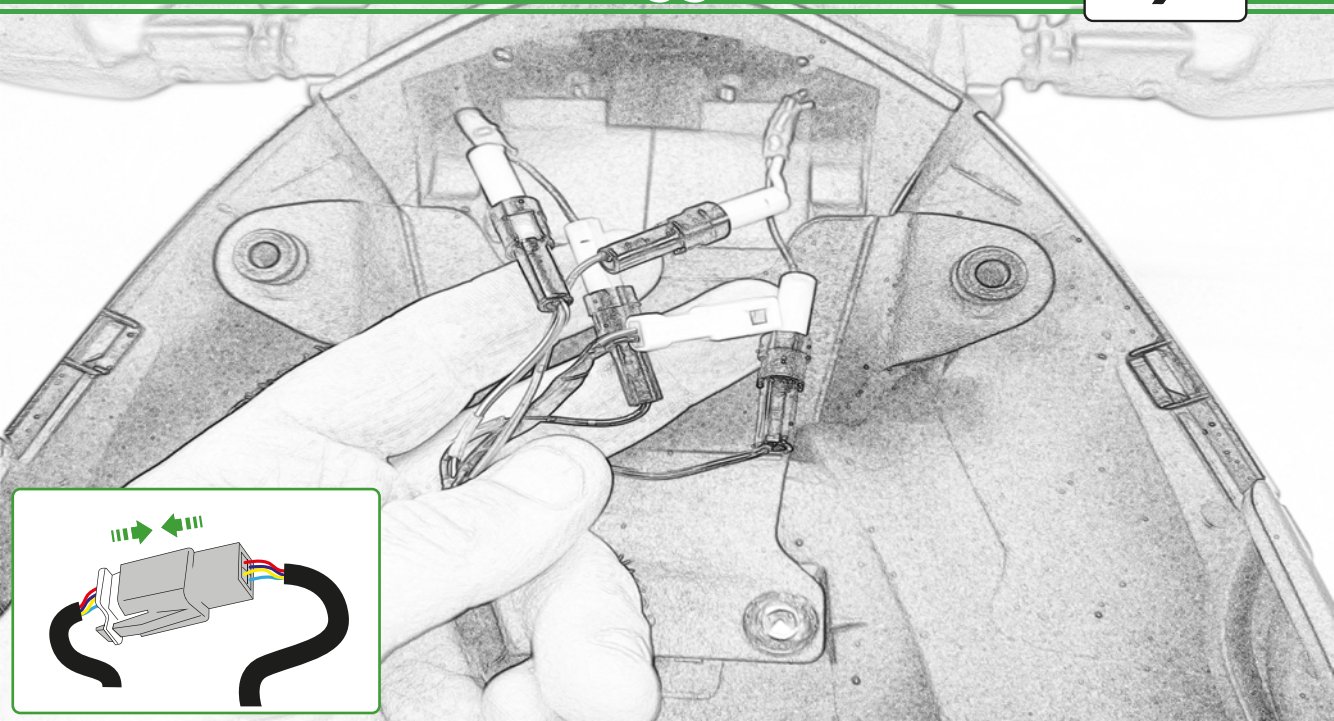

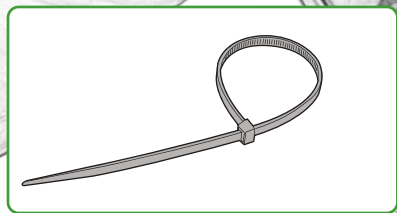
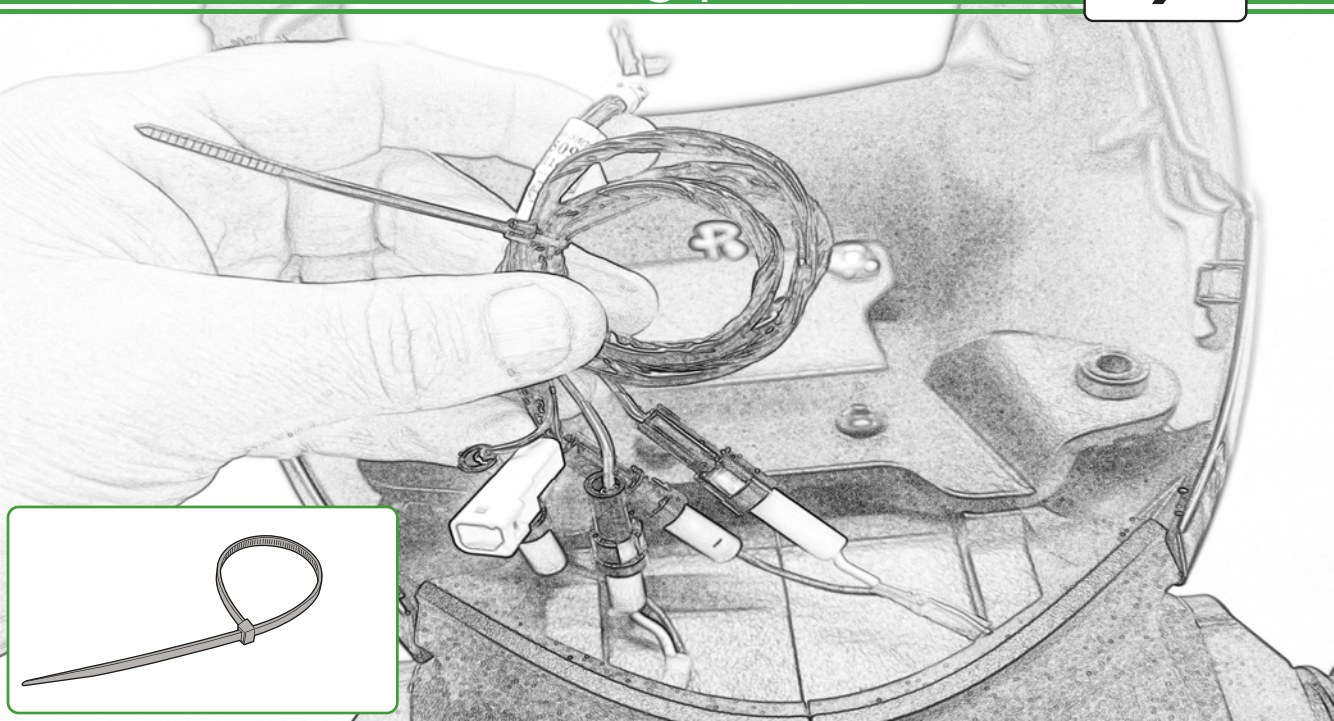

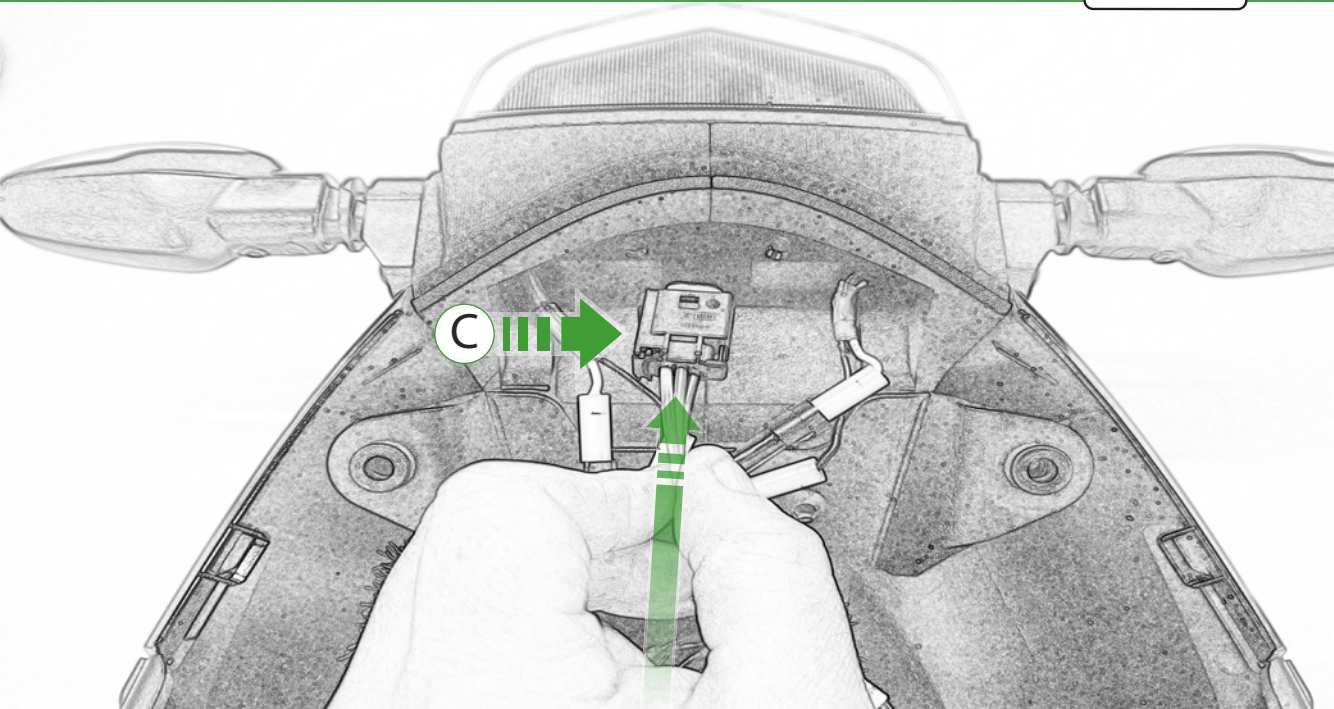

C





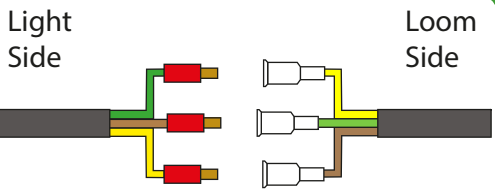
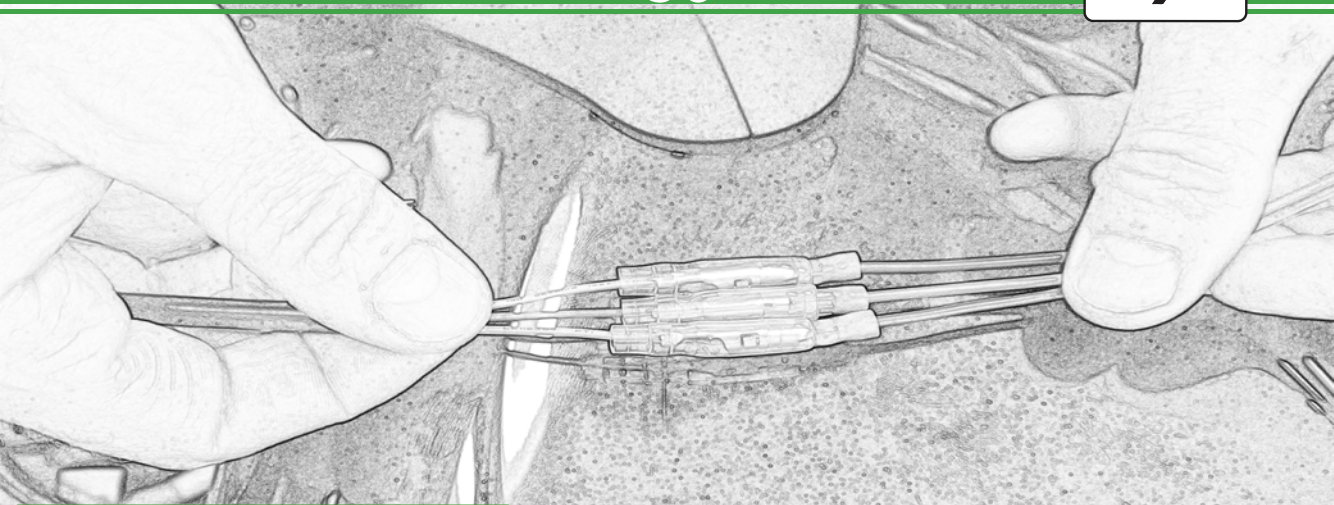

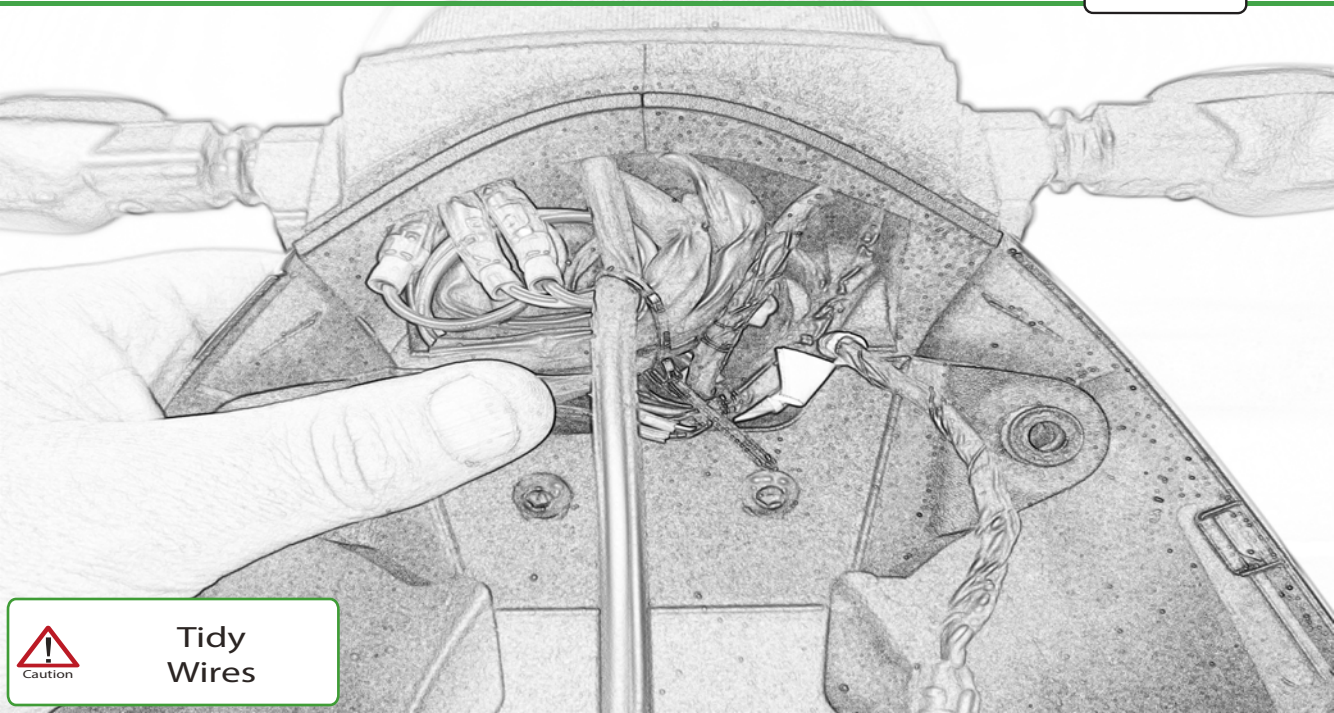

Tidy  
Wires

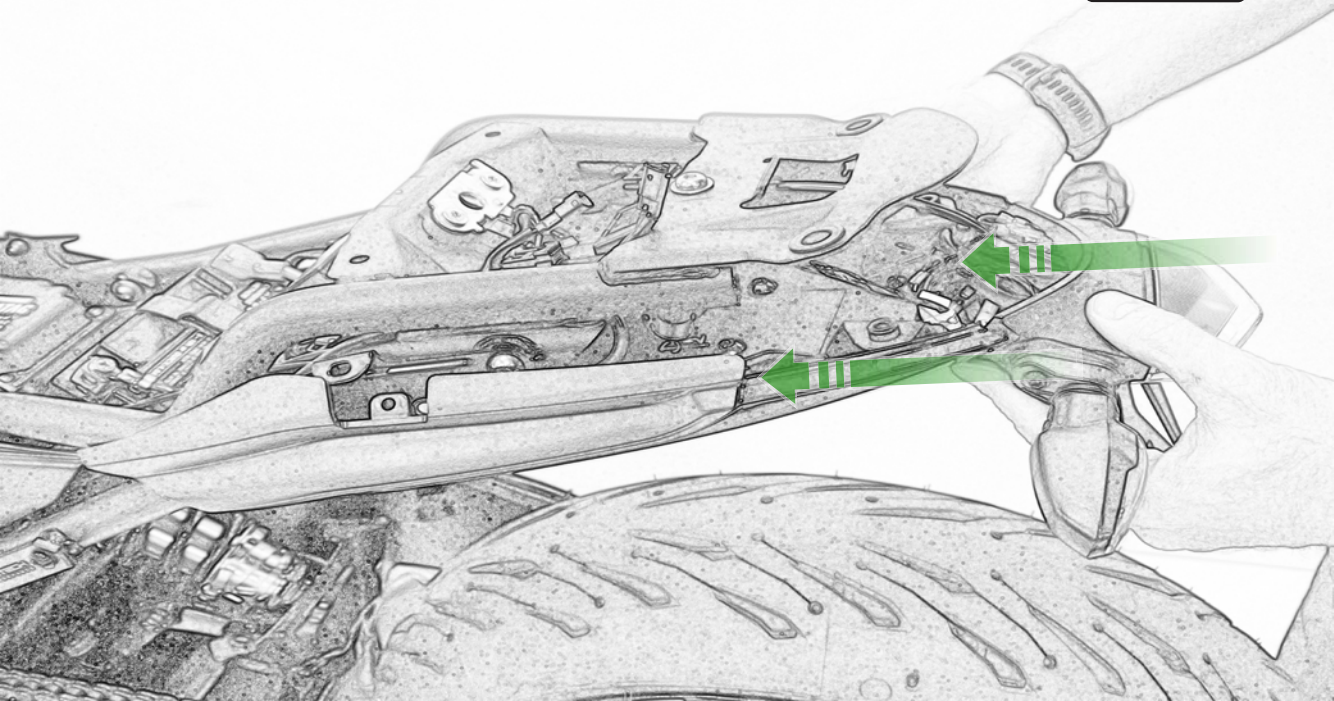

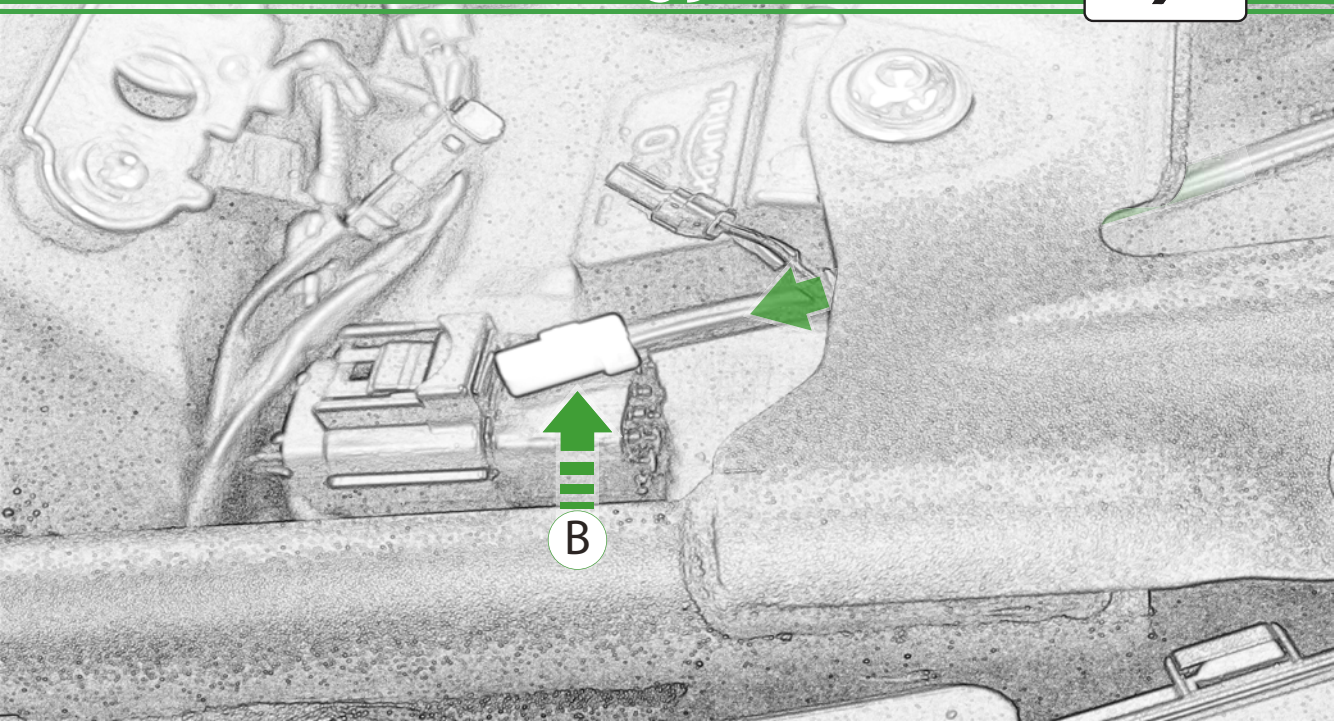



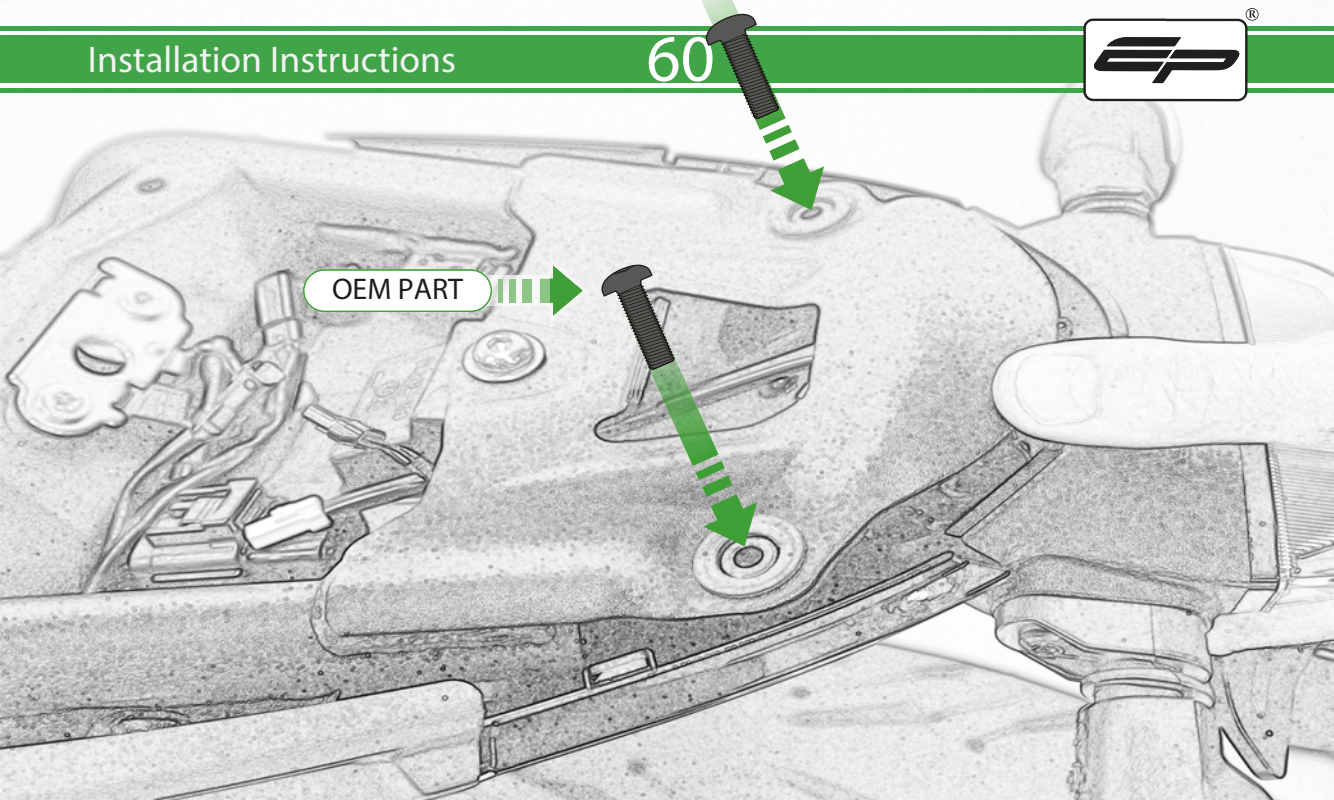

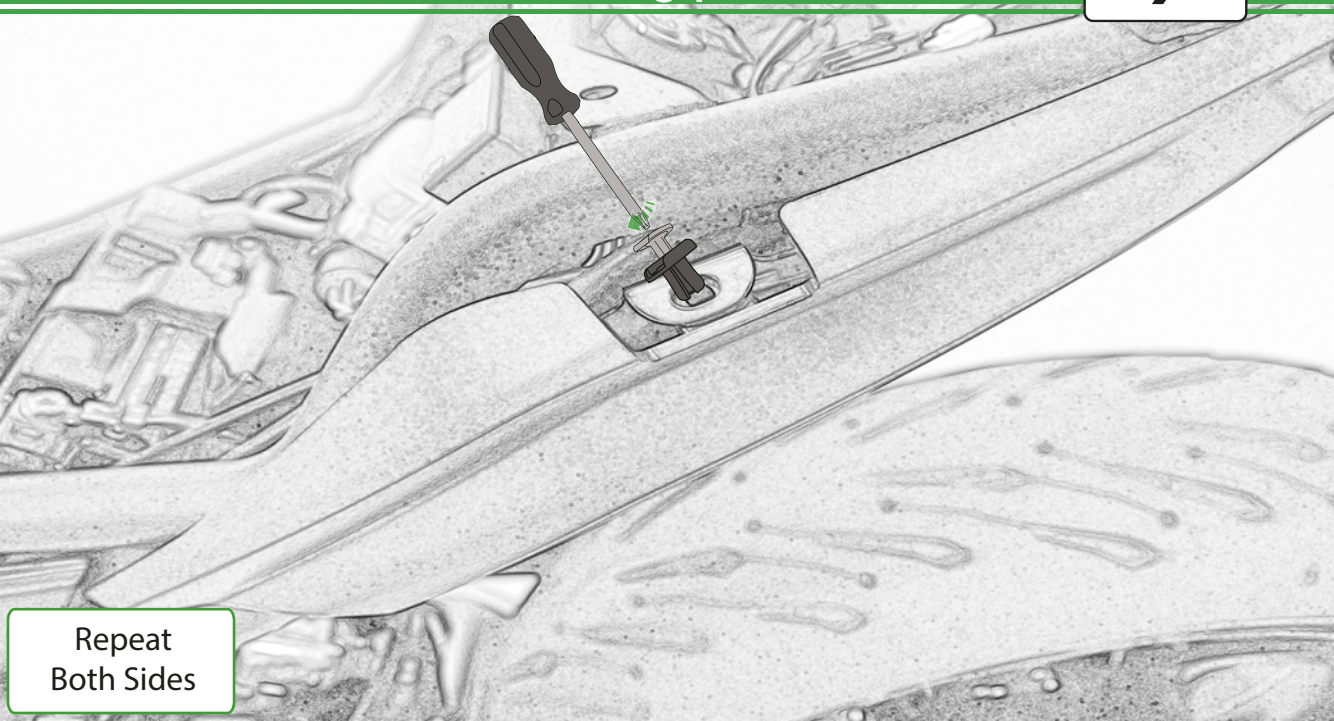

Repeat  
Both Sides



Fully  
Tighten

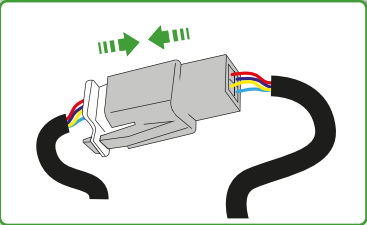
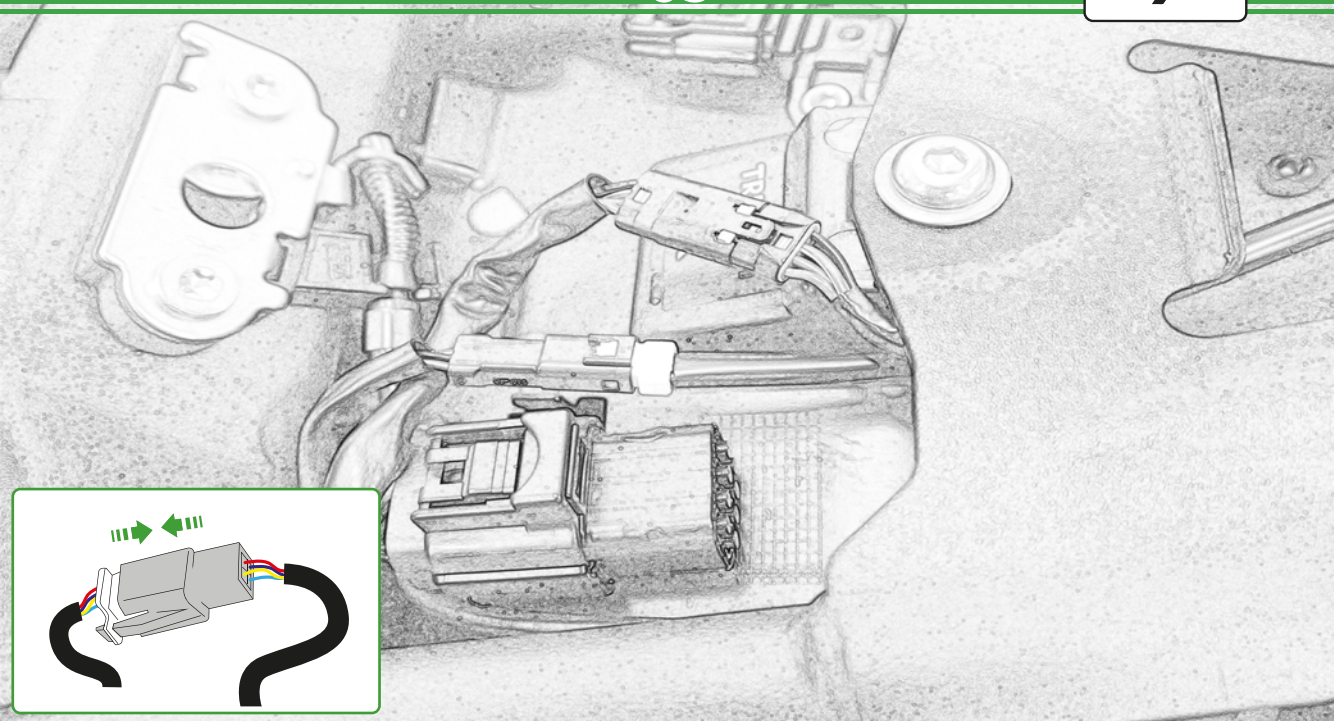





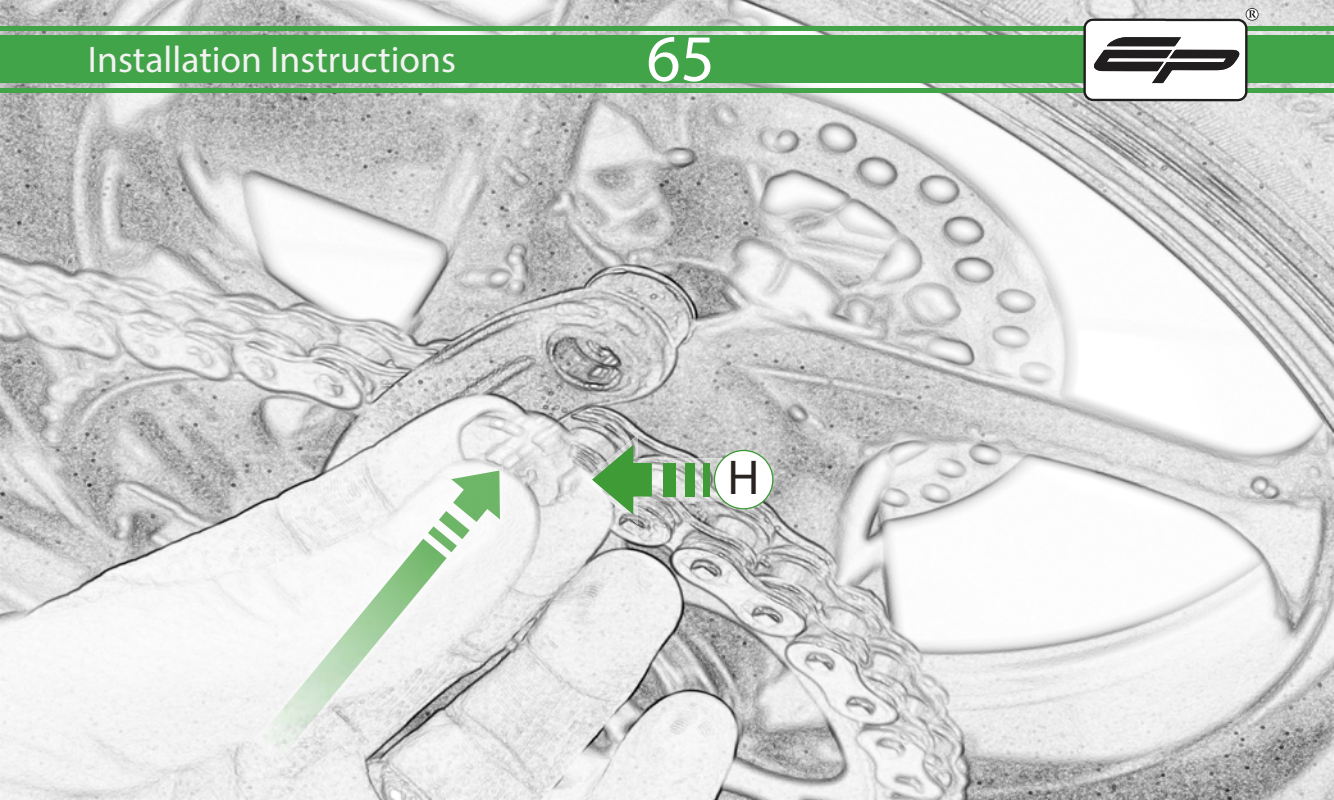

H

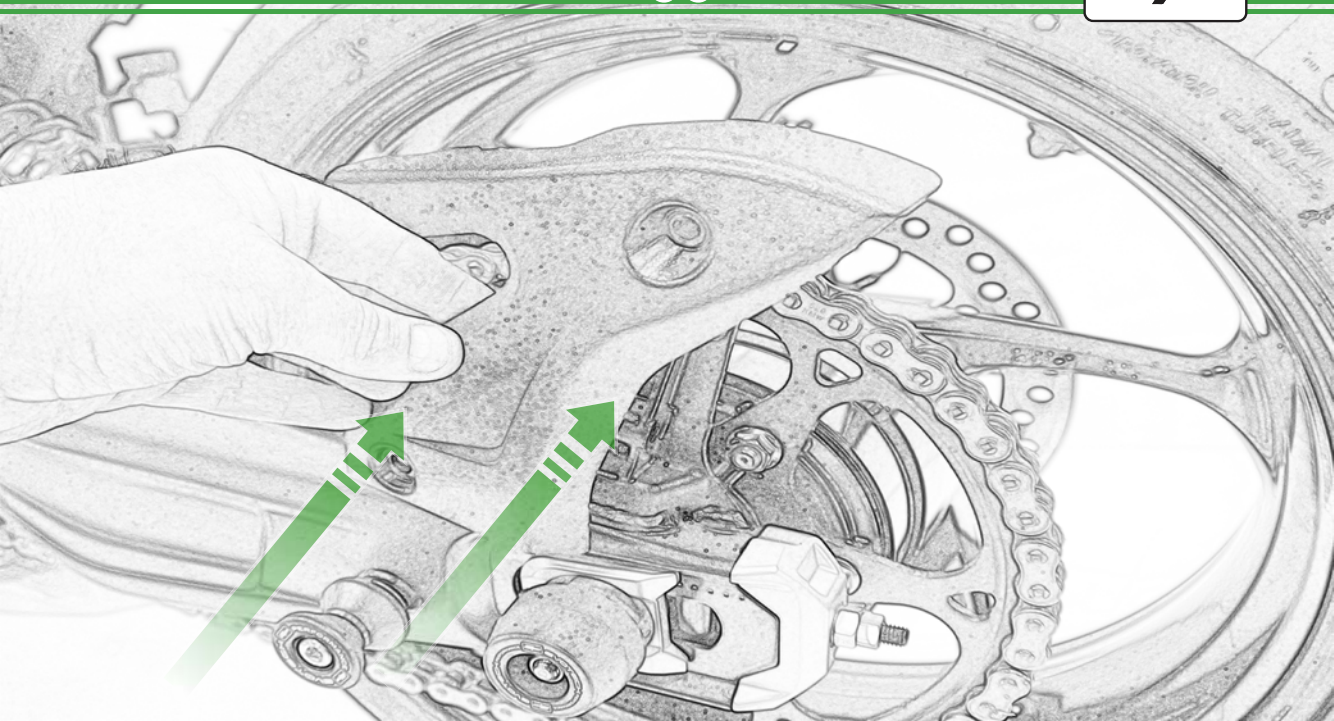



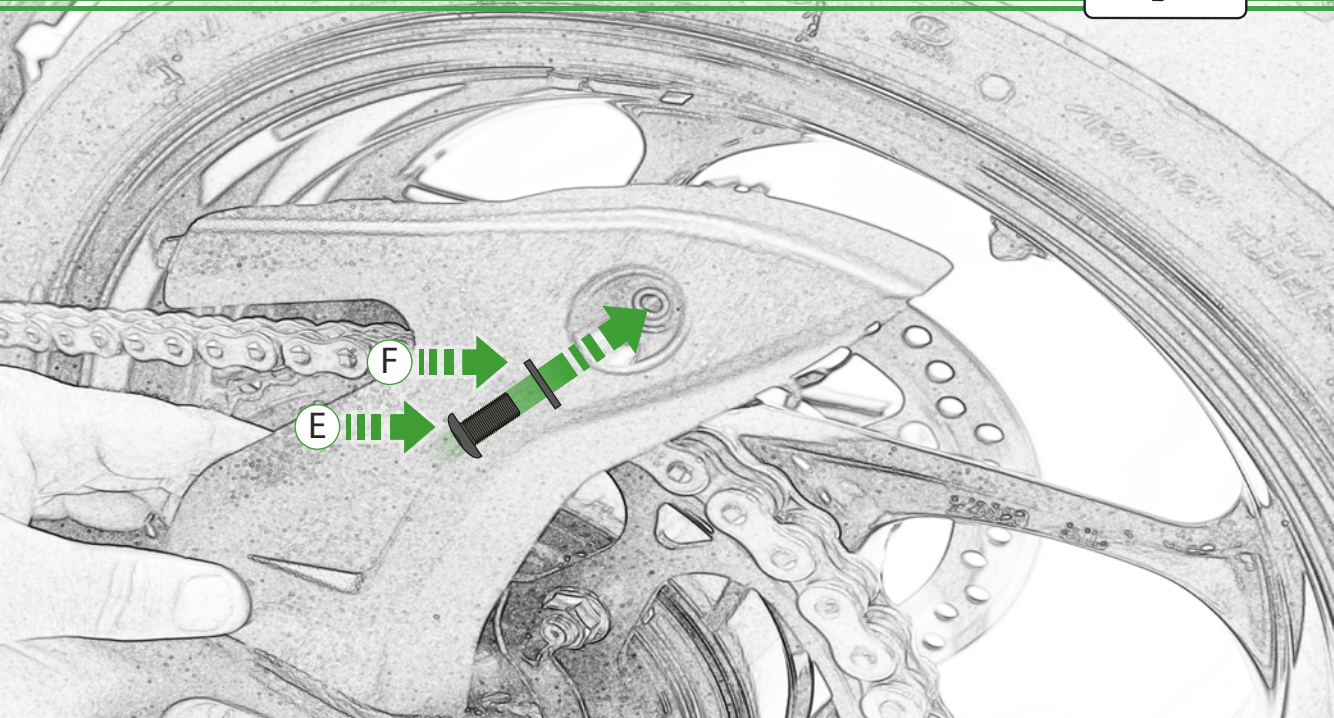



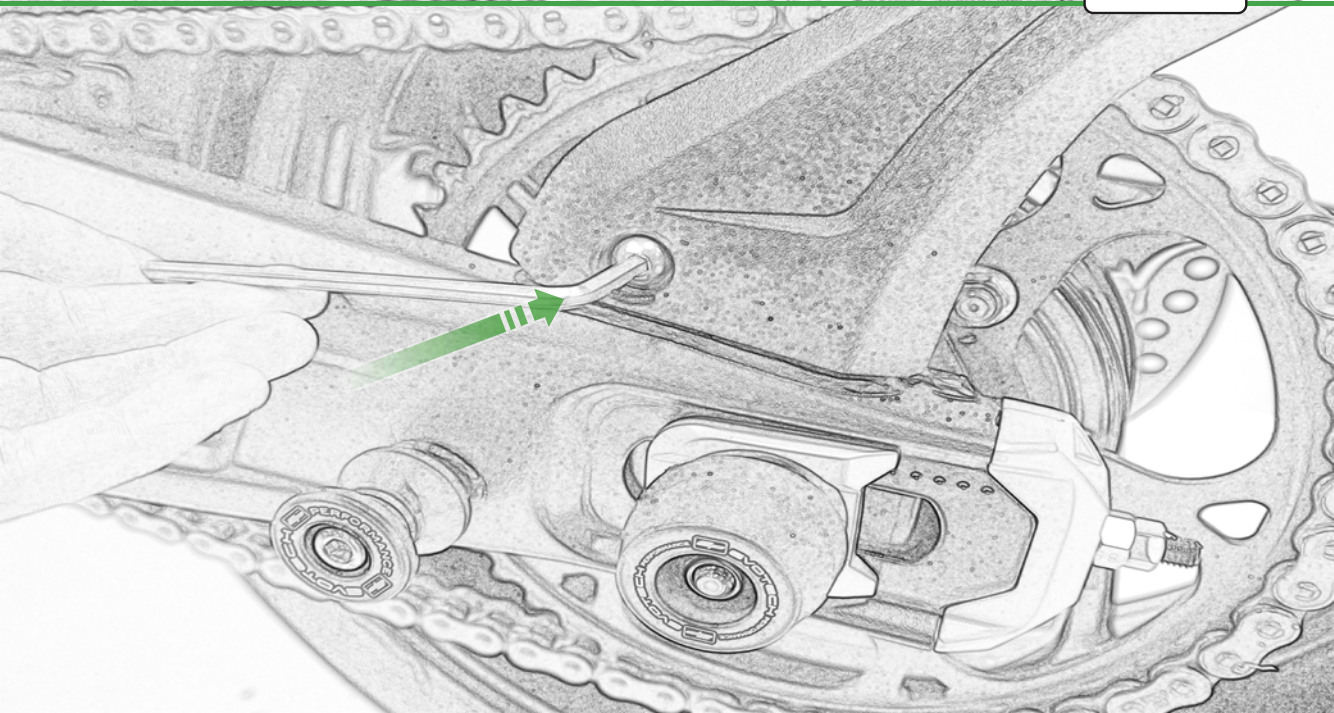

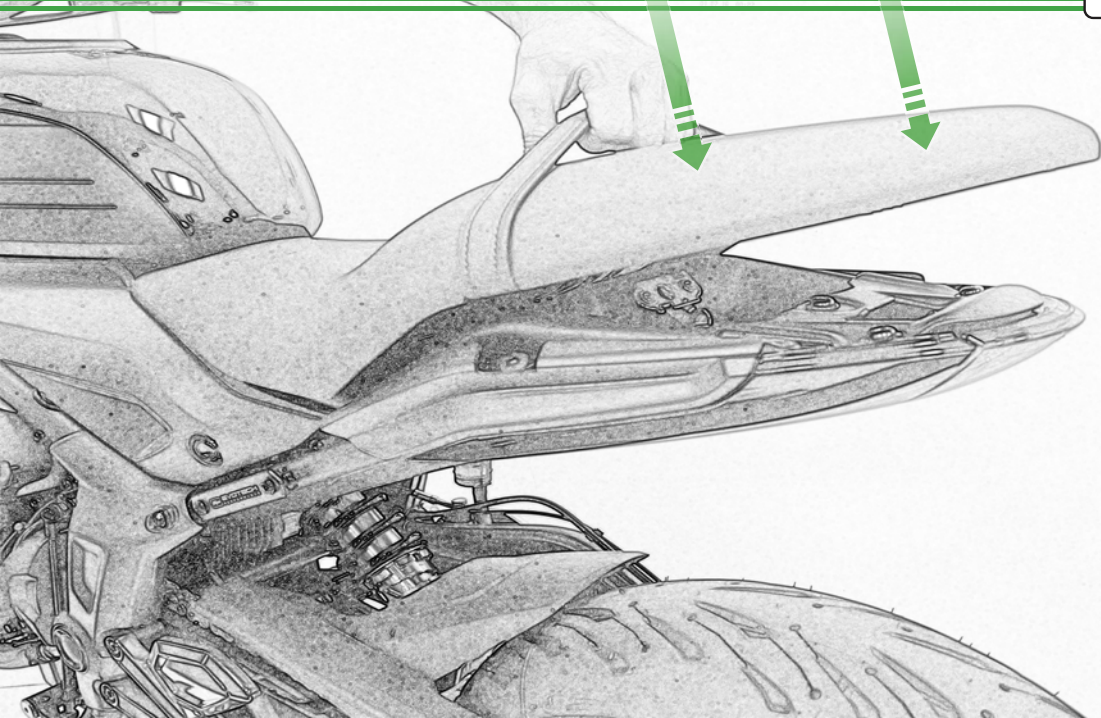



## ESSENTIAL CHECKS



After installation of your tail tidy ensure that the licence plate does not contact the rear tyre when suspension is fully compressed.

Ensure all electrics including indicators, tail light, brake light and licence plate light lights are working correctly before riding the motorcycle.

It is recommended that periodic inspections are made to ensure that all fixings are fully tightend.

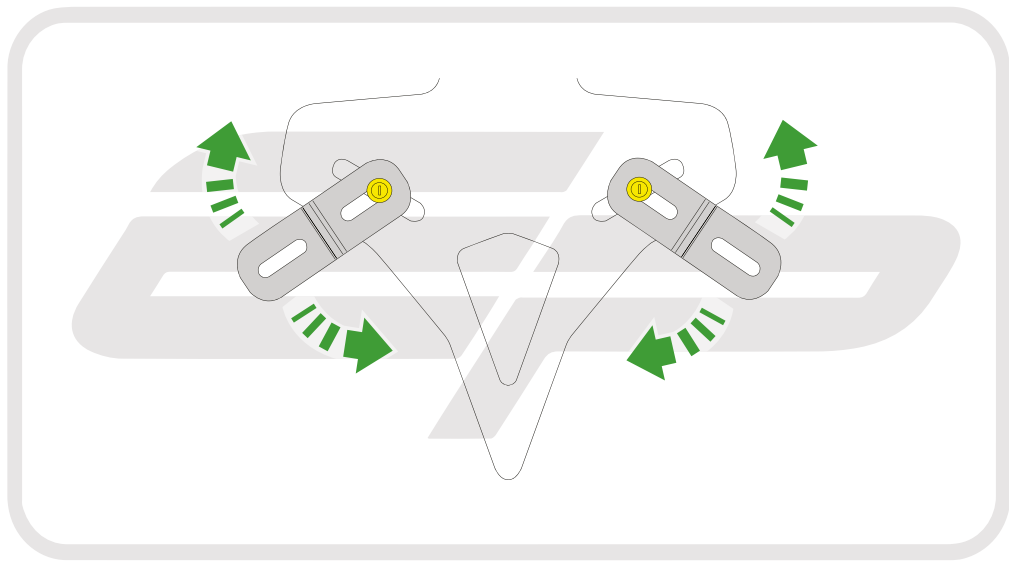



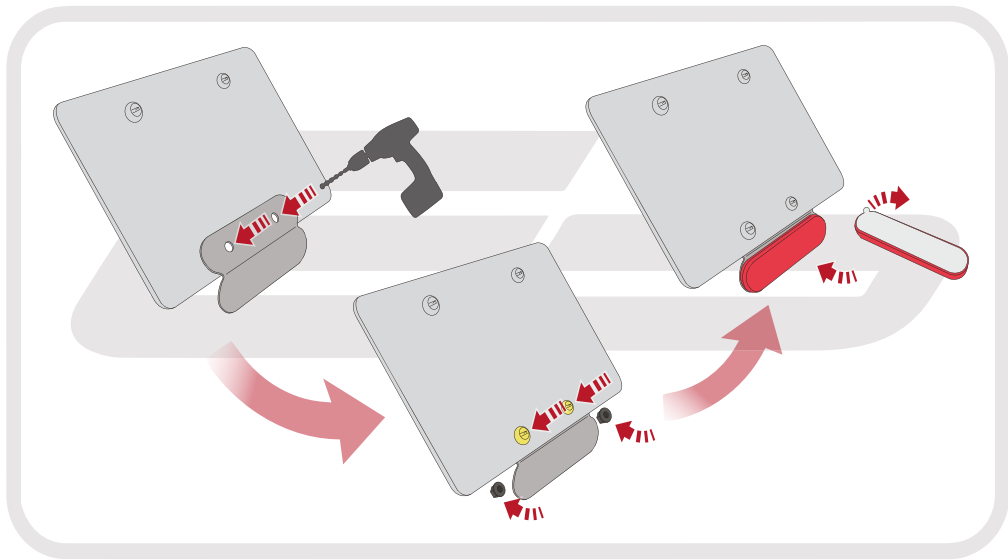



**EVOTECH**®  
P E R F O R M A N C E

[www.evotech-performance.com](http://www.evotech-performance.com)